



**MF275dw / MF272dw**

# **User's Guide**

# Contents

<b>About the Machine</b> .....	2
<b>Supported Functions and Options</b> .....	3
TELEPHONE 6 KIT .....	5
<b>System Manager ID and PIN</b> .....	6
<b>Measures to Prevent Unauthorized Access</b> .....	7
<b>Names of Parts and Their Functions</b> .....	9
Front Side .....	10
Rear Side .....	12
Interior .....	13
Operation Panel .....	14
Feeder .....	17
Paper Drawer .....	18
<b>Usable Paper</b> .....	19
Precautions When Handling Paper .....	22
<b>Specifications</b> .....	23
Basic Specifications .....	24
Feeder Specifications .....	27
Print Specifications .....	28
Scan Specifications .....	29
Fax Specifications .....	30
Network Specifications .....	31
Security and Management Function Specifications .....	32
Supported Environment .....	35
<b>Recommended Functions</b> .....	36
Digitizing Documents .....	37
Cost Savings .....	38
Making Operations More Efficient .....	39
<b>Setting Up</b> .....	41
<b>Configuring the Default Settings (Setup Guide) (Touch Panel Model)</b> .....	43
<b>Configuring the Default Settings (Setup Guide) (5 Lines LCD Model)</b> .....	46
<b>Setting Up the Network</b> .....	49
Selecting Wired or Wireless LAN .....	51
Connecting to a Wired LAN .....	53
Connecting to a Wireless LAN .....	54
Connecting to a Wireless LAN by Using the Router Button (Push Button Mode) .....	57
Connecting to a Wireless LAN by Entering a PIN Code (WPS PIN Code Mode) .....	59
Connecting to a Wireless LAN by Searching for a Router (Access Point Setup Method) .....	62
Connecting to a Wireless LAN by Setting the Details (Manual Setup Method) .....	65
Setting IPv4 Addresses .....	70
Setting IPv6 Addresses .....	74

Configuring Your Machine for Your Network Environment .....	76
Manually Configuring the Ethernet Settings .....	77
Configuring DNS .....	78
Configuring SMB .....	81
Configuring WINS .....	82
Configuring SNMP .....	83
Configuring SNTTP .....	86
Checking the Network Status and Settings .....	88
<b>Configuring the Fax Settings (Fax Setup Guide) (Touch Panel Model) .....</b>	<b>94</b>
<b>Installing Software and Drivers to the Computer .....</b>	<b>98</b>

## **Basic Operations** ..... 101

<b>Turning ON and OFF the Machine</b> .....	102
Turning ON the Machine .....	103
Turning OFF the Machine .....	104
Restarting the Machine .....	106
<b>Reducing Power Consumption (Sleep Mode)</b> .....	107
<b>Using the Operation Panel</b> .....	109
Screens Displayed on the Operation Panel .....	110
[Home] Screen .....	113
[Status Monitor] Screen .....	116
How to Operate the Operation Panel (Touch Panel Model) .....	118
How to Operate the Operation Panel (5 Lines LCD Model) .....	120
Entering Characters .....	122
Customizing the [Home] Screen .....	125
<b>Logging In to the Machine</b> .....	127
<b>Placing Originals</b> .....	129
<b>Loading Paper</b> .....	132
Loading Paper in the Paper Drawer .....	133
Preparations and Orientation for Loading Envelopes .....	135
Orientation for Loading Paper with a Logo .....	137
Specifying the Paper Size and Type .....	139
Setting the Paper Size and Type for the Paper Drawer .....	140
Registering Non-standard Size Paper (Custom Paper) .....	143
Hiding Unused Paper Sizes .....	145
<b>Registering Destinations (Address Book) (Touch Panel Model)</b> .....	147
Address Book Function (Touch Panel Model) .....	148
Registering Destinations to the Address Book (Operation Panel) (Touch Panel Model) .....	150
Registering Groups to the Address Book (Operation Panel) (Touch Panel Model) .....	152
Editing and Deleting Destinations in the Address Book (Operation Panel) (Touch Panel Model) .....	154
Registering Destinations to the Address Book (Remote UI) (Touch Panel Model) .....	155
Registering Groups to the Address Book (Remote UI) (Touch Panel Model) .....	157
<b>Specifying Destinations (Touch Panel Model)</b> .....	159
Specifying Destinations (Address Book) (Touch Panel Model) .....	160
Specifying Destinations (Direct Input) (Touch Panel Model) .....	162

Specifying Destinations (TX Job Log) (Touch Panel Model) .....	163
<b>To change the default settings</b> .....	164
Changing the Default Settings .....	165
<b>Adjusting the Sound Volume (Touch Panel Model)</b> .....	167
Adjusting the Volume (Touch Panel Model) .....	168
[Volume Settings] Screen (Touch Panel Model) .....	171

## **Printing** ..... 173

<b>Printing Preparations</b> .....	174
Preparing to Print from a Computer .....	175
Configuring a Printer Port (Windows) .....	176
Setting Up a Print Server .....	179
<b>Printing from a Computer</b> .....	182
Registering Non-standard Size Paper to the Computer (Custom Size) .....	185
<b>Canceling Printing</b> .....	187
<b>Viewing the Print Job Status and Log</b> .....	190

## **Scanning** ..... 193

<b>Preparing to Save Scanned Data to a Computer</b> .....	194
<b>Scanning (Saving to a Computer)</b> .....	196
<b>Scanning Using the Shortcut Key</b> .....	199
<b>Scanning from a Computer</b> .....	203
Starting MF Scan Utility .....	206
<b>Canceling Scanning</b> .....	207
<b>Checking the Save Status and Log of Scanned Data (Touch Panel Model)</b> .....	209

## **Faxing** ..... 211

<b>Preparing to Send and Receive Faxes</b> .....	212
Preparing to Send Faxes from a Computer .....	213
Changing Fax RX Mode and Setting the Action when Receiving a Fax .....	215
Changing the Fax Number and Unit Name .....	217
<b>Forwarding Faxes and Configuring the Backup Settings</b> .....	218
Auto Forwarding and Backing Up Received Faxes .....	219
<b>Sending Faxes</b> .....	221
Sending a Fax after a Phone Conversation (Manual Sending) .....	223
<b>Sending Faxes from a Computer (PC Faxing)</b> .....	225
Securely Sending PC Faxes .....	228
<b>Fax Original Scan Settings</b> .....	229
<b>Receiving Faxes</b> .....	231
Receiving Faxes via Telephone (Remote RX) .....	232
Changing the Print Settings for Received Faxes .....	233
<b>Canceling Fax Sending</b> .....	235
<b>Checking the Status and Log for Sent and Received Faxes</b> .....	236

<b>Copying</b> .....	<b>239</b>
<b>Copy Operations</b> .....	<b>240</b>
<b>Additional Copying Features (Touch Panel Model)</b> .....	<b>244</b>
<b>Additional Copying Features (5 Lines LCD Model)</b> .....	<b>250</b>
<b>Using Paper Save Copy</b> .....	<b>256</b>
<b>Copying Both Sides of ID Cards onto One Sheet</b> .....	<b>260</b>
<b>Copying Multiple Passports onto One Sheet</b> .....	<b>264</b>
<b>Canceling Copy Operations</b> .....	<b>268</b>
<b>Checking the Copy Status</b> .....	<b>270</b>
<b>Linking with Mobile Devices and Integrating with a Cloud Service</b> .....	<b>273</b>
<b>Preparations for Linking with Mobile Devices and Integrating with a Cloud Service</b> .....	<b>274</b>
Preparations for Direct Connection .....	275
Preparations for Using Universal Print .....	278
Registering the Machine to Azure Active Directory .....	279
Registering the Machine to the Computer .....	282
Preparations for Using AirPrint .....	283
<b>Connecting a Mobile Device to the Machine</b> .....	<b>286</b>
Connecting a Mobile Device via Wireless LAN Router (LAN Connection) .....	287
Connecting a Mobile Device Directly to the Machine (Direct Connection) .....	288
<b>Using a Dedicated Application to Print and Scan (Canon PRINT Business)</b> .....	<b>291</b>
<b>Printing with Universal Print</b> .....	<b>292</b>
<b>Using AirPrint Application to Print and Scan Data and Send Faxes</b> .....	<b>293</b>
<b>Printing from an Android Device</b> .....	<b>297</b>
<b>Printing from Chromebook or Other Device with Chrome OS</b> .....	<b>298</b>
<b>Security</b> .....	<b>300</b>
<b>Setting the Department ID and PIN for the Administrator</b> .....	<b>301</b>
<b>Protecting the Network</b> .....	<b>303</b>
Setting the Firewall .....	304
Changing the Port Number .....	307
Using a Proxy .....	308
Using TLS .....	310
Using IEEE 802.1X .....	312
Managing and Verifying a Key and Certificate .....	314
Generating a Key and Certificate .....	315
Generating a Key and Certificate Signing Request (CSR) and Obtaining and Registering a Certificate .....	317
Registering a Key and Certificate or CA Certificate Obtained from an Issuing Authority .....	320
Verifying a Received Certificate with OCSP .....	322
<b>Preventing Sending Data by Mistake and Leaking Information</b> .....	<b>323</b>
Limiting Available Destinations .....	324
Confirming the Destination before Sending .....	326
Restricting Fax Sending .....	328

Restricting Printing (Touch Panel Model) .....	330
Saving Received Documents in the Machine (Memory Lock) (Touch Panel Model) .....	331
<b>Preventing Unauthorized Use</b> .....	334
Restricting Address Book Registration and Editing (Touch Panel Model) .....	335
Restricting Use of Remote UI .....	337
Restricting Use from a Mobile Device .....	340
Preventing Connection to Computer via USB Port .....	341
Configuring LPD, RAW, or WSD .....	342
Disabling HTTP Communication .....	344

## Managing the Machine ..... 346

<b>Setting the Date and Time</b> .....	347
<b>Managing the Machine from a Computer (Remote UI)</b> .....	348
Starting Remote UI .....	349
Portal Page of Remote UI .....	351
Checking Usage and Logs with Remote UI .....	353
<b>Monitoring the Usage</b> .....	355
Checking the Number of Printed Pages (Check Counter) .....	356
Printing and Viewing Reports and Lists .....	358
Changing the Report and List Print Settings .....	361
<b>Importing and Exporting the Address Book (Touch Panel Model)</b> .....	363
<b>Updating the Firmware (Touch Panel Model)</b> .....	365
<b>Updating the Firmware (5 Lines LCD Model)</b> .....	368
<b>Initializing the Settings and Data</b> .....	371

## Settings Menu Items ..... 376

<b>[Preferences]</b> .....	377
[Display Settings] .....	379
[Timer/Energy Settings] .....	383
[Network] .....	386
[Wireless LAN Settings] .....	391
[TCP/IP Settings] .....	393
[External Interface] .....	400
[Accessibility] .....	401
[Volume Settings] (Touch Panel Model) .....	403
<b>[Adjustment/Maintenance]</b> .....	406
[Adjust Image Quality] .....	407
[Special Processing] .....	408
[Maintenance] .....	413
<b>[Function Settings]</b> .....	414
[Common] .....	415
[Paper Feed Settings] .....	416
[Print Settings] .....	417
[Scan Settings] .....	418
[Generate File] .....	419

[Copy] .....	420
[Printer] .....	422
[Printer Settings] .....	423
[PDL Selection (Plug and Play)] (Touch Panel Model) .....	429
[Send] .....	430
[Common Settings] (Touch Panel Model) .....	431
[Scan and Send Settings] .....	433
[Fax Settings] (Touch Panel Model) .....	435
[Receive/Forward] (Touch Panel Model) .....	441
[Common Settings] (Touch Panel Model) .....	442
[Fax Settings] (Touch Panel Model) .....	444
<b>[Set Destination] (Touch Panel Model)</b> .....	448
<b>[Management Settings]</b> .....	449
[User Management] .....	451
[Device Management] .....	452
[Remote UI Settings/Update Firmware] .....	455
[Remote UI Settings] .....	456
[Data Management] .....	457
[Security Settings] .....	458
[Authentication/Password Settings] .....	459

## **Maintenance** ..... 461

<b>Cleaning the Machine</b> .....	463
Cleaning the Surface of the Machine .....	464
Cleaning the Platen Glass .....	465
Cleaning the Feeder .....	466
Cleaning the Fixing Assembly .....	468
Cleaning the Drum .....	469
<b>Replacing Consumables</b> .....	470
Replacing the Toner Cartridge .....	471
Checking the Remaining Amount of Consumables .....	477
List of Consumables .....	478
<b>Adjusting the Print Density</b> .....	480
<b>Moving the Machine</b> .....	482

## **Troubleshooting** ..... 486

<b>Paper Jams</b> .....	487
Paper Jams in the Paper Drawer, Output Tray, and Rear Side .....	489
Paper Jams in the Feeder .....	493
Paper Jams That Occur Repeatedly .....	494
<b>Problems with Printing Results</b> .....	496
Toner Smudges and Splatters Appear .....	498
Streaks Appear .....	500
Printing Is Uneven .....	502
Printed Paper Is Blank .....	504

Smudge Marks Appear on the Edge of Printouts .....	505
Text or Images Are Blurry .....	506
Printouts Have Ghost Images .....	508
Printouts Are Faded .....	510
The Edge of the Page Is Not Printed .....	512
The Background Is Generally Dark .....	513
White Spots Appear .....	514
Smudge Marks Appear on the Back Side of Printouts .....	516
Printouts Are Skewed .....	517
The Printed Barcode Cannot be Scanned .....	518
<b>Paper and Paper Feeding Problems</b> .....	519
Paper Creases .....	520
Paper Curls .....	521
Paper Is Not Fed or Two or More Sheets Are Fed Together .....	522
Printed Paper Sticks Together .....	523
<b>Setting Up</b> .....	524
The Machine Connected via WSD Port Is Not Displayed During Driver Installation .....	525
Cannot Connect to Wireless LAN .....	526
<b>Network</b> .....	527
Cannot Switch to Wireless LAN .....	528
Cannot Find the Print Server to Connect to .....	530
Cannot Connect to a Shared Printer .....	531
Cannot Find the IP Address of the Machine .....	532
AirPrint Does Not Work .....	533
<b>Printing and Copying</b> .....	534
Cannot Print or Copy .....	535
Cannot Print (Wireless LAN) .....	536
Cannot Print (Wired LAN) .....	538
Cannot Print (USB Connection) .....	540
Cannot Print (via Print Server) .....	541
Printing Is Slow .....	542
<b>Scanning</b> .....	543
Cannot Save Scanned Data to a Computer .....	544
<b>Faxing and Using the Telephone</b> .....	546
Cannot Send a Fax .....	547
Cannot Receive a Fax .....	549
Machine Does Not Automatically Switch Between Telephone and Fax .....	551
Cannot Send or Receive a Fax via Optical Line .....	552
Cannot Send a Fax to an International Destination .....	553
Other Party's Telephone or Fax Number Is Not Displayed .....	554
<b>Management Functions and Environment Settings</b> .....	555
Cannot Access Remote UI .....	556
Changing the Time Until Sleep Mode .....	557
Lost Department ID or PIN for the Administrator .....	558



Checking the Items That Can Be Configured on the Machine and Their Settings .....	559
<b>A Message Appears</b> .....	560
<b>An Error Code Is Displayed</b> .....	575
<b>If the Problem Persists</b> .....	581
<b>Appendix</b> .....	<b>583</b>
<b>Manuals of the Machine</b> .....	584
<b>Using the User's Guide</b> .....	585
<b>Manual Display Settings</b> .....	588
<b>Operation Examples When Using a Computer</b> .....	589
<b>Environmental Information, Regulations, and Standards</b> .....	599
<b>Notice</b> .....	601
<b>Trademarks and Copyrights</b> .....	602
<b>Third-party Software</b> .....	604

# About the Machine

- About the Machine** ..... 2
- Supported Functions and Options** ..... 3
  - TELEPHONE 6 KIT ..... 5
- System Manager ID and PIN** ..... 6
- Measures to Prevent Unauthorized Access** ..... 7
- Names of Parts and Their Functions** ..... 9
  - Front Side ..... 10
  - Rear Side ..... 12
  - Interior ..... 13
  - Operation Panel ..... 14
  - Feeder ..... 17
  - Paper Drawer ..... 18
- Usable Paper** ..... 19
  - Precautions When Handling Paper ..... 22
- Specifications** ..... 23
  - Basic Specifications ..... 24
  - Feeder Specifications ..... 27
  - Print Specifications ..... 28
  - Scan Specifications ..... 29
  - Fax Specifications ..... 30
  - Network Specifications ..... 31
  - Security and Management Function Specifications ..... 32
  - Supported Environment ..... 35
- Recommended Functions** ..... 36
  - Digitizing Documents ..... 37
  - Cost Savings ..... 38
  - Making Operations More Efficient ..... 39

# About the Machine

---

94WS-000

Before using the machine, check the basic information of the machine such as the supported functions, and options, names of each part, and specifications of the functions. Also consider the management system of the machine and measures against security risks.

## Basic Information

The supported functions and options vary depending on the model. Check the list for details. You can also check the specifications of the options.

### ▶Supported Functions and Options(P. 3)

Check the names of parts, usable paper, and specifications of functions, as needed.

### ▶Names of Parts and Their Functions(P. 9)

### ▶Usable Paper(P. 19)

### ▶Specifications(P. 23)

## Information Required for Management Functions

When using the management functions, use the System Manager ID and PIN to log in. The preset System Manager ID and PIN vary depending on the model.

### ▶System Manager ID and PIN(P. 6)

When using the machine in a network environment, check the examples of measures to prevent unauthorized access, and consider implementing these.

### ▶Measures to Prevent Unauthorized Access(P. 7)

## Useful Tips

Introduces recommended functions useful for digitizing documents, reducing costs, and making operations more efficient.

### ▶Recommended Functions(P. 36)

# Supported Functions and Options

94WS-001

User's Guide (this manual) describes all functions of the model series including the machine. Some of the functions listed in User's Guide may not be available depending on your model. Use the table below to see which functions and options are supported by your model.

- 🔴 **Supported Functions(P. 3)**
- 🔴 **Supported Options(P. 4)**

## Supported Functions

✓ : Supported    — : Not supported

Function	MF275dw	MF272dw
Print	✓	✓
Scan	✓	✓
Fax	✓	—
Copy	✓	✓
2-sided Printing	✓	✓
Wired LAN connection	✓	✓
Wireless LAN connection	✓	✓
USB connection	✓	✓
Remote UI	✓	✓
Keys and certificates	✓	✓
Linking with mobile devices	✓	✓
Display	Touch panel	5 lines LCD
Feeder/Platen glass cover	Feeder (1-sided scanning)	Platen glass cover
Default System Manager ID	Not specified	Not specified
Default System Manager PIN	Not specified	Not specified
Toner Replenishment Service	✓	✓

## NOTE

- For details about the types of available drivers, see the Canon website for your country or region, or see the supplied User Software CD-ROM/DVD-ROM.  
**<https://global.canon/en/support/>**

## Supported Options

You can use various options to suit your purpose.

- Using the telephone and manually sending and receiving faxes **▶ TELEPHONE 6 KIT(P. 5)**

✓ : Supported    — : Not supported

Option	MF275dw	MF272dw
TELEPHONE 6 KIT	✓	—

## TELEPHONE 6 KIT

---

94WS-003

When using a voice telephone with the machine\*<sup>1</sup>, install the optional TELEPHONE 6 KIT.  
You can also use the handset to manually send and receive faxes.  
For about installing TELEPHONE 6 KIT, see "Setup Guide."  **Manuals of the Machine(P. 584)**

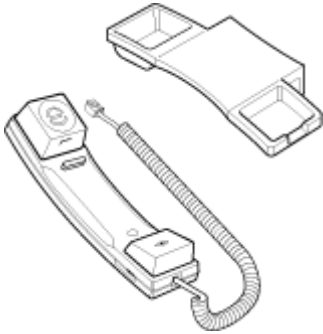

\*<sup>1</sup> You must connect the machine to a telephone line.

## System Manager ID and PIN

---

94WS-004

The machine has a System Manager Mode for viewing and changing important settings. When System Manager ID and System Manager PIN are set, only those users who know this information are able to log into System Manager Mode.

By default, the System Manager ID and System Manager PIN are not set. System Manager Mode is disabled, allowing anyone to see and change important settings. Set the System Manager ID and System Manager PIN to protect the information, and allow only certain administrators of this information.

For details about how to change and set the System Manager ID and System Manager PIN, see the following:

➤ **Setting the Department ID and PIN for the Administrator(P. 301)**

# Measures to Prevent Unauthorized Access

94WS-005

Be sure to read this section before using the machine in a network environment.

Printers and multifunction machines can provide various useful functions when connected to a network. However, because this also creates risks of unauthorized access and eavesdropping over the network, measures against security risks are essential.

This section provides examples of measures against unauthorized access that you can implement during setup when using the machine in a network environment.

- ▶ **Using a Private IP Address(P. 7)**
- ▶ **Using a PIN to Protect Information(P. 7)**
- ▶ **Precautions When Using Remote UI(P. 8)**

## NOTE

- There are additional measures against security risks you can implement on the machine, such as restricting communication with a firewall and using TLS encrypted communication to prevent eavesdropping and tampering. Take the necessary measures according to your usage environment. ▶ **Security(P. 300)**

## Using a Private IP Address

There are two types of IP addresses: a global IP address, which is used for connecting to the Internet, and a private IP address, which is used in a local area network such as a company LAN.

If a global IP address is assigned to the machine, the machine can be accessed by users on the Internet. Thus, the risk of information leakage due to unauthorized access from external network increases.

On the other hand, if a private IP address is assigned to the machine, access to the machine is restricted to only users on your local area network. Therefore, it reduces the risk of unauthorized access compared to an assigned global IP address.

Basically, assign a private IP address to the machine.

A private IP address is used in one of the following ranges.

### Ranges for Private IP Addresses

- From 10.0.0.0 to 10.255.255.255
- From 172.16.0.0 to 172.31.255.255
- From 192.168.0.0 to 192.168.255.255

For details about how to assign and confirm the IP address, see the following:

- ▶ **Setting IPv4 Addresses(P. 70)**
- ▶ **Setting IPv6 Addresses(P. 74)**

If you want to assign a global IP address to the machine, you can create an environment to prevent outside access, such as by using a firewall, to reduce the risk of unauthorized access. Contact your network administrator about how to implement network security.

## Using a PIN to Protect Information

By setting up a PIN to protect the information stored in the machine, you can reduce the risk of information leakage or unauthorized use if a malicious third party attempts to gain unauthorized access.

You can set a PIN to the functions indicated below. Only users who know the PIN can use these functions and access the information on the machine.

### Remote UI



You can require the user to enter the Remote UI Access PIN when using Remote UI.

▶ **Setting the PIN to Use for Remote UI(P. 337)**

**System Manager ID**

You can require the user to enter the System Manager ID and System Manager PIN, when changing any important settings.

▶ **Setting the Department ID and PIN for the Administrator(P. 301)**

**Address Book**

You can require the user to enter the Address Book PIN when adding new entries and editing existing ones.

▶ **Restricting Address Book Registration and Editing by Setting a PIN(P. 335)**

## Precautions When Using Remote UI

- Do not access other websites when using Remote UI.
- After using Remote UI, be sure to log out and close your browser.

## Names of Parts and Their Functions

---

94WS-006

### Front Side

Check these parts on the front when operating the machine.

#### ▶ Front Side(P. 10)

- Use the operation panel to operate the machine and configure the settings.
  - ▶ Operation Panel(P. 14)
- Place the original on the platen glass or in the feeder when scanning, sending a fax, or copying.
  - ▶ Feeder(P. 17)
- Load printing and copying paper into the paper drawer.
  - ▶ Paper Drawer(P. 18)

### Rear Side

Check the rear parts when installing and connecting the machine and when clearing paper jams.

#### ▶ Rear Side(P. 12)

### Interior

Check the interior of the machine when replacing toner cartridge.

#### ▶ Interior(P. 13)

## Front Side

94WS-007

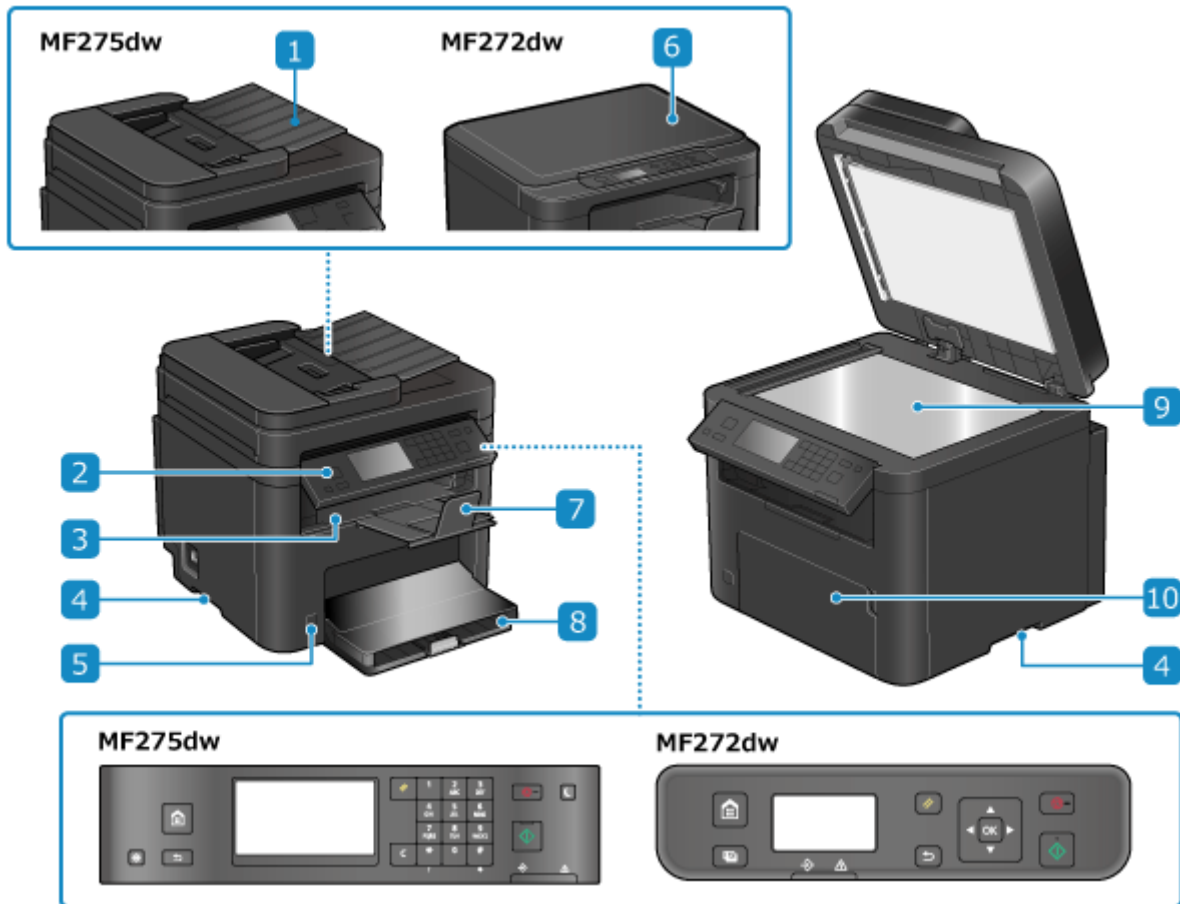

### 1 Feeder

You can place two or more sheets of originals in the feeder. The placed originals are fed and scanned one by one automatically. ▶ **Feeder(P. 17)**

### 2 Operation panel

Use the display and keys to operate the machine and confirm the operations and status. ▶ **Operation Panel(P. 14)**

### 3 Output tray

Printed and copied paper is ejected to the output tray.

### 4 Lift handles

Hold the lift handles when moving the machine.

### 5 Power switch

Turns the power of the machine ON and OFF. ▶ **Turning ON and OFF the Machine(P. 102)**

## 6 Platen glass cover

Protect the platen glass.

## 7 Paper stopper

Open the paper stopper to prevent paper from falling out of the output tray.

## 8 Paper drawer

Load paper you usually use into the paper drawer. ▶ **Paper Drawer(P. 18)**

## 9 Platen glass

Place books, thick paper, thin paper, and other originals that cannot be placed in the feeder on the platen glass to copy or scan. The placed originals are scanned in a fixed position. ▶ **Placing Originals(P. 129)**

## 10 Front cover

Open the front cover when loading paper into the paper drawer.

## NOTE

- To ensure efficient use of the machine, regularly clean the surface and platen glass.
  - ▶ **Cleaning the Surface of the Machine(P. 464)**
  - ▶ **Cleaning the Platen Glass(P. 465)**
- If the following symptoms occur when using the feeder, clean the feeder: ▶ **Cleaning the Feeder(P. 466)**
  - Originals become dirty
  - Originals frequently jam
  - Printouts appear smudged after scanning, copying, or sending faxes

## Rear Side

94WS-008

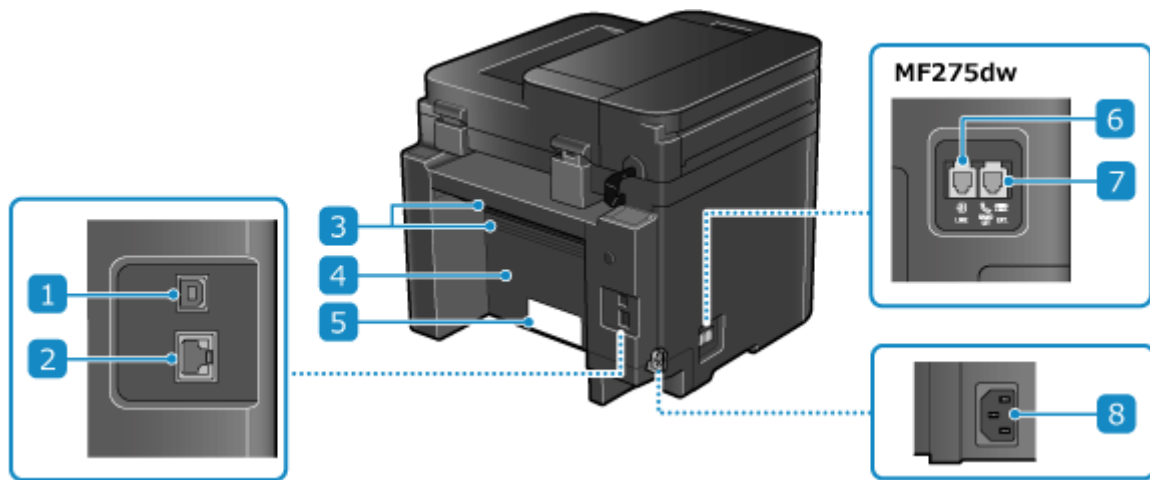

### 1 USB port (for computer connection)

You can connect a computer to the USB port using a commercial USB cable.

### 2 LAN port

You can connect the machine to a wired LAN using a commercial Ethernet cable connected to the LAN port.

### 3 Ventilation slots

Air inside the machine is released through the ventilation slots to cool down the inside of the machine. Do not place objects next to the ventilation slots, as this can prevent ventilation.

### 4 Rear cover

Open the rear cover when a paper jam occurs inside the machine.

### 5 Rating label

This label shows the serial number, which is needed when making inquiries about the machine.

### 6 Telephone line jack (LINE)

Use the supplied telephone cord to connect the machine to the telephone line.

### 7 Handset jack (HAND SET)/External telephone jack (EXT.)

Connect the optional TELEPHONE 6 KIT or a commercial telephone to this jack.

### 8 Power socket

Connect the power cord to the power socket.

## Interior

94WS-009

Install the toner cartridge into the machine. ▶ **Replacing the Toner Cartridge(P. 471)**

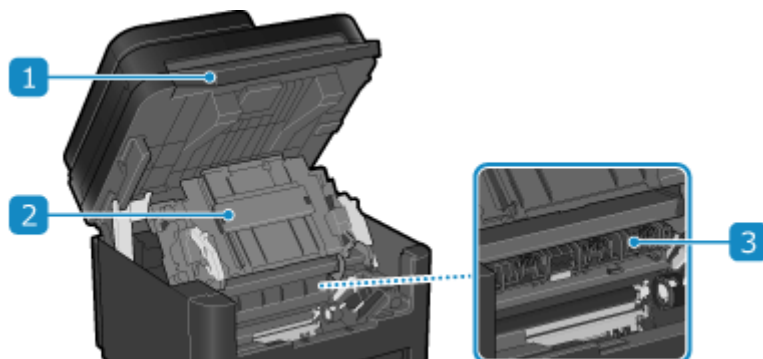

### 1 Operation panel

Lift up the operation panel when replacing the toner cartridge and clearing paper jams.

- ▶ **Replacing Toner Cartridge(P. 474)**
- ▶ **Paper Jams in the Paper Drawer, Output Tray, and Rear Side(P. 489)**

### 2 Toner cover

Open the toner cover when replacing the toner cartridge and clearing paper jams.

- ▶ **Replacing Toner Cartridge(P. 474)**
- ▶ **Paper Jams in the Paper Drawer, Output Tray, and Rear Side(P. 489)**

### 3 Paper exit guides

Open the paper exit guides to clear paper jams. ▶ **Paper Jams in the Paper Drawer, Output Tray, and Rear Side(P. 489)**

# Operation Panel

94WS-00A

Use the operation panel to operate the machine and configure the settings.



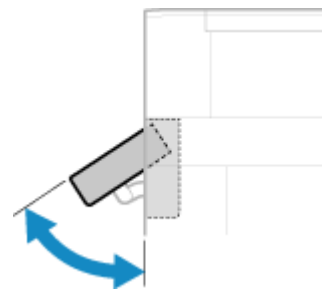



If the display is difficult to see, adjust the angle of the operation panel, as shown on the right. (Touch Panel Model)

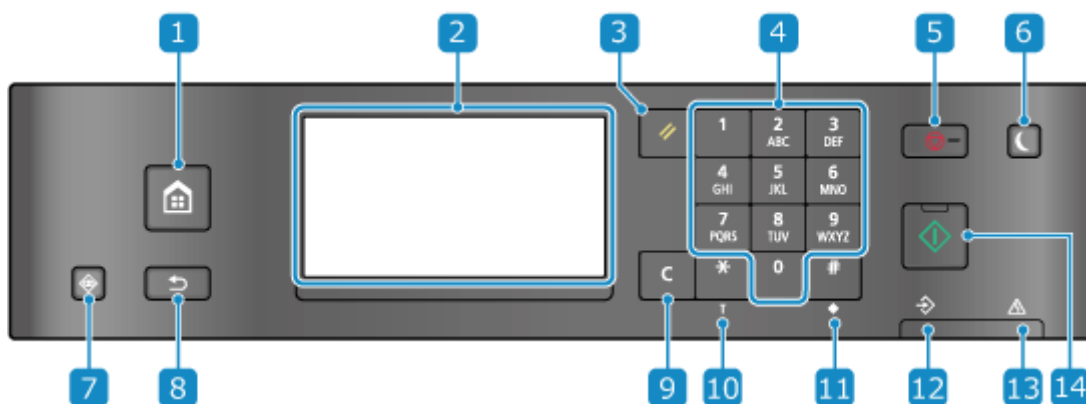

- ▶ **Operation Panel of Touch Panel Model(P. 14)**
- ▶ **Operation Panel of 5 Lines LCD Model(P. 15)**

## Operation Panel of Touch Panel Model



- 1 Home key (  )**  
 Displays the [Home] screen. ▶ **[Home] Screen(P. 113)**
  
- 2 Display**  
 Displays the screens for operating the functions, usage, messages, and other information. This touch panel can be operated by directly touching the screen with your finger. ▶ **Using the Operation Panel(P. 109)**
  
- 3 Reset Key (  )**  
 Clears the settings and returns the printer to its previous status.
  
- 4 Numeric keys (  to  )**  
 Enter numbers or characters. ▶ **Entering Characters Using the Operation Panel (Touch Panel Model) (P. 122)**
  
- 5 Stop key (  )**  
 Cancels printing and other operations.
  
- 6 Energy Saver key (  )**  
 Puts the machine into sleep mode to reduce power consumption. In sleep mode,  lights up yellow-green. ▶ **Reducing Power Consumption (Sleep Mode)(P. 107)**

**7 Status Monitor key (  )**

Check the information of the machine, usage and logs, network settings, and error information.  **[Status Monitor] Screen(P. 116)**

**8 Back key (  )**

Returns you to the previous screen.

**9 Clear key (  )**

Deletes the entered numbers and text.

**10 Uppercase/lowercase/numeric/tone key (  )**

Changes the character type or sends a tone signal via the pulse dialing line.

**11 Symbol key (  )**

Enter symbols.  **Entering Characters Using the Operation Panel (Touch Panel Model)(P. 122)**

**12 Data indicator**

Blinks when an operation is being performed, such as during printing, and lights up when data is waiting to be processed.

**13 Error indicator**

Blinks or lights up when a paper jam or other error occurs.

**14 Start key (  )**

Press this to start scanning or copying.

Operation Panel of 5 Lines LCD Model

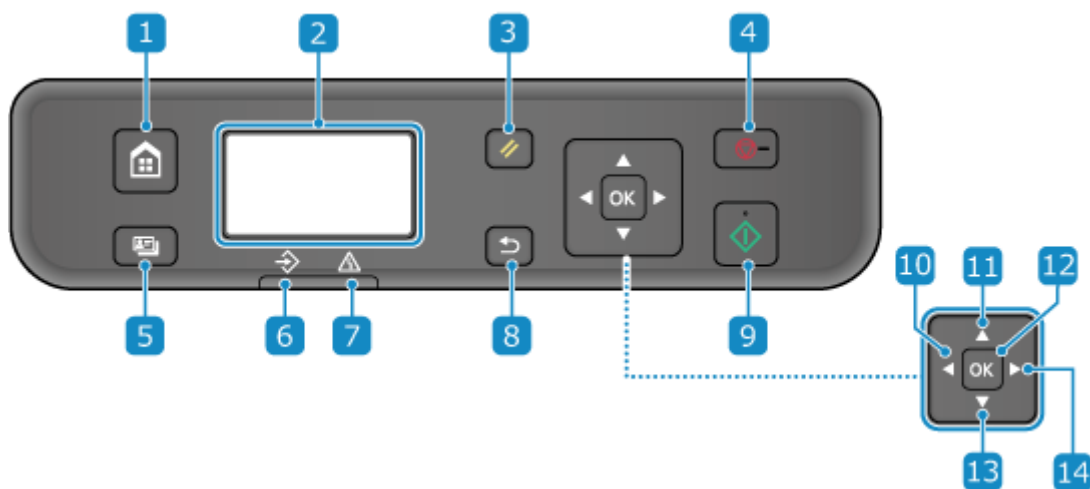

**1 Home key (  )**

Displays the [Home] screen.  **[Home] Screen(P. 113)**



## 2 Display

Displays the screens for operating the functions, usage, messages, and other information.  **Using the Operation Panel(P. 109)**

## 3 Reset key ( )

Clears the settings and returns the printer to its previous status.

## 4 Stop key ( )

Cancels printing and other operations.

## 5 ID Card Copy key ( )

You can use this to copy the front and back sides of a driver's license or other ID card on the same sheet of paper at 100% magnification.  **Copying Both Sides of ID Cards onto One Sheet(P. 260)**

## 6 Data indicator

Blinks when an operation is being performed, such as during printing, and lights up when data is waiting to be processed.

## 7 Error indicator

Blinks or lights up when a paper jam or other error occurs.

## 8 Back key ( )

Returns you to the previous screen.

## 9 Start key ( )

Press this to start scanning or copying.

## 10 Left key ( )

Returns to the previous screen. Press when entering text to move the cursor to the left.

## 11 Up key ( )

Selects the item above and increases the value on a slider.

## 12 OK key ( )

Confirms the settings and selected details.

## 13 Down key ( )

Selects the item below and decreases the value on a slider.

## 14 Right key ( )

Moves to the next screen. Press when entering text to move the cursor to the right.

## Feeder

94WS-00C

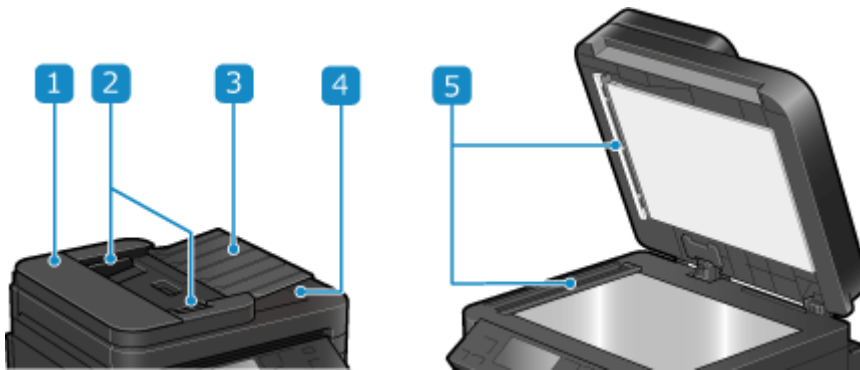

### 1 Feeder cover

Open the feeder cover when cleaning the inside of the feeder or clearing a paper jam inside the feeder.

### 2 Slide guides

Align the slide guides against the edges of the originals to properly place the original.

### 3 Original supply tray

You can place two or more sheets of originals in the original supply tray. ▶ **Placing Originals(P. 129)**

### 4 Original output tray

Scanned originals are output to the original output tray.

### 5 Document feed scanning area

Originals placed on the feeder are scanned.

## ! IMPORTANT

- Do not place objects on the original output tray. This can damage the originals.

## NOTE

- If the following symptoms occur when using the feeder, clean the feeder: ▶ **Cleaning the Feeder(P. 466)**
  - Originals become dirty
  - Originals frequently jam
  - Printouts appear smudged after scanning, copying, or sending faxes

## Paper Drawer

---

94WS-00F

Load paper that you usually use into the paper drawer. ▶ **Loading Paper in the Paper Drawer(P. 133)**

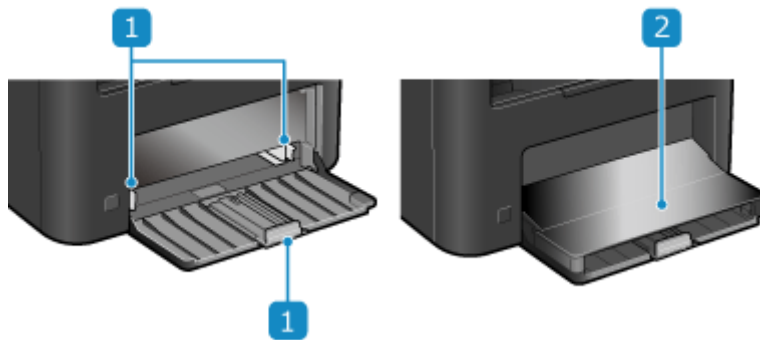

### **1 Paper guides**

Align the paper guides against the edges of the paper to properly place the paper.

### **2 Paper cover**

Open the paper cover when loading paper into the paper drawer.

# Usable Paper

The sizes and types of paper that can be used on the machine are shown below.

- ▶ Usable Paper Sizes(P. 19)
- ▶ Usable Paper Types(P. 20)
- ▶ Unusable Paper(P. 21)

## NOTE

- Precautions must be taken when handling and storing paper. ▶ Precautions When Handling Paper(P. 22)

## Usable Paper Sizes

✓ : Usable    ✕ : Not usable

Paper Size	Paper Drawer	Automatic 2-sided Printing <sup>*1</sup>
A4 <sup>*2*3</sup>	✓	✓
B5 <sup>*2</sup>	✓	✕
A5 <sup>*2 *4</sup>	✓	✕
A6	✓	✕
Legal (LGL) <sup>*2</sup>	✓	✓
Letter (LTR) <sup>*2*3</sup>	✓	✓
Statement (STMT) <sup>*2</sup>	✓	✕
Executive (EXEC)	✓	✕
Oficio <sup>*2</sup>	✓	✓
Oficio (Brazil) <sup>*2</sup>	✓	✓
Oficio (Mexico) <sup>*2</sup>	✓	✓
Letter (Government) <sup>*2</sup>	✓	✕
Legal (Government) <sup>*2</sup>	✓	✕

Paper Size	Paper Drawer	Automatic 2-sided Printing <sup>*1</sup>
Foolscap/Folio <sup>*2</sup>	✓	✓
Foolscap (Australia) <sup>*2</sup>	✓	×
Legal (India)	✓	✓
3x5inch	✓	×
Envelope No.10 (COM10)	✓	×
Envelope Monarch	✓	×
Envelope C5	✓	×
Envelope DL	✓	×
Custom Paper Size	✓ <sup>*5</sup>	✓ <sup>*6</sup>

<sup>\*1</sup> Automatically prints on both sides without having to reload the paper.

<sup>\*2</sup> Enables printing of received faxes.

<sup>\*3</sup> Enables printing of reports and lists.

<sup>\*4</sup> Enables loading of paper in the portrait or landscape orientation.

<sup>\*5</sup> You can use a custom size from 76.0 mm x 127.0 mm to 216.0 mm x 356.0 mm.

<sup>\*6</sup> You can use a custom size from 210.0 mm x 279.0 mm to 216.0 mm x 356.0 mm.

## Usable Paper Types

You can use non-chlorine paper.

✓ : Usable    × : Not usable

Paper Type	Paper Weight	Paper Drawer	Automatic 2-sided Printing <sup>*1</sup>
Thin 1 <sup>*2</sup>	60 g/m <sup>2</sup>	✓	✓
Plain 1 <sup>*2*3</sup>	61 g/m <sup>2</sup> to 70 g/m <sup>2</sup>	✓	✓
Plain 2 <sup>*2*3</sup>	71 g/m <sup>2</sup> to 89 g/m <sup>2</sup>	✓	✓
Plain 3 <sup>*2*3</sup>	90 g/m <sup>2</sup> to 105 g/m <sup>2</sup>	✓	✓
Heavy 1	106 g/m <sup>2</sup> to 120 g/m <sup>2</sup>	✓	×

Paper Type	Paper Weight	Paper Drawer	Automatic 2-sided Printing <sup>*1</sup>
Heavy 2	121 g/m <sup>2</sup> to 163 g/m <sup>2</sup>	✓	×
Recycled 1 <sup>*2*3</sup>	61 g/m <sup>2</sup> to 70 g/m <sup>2</sup>	✓	✓
Recycled 2 <sup>*2*3</sup>	71 g/m <sup>2</sup> to 89 g/m <sup>2</sup>	✓	✓
Labels	—	✓	×
Color <sup>*2*3</sup>	61 g/m <sup>2</sup> to 70 g/m <sup>2</sup>	✓	✓
Letterhead 1	61 g/m <sup>2</sup> to 70 g/m <sup>2</sup>	✓	✓
Letterhead 2	71 g/m <sup>2</sup> to 89 g/m <sup>2</sup>	✓	✓
Letterhead 3	90 g/m <sup>2</sup> to 105 g/m <sup>2</sup>	✓	✓
Letterhead 4	106 g/m <sup>2</sup> to 120 g/m <sup>2</sup>	✓	×
Letterhead 5	121 g/m <sup>2</sup> to 163 g/m <sup>2</sup>	✓	×
Bond 1	60 g/m <sup>2</sup> to 104 g/m <sup>2</sup>	✓	✓
Bond 2	105 g/m <sup>2</sup> to 163 g/m <sup>2</sup>	✓	×
Envelope	—	✓	×

<sup>\*1</sup> Automatically prints on both sides without having to reload the paper.

<sup>\*2</sup> Enables printing of received faxes.

<sup>\*3</sup> Enables printing of reports and lists.

## Unusable Paper

Before printing, check whether the paper to use is suitable. Do not use the following types of paper, as they can cause paper jams or printing errors:

- Wrinkled, creased, curled, torn, or damp paper<sup>\*1</sup>
- Thin straw paper, very thin paper, coarse paper, glossy paper
- Paper with glue or other adhesive sticking out or label paper whose back side can be easily peeled off
- Paper printed by a thermal transfer printer, back side of paper printed by a thermal transfer printer

<sup>\*1</sup> Printing on damp paper may cause steam to be emitted from the output area or water droplets to adhere to the output part, but this does not indicate a malfunction. This is because the water contained in the paper evaporates due to the heat generated when the toner fixes to the paper. This is more likely to occur when the room temperature is low.

## Precautions When Handling Paper

---

94WS-00J

To prevent paper jams and other errors and ensure beautiful printing, you must take precautions when handling and storing paper.

To maintain the quality of printed paper, pay attention when storing and gluing paper.

### ■ Handling and Storing Paper

#### **Acclimating the Paper to the Usage Environment**

Before using the paper in the machine, be sure to fully acclimate the paper to the environment where the machine is located. Immediately using paper stored in a location with a different temperature or humidity can cause paper jams or printing errors.

#### **Storing Paper Before Use**

- It is recommended that you use paper as soon as possible after opening the package. Any remaining paper should be wrapped in the original package and stored on a flat surface.
- To protect the paper from moisture or dryness, keep the paper wrapped in its package until use.
- Do not store the paper so that it curls or folds.
- Do not store the paper vertically, and do not stack too much paper.
- Do not store the paper in direct sunlight, or in a place with high humidity, dryness, or a drastically different temperature or humidity compared to the usage environment.

### ■ Storing and Gluing Printed Paper

#### **Storing Paper**

- Store the paper on a flat surface.
- Do not store the paper together with items made of polyvinyl chloride (PVC) such as a clear folder. The toner may melt, causing the paper to stick to the PVC material.
- Do not store the paper folded or creased. Toner may peel off.
- Do not store the paper in a place with high temperature.
- When storing the paper for a long period of time (two years or longer), store in a binder or similar item.
- Storing the paper for a long period of time can cause a discoloration of the paper, resulting in a discoloration of printed images.

#### **Precautions When Gluing Printed Paper**

- Always use insoluble adhesives.
- Before applying adhesive, perform a test using an unneeded printout.
- Allow glued paper to fully dry before stacking.

# Specifications

---

94WS-00K

Specifications are subject to change for product improvement, and the contents may be updated depending on products released in the future. For details about product information, see the Canon website.  
<https://global.canon/>

## Specifications of Main Unit

- ▶ **Basic Specifications(P. 24)**
- ▶ **Feeder Specifications(P. 27)**

## Specifications of Functions

- ▶ **Print Specifications(P. 28)**
- ▶ **Scan Specifications(P. 29)**
- ▶ **Fax Specifications(P. 30)**
- ▶ **Network Specifications(P. 31)**
- ▶ **Security and Management Function Specifications(P. 32)**

## Operating Environment and Supported Software and Servers

- ▶ **Supported Environment(P. 35)**

## ■ See Also

### Specifications of Options

You can check the compatibility of options and their specifications.

- ▶ **Supported Options(P. 4)**



# Basic Specifications

94WS-00L

<b>Type</b>	Desktop
<b>Color Supported</b>	Black and White
<b>Scan Resolution</b>	600 dpi x 600 dpi
<b>Print Resolution</b>	600 dpi x 400 dpi 600 dpi x 600 dpi (at 2/3 speed)
<b>Number of Tones</b>	256
<b>Copy Original</b>	Maximum: 216.0 mm x 297.0 mm Sheet/Book (Maximum height 40 mm, Maximum weight of the original 2.0 kg)
<b>Copy Paper Size</b>	Maximum: 216.0 mm x 356.0 mm Minimum (paper drawer): 76.0 mm x 127.0 mm <b>Margin (when copying)</b> <b>Platen Glass</b> Top: 5.0 mm ± 2.0 mm Left and right: 5.0 mm ± 2.0 mm <b>Feeder</b> Top: 5.0 mm ± 2.0 mm Left and right: 5.0 mm ± 2.0 mm
<b>Paper Type and Weight</b>	▶ <b>Usable Paper(P. 19)</b>
<b>Warm-up time <sup>*1</sup></b>	<b>After powering ON</b> 9.0 seconds or less (until copy ready) <b>After recovering from sleep mode</b> 3.2 seconds or less
<b>First Copy Time (A4)</b>	Approx. 7.6 seconds
<b>Continuous Copy Speed <sup>*2</sup> (A4)</b>	29 sheets/minute
<b>Original Scanning Speed (A4)</b>	<b>Full Color</b> 3.5 seconds/sheet <b>Black and White</b>

About the Machine

	2.7 seconds/sheet
<b>Magnification</b>	25% to 400% (in 1% increments)
<b>Paper Feeding System and Paper Capacity</b> *3	<b>Paper Drawer x 1</b> 150 sheets (60 g/m <sup>2</sup> , 80 g/m <sup>2</sup> )
<b>Output System and Output Capacity</b> *3	<b>Output Tray</b> 100 sheets (75 g/m <sup>2</sup> )
<b>Number of Continuous Copies</b>	999 sheets
<b>Power supply</b>	AC 220 V - 240 V, 50 Hz/60 Hz, 2.7 A
<b>Power Consumption</b> *1	<b>Maximum Power Consumption</b> 1,300 W or less  <b>During Sleep Mode</b> Approx. average of 1.0 W (USB, wired LAN, or wireless LAN connection)  <b>With Power Turned OFF</b> 0.3 W or less
<b>Dimensions</b> (W x D x H)	<b>MF275dw</b> 390 mm x 374 mm x 368 mm  <b>MF272dw</b> 372 mm x 320 mm x 271 mm
<b>Weight</b> (Not including toner cartridges)	<b>MF275dw</b> Approx. 11.5 kg  <b>MF272dw</b> Approx. 8.5 kg
<b>Maximum Occupancy Space</b>	<b>MF275dw</b> 429 mm x 614 mm x 638 mm (without optional handset) 474 mm x 614 mm x 638 mm (with optional handset)  <b>MF272dw</b> 372 mm x 598 mm x 526 mm  * Provide a space of at least 100 mm around the machine.
<b>Memory Capacity</b>	RAM: 256 MB
<b>Usage Environment</b>	Temperature: 10 °C to 30 °C

## About the Machine

	Humidity: 20% to 80% RH (no condensation)
--	---

\*1 May vary depending the usage environment and usage conditions.

\*2 Copy/print speeds are measured based on internal testing using A4 size paper copied/printed with 100% copy/print ratio to original on one-sided paper. Internal testing involved continuously copying/printing the same one page of content on plain paper (copy speed is tested by copying on the platen glass). Copy/print speeds may vary depending on paper type, paper size or paper feeding direction.  
The device may automatically pause or slow down in order to adjust printer condition such as controlling temperature of a certain unit or limiting impact to image quality during continuous copying/printing.

\*3 May vary depending on the installation environment and paper to be used.

## Feeder Specifications

94WS-00R

<b>Feeder Type</b>	<b>MF275dw</b> Automatic Document Feeder
<b>Original Size and Type</b>	<b>Original Size</b> Maximum: 216.0 mm x 356.0 mm Minimum: 148.0 mm x 105.0 mm <b>Original Weight</b> 50 g/m <sup>2</sup> to 105 g/m <sup>2</sup>
<b>Original Storage Capacity (A4)</b>	35 sheets (80 g/m <sup>2</sup> )
<b>Original Scanning Speed (A4)</b>	<b>Copying (300 dpi x 600 dpi)</b> <b>1-sided Scanning</b> Full color: 7 pages/minute Black and White: 20 pages/minute <b>Copying (300 dpi x 300 dpi) *1</b> <b>1-sided Scanning</b> Full color: 15 pages/minute Black and White: 20 pages/minute

\*1 May vary depending the usage environment and usage conditions.

# Print Specifications

94WS-00S





## ▶ UFR II Printer Function(P. 28)

### UFR II Printer Function

<b>Type</b>	Internal
<b>Print Size</b>	▶ <b>Usable Paper(P. 19)</b>
<b>Continuous Print Speed</b>	Same as "Continuous Copy Speed" for main unit ▶ <b>Basic Specifications(P. 24)</b>
<b>Resolution</b>	<b>Data Processing</b>  600 dpi x 600 dpi
<b>Page Description Language (PDL)</b>	UFR II
<b>Protocol Supported</b>	TCP/IP: LPD, Port9100, IPP, IPPS, WSD
<b>Resident Fonts</b>	None
<b>Interface</b>	<b>USB</b>  USB 2.0 Hi-Speed <b>Wired LAN</b>  10Base-T, 100Base-TX (IEEE 802.3 compliant) <b>Wireless LAN</b>  IEEE 802.11b, IEEE 802.11g, IEEE 802.11n

# Scan Specifications

94WS-00U

<b>Type</b>	Color Scanner
<b>Original Scan Size</b>	<p><b>Platen Glass</b></p> <p>Same as "Copy Original" for main unit   <b>Basic Specifications(P. 24)</b></p> <p><b>Feeder</b></p> <p>Same as "Original Size and Type" for feeder   <b>Feeder Specifications(P. 27)</b></p>
<b>Resolution (Maximum)</b>	300 dpi x 600 dpi
<b>Original Scanning Speed</b>	<p><b>Platen Glass</b></p> <p>Same as "Original Scanning Speed" for main unit   <b>Basic Specifications(P. 24)</b></p> <p><b>Feeder</b></p> <p>Same as "Original Scanning Speed" for feeder   <b>Feeder Specifications(P. 27)</b></p>
<b>Interface</b>	<p><b>USB</b></p> <p>USB 2.0 Hi-Speed</p> <p><b>Wired LAN</b></p> <p>10BASE-T, 100BASE-TX (RJ-45)</p> <p><b>Wireless LAN</b></p> <p>IEEE 802.11b, IEEE 802.11g, IEEE 802.11n</p>
<b>Protocol Supported</b> *1	TCP/IP, USB
<b>Output Format</b>	JPEG (Single Page)

\*1 Some formats are not available depending on the function.

# Fax Specifications

94WS-00W

<b>Line Used</b> *1	Public Switched Telephone Network (PSTN), Facsimile Communication Network (PSTN)
<b>Scan Line Density</b>	<p><b>Normal Mode</b></p> <p>G3: 8 pels/mm<sup>*2</sup> x 3.85 line/mm</p> <p><b>Fine Mode</b></p> <p>G3: 8 pels/mm<sup>*2</sup> x 7.7 line/mm</p> <p><b>Superfine Mode</b></p> <p>G3: 8 pels/mm<sup>*2</sup> x 15.4 line/mm</p>
<b>Transmission Speed</b> *3	<p>SuperG3: 33.6 Kbps</p> <p>G3: 14.4 Kbps</p>
<b>Compression Method</b>	MH, MR, MMR, JBIG
<b>Communication Mode</b>	SuperG3, G3
<b>Maximum Sending Original Size</b>	A4
<b>Recording Paper Size</b>	🔴 <b>Usable Paper(P. 19)</b>
<b>Transmission Time</b>	Approx. 2.6 seconds*4

\*1 Depending on your telephone line and region, you may not be able to perform data communication, such as when the sum of the resistance value of the telephone line and that of the machine exceeds 1,700 Ω. In this case, contact your dealer or service representative.

\*2 Pels stands for picture elements (pixels).

\*3 With Automatic Fallback function.

\*4 Value obtained with Canon original test sheet of A4 size, standard ECM (JBIG) transmission.

# Network Specifications

94WS-00X

## ■ Common

<b>Protocol Supported</b>	TCP/IP  Frame type: Ethernet II Print applications: LPD, Raw, IPP, IPPS, WSD, Mopria, AirPrint, Windows10 Mobile Print, Windows11 Mobile Print
---------------------------	---

## ■ Wired LAN

<b>Interface</b>	10BASE-T, 100BASE-TX (RJ-45)
------------------	------------------------------

## ■ Wireless LAN

<b>Standard</b>	IEEE 802.11b, IEEE 802.11g, IEEE 802.11n
<b>Transmission Method</b>	IEEE 802.11b (Modulation system: DS-SS) IEEE 802.11g (Modulation system: OFDM method) IEEE 802.11n (Modulation system: OFDM method)
<b>Communication Mode</b>	Infrastructure Mode Access Point Mode
<b>Security</b> (Encryption Method)	<b>Infrastructure Mode</b> 128 (104) / 64 (40) bit WEP WPA-PSK (TKIP / AES-CCMP) WPA2-PSK (TKIP / AES-CCMP) WPA-EAP (AES-CCMP) WPA2-EAP (AES-CCMP) <b>Access Point Mode</b> WPA2-PSK (AES-CCMP)
<b>Setup Method</b>	WPS (Wi-Fi Protected Setup), Manual setup



# Security and Management Function Specifications

94WS-00Y

- ▶ Firewall(P. 32)
- ▶ Keys and Certificates(P. 32)
- ▶ Definition of "Weak Encryption"(P. 33)
- ▶ TLS(P. 33)

## Firewall

- Up to 16 IP addresses (or ranges of IP addresses) can be specified for both IPv4 and IPv6.
- Up to 32 MAC addresses can be specified.

## Keys and Certificates

The following keys and certificates are supported:

### ■ Self-generated Key and Self-signed Certificate or CSR

<b>Public key algorithm (and key length)</b>	RSA (512 bits, 1024 bits, 2048 bits, 4096 bits) ECDSA (P256, P384, P521)
<b>Certificate signature algorithm</b>	RSA: SHA-256, SHA-384* <sup>1</sup> , SHA-512* <sup>1</sup> ECDSA: SHA-256, SHA-384, SHA-512

\*<sup>1</sup> SHA384-RSA and SHA512-RSA are available only when the RSA key length is 1024 bits or more.

### ■ Key and Certificate or CA Certificate for Installation

<b>Format</b>	<b>Key</b> PKCS#12* <sup>1</sup> <b>CA certificate</b> X.509 DER format/PEM format
<b>File extension</b>	<b>Key</b> ".p12" or ".pfx" <b>CA certificate</b> ".cer" or ".pem"
<b>Public key algorithm (and key length)</b>	RSA (512 bits, 1024 bits, 2048 bits, 4096 bits) ECDSA (P256, P384, P521)

<b>Certificate signature algorithm</b>	RSA: SHA-256, SHA-384* <sup>2</sup> , SHA-512* <sup>2</sup> ECDSA: SHA-256, SHA-384, SHA-512
--	---

\*1 Requirements for the certificate contained in a key are pursuant to CA certificates.

\*2 SHA384-RSA and SHA512-RSA are available only when the RSA key length is 1024 bits or more.

## NOTE

- The machine does not support use of a certificate revocation list (CRL).

## Definition of "Weak Encryption"

When [Prohibit Use of Weak Encryption] in [Encryption Settings] is set to [On], the use of the following algorithms is prohibited. [▶\[Encryption Settings\]\(P. 458\)](#)

<b>Hash</b>	MD4, MD5, SHA-1
<b>HMAC</b>	HMAC-MD5
<b>Common key encryption</b>	RC2, RC4, DES
<b>Public key encryption</b>	RSA encryption (512 bits/1024 bits) RSA signature (512 bits/1024 bits) DSA (512 bits/1024 bits) DH (512 bits/1024 bits)

## NOTE

- Even when [Prohibit Key/Cert. with Weak Encryption] in [Encryption Settings] is set to [On], the hash algorithm SHA-1, which is used for signing a root certificate, can be used.

## TLS

The following combinations of the TLS version and algorithm are usable:

✓ : Usable    — : Not usable

Algorithm	TLS Version			
	TLS 1.3	TLS 1.2	TLS 1.1	TLS 1.0
<b>Encryption Algorithm</b>				
AES-CBC (256bit)	—	✓	✓	✓

Algorithm	TLS Version			
	TLS 1.3	TLS 1.2	TLS 1.1	TLS 1.0
AES-CBC (128bit)	—	✓	✓	✓
AES-GCM (256bit)	✓	✓	—	—
AES-GCM (128bit)	✓	✓	—	—
3DES-CBC	—	✓	✓	✓
CHACHA20-POLY1305	✓	—	—	—
<b>Key Exchange Algorithm</b>				
RSA	—	✓	✓	✓
ECDHE	✓	✓	✓	✓
X25519	✓	—	—	—
<b>Signature Algorithm</b>				
RSA	✓	✓	✓	✓
ECDSA	✓	✓	✓	✓
<b>HMAC Algorithm</b>				
SHA1	—	✓	✓	✓
SHA256	✓	✓	—	—
SHA384	✓	✓	—	—

# Supported Environment

94WS-010

## Operating Environment(P. 35)

### Operating Environment

<b>System Environment for WSD Scan</b>	Windows 8.1 Windows 10 Windows 11
<b>AirPrint Operating Environment</b>	▶ <b>Using AirPrint Application to Print and Scan Data and Send Faxes(P. 293)</b>
<b>Remote UI Operating Environment *1</b>	<p><b>Windows</b></p> <p>Internet Explorer 11</p> <p>Microsoft Edge</p> <p>Google Chrome</p> <p><b>macOS</b></p> <p>Safari 11</p> <p>Google Chrome</p> <p><b>Android</b></p> <p>Google Chrome</p> <p>UC Browser</p> <p><b>iOS</b></p> <p>Safari 11</p> <p>UC Browser</p>

\*1 You must set your Web browser to enable cookies and use JavaScript.

## Recommended Functions

---

94WS-011

This section introduces recommended functions that can be useful for your purpose and help you solve problems, such as to simplify document management and sharing, save paper and power, and improve operations.

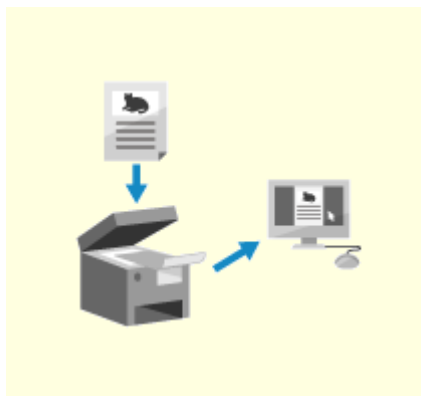

▶ **Digitizing Documents(P. 37)**

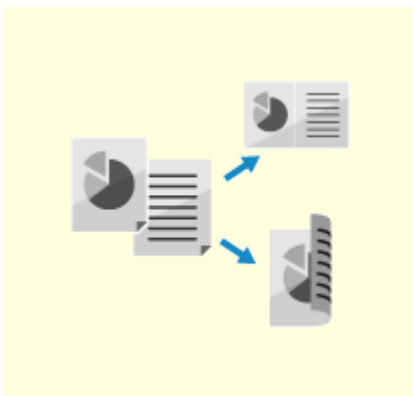

▶ **Cost Savings(P. 38)**



▶ **Making Operations More Efficient(P. 39)**

# Digitizing Documents

94WS-012

By digitizing paper documents, you do not have to worry about storage space and documents deteriorating, and you can view and use these documents on a computer or mobile device.

## Scanning Paper Documents

You can use the scan function to scan documents and photos into data that can be saved.

▶ **Scanning(P. 193)**



## Digitizing Fax Documents

You can digitize received faxes and send faxes directly from a computer. You can also send and view faxes in a timely fashion even if you are away from the machine.

### Forwarding and Saving Received Faxes as Data

Received faxes can be automatically forwarded to a specified computer or mobile device and saved.

▶ **Auto Forwarding and Backing Up Received Faxes(P. 219)**



### Sending Faxes from a Computer

You can use a procedure similar to that for printing documents and photos to send faxes directly from a computer.

▶ **Sending Faxes from a Computer (PC Faxing)(P. 225)**

▶ **Using AirPrint Application to Print and Scan Data and Send Faxes(P. 293)**

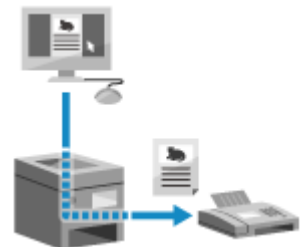

# Cost Savings

---

94WS-013

This machine can help you save costs on paper, power, and fax communication.

## Saving Paper

---

### Saving Paper When Printing

You can print on both sides of the paper, and print multiple pages on one sheet of paper.

- ▶ **Printing from a Computer(P. 182)**

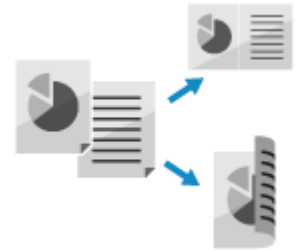

### Saving Paper When Faxing

Instead of immediately printing received faxes, you can temporarily save them in the memory of the machine and forward them automatically. You can view the faxes and print only those that are needed.

- ▶ **Saving Received Documents in the Machine (Memory Lock) (Touch Panel Model)(P. 331)**
- ▶ **Auto Forwarding and Backing Up Received Faxes(P. 219)**

You can print received faxes on both sides of the paper.

- ▶ **Changing the Print Settings for Received Faxes(P. 233)**

### Saving Paper When Copying

You can copy on both sides of the paper, and copy multiple originals or the front and back of a card on a sheet of paper.

- ▶ **Additional Copying Features (Touch Panel Model)(P. 244)**
- ▶ **Copying Both Sides of ID Cards onto One Sheet(P. 260)**

## Saving Energy

---

You can configure the machine to enter sleep mode when not in use to save energy. The power of the machine does not turn OFF, so it can quickly resume operations and receive faxes.

- ▶ **Reducing Power Consumption (Sleep Mode)(P. 107)**

# Making Operations More Efficient

94WS-014

You can print data even in an environment where a computer cannot be used. In addition, you can customize the operation panel to make operations more efficient and reduce the amount of time using the machine.

## Printing Data Without Using a Computer

### Printing Data from a Smartphone or Tablet

You can print data from a mobile device connected to the machine while using an application. The machine supports direct connection, allowing easy connection setup between the machine and a mobile device without having to use a wireless LAN router.

▶ **Linking with Mobile Devices and Integrating with a Cloud Service(P. 273)**



## Customizing operation panel for ease of use

### Using the Job Log to Send Faxes

You can send faxes to destinations specified in the past by calling up the TX Job Log for fax jobs. In addition to calling up the destination, you can also call up the past settings to save the trouble of having to configure the settings again.

▶ **Specifying Destinations (TX Job Log) (Touch Panel Model)(P. 163)**



### Customizing the Operation Panel for Greater Usability

In the scan function, you can register frequently used settings for faster and simpler scanning.

▶ **[Shortcut Key Settings](P. 433)**

In the copy function, you can change the standard default settings used when functions are called up.

▶ **Changing the Default Settings(P. 165)**



Through the toner replenishment service, new toner cartridges are automatically delivered to you before your existing toner cartridges are used up.

\* Use of the toner replenishment service requires prior registration with select retailers. This service is only available in certain countries.

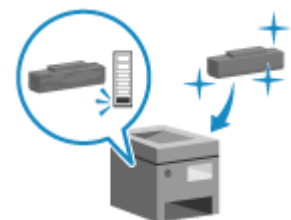



# Setting Up

<b>Setting Up</b> .....	41
<b>Configuring the Default Settings (Setup Guide) (Touch Panel Model)</b> .....	43
<b>Configuring the Default Settings (Setup Guide) (5 Lines LCD Model)</b> .....	46
<b>Setting Up the Network</b> .....	49
Selecting Wired or Wireless LAN .....	51
Connecting to a Wired LAN .....	53
Connecting to a Wireless LAN .....	54
Connecting to a Wireless LAN by Using the Router Button (Push Button Mode) .....	57
Connecting to a Wireless LAN by Entering a PIN Code (WPS PIN Code Mode) .....	59
Connecting to a Wireless LAN by Searching for a Router (Access Point Setup Method) .....	62
Connecting to a Wireless LAN by Setting the Details (Manual Setup Method) .....	65
Setting IPv4 Addresses .....	70
Setting IPv6 Addresses .....	74
Configuring Your Machine for Your Network Environment .....	76
Manually Configuring the Ethernet Settings .....	77
Configuring DNS .....	78
Configuring SMB .....	81
Configuring WINS .....	82
Configuring SNMP .....	83
Configuring Sntp .....	86
Checking the Network Status and Settings .....	88
<b>Configuring the Fax Settings (Fax Setup Guide) (Touch Panel Model)</b> .....	94
<b>Installing Software and Drivers to the Computer</b> .....	98

# Setting Up

94WS-015

After installing the machine, configure the required settings to enable use of the functions by performing the following steps.

▶ **Touch Panel Model(P. 41)**

▶ **5 Lines LCD Model(P. 42)**

## Touch Panel Model

Steps 1 to 3 are the machine settings.

Step 4 is the setting for using the machine from a computer. Configure this setting for each computer using the machine.

### Step 1

When you turn ON the machine for the first time, the screen (Setup Guide) for setting the items required for using the machine is displayed. Configure the settings by following the instructions on the screen.

▶ **Configuring the Default Settings (Setup Guide) (Touch Panel Model)(P. 43)**



### Step 2

Configure the network settings not included in the Setup Guide. If you did not connect to the network using the Setup Guide, do that during this step.

▶ **Setting Up the Network(P. 49)**



### Step 3

Set the items required to perform fax operations by following the instructions on the screen.

▶ **Configuring the Fax Settings (Fax Setup Guide) (Touch Panel Model)(P. 94)**



### Step 4

Install the software required to use the machine and any printer and fax drivers on your computer.

▶ **Installing Software and Drivers to the Computer(P. 98)**

## ■ See Also

### Implementing Measures to Prevent Unauthorized Access

It is important to provide measures against security risks when using the machine in a network environment. Check examples of measures that you can take with the machine.

▶ **Measures to Prevent Unauthorized Access(P. 7)**

### Checking Available Functions

The functions available on the machine vary depending on the model. Check the functions that are available on your model.

▶ **Supported Functions and Options(P. 3)**

### Configuring the Settings Required to Use the Functions of the Machine

Additional settings may be required depending on your model. For details about the settings required for each function, see the following:

▶ **Printing Preparations(P. 174)**

▶ **Preparations for Linking with Mobile Devices and Integrating with a Cloud Service(P. 274)**

## 5 Lines LCD Model

Steps 1 and 2 are the machine settings.

Step 3 is the setting for using the machine from a computer. Configure this setting for each computer using the machine.

### Step 1

When you turn ON the machine for the first time, the screen (Setup Guide) for setting the items required for using the machine is displayed. Configure the settings by following the instructions on the screen.

▶ **Configuring the Default Settings (Setup Guide) (5 Lines LCD Model)(P. 46)**



### Step 2

Configure the network settings not included in the Setup Guide. If you did not connect to the network using the Setup Guide, do that during this step.

▶ **Setting Up the Network(P. 49)**



### Step 3

Install the software required to use the machine and printer driver on your computer.

▶ **Installing Software and Drivers to the Computer(P. 98)**

## ■ See Also

### Implementing Measures to Prevent Unauthorized Access

It is important to provide measures against security risks when using the machine in a network environment. Check examples of measures that you can take with the machine.

▶ **Measures to Prevent Unauthorized Access(P. 7)**

### Checking Available Functions

The functions available on the machine vary depending on the model. Check the functions that are available on your model.

▶ **Supported Functions and Options(P. 3)**

### Configuring the Settings Required to Use the Functions of the Machine

Additional settings may be required depending on your model. For details about the settings required for each function, see the following:

▶ **Printing Preparations(P. 174)**

▶ **Preparations for Linking with Mobile Devices and Integrating with a Cloud Service(P. 274)**

# Configuring the Default Settings (Setup Guide) (Touch Panel Model)

94WS-016

When you turn ON the machine for the first time, the screen (Setup Guide) for setting the items required for using the machine is displayed. Configure the settings using the procedure below by following the instructions on the screen.

- ▶ **Step 1: Setting the Display Language and Country or Region(P. 43)**
- ▶ **Step 2: Setting the Date and Time(P. 43)**
- ▶ **Step 3: Setting Remote UI(P. 44)**
- ▶ **Step 4: Connecting to a Wireless LAN(P. 44)**
- ▶ **Step 5: Configuring Settings for Toner Replenishment Service(P. 45)**

## NOTE

- These settings can only be configured one time using the Setup Guide when starting the machine for the first time. To change the settings configured with the Setup Guide at a later time, set the items in Steps 2 to 5 individually. For the details of each setting, see the following.
  - ▶ **Setting the Date and Time(P. 347)**
  - ▶ **Setting the Department ID and PIN for the Administrator(P. 301)**
  - ▶ **Setting the PIN to Use for Remote UI(P. 337)**
  - ▶ **Connecting to a Wireless LAN(P. 54)**
  - ▶ **[Home] Screen(P. 113)**

## Step 1: Setting the Display Language and Country or Region

Set the language displayed on the operation panel screen and reports to be printed. Next, set the country or region where the machine is used.

### 1 On the [Language] screen, select the display language.

### 2 Press [Yes].

- ⇒ The display language is set, and the [Select Country/Region] screen is displayed. Depending on the country or region, the [Select Country/Region] screen is not displayed and the [Time Zone] screen is displayed. When the [Time Zone] screen is displayed, proceed to "Step 2: Setting the Date and Time." ▶ **Step 2: Setting the Date and Time(P. 43)**

### 3 On the [Select Country/Region] screen, select the country or region.

- ⇒ The country or region is set, and the [Time Zone] screen is displayed.

## Step 2: Setting the Date and Time

The date and time are used as the reference for the functions using date and time information, and therefore, they need to be set accurately.

## 1 On the [Time Zone] screen, select your time zone.

Set the time zone (UTC<sup>\*1</sup>) and Daylight Saving Time according to the region where this machine is installed.

\*1 The UTC (Coordinated Universal Time) is a coordinated universal time that is standard for all parts of the world. Internet-based communication relies on the UTC being set correctly.

## 2 On the [Current Time Set.] screen, enter the date and time, and press [Apply].

⇒ The time and date are set, and the Remote UI confirmation screen is displayed.

### Step 3: Setting Remote UI

With Remote UI, you can use a Web browser on a computer to check the operation status of the machine, change the settings, and perform other operations.

Set the System Manager ID and Remote UI Access PIN to prevent unauthorized access to the machine.

## 1 On the Remote UI confirmation screen, press [Yes].

## 2 Confirm the message, and press [Yes].

Restrict the use of Remote UI to only those users who know the Remote UI Access PIN.

## 3 Enter the Remote UI Access PIN, and press [Apply].

Specify any number. You cannot set a PIN consisting of all zeros, such as "00" or "0000000."

## 4 Enter the PIN again, and press [Apply].

⇒ After the message [Settings applied.] appears, and then the screen for confirming the wireless LAN connection is displayed.

### Step 4: Connecting to a Wireless LAN

Connect to the network using wireless local area network (LAN).

## 1 On the screen for confirming the wireless LAN connection, press [Yes].

- If the machine is not connected to a wireless LAN, press [No].
- When connecting to a wired LAN, configure the wired LAN connection settings after exiting the Setup Guide.
  - ◻ **Selecting Wired or Wireless LAN(P. 51)**

## 2 Select the Wireless LAN connection type, and connect to the Wireless LAN.

⇒ When the connection to the wireless LAN is completed, the Toner Replenishment Service confirmation screen is displayed.

Depending on your wireless LAN router, the connection type and security standards may vary. Check for a connection type and security standard that are supported by both the wireless LAN router and the machine,

and then establish a connection according to the connection type. For the standards and procedure, see the following:

▶ **Connecting to a Wireless LAN(P. 54)**

## Step 5: Configuring Settings for Toner Replenishment Service

You can configure settings for toner replenishment service. Through toner replenishment service, new toner cartridges are automatically delivered to you before your existing toner cartridges are used up.

\* Use of the toner replenishment service requires prior registration with select retailers. This service is only available in certain countries.

\* This service can be set up through [Toner Delivery Set.] displayed on the [Home] screen. ▶ **[Home] Screen(P. 113)**

**1 On the confirm screen of toner replenishment service, press [Next].**

**2 Press [Accept].**

If you press [Do Not Acpt.], the settings configured in the Setup Guide are applied.

When you exit the Setup Guide, the [Home] screen is displayed. ▶ **[Home] Screen(P. 113)**

**3 Press [Close].**

▶ The settings configured in the Setup Guide are applied.

When you exit the Setup Guide, the [Home] screen is displayed. ▶ **[Home] Screen(P. 113)**

- If connecting to the server fails, try configuring the settings again through [Connect to Server/Verify Connection] in [Toner Delivery Set.]. ▶ **[Home] Screen(P. 113)**

# Configuring the Default Settings (Setup Guide) (5 Lines LCD Model)

94WS-0J1

When you turn ON the machine for the first time, the screen (Setup Guide) for setting the items required for using the machine is displayed. Configure the settings using the procedure below by following the instructions on the screen.

- ▶ **Step 1: Setting the Display Language and Country or Region(P. 46)**
- ▶ **Step 2: Setting the Date and Time(P. 46)**
- ▶ **Step 3: Setting Remote UI(P. 47)**
- ▶ **Step 4: Connecting to a Wireless LAN(P. 47)**
- ▶ **Step 5: Configuring Settings for Toner Replenishment Service(P. 48)**

## NOTE

- These settings can only be configured one time using the Setup Guide when starting the machine for the first time. To change the settings configured with the Setup Guide at a later time, set the items in Steps 2 to 5 individually. For the details of each setting, see the following.
  - ▶ **Setting the Date and Time(P. 347)**
  - ▶ **Setting the Department ID and PIN for the Administrator(P. 301)**
  - ▶ **Setting the PIN to Use for Remote UI(P. 337)**
  - ▶ **Connecting to a Wireless LAN(P. 54)**

## Step 1: Setting the Display Language and Country or Region

Set the language displayed on the operation panel screen and reports to be printed. Next, set the country or region where the machine is used.

**1 On the [Language] screen, select the display language and press .**

**2 Select [Yes], and then press .**

- ⇒ The display language is set, and the [Select Country/Region] screen is displayed. Depending on the country or region, the [Select Country/Region] screen is not displayed and the [Time Zone] screen is displayed. When the [Time Zone] screen is displayed, proceed to "Step 2: Setting the Date and Time." ▶ **Step 2: Setting the Date and Time(P. 46)**

**3 On the [Select Country/Region] screen, select the country or region, and press .**

- ⇒ The country or region is set, and the [Time Zone] screen is displayed.

## Step 2: Setting the Date and Time

The date and time are used as the reference for the functions using date and time information, and therefore, they need to be set accurately.

**1 On the [Time Zone] screen, select your time zone and press .**

Set the time zone (UTC\*<sup>1</sup>) and Daylight Saving Time according to the region where this machine is installed.

\*<sup>1</sup> The UTC (Coordinated Universal Time) is a coordinated universal time that is standard for all parts of the world. Internet-based communication relies on the UTC being set correctly.

## 2 On the [Current Time Set.] screen, enter the date and time, and press **OK**.

⇒ The time and date are set, and the Remote UI confirmation screen is displayed.

## Step 3: Setting Remote UI

With Remote UI, you can use a Web browser on a computer to check the operation status of the machine, change the settings, and perform other operations.

Set the System Manager ID and Remote UI Access PIN to prevent unauthorized access to the machine.

### 1 On the Remote UI confirmation screen, select [<Yes>] and press **OK**.

To set the Remote UI Access PIN at a later time, select [<No>] and proceed to "Step 4: Connecting to a Wireless LAN." ▶ **Step 4: Connecting to a Wireless LAN(P. 47)**

### 2 Confirm the message ▶ press **OK** ▶ confirm the message ▶ select [Yes] ▶ press **OK**.

⇒ The [Remote UI Access PIN] screen is displayed.

Restrict the use of Remote UI to only those users who know the Remote UI Access PIN.

### 3 Enter the Remote UI Access PIN ▶ select [<Apply>] ▶ press **OK**.

Specify any number. You cannot set a PIN consisting of all zeros, such as "00" or "0000000."

### 4 Enter the PIN again ▶ select [<Apply>] ▶ press **OK**.

⇒ After the message [Settings applied.] appears, the screen for confirming the wireless LAN connection is displayed.

## Step 4: Connecting to a Wireless LAN

Connect to the network using wireless local area network (LAN).

### 1 On the screen for confirming the wireless LAN connection, select [Yes] and press **OK**.

- If the machine is not connected to a wireless LAN, select [No] and press **OK** and proceed to "Step 5: Configuring Settings for Toner Replenishment Service." ▶ **Step 5: Configuring Settings for Toner Replenishment Service(P. 48)**
- When connecting to a wired LAN, configure the wired LAN connection settings after exiting the Setup Guide. ▶ **Selecting Wired or Wireless LAN(P. 51)**

### 2 Select the Wireless LAN connection type, and connect to the Wireless LAN.

⇒ When the connection to the wireless LAN is completed, the Toner Replenishment Service confirmation screen is displayed.



Depending on your wireless LAN router, the connection type and security standards may vary. Check for a connection type and security standard that are supported by both the wireless LAN router and the machine, and then establish a connection according to the connection type. For the standards and procedure, see the following:

▶ **Connecting to a Wireless LAN(P. 54)**

## Step 5: Configuring Settings for Toner Replenishment Service

You can configure settings for toner replenishment service. Through toner replenishment service, new toner cartridges are automatically delivered to you before your existing toner cartridges are used up.

\* Use of the toner replenishment service requires prior registration with select retailers. This service is only available in certain countries.

\* This service can be set up through [Toner Delivery Set.] displayed on the [Home] screen. ▶ **[Home] Screen(P. 113)**

**1** On the confirm screen of toner replenishment service, press **OK**.

**2** Press **OK**.

**3** Press **OK**.

⇒ The settings configured in the Setup Guide are applied.

When you exit the Setup Guide, the [Home] screen is displayed. ▶ **[Home] Screen(P. 113)**

- If connecting to the server fails, try configuring the settings again through [Connect to Server/Verify Connection] in [Toner Delivery Set.]. ▶ **[Home] Screen(P. 113)**

# Setting Up the Network

94WS-017

To operate the machine from a computer or to connect to a server, you must connect the machine to a network. Use the procedure below to connect the machine to a network and configure the settings of the machine according to the network environment.

Administrator privileges are required to set up the network.

## IMPORTANT

- Connecting the machine to a network without proper security measures may leak information from the machine to third parties. [▶Protecting the Network\(P. 303\)](#)

### ■ Preparing to Set Up the Network

- Provide an Ethernet cable and router according to the usage environment of the machine.
- Check the information of the network environment used by the machine and the required network settings. For details, contact the network administrator.
- Check that the computer and router to be used in the network are properly connected, and complete the network settings. For details on the connection method, see the manuals of the devices or contact the manufacturer.

### ■ Network Settings Procedure

#### Step 1

Select whether to use wired or wireless LAN and connect to the network.

##### To connect to a Wired LAN

- [▶Selecting Wired or Wireless LAN\(P. 51\)](#)
- [▶Connecting to a Wired LAN\(P. 53\)](#)

##### To connect to a Wireless LAN

- [▶Selecting Wired or Wireless LAN\(P. 51\)](#)
- [▶Connecting to a Wireless LAN\(P. 54\)](#)



#### Step 2

Set the IP address.

- By default, when the machine connects to a wired or wireless LAN, an IP address is obtained automatically and set to the machine.
- To use a specific IP address, set this manually.
  - [▶Setting IPv4 Addresses\(P. 70\)](#)
  - [▶Setting IPv6 Addresses\(P. 74\)](#)

\* When setting an IP address manually, you cannot use the operation panel to configure some IPv6 address settings. It is recommended to use the operation panel to set the IPv4 address, and then use Remote UI to set the IPv6 address.



#### Step 3

Configure the settings of the machine according to the network environment, as needed.

▶ **Configuring Your Machine for Your Network Environment(P. 76)**

\* You cannot use the operation panel to configure some of the settings. It is recommended that you configure the settings using Remote UI in Step 3

■ **Checks after Configuring the Network Settings**

Check that the machine is properly connected to the network.

Check the IP address and MAC address of the machine and other information, as needed.

▶ **Checking the Network Status and Settings(P. 88)**

# Selecting Wired or Wireless LAN

94WS-018

Set whether to connect the machine to the network using a wired or wireless LAN.

If you want to switch from wired LAN to wireless LAN, you can make the setting during the procedure for connecting to wireless LAN. **▶ Connecting to a Wireless LAN(P. 54)**

\* You cannot connect to a wired LAN and wireless LAN at the same time.

Use the operation panel to configure the settings. On the operation panel, you can also configure the settings by pressing [Menu] in the [Home] screen ▶ [Preferences]. You cannot configure the settings using Remote UI from a computer.

Administrator privileges are required.

**▶ Touch Panel Model(P. 51)**

**▶ 5 Lines LCD Model(P. 51)**

## Touch Panel Model

**1** On the operation panel, press [Menu] in the [Home] screen. **▶ [Home] Screen(P. 113)**

**2** Press [Preferences] ▶ [Network] ▶ [Select Wired/Wireless LAN].

If the login screen appears, enter the System Manager ID and PIN, and then press [Log In]. **▶ System Manager ID and PIN(P. 6)**

**3** Select [Wired LAN] or [Wireless LAN].

⇒ The message [Settings applied.] appears.  
Next, connect to the wired or wireless LAN.

**▶ Connecting to a Wired LAN(P. 53)**

**▶ Connecting to a Wireless LAN(P. 54)**

## IMPORTANT

### When Switching between Wired and Wireless LAN

- Any installed drivers must be uninstalled and then reinstalled.  
For details about uninstalling and installing drivers, see the driver manual at the online manual site.  
<https://oip.manual.canon/>

## 5 Lines LCD Model

**1** On the operation panel, select [Menu] in the [Home] screen and press **OK**. **▶ [Home] Screen(P. 113)**

**2** Press [Preferences] ▶ **OK** ▶ [Network] ▶ **OK** ▶ [Select Wired/Wireless LAN] ▶ **OK**.

If the login screen appears, enter the System Manager ID and PIN, and then press [<Log In>] ► **OK** . ►  
**System Manager ID and PIN(P. 6)**

### **3** Select [**Wired LAN**] or [**Wireless LAN**] and press **OK**.

► The message [Settings applied.] appears.  
Next, connect to the wired or wireless LAN.

► **Connecting to a Wired LAN(P. 53)**

► **Connecting to a Wireless LAN(P. 54)**

## **IMPORTANT**

### **When Switching between Wired and Wireless LAN**

- Any installed drivers must be uninstalled and then reinstalled.  
For details about uninstalling and installing drivers, see the driver manual at the online manual site.  
**<https://oip.manual.canon/>**

## Connecting to a Wired LAN

---

94WS-019

Connect a computer to the machine via a router. Use an Ethernet cable to connect the machine to the router.

### 1 Connect an Ethernet cable to the machine and router.

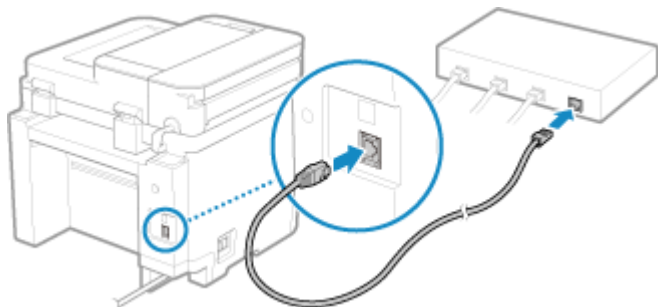

Insert the connector all the way into the port until it clicks in place.

### 2 Wait a few minutes.

▣ By default, the IP address is set automatically.  
To use a specific IP address, set this manually.

▶ **Setting IPv4 Addresses(P. 70)**

▶ **Setting IPv6 Addresses(P. 74)**

## Connecting to a Wireless LAN

94WS-01A

Connect a computer to the machine via a wireless LAN router (access point).

Depending on your wireless LAN router, the connection type and security standards may vary. Check for a connection type and security standard that are supported by both the wireless LAN router and the machine, and then establish a connection according to the connection type.

Depending on the connection type, you must enter the security information of the wireless LAN router.

▶ **Checking the Connection Types and Security Standards Supported by the Machine**(P. 54)

▶ **Wireless LAN Router Information Required for Connection**(P. 55)

### IMPORTANT

#### Connect with a Secure Network Environment

- The radio waves used for wireless communication can reach beyond walls and other obstructions within a certain range. Therefore, connecting the machine to a network without proper security measures may leak personal data and other information to third parties. Connect the machine to a wireless LAN at your own discretion and responsibility. ▶ **Protecting the Network**(P. 303)

### NOTE

#### Reducing Power Consumption

- When Power Save Mode is enabled, the machine regularly enters the power save state according to the signal transmitted by the wireless LAN router. ▶ **[Power Save Mode]**(P. 392)

## Checking the Connection Types and Security Standards Supported by the Machine

### ■ Connection Type

Connect using a type that is supported by your wireless LAN router. To specify the authentication, encryption, or other security method in detail, use the manual setup method to connect.

The following connection types are supported by the machine:

#### Push Button Mode (WPS)



If the wireless LAN router has the above symbol on the package or the button of the device, you can easily connect by pressing the button.

▶ **Connecting to a Wireless LAN by Using the Router Button (Push Button Mode)**(P. 57)

#### WPS PIN Code Mode

If you are using a WPS router that does not support the push button mode, enter the PIN code to connect.

▶ **Connecting to a Wireless LAN by Entering a PIN Code (WPS PIN Code Mode)**(P. 59)

\* If the wireless LAN router is set up to use WEP authentication, you may not be able to connect with WPS. In this case, use the manual setup method to connect.

## Access Point Setup Method

Search for the wireless LAN router from the machine, and enter the network key manually to connect.

### 🔍 Connecting to a Wireless LAN by Searching for a Router (Access Point Setup Method)(P. 62)

When you connect with the access point setup method, the following authentication and encryption methods are set:

- WEP authentication method: Open System
- Encryption for WPA/WPA2: AES-CCMP or TKIP is set automatically according to the selected wireless LAN router.

To specify a different authentication or encryption method, use the manual setup method to connect.

## Manual Setup Method

In addition to the SSID and network key, manually enter all the wireless LAN settings such as the authentication and encryption methods to connect.

### 🔍 Connecting to a Wireless LAN by Setting the Details (Manual Setup Method)(P. 65)

## ■ Security Standards

The wireless LAN of the machine supports the security standards below. For details on whether your wireless LAN router supports these standards, see the manual of the wireless LAN router or contact the manufacturer.

- WEP
- WPA-PSK
- WPA2-PSK
- WPA-EAP
- WPA2-EAP

## Wireless LAN Router Information Required for Connection

When connecting with the access point setup method or the manual setup method, you must set the information below.

This information is listed on the main unit of the wireless LAN router. For details, see the manual of the wireless LAN router or contact the manufacturer.

### SSID

This is the name used to identify the wireless LAN router. This may be listed as the access point name or network name.

### Network Key

This is the keyword used for data encryption or the password used for network authentication. This may be listed as the encryption key, WEP key, WPA/WPA2 passphrase, or pre-shared key (PSK).

### Security Standards

These are required when connecting with the manual setup method. Check the following information:

#### Security Standards

- WEP
- WPA-PSK
- WPA2-PSK
- WPA-EAP
- WPA2-EAP

#### WEP Authentication Method

- Open System



- Shared Key

**Encryption for WPA/WPA2**

- TKIP
- AES-CCMP
- IEEE 802.1X Authentication

# Connecting to a Wireless LAN by Using the Router Button (Push Button Mode)

94WS-01C

If your wireless LAN router supports WPS push button mode, you can easily set up a connection simply by using the operation panel of the machine and the button on the wireless LAN router.

Administrator privileges are required to connect to a wireless LAN.

▶ **Touch Panel Model(P. 57)**

▶ **5 Lines LCD Model(P. 58)**

## Touch Panel Model

### 1 On the operation panel, press [Wireless LAN Set.] in the [Home] screen. ▶ [Home] Screen(P. 113)

⇒ The [Select Network] screen is displayed.

- If the login screen appears, enter the System Manager ID and PIN, and then press [Log In]. ▶ **System Manager ID and PIN(P. 6)**
- If the message [Enable the wireless LAN?] appears, press [Yes].
- If the message [Cannot find the access point.] appears, press [Close].

### 2 Press [Other Connections].

### 3 Press [WPS Push Button Mode].

⇒ The machine starts searching for an access point.

### 4 After the search for an access point starts, press the button on the wireless LAN router within two minutes.

⇒ [Connected.] is displayed on the operation panel.

When the machine is connected to the wireless LAN, [  ] appears on the [Home] screen.

Press the button within two minutes. (Depending on the wireless LAN router, you may have to press and hold the button.)

\* For details on how to operate the button, see the manual of your wireless LAN router.

### 5 Wait a few minutes.

⇒ By default, an IP address is set automatically.

To use a specific IP address, set this manually.

▶ **Setting IPv4 Addresses(P. 70)**

▶ **Setting IPv6 Addresses(P. 74)**

## NOTE

### If an Error Message Appears during Operation and a Connection Cannot Be Established





- Press [Close], and repeat the procedure starting from Step 2.

## 5 Lines LCD Model

### 1 On the operation panel, select [Wireless LAN Set.] in the [Home] screen and press .

 [Home] Screen(P. 113)

⇒ The [Select Network] screen is displayed.

- If the login screen appears, enter the System Manager ID and PIN, and then press [<Log In>]  .
- **System Manager ID and PIN(P. 6)**
- If the message [Enable the wireless LAN?] appears, select [Yes] and press .
- If the message [Cannot find the access point.] appears, press .

### 2 Select [Other Connections] and press .

### 3 Select [WPS Push Button Mode] and press .

⇒ The machine starts searching for an access point.

### 4 After the search for an access point starts, press the button on the wireless LAN router within two minutes.

Press the button within two minutes. (Depending on the wireless LAN router, you may have to press and hold the button.)



\* For details on how to operate the button, see the manual of your wireless LAN router.

### 5 When [Connected.] appears on the operation panel, press .

⇒ When the machine is connected to the wireless LAN, [  ] appears on the [Home] screen.

### 6 Wait a few minutes.

⇒ By default, an IP address is set automatically.  
To use a specific IP address, set this manually.

-  **Setting IPv4 Addresses(P. 70)**
-  **Setting IPv6 Addresses(P. 74)**

## NOTE

### If an Error Message Appears during Operation and a Connection Cannot Be Established

- Press , and repeat the procedure starting from Step 2.

# Connecting to a Wireless LAN by Entering a PIN Code (WPS PIN Code Mode)

94WS-01E

When the wireless LAN router supports WPS PIN code mode, you can establish a connection by registering a PIN code generated on the machine to the wireless LAN router. Use a computer to register the PIN code.

Administrator privileges are required to connect to a wireless LAN.

## Required Preparations

- Access the wireless LAN router from a computer, and enable registration of a WPS PIN code.
  - \* For details on how to register a WPS PIN code, see the manual of your wireless LAN router.

▶ **Touch Panel Model(P. 59)**

▶ **5 Lines LCD Model(P. 60)**

## Touch Panel Model

### 1 On the operation panel, press [Wireless LAN Set.] in the [Home] screen. ▶ [Home] Screen(P. 113)

⇒ The [Select Network] screen is displayed.

- If the login screen appears, enter the System Manager ID and PIN, and then press [Log In]. ▶ **System Manager ID and PIN(P. 6)**
- If the message [Enable the wireless LAN?] appears, press [Yes].
- If the message [Cannot find the access point.] appears, press [Close].

### 2 Press [Other Connections].

### 3 Press [WPS PIN Code Mode].

⇒ A PIN code is generated.

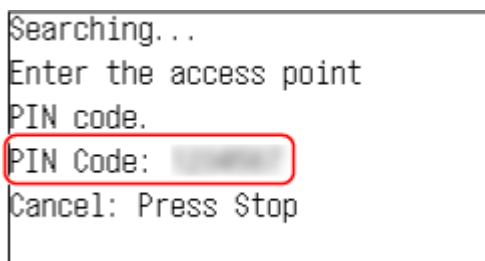

Once this screen is displayed, you must register the WPS PIN code to the wireless LAN router within 10 minutes.

### 4 Access the wireless LAN router from a computer, and register the WPS PIN code to the router.

⇒ [Connected.] is displayed on the operation panel.

When the machine is connected to the wireless LAN, [  ] appears on the [Home] screen.

## 5 Wait a few minutes.

⇒ By default, an IP address is set automatically.

To use a specific IP address, set this manually.

▶ **Setting IPv4 Addresses(P. 70)**

▶ **Setting IPv6 Addresses(P. 74)**

## NOTE

### If an Error Message Appears during Operation and a Connection Cannot Be Established

- Press [Close], and repeat the procedure starting from Step 2.

## 5 Lines LCD Model





### Required Preparations

- Access the wireless LAN router from a computer, and enable registration of a WPS PIN code.  
\* For details on how to register a WPS PIN code, see the manual of your wireless LAN router.

## 1 On the operation panel, select [Wireless LAN Set.] in the [Home] screen and press .

### ▶ [Home] Screen(P. 113)

⇒ The [Select Network] screen is displayed.

- If the login screen appears, enter the System Manager ID and PIN, and then press [<Log In>] ▶  . ▶ .
- **System Manager ID and PIN(P. 6)**
- If the message [Enable the wireless LAN?] appears, select [Yes] and press .
- If the message [Cannot find the access point.] appears, press .

## 2 Select [Other Connections] and press .

## 3 Select [WPS PIN Code Mode] and press .

⇒ A PIN code is generated.

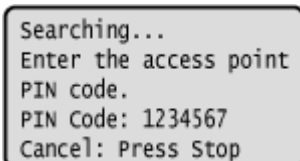

```
Searching...
Enter the access point
PIN code.
PIN Code: 1234567
Cancel: Press Stop
```

Once this screen is displayed, you must register the WPS PIN code to the wireless LAN router within 10 minutes.

**4** Access the wireless LAN router from a computer, and register the WPS PIN code to the router.

**5** When [Connected.] appears on the operation panel, press **OK**.

⇒ When the machine is connected to the wireless LAN, [  ] appears on the [Home] screen.

**6** Wait a few minutes.

⇒ Wait a few minutes. By default, an IP address is set automatically.  
To use a specific IP address, set this manually.

▶ **Setting IPv4 Addresses(P. 70)**

▶ **Setting IPv6 Addresses(P. 74)**

## NOTE

### If an Error Message Appears during Operation and a Connection Cannot Be Established

- Press **OK**, and repeat the procedure starting from Step 2.

# Connecting to a Wireless LAN by Searching for a Router (Access Point Setup Method)

94WS-01F

Search for a wireless LAN router (access point) to which to connect, and enter the network key.

When you connect with the access point setup method, the following authentication and encryption methods are set:

- WEP authentication method: Open System
- Encryption for WPA/WPA2: AES-CCMP or TKIP is set automatically according to the selected wireless LAN router.

To specify a different authentication or encryption method, use the manual setup method to connect. ▶

**Connecting to a Wireless LAN by Setting the Details (Manual Setup Method)(P. 65)**

Administrator privileges are required to connect to a wireless LAN.

▶ **Touch Panel Model(P. 62)**

▶ **5 Lines LCD Model(P. 63)**

## Touch Panel Model

### Required Preparations

- Prepare the information of the wireless LAN router (SSID or network key) to which you want to connect, and keep it close by. ▶ **Wireless LAN Router Information Required for Connection(P. 55)**
- When connecting to a wireless LAN router supporting WPA-EAP or WPA2-EAP for the security standard, set IEEE 802.1X. ▶ **Using IEEE 802.1X(P. 312)**

## 1 On the operation panel, press [Wireless LAN Set.] in the [Home] screen. ▶ [Home] Screen(P. 113)

⇒ The [Select Network] screen is displayed.

- If the login screen appears, enter the System Manager ID and PIN, and then press [Log In]. ▶ **System Manager ID and PIN(P. 6)**
- If the message [Enable the wireless LAN?] appears, press [Yes].
- If the message [Cannot find the access point.] appears, check that the router is discoverable. ▶ **Cannot Connect to Wireless LAN(P. 526)**

## 2 Select the SSID of the wireless LAN to which you want to connect.

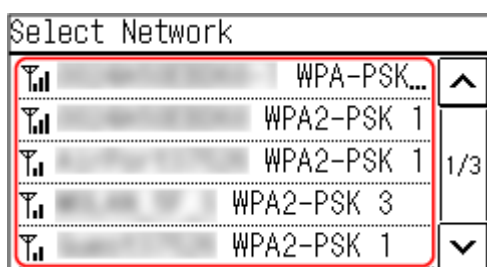

⇒ The Network Key input screen is displayed.

When selecting the SSID of the wireless LAN router supporting WPA-EAP or WPA2-EAP for the security standard, the message [IEEE 802.1X Settings values will be applied to connect.] appears. Press [OK], and proceed to Step 4.

If you cannot find the wireless LAN router to which you want to connect, check that the router is discoverable. ▶ **Cannot Connect to Wireless LAN(P. 526)**

### 3 Enter the network key, and press [Apply].

⇒ [Connected.] is displayed on the operation panel.

When the machine is connected to the wireless LAN, [  ] appears on the [Home] screen.

### 4 Wait a few minutes.

⇒ By default, an IP address is set automatically.

To use a specific IP address, set this manually.

▶ **Setting IPv4 Addresses(P. 70)**

▶ **Setting IPv6 Addresses(P. 74)**

## NOTE

### If an Error Message Appears during Operation and a Connection Cannot Be Established

- Press [Close], check the information (SSID or network key) of the wireless LAN router to which you want to connect, and repeat the procedure starting from Step 2.

## 5 Lines LCD Model



### Required Preparations

- Prepare the information of the wireless LAN router (SSID or network key) to which you want to connect, and keep it close by. ▶ **Wireless LAN Router Information Required for Connection(P. 55)**
- When connecting to a wireless LAN router supporting WPA-EAP or WPA2-EAP for the security standard, set IEEE 802.1X. ▶ **Using IEEE 802.1X(P. 312)**

### 1 On the operation panel, select [Wireless LAN Set.] in the [Home] screen and press .

▶ **[Home] Screen(P. 113)**

⇒ The [Select Network] screen is displayed.

- If the login screen appears, enter the System Manager ID and PIN, and then press [<Log In>] ▶  . ▶ **System Manager ID and PIN(P. 6)**
- If the message [Enable the wireless LAN?] appears, select [Yes] and press .
- If the message [Cannot find the access point.] appears, check that the router is discoverable. ▶ **Cannot Connect to Wireless LAN(P. 526)**

### 2 Select the SSID of the wireless LAN to which you want to connect, and press .



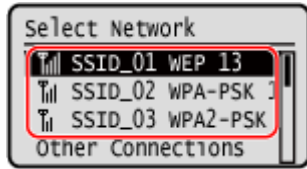

⇒ The Network Key input screen is displayed.

When selecting the SSID of the wireless LAN router supporting WPA-EAP or WPA2-EAP for the security standard, the message [IEEE 802.1X Settings values will be applied to connect.] appears. Press **OK**, and proceed to Step 4.

If you cannot find the wireless LAN router to which you want to connect, check that the router is discoverable. ▶ **Cannot Connect to Wireless LAN(P. 526)**

**3 Enter the network key, and press [<Apply>] ▶ **OK**.**

**4 Press [Yes] ▶ **OK**.**

**5 When [Connected.] is displayed on the operation panel, press **OK**.**

⇒ When the machine is connected to the wireless LAN, [**(p)**] appears on the [Home] screen.

**6 Wait a few minutes.**

⇒ By default, an IP address is set automatically.

To use a specific IP address, set this manually.

▶ **Setting IPv4 Addresses(P. 70)**

▶ **Setting IPv6 Addresses(P. 74)**

## NOTE

### If an Error Message Appears during Operation and a Connection Cannot Be Established

- Press **OK**, check the information (SSID or network key) of the wireless LAN router to which you want to connect, and repeat the procedure starting from Step 2.

# Connecting to a Wireless LAN by Setting the Details (Manual Setup Method)

94WS-01H

You can connect to a wireless LAN router by manually entering all information of the router such as the SSID, network key, and security settings.

Administrator privileges are required to connect to a wireless LAN.

▶ **Touch Panel Model(P. 65)**

▶ **5 Lines LCD Model(P. 67)**

## Touch Panel Model

### Required Preparations

- Prepare the information of the wireless LAN router to which you want to connect, and keep it close by. ▶ **Wireless LAN Router Information Required for Connection(P. 55)**
- When connecting to a wireless LAN router supporting WPA-EAP or WPA2-EAP for the security standard, set IEEE 802.1X. ▶ **Using IEEE 802.1X(P. 312)**

### 1 On the operation panel, press [Wireless LAN Set.] in the [Home] screen. ▶ [Home] Screen(P. 113)

⇒ The [Select Network] screen is displayed.

- If the login screen appears, enter the System Manager ID and PIN, and then press [Log In]. ▶ **System Manager ID and PIN(P. 6)**
- If the message [Enable the wireless LAN?] appears, press [Yes].
- If the message [Cannot find the access point.] appears, press [Close].

### 2 Press [Other Connections].

### 3 Press [Manually Enter Network Name].

⇒ The SSID input screen is displayed.

### 4 Enter the SSID, and press [Apply].

⇒ The [Security Settings] screen is displayed.

### 5 Select the security standard, and set the authentication and encryption.

#### ■ When using WEP

- 1 Press [WEP].

⇒ The [802.11 Authentication] screen is displayed.

- 2 Select the authentication method.

**[Open System]**

Uses open authentication.

\* When you select this authentication method, an authentication error occurs when connected to a wireless LAN router that uses a shared key. The machine setting changes to [Shared Key] at this time, and an attempt to reconnect to the router is made.

**[Shared Key]**

Uses an encryption key for the password.

- 3 Press [Edit Encryption Key].
- 4 Press an encryption key that is not registered.

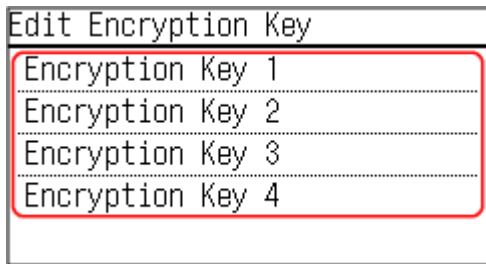

⇒ The encryption key input screen is displayed.

- 5 Enter the network key, and press [Apply].
- ⇒ The encryption key is registered to the [Encryption Key] screen.
- 6 Press [Select Encryption Key].
- 7 Press the registered encryption key.

**■ When Using WPA-PSK or WPA2-PSK**

- 1 Press [WPA/WPA2-PSK].
- ⇒ The [WPA/WPA2 Encryption] screen is displayed.
- 2 Select the encryption method.
- ⇒ The encryption key input screen is displayed.

When you select [Auto], AES-CCMP or TKIP is set automatically according to the wireless LAN router to which you want to connect.

- 3 Enter the network key, and press [Apply].

**■ When Using WPA-EAP or WPA2-EAP**

Press [WPA/WPA2-EAP] ► [OK].

**■ When Not Using a Security Standard**

Press [None].

- 6 Press [Yes].

⇒ [Connected.] is displayed.

When the machine is connected to the wireless LAN, [  ] appears on the [Home] screen and screen of each function.

## 7 Wait a few minutes.

- ⇒ By default, an IP address is set automatically.  
To use a specific IP address, set this manually.
  - ▶ **Setting IPv4 Addresses(P. 70)**
  - ▶ **Setting IPv6 Addresses(P. 74)**

## NOTE

### If an Error Message Appears during Operation and a Connection Cannot Be Established

- Press [Close], check the information of the wireless LAN router to which you want to connect, and repeat the procedure starting from Step 2.

## 5 Lines LCD Model



### Required Preparations

- Prepare the information of the wireless LAN router to which you want to connect, and keep it close by. ▶ **Wireless LAN Router Information Required for Connection(P. 55)**
- When connecting to a wireless LAN router supporting WPA-EAP or WPA2-EAP for the security standard, set IEEE 802.1X. ▶ **Using IEEE 802.1X(P. 312)**

## 1 On the operation panel, select [Wireless LAN Set.] in the [Home] screen and press .

▶ **[Home] Screen(P. 113)**

⇒ The [Select Network] screen is displayed.

- If the login screen appears, enter the System Manager ID and PIN, and then press [<Log In>] ▶  ▶ ▶ **System Manager ID and PIN(P. 6)**
- If the message [Enable the wireless LAN?] appears, select [Yes] and press .
- If the message [Cannot find the access point.] appears, select [Close] and press .

## 2 Select [Other Connections] and press .

## 3 Select [Manually Enter Network Name] and press .

⇒ The SSID input screen is displayed.

## 4 Enter the SSID, select [<Apply>], and press .

⇒ The [Security Settings] screen is displayed.

## 5 Select the security standard, and set the authentication and encryption.

### ■ When using WEP

- 1 Select [WEP] and press **OK**.  
 ⇒ The [802.11 Authentication] screen is displayed.
- 2 Select the authentication method.

#### [Open System]

Uses open authentication.

\* When you select this authentication method, an authentication error occurs when connected to a wireless LAN router that uses a shared key. The machine setting changes to [Shared Key] at this time, and an attempt to reconnect to the router is made.

#### [Shared Key]

Uses an encryption key for the password.

- 3 Select [Edit Encryption Key] and press **OK**.
- 4 Select an encryption key that is not registered, and press **OK**.

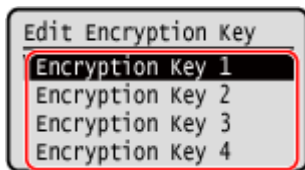

- ⇒ The encryption key input screen is displayed.
- 5 Enter the network key, select [<Apply>], and press **OK**.  
 ⇒ The encryption key is registered to the [Encryption Key] screen.
- 6 Select [Select Encryption Key] and press **OK**.
- 7 Select a registered encryption key, and press **OK**.

### ■ When Using WPA-PSK or WPA2-PSK

- 1 Select [WPA/WPA2-PSK] and press **OK**.  
 ⇒ The [WPA/WPA2 Encryption] screen is displayed.
- 2 Select the encryption method and press **OK**.  
 ⇒ The encryption key input screen is displayed.

When you select [Auto], AES-CCMP or TKIP is set automatically according to the wireless LAN router to which you want to connect.

- 3 Enter the network key, select [<Apply>], and press **OK**.

### ■ When Using WPA-EAP or WPA2-EAP

Select [WPA/WPA2-EAP] and press **OK**.

■ **When Not Using a Security Standard**

Select [None] and press **OK**.

**6** Select [Yes] and press **OK**.

**7** When [Connected.] is displayed on the operation panel, press **OK**.

⇒ When the machine is connected to the wireless LAN, [  ] appears on the [Home] screen.

**8** Wait a few minutes.

⇒ By default, an IP address is set automatically.

To use a specific IP address, set this manually.

▶ **Setting IPv4 Addresses(P. 70)**

▶ **Setting IPv6 Addresses(P. 74)**

## NOTE

### If an Error Message Appears during Operation and a Connection Cannot Be Established

- Press **OK**, check the information of the wireless LAN router to which you want to connect, and repeat the procedure starting from Step 2.

# Setting IPv4 Addresses

The machine's IPv4 address can either be assigned automatically using DHCP or entered manually. By default, the IPv4 address is set automatically when connected to a wired or wireless LAN, but you can set it or change it manually according to your usage environment and purpose.

This section describes how to configure the settings using the operation panel.

You can also set the IPv4 address using Remote UI from a computer after it has been set on the machine. **Managing the Machine from a Computer (Remote UI)(P. 348)**

Administrator privileges are required. The machine must be restarted to apply the settings.

**Touch Panel Model(P. 70)**

**5 Lines LCD Model(P. 71)**

## Touch Panel Model

**1** On the operation panel, press [Menu] in the [Home] screen. **[Home] Screen(P. 113)**

**2** Press [Preferences] ▶ [Network] ▶ [TCP/IP Settings] ▶ [IPv4 Settings] ▶ [IP Address Settings].

If the login screen appears, enter the System Manager ID and PIN, and then press [Log In]. **System Manager ID and PIN(P. 6)**

**3** Set the IP address.

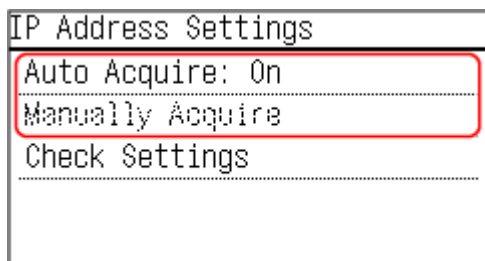

### ■ When Manually Setting the IP Address

- 1** Press [Auto Acquire].  
 ↳ The [Auto Acquire] screen is displayed.
- 2** Press [Select Protocol] ▶ [Off].
- 3** Press [Auto IP] ▶ [Off].
- 4** Press [Apply].  
 ↳ The [IP Address Settings] screen is displayed.
- 5** Press [Manually Acquire].  
 ↳ The IP address input screen is displayed.
- 6** Enter the IP address and press [Apply].
- 7** Enter the subnet mask and press [Apply].

- 8 Enter the gateway address and press [Apply].

### ■ When Assigning an IP Address Automatically

- 1 Press [Auto Acquire].  
 ⇒ The [Auto Acquire] screen is displayed.
- 2 Configure the Auto Acquire setting, as needed.

#### [Select Protocol]

Normally, set to [DHCP]. However, when [DHCP] is set in an environment where DHCP cannot be used, the machine will continue to confirm Auto Acquire in the network, creating unnecessary communication. When not using DHCP, set this to [Off].

#### [Auto IP]

Normally, set to [On]. Although priority is given to the IP address allocated with DHCP, if there is no response from DHCP, Auto IP will be used.

- 3 Press [Apply].

## 4 Restart the machine. ▶ Restarting the Machine(P. 106)

⇒ The settings are applied.

Perform a connection test to check whether the IPv4 address is correctly configured. ▶ Checking the Network Status and Settings(P. 88)

## NOTE

### Checking the Currently Set IP Address

- On the screen in Step 3, press [Check Settings] to check the current IP address setting. If the IP address is displayed as "0.0.0.0," it is not correctly configured.

### If the IP Address Is Changed after Installing the Printer Driver

- In Windows, the required action depends on the port you are using.
  - If you are using an MFNP port, the connection is maintained as long as the machine and computer belong to the same subnet, so no action is required on the computer.
  - If you are using a standard TCP/IP port, you must add a new port. ▶ Adding a Port(P. 176)

If you do not know which port is being used, see the following:

#### ▶ Viewing the Printer Port(P. 596)

- In macOS, you must re-register the machine on the Mac. For details about registering the machine, see the manual of the driver at the online manual site.

<https://oip.manual.canon/>

\* If you are using DHCP to automatically obtain the IP address of the machine, the IP address may be changed automatically.

## 5 Lines LCD Model

- 1 On the operation panel, select [Menu] in the [Home] screen, and press **OK**. ▶ [Home] Screen(P. 113)



- 2** Press [Preferences] ► **OK** ► [Network] ► **OK** ► [TCP/IP Settings] ► **OK** ► [IPv4 Settings] ► **OK** ► [IP Address Settings] ► **OK**.

If the login screen appears, enter the System Manager ID and PIN, and then press [<Log In>] ► **OK** .

**System Manager ID and PIN(P. 6)**

### 3 Set the IP address.

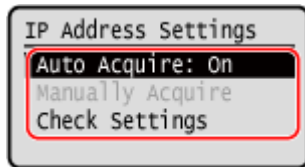

#### ■ When Manually Setting the IP Address

- 1** Select [Auto Acquire] and press **OK**.  
 ⇒ The [Auto Acquire] screen is displayed.
- 2** Press [Select Protocol] ► **OK** ► [Off] ► **OK**.
- 3** Press [Auto IP] ► **OK** ► [Off] ► **OK**.
- 4** Select [<Apply>] and press **OK**.  
 ⇒ The [IP Address Settings] screen is displayed.
- 5** Select [Manually Acquire] and press **OK**.  
 ⇒ The IP address input screen is displayed.
- 6** Enter the IP address and press **OK**.
- 7** Enter the subnet mask and press **OK**.
- 8** Enter the gateway address and press **OK**.

#### ■ When Assigning an IP Address Automatically

- 1** Select [Auto Acquire] and press **OK**.  
 ⇒ The [Auto Acquire] screen is displayed.
- 2** Configure the Auto Acquire setting, as needed.

##### [Select Protocol]

Normally, set to [DHCP]. However, when [DHCP] is set in an environment where DHCP cannot be used, the machine will continue to confirm Auto Acquire in the network, creating unnecessary communication. When not using DHCP, set this to [Off].

##### [Auto IP]

Normally, set to [On]. Although priority is given to the IP address allocated with DHCP, if there is no response from DHCP, Auto IP will be used.

- 3** Select [<Apply>] and press **OK**.

## 4 Restart the machine. ▶ Restarting the Machine(P. 106)

⇒ The settings are applied.

Perform a connection test to check whether the IPv4 address is correctly configured. ▶ **Checking the Network Status and Settings(P. 88)**

## NOTE

### Checking the Currently Set IP Address

- On the screen in Step 3, select [Check Settings] and press **OK** to check the current IP address setting. If the IP address is displayed as "0.0.0.0," it is not correctly configured.

### If the IP Address Is Changed after Installing the Printer Driver

- In Windows, you must add a new port. ▶ **Configuring a Printer Port (Windows)(P. 176)**  
If you do not know which port is being used, see the following:  
▶ **Viewing the Printer Port(P. 596)**
- In macOS, you must re-register the machine on the Mac. For details about registering the machine, see the manual of the driver at the online manual site.

<https://oip.manual.canon/>

\* If you are using DHCP to automatically obtain the IP address of the machine, the IP address may be changed automatically.

# Setting IPv6 Addresses

94WS-01K

In an IPv6 environment, you can set the following IPv6 addresses and use them at the same time.

- **Link-Local Address**  
An address that can only be used within the same link. It cannot be used to communicate with devices beyond a router.  
A link-local address is automatically set when usage of IPv6 addresses is enabled.
- **Stateless Address**  
An address that is generated automatically using the network prefix provided by the router and the MAC address of the machine.  
This address is discarded when the machine is restarted or turned ON.
- **Manual Address**  
An address that is entered manually by specifying the IP address, prefix length, and default router address.
- **Stateful Address**  
An address obtained from a DHCP server using DHCPv6.

This section describes how to configure the settings using Remote UI from a computer. On the operation panel, select [Menu] in the [Home] screen, and then select [Preferences] to configure the settings. You cannot use the operation panel to configure some of the settings. ▶**[IPv6 Settings](P. 395)**  
Administrator privileges are required. The machine must be restarted to apply the settings.

## Required Preparations

- Set an IPv4 address to the machine. ▶**Setting IPv4 Addresses(P. 70)**

## IMPORTANT

- In an IPv6 environment, you cannot use the function for scanning originals and saving the data to a computer.

- 1 Log in to Remote UI in System Manager Mode.** ▶**Starting Remote UI(P. 349)**
- 2 On the Portal page of Remote UI, click [Settings/Registration].** ▶**Portal Page of Remote UI(P. 351)**
- 3 Click [Network Settings] ▶ [IPv6 Settings] ▶ [Edit].**  
 ▶▶ The [Edit IPv6 Settings] screen is displayed.
- 4 In [IP Address Settings], select the [Use IPv6] checkbox.**
- 5 Set the IPv6 address to use.**

■ **When Using a Stateless Address**

Select the [Use Stateless Address] checkbox.

■ **When Using a Manual Address**

Select the [Use Manual Address] checkbox, and enter the IP address, prefix length, and default router address.

\* You cannot enter a multicast address (address starting with "ff").

■ **When Using a Stateful Address**

Select the [Use DHCPv6] checkbox.

**6** Click [OK].

**7** Restart the machine. ▶ **Restarting the Machine(P. 106)**

⇒ The settings are applied.

Perform a connection test to check whether the IPv6 address is correctly configured. ▶ **Checking the Network Status and Settings(P. 88)**

## NOTE

### If the IP Address Is Changed after Installing the Printer Driver

- You must add a new port. ▶ **Adding a Port(P. 176)**

# Configuring Your Machine for Your Network Environment

---

94WS-01L

The size and configuration of a network vary depending on the purpose and usage. The machine is equipped with a variety of technologies to support many environments.

Configure the settings of the machine according to your network environment, as needed.

- ▶ **Manually Configuring the Ethernet Settings(P. 77)**
- ▶ **Configuring DNS(P. 78)**
- ▶ **Configuring WINS(P. 82)**
- ▶ **Configuring SNMP(P. 83)**
- ▶ **Configuring SNTP(P. 86)**

## ■ See Also

To reduce the threat of unauthorized access and eavesdropping, it is recommended to configure the security settings according to your network environment.

- ▶ **Protecting the Network(P. 303)**

## NOTE

### Using the Machine in a Network with IEEE 802.1X Authentication

- When connecting the machine to a network that uses IEEE 802.1X authentication, you must configure the settings on the machine such as the authentication method managed by the authentication server. ▶ **Using IEEE 802.1X(P. 312)**

# Manually Configuring the Ethernet Settings

---

94WS-01R

By default, when the machine connects to a wired LAN, the Ethernet communication mode and Ethernet type are detected automatically, and these can be used without changes. Depending on the usage environment, you may have to change the Ethernet settings to suit the settings of peripheral devices.

This section describes how to configure the settings using Remote UI from a computer.

On the operation panel, select [Menu] in the [Home] screen, and then select [Preferences] to configure the settings. ▶  
**[Ethernet Driver Settings](P. 388)**

Administrator privileges are required. The machine must be restarted to apply the settings.

## 1 Log in to Remote UI in System Manager Mode. ▶Starting Remote UI(P. 349)

## 2 On the Portal page of Remote UI, click [Settings/Registration]. ▶Portal Page of Remote UI(P. 351)

## 3 Click [Network Settings] ▶ [Ethernet Driver Settings] ▶ [Edit].

⇒ The [Edit Ethernet Driver Settings] screen is displayed.

## 4 Clear the [Auto Detect] checkbox.

## 5 Select the communication mode.

Normally, select [Full Duplex]. When the network router is set to half duplex communication, select [Half Duplex].

## 6 Select the Ethernet type, and click [OK].

## 7 Restart the machine. ▶Restarting the Machine(P. 106)

⇒ The settings are applied.

# Configuring DNS

94WS-01S

When using the machine in an environment with Domain Name System (DNS), configure the DNS server information and DHCP option settings.

In an environment without DNS, you can configure multicast DNS (mDNS) to use the DNS function. mDNS is used by Bonjour and other software.

This section describes how to configure the settings using Remote UI from a computer.

On the operation panel, select [Menu] in the [Home] screen, and then select [Preferences] to configure the settings.

You cannot use the operation panel to configure some of the settings. [▶\[TCP/IP Settings\]\(P. 393\)](#)

Administrator privileges are required. Depending on the item to be configured, you may have to restart the machine.

## Required Preparations

- When configuring DNS for IPv6, configure the setting to use an IPv6 address. [▶Setting IPv6 Addresses\(P. 74\)](#)

**1 Log in to Remote UI in System Manager Mode.** [▶Starting Remote UI\(P. 349\)](#)

**2 On the Portal page of Remote UI, click [Settings/Registration].** [▶Portal Page of Remote UI\(P. 351\)](#)

**3 Click [Network Settings] ▶ [IPv4 Settings] or [IPv6 Settings] ▶ [Edit].**

⇒ The [Edit IPv4 Settings] screen or [Edit IPv6 Settings] screen is displayed.

**4 In [DHCP Option Settings], configure the DHCP option settings.**

If you are not configuring the DHCP option settings, proceed to Step 5.

Select the checkboxes of the items to enable.

### **[Acquire Host Name] (IPv4 only)**

Obtains a host name (Option 12) from the DHCP server.

### **[DNS Dynamic Update] (IPv4 only)**

The DHCP server automatically updates the information (Option 81) corresponding to the host name in place of the machine.

### **[Acquire DNS Server Address]**

Obtains a DNS server address (Option 6 for IPv4, Option 23 for IPv6) from the DHCP server.

### **[Acquire Domain Name]**

Obtains a domain name (Option 15 for IPv4, Option 24 for IPv6) from the DHCP server.

### **[Acquire WINS Server Address] (IPv4 only)**

Obtains a WINS server address (Option 44) from the DHCP server.

**5 In [DNS Settings], set the DNS server information.**

- For details about the setting information, contact your provider or network administrator. You can also refer to the computer settings. **▶Viewing the Network Connection Information of the Computer(P. 594)**
- If you are not configuring the DNS server information, proceed to Step 6.

**[Primary DNS Server Address]**

Enter the IP address of the DNS server.

\* For IPv6, you cannot enter a multicast address (address starting with "ff").

**[Secondary DNS Server Address]**

When using a secondary DNS server, enter the IP address of that server.

\* For IPv6, you cannot enter a multicast address (address starting with "ff").

**[Use Same Host Name/Domain Name as IPv4] (IPv6 only)**

Select the checkbox to use the same host and domain names as in IPv4.

To set the IPv6 host name and domain name individually, clear this checkbox, and enter [Host Name] and [Domain Name].

**[Host Name]**

Enter the host name to register in the DNS server using single-byte alphanumeric characters.

**[Domain Name]**

Enter the domain name to which the machine belongs using single-byte alphanumeric characters.

**Input example:**

example.com

**[DNS Dynamic Update]**

Select the checkbox to automatically update the DNS records when the corresponding information of the host name and IP address is changed in a DHCP environment, for example.

**To Specify the Type of Address to Register to the DNS Server (IPv6 only)**

Depending on the type of address you want to register, select the [Register Manual Address], [Register Stateful Address], or [Register Stateless Address] checkbox.

**To Specify the Interval between Updates**

In [DNS Dynamic Update Interval], enter the interval at which to automatically update this information.

**6 In [mDNS Settings], configure the mDNS settings.**

If you are not configuring the mDNS settings, proceed to Step 7.

**For IPv4**

To use mDNS, select the [Use mDNS] checkbox, and enter the mDNS name.

**For IPv6**

To use mDNS, select the [Use mDNS] checkbox, and select whether to use the same mDNS name as IPv4.

- To use the mDNS name set with IPv4 also with IPv6, select the [Use Same mDNS Name as IPv4] checkbox.
- To configure the mDNS name of IPv6 individually, clear the [Use Same mDNS Name as IPv4] checkbox, and enter the mDNS name.

**7 Click [OK].****8 Restart the machine. ▶Restarting the Machine(P. 106)**



⇒ The settings are applied.

# Configuring SMB

94WS-01U

The Server Message Block (SMB) communication protocol is used to enable the machine as a shared printer on the network. Depending on the network environment, you may have to set the computer name and workgroup name of the machine

## Setting the Computer Name and Workgroup Name

Set the computer name used to identify the machine in a network and the workgroup name to identify the group that the machine belongs to.

Configure these settings using Remote UI from a computer. You cannot use the operation panel to configure the settings.

Administrator privileges are required. The machine must be restarted to apply the settings.

- 1 Log in to Remote UI in System Manager Mode. ▶ Starting Remote UI(P. 349)**
- 2 On the Portal page of Remote UI, click [Settings/Registration]. ▶ Portal Page of Remote UI(P. 351)**
- 3 Click [Network Settings] ▶ [Computer Name/Workgroup Name Settings] ▶ [Edit].**

⇒ The [Edit Computer Name/Workgroup Name Settings] screen is displayed.

- 4 Enter the computer name and workgroup name of the machine, and click [OK].**

Enter using single-byte alphanumeric characters.

### ■ In an Environment with WINS

- Select the [Use NetBIOS] checkbox.
- You cannot register names that start with an asterisk (\*) to the WINS server.

- 5 Restart the machine. ▶ Restarting the Machine(P. 106)**

⇒ The settings are applied.

# Configuring WINS

94WS-01W

When using the machine in a network environment that uses both NetBIOS and TCP/IP, configure Windows Internet Name Service (WINS) to convert the NetBIOS name to an IP address.  
To enable WINS, specify the WINS server. WINS cannot be used in an IPv6 environment.

This section describes how to configure the settings using Remote UI from a computer.  
On the operation panel, select [Menu] in the [Home] screen, and then select [Preferences] to configure the settings. ▶  
**[WINS Settings](P. 396)**  
Administrator privileges are required. The machine must be restarted to apply the settings.

## Required Preparations

- Set the computer name and workgroup name. ▶ **Setting the Computer Name and Workgroup Name(P. 81)**
- Prepare the IPv4 address of the WINS server and keep it close by.

**1 Log in to Remote UI in System Manager Mode.** ▶ **Starting Remote UI(P. 349)**

**2 On the Portal page of Remote UI, click [Settings/Registration].** ▶ **Portal Page of Remote UI(P. 351)**

**3 Click [Network Settings] ▶ [WINS Settings] ▶ [Edit].**

⇒ The [Edit WINS Settings] screen is displayed.

**4 Select the [WINS Resolution] checkbox.**

**5 Enter the IPv4 address of the WINS server, and click [OK].**

If the IP address of the WINS server is obtained from a DHCP server, the obtained IP address has priority. ▶ **Configuring DNS(P. 78)**

**6 Restart the machine.** ▶ **Restarting the Machine(P. 106)**

⇒ The settings are applied.

# Configuring SNMP

94WS-01Y

Simple Network Management Protocol (SNMP) is a protocol for monitoring and controlling communication devices in a network by accessing a Management Information Base (MIB). Configure these settings according to the purpose of use and environment of the machine.

The machine supports SNMPv1 and SNMPv3. You can also use both at the same time. Trap notification is not supported.

When SNMP management software is installed on the network, you can use the software to configure, monitor, and control the machine remotely from a computer. For more information, see the manual of the software you are using.

## SNMPv1

SNMPv1 defines the scope of communication using information called a "community name." As the community name is sent to the network in plain text, the security of the network is vulnerable. To ensure network security, disable SNMPv1 and use SNMPv3. When SNMPv1 is disabled, you will not be able to use some functions such as obtaining information from the machine using the printer driver.

## SNMPv3

SNMPv3 communicates using user information for SNMPv3. This protocol enables you to configure the authentication and encryption in the user information to monitor and control communication devices on the network with a solid security system.

This section describes how to configure the settings using Remote UI from a computer.

On the operation panel, select [Menu] in the [Home] screen, and then select [Preferences] to configure the settings. However, the operation panel can only be used to enable or disable SNMPv1 and SNMPv3. [▶\[SNMP Settings\]\(P. 387\)](#) Administrator privileges are required. The machine must be restarted to apply the settings.

### Required Preparations

- To configure SNMPv3, you must enable TLS. [▶Using TLS\(P. 310\)](#)

**1 Log in to Remote UI in System Manager Mode.** [▶Starting Remote UI\(P. 349\)](#)

**2 On the Portal page of Remote UI, click [Settings/Registration].** [▶Portal Page of Remote UI\(P. 351\)](#)

**3 Click [Network Settings] ▶ [SNMP Settings] ▶ [Edit].**

⇒ The [Edit SNMP Settings] screen is displayed.

**4 In [SNMPv1 Settings], set SNMPv1.**

### ■ To Enable SNMPv1

**1** Select the [Use SNMPv1] checkbox.

**2** Configure the community.

- You can set MIB Access Permission (permission to read/write to MIB objects) for each community.
- When using both SNMPv1 and SNMPv3, it is recommended to set MIB Access Permission to [Read Only]. When setting SNMPv1 to [Read/Write] (full-access permission), you can perform nearly all operations, and therefore, you are not able to use the solid security features of SNMPv3.

**To Configure the Community Name**

Select the [Use Community Name 1] or [Use Community Name 2] checkbox, and configure the community name and MIB Access Permission.

Enter the community name using single-byte alphanumeric characters.

**To Configure a Dedicated Community**

Dedicated Community is a preset community for Canon Device Management software.

To use Dedicated Community, select the [Use Dedicated Community] checkbox, and configure MIB Access Permission.

\* For details, see the manual of the software you are using.

**■ To Disable SNMPv1**

Clear the [Use SNMPv1] checkbox.

**5 In [SNMPv3 Settings], configure SNMPv3.****■ To Enable SNMPv3**

- 1** Select the [Use SNMPv3] checkbox.
- 2** In [User Settings 1], [User Settings 2], or [User Settings 3], select the [Enable User] checkbox.
- 3** Configure the user.

**[User Name]**

Enter the user name using single-byte alphanumeric characters.

**[MIB Access Permission]**

Set the read/write permission to MIB objects for each specified user.

To allow both read and write, select [Read/Write].

**[Security Settings]**

Select whether to enable or disable authentication and encryption.

**[Authentication Algorithm]**

When [Authentication On/Encryption On] or [Authentication On/Encryption Off] is selected in [Security Settings], select the authentication algorithm according to the usage environment.

To set a password, select the [Set/Change Password] checkbox, and enter the same password in both [Authentication Password] and [Confirm] using single-byte alphanumeric characters.

**[Encryption Algorithm]**

When [Authentication On/Encryption On] is selected in [Security Settings], select the encryption algorithm according to the usage environment.

To set a password, select the [Set/Change Password] checkbox, and enter the same password in both [Encryption Password] and [Confirm] using single-byte alphanumeric characters.

**■ To Disable SNMPv3**

Clear the [Use SNMPv3] checkbox.

**6 In [Printer Management Information Acquisition Settings], select whether to obtain the printer management information.**

To regularly obtain printer management information from the machine, such as protocols and ports, select the [Acquire Printer Management Information from Host] checkbox.

**7 Click [OK].**

**8 Restart the machine. ▶Restarting the Machine(P. 106)**

⇒ The settings are applied.

## NOTE

### Changing the Port Number

- To change the port number of the SNMP server, see the following:  
▶**Changing the Port Number(P. 307)**

## Configuring SNTP

94WS-020

To obtain time information from the time server on the network, configure Simple Network Time Protocol (SNTP). When SNTP is configured, the time server is checked at specified intervals to adjust the time and maintain the correct time on the machine.

The machine supports both an NTP server (NTPv3) and SNTP server (SNTPv3 and v4).

Configure these settings using Remote UI from a computer. You cannot use the operation panel to configure the settings.

Administrator privileges are required. The machine must be restarted to apply the settings.

### Required Preparations

- The time is adjusted based on the UTC (Coordinated Universal Time), so specify the time zone setting. [▶ Setting the Date and Time\(P. 347\)](#)
- Prepare the IP address of the NTP or SNTP server and keep it close by.

**1 Log in to Remote UI in System Manager Mode.** [▶ Starting Remote UI\(P. 349\)](#)

**2 On the Portal page of Remote UI, click [Settings/Registration].** [▶ Portal Page of Remote UI\(P. 351\)](#)

**3 Click [Network Settings] ▶ [SNTP Settings] ▶ [Edit].**

⇒ The [Edit SNTP Settings] screen is displayed.

**4 Select the [Use SNTP] checkbox.**

**5 In [NTP Server Name], enter the IP address of the NTP/SNTP server.**

When using a DNS server, you can enter the host name or FQDN instead of the IP address.

**Input example:**  
ntp.example.com

**6 In [Polling Interval], enter the interval at which to check the server and adjust the time.**

**7 Click [OK].**

**8 Restart the machine.** [▶ Restarting the Machine\(P. 106\)](#)

⇒ The settings are applied.

## NOTE

## Testing Communication with the NTP or SNTP Server

- Test communication using the following procedure: If the machine is correctly communicating with the server, [OK] appears in [NTP Server Check Result].

Log in to Remote UI in System Manager Mode ▶ click [Settings/Registration] ▶ [Network Settings] ▶ [SNTP Settings] ▶ [Check NTP Server].

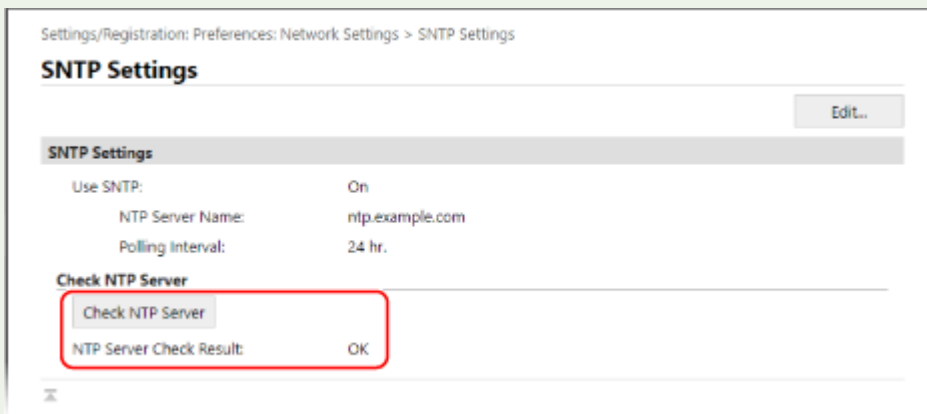

\* This tests the communication status and does not adjust the time.



# Checking the Network Status and Settings

94WS-022

You can perform a connection test with devices in the network to check whether the machine is correctly connected to the network.

The IP address of the machine and the MAC address information are needed to use Remote UI and configure the firewall settings. Check these current settings.

- ▶ **Checking Whether the Machine Can Connect to Network Devices(P. 88)**
- ▶ **Viewing the IP address set to the machine(P. 89)**
- ▶ **Viewing the MAC Address of the Wired LAN(P. 90)**
- ▶ **Viewing the MAC Address and Connection Information of the Wireless LAN(P. 91)**

## NOTE

- If the IP address is displayed as "0.0.0.0," it is not correctly configured. Set the IP address again.
  - ▶ **Setting IPv4 Addresses(P. 70)**
  - ▶ **Setting IPv6 Addresses(P. 74)**
- Connecting the machine to a switching hub, for example, may prevent connection to the network even when the IP address is correctly configured. In this case, set a wait time until machine starts communicating and try connecting again. ▶ **[Waiting Time for Connection at Startup](P. 388)**
- You can print the System Manager Data List to view the network settings. ▶ **Printing and Viewing Reports and Lists(P. 358)**

## Checking Whether the Machine Can Connect to Network Devices

In the Web browser of the computer connected to the network, enter the IPv4 or IPv6 address of the machine. If the Remote UI login screen is displayed, the machine is properly connected to the network. ▶ **Starting Remote UI(P. 349)**

When using an IPv4 address, you can use the following procedure to send a ping command from the operation panel to check whether the machine can connect to a network device.

- ▶ **Touch Panel Model(P. 88)**
- ▶ **5 Lines LCD Model(P. 89)**

### ■ Touch Panel Model

#### Required Preparations

- Prepare the IPv4 address of a device in the network to which you want to connect and keep it close by.

**1** On the operation panel, press [Menu] in the [Home] screen. ▶ **[Home] Screen(P. 113)**

**2** Press [Preferences] ▶ [Network] ▶ [TCP/IP Settings] ▶ [IPv4 Settings] ▶ [PING Command].

If the login screen appears, enter the System Manager ID and PIN, and then press [Log In]. ▶ **System Manager ID and PIN(P. 6)**

### 3 Enter the IPv4 address of a network device, and press [Apply].

⇒ If the machine is correctly connected to the network, [Received response from host.] appears.



#### ■ 5 Lines LCD Model

##### Required Preparations

- Prepare the IPv4 address of a device in the network to which you want to connect and keep it close by.

### 1 On the operation panel, select [Menu] in the [Home] screen, and press . [Home] Screen(P. 113)

### 2 Press [Preferences] [Network] [TCP/IP Settings] [IPv4 Settings] [PING Command] .

If the login screen appears, enter the System Manager ID and PIN, and then press [**<Log In>**]  .

**System Manager ID and PIN(P. 6)**

### 3 Enter the IPv4 address of a network device, and press .

⇒ If the machine is correctly connected to the network, [Received response from host.] appears.

## Viewing the IP address set to the machine

You can view the setting of IP address set to the machine such as the IPv4 address and the IPv6 address.

This section describes how to view the IP address using the operation panel.

You can also check this information using Remote UI from a computer.  **Managing the Machine from a Computer (Remote UI)(P. 348)**

 **Touch Panel Model(P. 89)**

 **5 Lines LCD Model(P. 90)**

#### ■ Touch Panel Model

### 1 Press on the operation panel.

⇒ The [Status Monitor] screen is displayed.

### 2 Press [Network Information] [IPv4] or [IPv6].

### 3 View the setting.

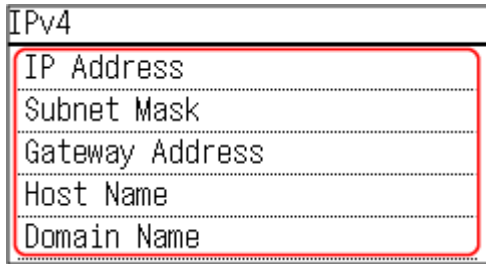

For IPv6, select the item you want to view, and the setting of that item will be displayed.

## ■ 5 Lines LCD Model

### 1 Press [Status Monitor] in the [Home] screen. ◀[Home] Screen(P. 113)

⇒ The [Status Monitor] screen is displayed.

### 2 Press [Network Information] ▶ [OK] ▶ [IPv4] or [IPv6] ▶ [OK].

### 3 View the setting and press [OK].

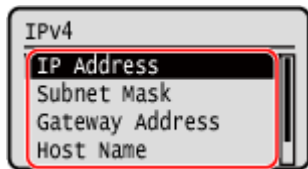

## Viewing the MAC Address of the Wired LAN

You can view the MAC address set to the machine when the machine is connected to the wired LAN.

This section describes how to view this information using the operation panel.

You can also use Remote UI from a computer to view the MAC address. ▶**Managing the Machine from a Computer (Remote UI)(P. 348)**

Administrator privileges are required.

▶**Touch Panel Model(P. 90)**

▶**5 Lines LCD Model(P. 91)**

## ■ Touch Panel Model

### 1 On the operation panel, press [Menu] in the [Home] screen. ▶[Home] Screen(P. 113)

### 2 Press [Preferences] ▶ [Network] ▶ [Ethernet Driver Settings].

If the login screen appears, enter the System Manager ID and PIN, and then press [Log In]. ▶**System Manager ID and PIN(P. 6)**

### 3 View the MAC address.

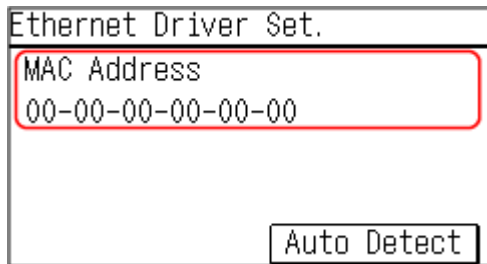

## ■ 5 Lines LCD Model

**1** On the operation panel, select [Menu] in the [Home] screen, and press **OK**. **▶**[Home] Screen(P. 113)

**2** Press [Preferences] **▶** **OK** **▶** [Network] **▶** **OK** **▶** [Ethernet Driver Settings] **▶** **OK**.

If the login screen appears, enter the System Manager ID and PIN, and then press [<Log In>] **▶** **OK**. **▶** System Manager ID and PIN(P. 6)

**3** View the MAC address.

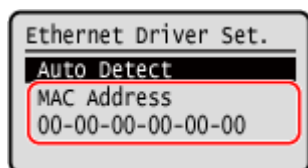

## Viewing the MAC Address and Connection Information of the Wireless LAN

In addition to the MAC address and connection information of the wireless LAN when the machine is connected to the wireless LAN, you can also view the security settings.

This section describes how to view this information using the operation panel.

You can also check this information using Remote UI from a computer. **▶**Managing the Machine from a Computer (Remote UI)(P. 348)

Administrator privileges are required.

**▶**Touch Panel Model(P. 91)

**▶**5 Lines LCD Model(P. 92)

## ■ Touch Panel Model

**1** On the operation panel, press [Wireless LAN Set.] in the [Home] screen. **▶**[Home] Screen(P. 113)

⇒ The [Select Network] screen is displayed.

If the login screen appears, enter the System Manager ID and PIN, and then press [Log In]. **▶**System Manager ID and PIN(P. 6)

**2** Press [Connection Settings] **▶** [Connection Information].

### 3 View the MAC address and the settings.

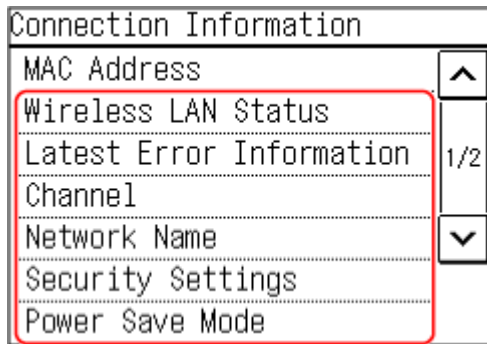

- Press [Latest Error Information] to display error information related to the wireless LAN connection.
- Press [Security Settings] to display the WEP or WPA/WPA2-PSK details.

## NOTE

### Viewing Information with the [Status Monitor] Screen

- You can also view the wireless LAN status and error information with the following procedure:



On the operation panel, Press  ► [Network Information] ► [Network Connection Method].

## ■ 5 Lines LCD Model

### 1 On the operation panel, select [Wireless LAN Set.] in the [Home] screen and press .

► [Home] Screen (P. 113)

⇒ The [Select Network] screen is displayed.



If the login screen appears, enter the System Manager ID and PIN, and then press [<Log In>] ►  . 

System Manager ID and PIN (P. 6)

### 2 Press [Connection Settings] ► ► [Connection Information] ► .

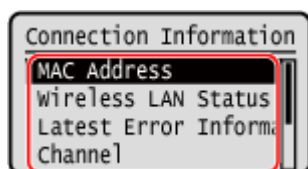
### 3 View the MAC address and the settings.





- Select [Latest Error Information] and press  to display error information related to the wireless LAN connection.
- Select [Security Settings] and press  to display the WEP or WPA/WPA2-PSK details.

## NOTE

### Viewing Information with the [Status Monitor] Screen

- You can also view the wireless LAN status and error information with the following procedure:

[Status Monitor] in the [Home] screen ▶ [Network Information] ▶  ▶ [Network Connection Method] ▶  ▶ [Connection Information] ▶ .

# Configuring the Fax Settings (Fax Setup Guide) (Touch Panel Model)

94WS-023

When you press [Fax] in the [Home] screen on the operation panel for the first time, the screen (Fax Setup Guide) for setting the items so as to use the fax is displayed. Configure the fax settings using the procedure below by following the instructions on the screen.

The machine must be restarted to apply the settings configured with the Fax Setup Guide.

- ▶ **Step 1: Starting the Fax Setup Guide(P. 94)**
- ▶ **Step 2: Registering the Fax Number and Unit Name(P. 94)**
- ▶ **Step 3: Setting the RX Mode(P. 95)**
- ▶ **Step 4: Connecting to Telephone Line(P. 96)**

## Step 1: Starting the Fax Setup Guide

### 1 On the operation panel, press [Fax] in the [Home] screen. ▶ [Home] Screen(P. 113)

⇒ The [Fax Setup Guide] screen is displayed.

#### ■ When the [Fax Setup Guide] Screen Is Not Displayed

If the [Fax Setup Guide] screen is not displayed after pressing [Fax] in the [Home] screen, or to reset the fax with the Fax Setup Guide, use the following procedure to display the [Fax Setup Guide].

[Home] screen on the operation panel ▶ [Menu] ▶ [Function Settings] ▶ [Common] ▶ [Fax Setup Guide].

### 2 Press [Set Up Now] ▶ [Next].

⇒ The [Register Unit Tel. No.] screen is displayed.

## Step 2: Registering the Fax Number and Unit Name

Register the fax number and unit name (name or company name). This information is printed together with the fax data at the destination.

### 1 On the [Register Unit Tel. No.] screen, enter the fax number of the machine, and press [Apply].

⇒ After the message [Settings applied.] appears, the screen guiding you to register the unit name is displayed.

### 2 Press [Next].

⇒ The [Register Unit Name] screen is displayed.

### 3 Enter the name or company name, and press [Apply].

➡ After the message [Settings applied.] appears, the [RX Mode Settings] screen is displayed.

## Step 3: Setting the RX Mode

Answer the questions on the screen to select the proper RX mode.

### 1 On the RX mode settings screen, press [Next].

### 2 Answer the questions displayed on the screen by pressing [Yes] or [No].

➡ When you have completed answering all the questions, the selected RX mode is displayed on the screen.

#### When Connecting the Optional TELEPHONE 6 KIT

- For the question [Do you want to connect a telephone to the device?], press [Yes].
- For the question [Do you want to use the answering machine of the telephone to be connected to the device?], press [No].

### 3 Check the selected RX mode.

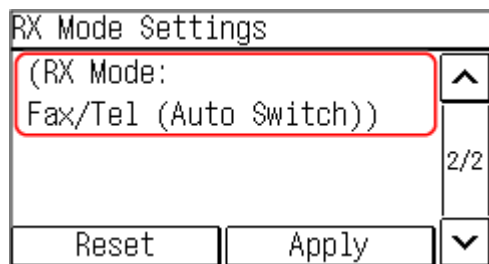

The RX modes operate as follows:

\* Depending on your country, [Net Switch] is also available for the receiving mode. ▶ **Changing Fax RX Mode and Setting the Action when Receiving a Fax(P. 215)**

#### [Fax/Tel (Auto Switch)]

Enables use of both fax and telephone.

- Faxes are automatically received.
- When a telephone call is received, the machine rings. Pick up the handset to answer the call.

#### [Auto]

Used for fax only.

- Faxes are automatically received.
- Incoming telephone calls cannot be answered.

#### [Answering Machine]

Enables use of both fax and phone.

- Faxes are automatically received.
- When a telephone call is received, the answering machine function can be used to record messages. You can answer the call by picking up the handset before recording starts.

\* Set the answering machine so that the recording function activates after the machine rings one or two times.

\* When recording your message, it is recommended that you keep about four seconds of silence, or keep the entire message within 20 seconds.

#### [Manual]



Enables use of both fax and phone.

- The machine rings when receiving both fax and phone calls.
- If you hear a fax tone when picking up the handset, receive the fax manually. ▶ **Receiving Faxes(P. 231)**
- You can also configure the setting to receive faxes automatically after the machine rings for a certain period of time. ▶ **[Switch to Auto RX](P. 445)**

#### 4 Press [Apply].

⇒ The [Connect Telephone Line] screen is displayed.

### Step 4: Connecting to Telephone Line

Use the supplied telephone cord to connect the machine to the telephone line.  
When using a telephone or the optional TELEPHONE 6 KIT, connect it to the machine.

#### 1 Connect the supplied telephone cord to the telephone line jack (LINE) on the machine and the telephone line connector on the wall.

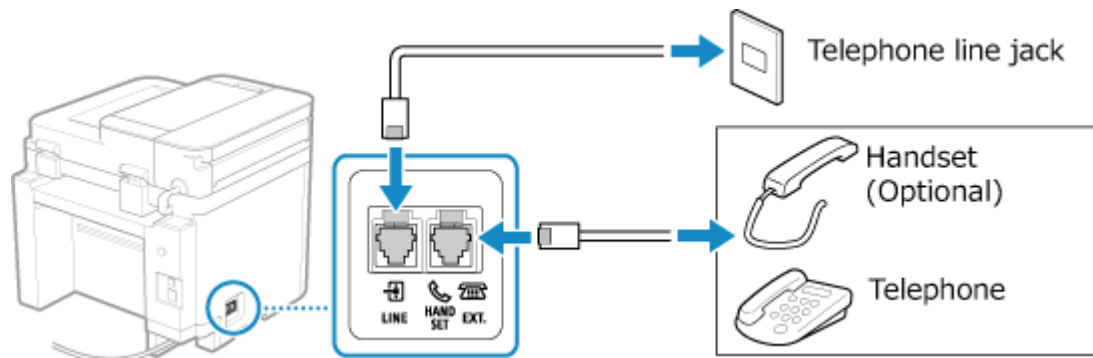

Connect the handset or telephone to the external telephone jack (EXT.) on the machine.

- When connecting a telephone with fax function, be sure to disable the fax auto receive setting on the telephone.
- Depending on the type of telephone connected to it, the machine may not be able to send or receive faxes properly.

#### 2 On the screen confirming that you want to exit the Fax Setup Guide, press [Yes].

#### 3 Restart the machine. ▶ **Restarting the Machine(P. 106)**

⇒ The settings configured in the Fax Setup Guide are applied, and the type of telephone line is configured automatically.

## NOTE

### If the Type of Telephone Line Is Not Configured Automatically

- Configure the type of telephone line manually. ▶ **[Select Line Type](P. 437)**

\* If you do not know the type of your telephone line, contact your telephone company. Depending on your country, [Select Line Type] may not be available.

## Making an Alert Sound When the Handset Is Not Properly Set on the Cradle

- You can select whether the machine makes an alert sound when the handset of a telephone or the optional TELEPHONE 6 KIT connected to the machine is not properly set on the cradle.

Log in to Remote UI ▶ [Settings/Registration] ▶ [TX Settings] ▶ [Fax TX Settings] ▶ [Edit] ▶ Select the [Off-Hook Alarm] checkbox and adjust the volume ▶ [OK]

On the operation panel, select [Menu] in the [Home] screen, and then select [Function Settings] to configure the settings.  **[Off-Hook Alarm](P. 435)**

# Installing Software and Drivers to the Computer

94WS-024

Install the related software and drivers to the computer that will use the functions of the machine, such as printing, remote scanning, and PC faxing.

Install any options to the machine before installing the software and drivers.

## Installation Procedure

Check the operating environment via the Canon website for your country/region, and download and install the latest software and drivers.

<https://global.canon/en/support/>

\* If the machine is supplied with a CD-ROM or DVD-ROM, you can also use this to install the software and drivers.

For details about the installation method, see the manual of the software or driver at the online manual site.

<https://oip.manual.canon/>

## Precautions and Limitations

### Operating Environment

- Depending on the operating system, your computer may not support some software or drivers. For the latest information on the supported operating systems, see the Canon website.

<https://global.canon/>

- Depending on the model and usage environment, some functions of the software or drivers may not be available.

### When the Firewall Settings of the Machine Are Configured

The computer that will be used with the machine must be allowed to communicate with the machine. If the computer is not allowed to communicate with the machine, you will not be able to install the software and drivers or use the functions of the machine. **▶Setting the Firewall(P. 304)**

### If the IP Address of the Machine Is Changed after Installing the Printer Driver

- In Windows, the required action depends on the port you are using.
  - If you are using an MFNP port, the connection is maintained as long as the machine and computer belong to the same subnet, so no action is required on the computer.
  - If you are using a standard TCP/IP port, you must add a new port. **▶Adding a Port(P. 176)**

If you do not know which port is being used, see the following:

**▶Viewing the Printer Port(P. 596)**

- In macOS, you must re-register the machine on the Mac. For details about registering the machine, see the manual of the driver at the online manual site.

<https://oip.manual.canon/>

\* If you are using DHCP to automatically obtain the IP address of the machine, the IP address may be changed automatically.

## NOTE

### Using the Functions of the Machine without Installing Software or Drivers (macOS)

- You can use AirPrint standard equipped in macOS to print and scan data and send faxes from a computer without installing software or drivers. **▶Using AirPrint Application to Print and Scan Data and Send Faxes(P. 293)**

# Basic Operations

<b>Basic Operations</b> .....	101
<b>Turning ON and OFF the Machine</b> .....	102
Turning ON the Machine .....	103
Turning OFF the Machine .....	104
Restarting the Machine .....	106
<b>Reducing Power Consumption (Sleep Mode)</b> .....	107
<b>Using the Operation Panel</b> .....	109
Screens Displayed on the Operation Panel .....	110
[Home] Screen .....	113
[Status Monitor] Screen .....	116
How to Operate the Operation Panel (Touch Panel Model) .....	118
How to Operate the Operation Panel (5 Lines LCD Model) .....	120
Entering Characters .....	122
Customizing the [Home] Screen .....	125
<b>Logging In to the Machine</b> .....	127
<b>Placing Originals</b> .....	129
<b>Loading Paper</b> .....	132
Loading Paper in the Paper Drawer .....	133
Preparations and Orientation for Loading Envelopes .....	135
Orientation for Loading Paper with a Logo .....	137
Specifying the Paper Size and Type .....	139
Setting the Paper Size and Type for the Paper Drawer .....	140
Registering Non-standard Size Paper (Custom Paper) .....	143
Hiding Unused Paper Sizes .....	145
<b>Registering Destinations (Address Book) (Touch Panel Model)</b> .....	147
Address Book Function (Touch Panel Model) .....	148
Registering Destinations to the Address Book (Operation Panel) (Touch Panel Model) .....	150
Registering Groups to the Address Book (Operation Panel) (Touch Panel Model) .....	152
Editing and Deleting Destinations in the Address Book (Operation Panel) (Touch Panel Model) .....	154
Registering Destinations to the Address Book (Remote UI) (Touch Panel Model) .....	155
Registering Groups to the Address Book (Remote UI) (Touch Panel Model) .....	157
<b>Specifying Destinations (Touch Panel Model)</b> .....	159
Specifying Destinations (Address Book) (Touch Panel Model) .....	160
Specifying Destinations (Direct Input) (Touch Panel Model) .....	162
Specifying Destinations (TX Job Log) (Touch Panel Model) .....	163

<b>To change the default settings</b> .....	164
Changing the Default Settings .....	165
<b>Adjusting the Sound Volume (Touch Panel Model)</b> .....	167
Adjusting the Volume (Touch Panel Model) .....	168
[Volume Settings] Screen (Touch Panel Model) .....	171

# Basic Operations

---

94WS-025

This chapter describes the basic operations common to all functions of the machine and how to understand the screen layout.

## Managing and Saving Power

You can turn OFF the power to conserve energy or when cleaning and restart the machine to apply the settings.

You can use sleep mode to reduce power consumption.

- ▶ **Turning ON and OFF the Machine(P. 102)**
- ▶ **Reducing Power Consumption (Sleep Mode)(P. 107)**

## Using the Operational Panel

Use the operation panel to scan, copy, and perform other functions and to configure the settings of the machine.

- ▶ **Using the Operation Panel(P. 109)**

When the login screen is displayed, enter the required login information to continue operations.

- ▶ **Logging In to the Machine(P. 127)**

## Placing Originals and Loading Paper

Place the original on the platen glass or in the feeder when scanning, sending a fax, or copying.

Load printing and copying paper into the paper drawer.

- ▶ **Placing Originals(P. 129)**
- ▶ **Loading Paper(P. 132)**

## Registering and Specifying Destinations (Touch Panel Model)

Register destinations for sending faxes to the Address Book of the machine.

In addition to specifying destinations from the Address Book, you can also directly enter them, use the TX Job Log, and use other methods to specify them.

- ▶ **Registering Destinations (Address Book) (Touch Panel Model)(P. 147)**
- ▶ **Specifying Destinations (Touch Panel Model)(P. 159)**

## Customizing Settings

You can change the settings for easier and more convenient use of the machine.

- ▶ **To change the default settings(P. 164)**
- ▶ **Adjusting the Volume (Touch Panel Model)(P. 168)**

## Turning ON and OFF the Machine

---

94WS-026

Use the power switch to manually turn ON and OFF the machine.

You can use this feature to automatically turn the machine OFF if no operations are performed after a certain period of time.

- ▶ **Turning ON the Machine(P. 103)**
- ▶ **Turning OFF the Machine(P. 104)**
- ▶ **Restarting the Machine(P. 106)**

## Turning ON the Machine

94WS-027

To turn ON the machine, press the power switch on the front.

**1** Make sure that the power plug is inserted into a power outlet.

**2** Press the power switch.

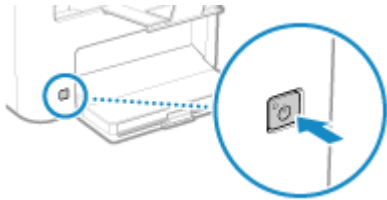

⇒ The start screen is displayed on the operation panel.

### NOTE

#### Changing the Screen that Appears at Startup

- After the power is turned ON and the start screen is displayed, the [Home] screen is displayed by default. You can configure the setting to display another function screen. ▶ **[Default Screen after Startup/Restoration](P. 379)**



# Turning OFF the Machine

94WS-028

To turn the machine OFF, press the power switch on the front. You can use this feature to automatically turn the machine OFF if no operations are performed after a certain period of time. Turning OFF the machine deletes any data waiting to be printed.

▶ **Turning OFF the Machine Using the Power Switch(P. 104)**

▶ **Setting the Machine to Automatically Turn Off(P. 104)**

## NOTE

- For the touch panel model, the following data remains stored without being deleted even if the machine is turned OFF:
  - Received data saved in the memory
  - Data waiting to be sent
  - Reports to be printed automatically after data is sent or received

## Turning OFF the Machine Using the Power Switch

**1 Press the power switch.**

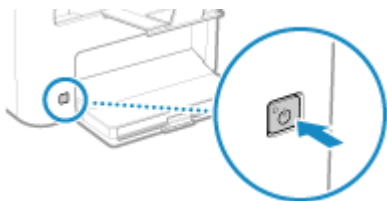

▶▶▶ The operation panel turns off, and the power turns OFF.

It may take a few minutes until the power turns OFF. Do not unplug the power cord until the power turns OFF.

## NOTE

### Turning ON the Machine Again

- Wait at least 10 seconds after turning OFF the power before turning ON the machine.

## Setting the Machine to Automatically Turn Off

This section describes how to configure the settings using Remote UI from a computer.

On the operation panel, select [Menu] in the [Home] screen, and then select [Preferences] to configure the settings. ▶ **[Auto Shutdown Time](P. 385)**

Administrator privileges are required.

**1 Log in to Remote UI in System Manager Mode. ▶ Starting Remote UI(P. 349)**

**2** On the Portal page of Remote UI, click [Settings/Registration]. ▶ Portal Page of Remote UI(P. 351)

**3** Click [Timer Settings] ▶ [Edit].

⇒ The [Edit Timer Settings] screen is displayed.

**4** Select the [Use Auto Shutdown Time] checkbox.

**5** In [Set Time], select the time until the machine is turned OFF.

**6** Click [OK].

⇒ The settings are applied.

**7** Log out from Remote UI.

## Restarting the Machine

94WS-029

When you make changes to the settings of the machine, you may have to restart the machine to apply the changes depending on the setting.

When you change the settings using either the operation panel or Remote UI, you can restart the machine using the power switch.

Restarting the machine deletes any data waiting to be printed.

### NOTE

- For the touch panel model, the following data remains stored without being deleted even if the machine is restarted:
  - Received data saved in the memory
  - Data waiting to be sent
  - Reports to be printed automatically after data is sent or received

### 1 Press the power switch.

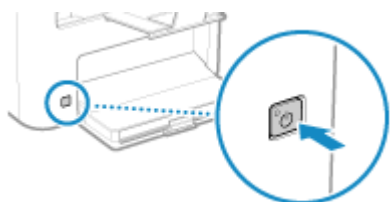

- ⇒ The operation panel turns off, and the power turns OFF.  
It may take a few minutes until the power turns OFF.

### 2 Wait at least 10 seconds after turning OFF the power before pressing the power switch.

- ⇒ The machine starts up.

## Reducing Power Consumption (Sleep Mode)

94WS-02A

Sleep mode reduces power consumption by pausing certain operations inside the machine.

### For Models with the Energy Saver Key ( )

On the operation panel, press [  ] to enter sleep mode. [▶Operation Panel\(P. 14\)](#)

Also, if no operations are performed for a certain period of time, the machine automatically enters sleep mode. [▶Configuring Auto Sleep Time\(P. 107\)](#)

When the machine is in sleep mode,  lights yellow-green.

### For Models without the Energy Saver Key ( )

You cannot manually put the machine into sleep mode. If no operations are performed for a certain period of time, the machine automatically enters sleep mode. [▶Configuring Auto Sleep Time\(P. 107\)](#)

The display turns off in sleep mode.

## ■ Exiting Sleep Mode

Perform any of the following operations:

- Press any key on the operation panel.
- Tap the display. (touch panel model)
- When a telephone or optional TELEPHONE 6 KIT is connected, take the handset off the hook. (touch panel model)

## ■ Configuring Auto Sleep Time

Auto Sleep is a function that automatically places the machine into sleep mode if no operations are performed for a certain period of time. You can specify the timing of Auto Sleep.

This section describes how to configure the settings using Remote UI from a computer.

On the operation panel, select [Menu] in the [Home] screen, and then select [Preferences] to configure the settings. [▶\[Timer/Energy Settings\]\(P. 383\)](#)

### 1 Log in to Remote UI. [▶Starting Remote UI\(P. 349\)](#)

### 2 On the Portal page of Remote UI, click [Settings/Registration]. [▶Portal Page of Remote UI\(P. 351\)](#)

### 3 Click [Timer Settings] ▶ [Edit].

⇒ The [Edit Timer Settings] screen is displayed.

### 4 Enter the time in [Auto Sleep Time].



\* It is recommended to use the default setting to efficiently save power. [▶\[Auto Sleep Time\]\(P. 385\)](#)

### 5 Click [OK].

⇒ The settings are applied.

## 6 Log out from Remote UI.

### IMPORTANT

Press  if the machine will not be used for a long period of time, such as overnight (for models with the Energy Saver key ()) only)

- Put the machine into sleep mode as a safety precaution.

### NOTE

- The machine does not enter sleep mode in the following cases:
  - When the data indicator on the operation panel is lit or blinking  **Operation Panel(P. 14)**
  - When the [Menu] screen, a paper jam or other error message<sup>\*1</sup>, or Direct Connection SSID or network key display screen is displayed on the operation panel
  - When the machine is performing an adjustment, cleaning, or other operation
  - When the machine is communicating with a computer or similar device
  - When a phone or optional TELEPHONE 6 KIT is connected, the handset is off the hook. (touch panel model)
  - When the incoming fax ring is turned off (touch panel model)

<sup>\*1</sup> The machine may enter sleep mode depending on the message.

## Using the Operation Panel

---

94WS-02C

Use the operation panel to change the settings of the machine and use the scan, copy, and other functions.

### Main Instructions

Check how to use the buttons and items displayed on the operation panel, how to enter text, and how to display the various screens.

- ▶ **Screens Displayed on the Operation Panel(P. 110)**
- ▶ **How to Operate the Operation Panel (Touch Panel Model)(P. 118)**
- ▶ **How to Operate the Operation Panel (5 Lines LCD Model)(P. 120)**
- ▶ **Entering Characters(P. 122)**

### Making the [Home] Screen Easier to Use

Rearrange the items on the [Home] screen so that you can access frequently used items more quickly. ▶  
**Customizing the [Home] Screen(P. 125)**

## IMPORTANT

### Regarding the Handling of the Touch Panel Display (Touch Panel Model)

- Do not press the touch panel display too hard. Doing so may break the touch panel display.
- Do not use an object with a sharp end, such as a mechanical pencil or ballpoint pen. Doing so may scratch the surface of the touch panel display or break it.
- Placing objects on the display or wiping the display may cause the touch panel to react and lead to a malfunction.

# Screens Displayed on the Operation Panel

94WS-02E

The following are the main screens of the operation panel.

## [Home] Screen

This screen is displayed when you press [] on the operation panel. By default, the [Home] screen is displayed after the power is turned ON and immediately after the startup screen closes, and immediately after logging in.

 [Home] Screen(P. 113)



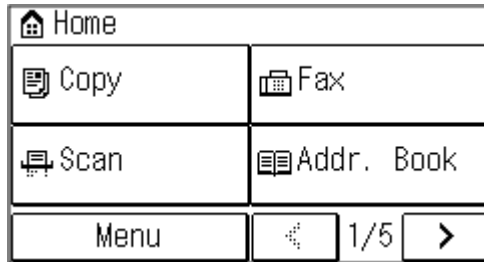

### Touch Panel Model

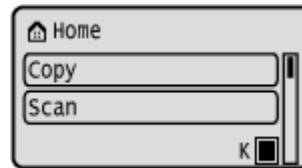

### 5 Lines LCD Model



## [Status Monitor] Screen

This screen is displayed when you press [] on the operation panel or press [Status Monitor]   on the [Home] screen and other locations. Use this screen to check the information of the machine, usage and logs, network settings, and error information.  [Status Monitor] Screen(P. 116)

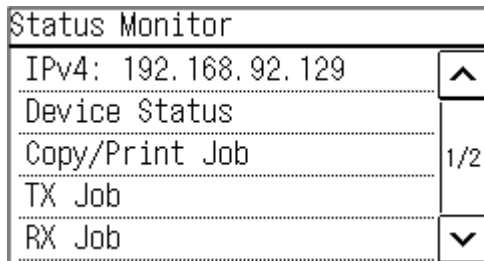

### Touch Panel Model

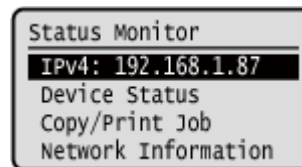

### 5 Lines LCD Model



## [Menu] Screen

This screen is displayed when you press [Menu] on the [Home] screen and other locations or press [Menu]   on the [Home] screen. Use this screen to configure the various settings of the machine.

When the System Manager ID is set, the login screen may be displayed when certain items are selected. Only users who know the System Manager ID and PIN can log in and change the settings.

### Touch Panel Model

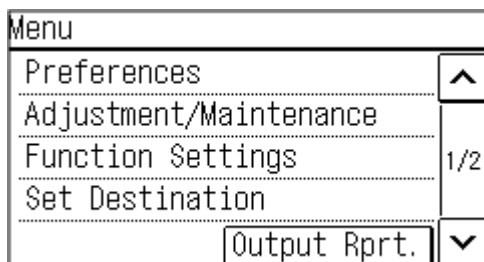

### 5 Lines LCD Model

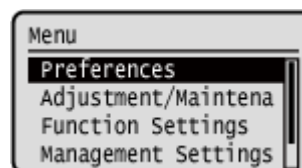

## Message Display

Messages are displayed on the screen when errors occur and the machine is out of paper or toner in the toner cartridge.

If a troubleshooting solution is displayed, follow the on-screen instructions to solve the problem.

If a troubleshooting solution is not displayed, check the cause and solution by referring to the message or error code.

▶ **A Message Appears(P. 560)**

▶ **An Error Code Is Displayed(P. 575)**

### Display example:

- **When an Error Occurs**

#### Touch Panel Model

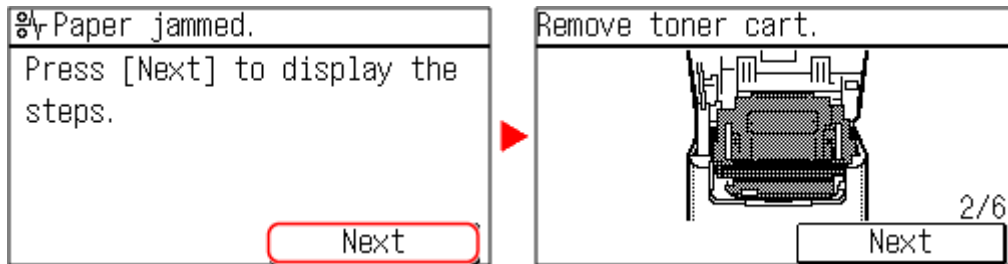

#### 5 Lines LCD Model

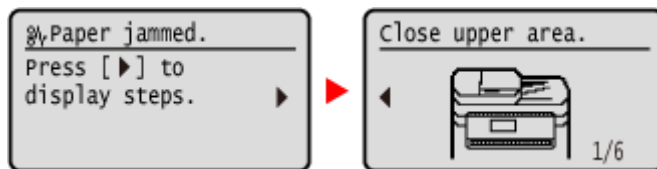

- **When a Message Appears on the Screen**

If the message is too long to display at once, it may be separated into smaller segments and displayed alternately.

#### Touch Panel Model

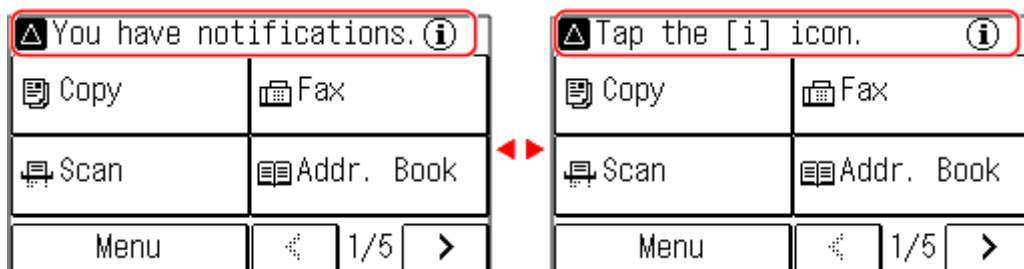

#### 5 Lines LCD Model

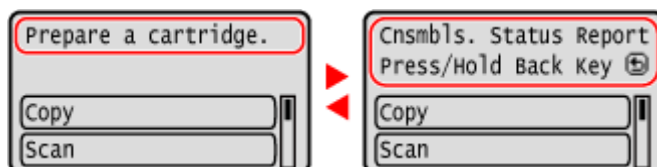

## NOTE



### Changing the Screen Display

- You can change the operation panel display such as by changing the display language and units, and show or hide messages. ▶ **[Display Settings](P. 379)**



- You can invert the screen colors and adjust the contrast to make the screen easier to view.  **[Accessibility]**  
**(P. 401)**

### Clearing the Settings Automatically

- By default, if no operations are performed after a certain period of time, the settings being configured on the screen are cleared, and the [Home] screen is displayed. You can change the time until the settings are cleared and the screen that is displayed after.
  -  **[Auto Reset Time](P. 384)**
  -  **[Function After Auto Reset](P. 384)**

## [Home] Screen

This screen is displayed when you press [] on the operation panel.

▶ **[Home] Screen of the Touch Panel Model(P. 113)**

▶ **[Home] Screen of the 5 Lines LCD Model(P. 114)**

### [Home] Screen of the Touch Panel Model

The status of the machine is displayed at the top of the screen for quick viewing and operations, as needed.

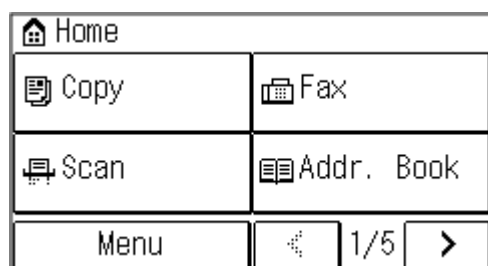

#### ■ Status of the Machine

[]

When connected to a wireless LAN, [] is displayed.

#### ■ Function and Setting Buttons

**[Menu]**

Configure the various settings of the machine. ▶ **Settings Menu Items(P. 376)**

**[Copy]**

Copies originals. ▶ **Copying(P. 239)**

**[Fax]**

Faxes documents. ▶ **Faxing(P. 211)**

**[Scan]**

Scans originals. ▶ **Scanning(P. 193)**

**[Addr. Book]**

Register destinations when sending faxes. You can specify destinations from the Address Book, and call up the send function.

▶ **Registering Destinations (Address Book) (Touch Panel Model)(P. 147)**

▶ **Specifying Destinations (Address Book) (Touch Panel Model)(P. 160)**

**[Paper Set.]**

Connect mobile devices to the machine. ▶ **Connecting a Mobile Device to the Machine(P. 286)**

**[Scan ▶ PC1] and [Scan ▶ PC2]**

Scan using the settings registered beforehand. ▶ **Scanning Using the Shortcut Key(P. 199)**

**[Paper Save]**

Copies 2-page or 4-page originals so that they fit onto a single sheet of paper. ▶ **Using Paper Save Copy(P. 256)**

**[ID Card Copy]**

Copies the front and back sides of ID cards. ▶ **Copying Both Sides of ID Cards onto One Sheet(P. 260)**

**[Passport Copy]**

Copies multiple passports onto one sheet of paper. [▶ Copying Multiple Passports onto One Sheet\(P. 264\)](#)

**[One-Touch 1] to [One-Touch 4]**

Register and recall frequently used destinations. [▶ Address Book Function \(Touch Panel Model\)\(P. 148\)](#)

**[Coded Dial]**

Enter a 3-digit number to recall the destination registered to that coded number. [▶ Address Book Function \(Touch Panel Model\)\(P. 148\)](#)

**[Mobile Portal]**

Connect mobile devices to the machine. [▶ Connecting a Mobile Device to the Machine\(P. 286\)](#)

**[Home Set.]**

You can change the display order of the items on the [Home] screen. [▶ Customizing the \[Home\] Screen\(P. 125\)](#)

**[Update Firmware]**

Updates the firmware via the Internet. [▶ Updating the Firmware \(Touch Panel Model\)\(P. 365\)](#)

**[Wireless LAN Set.]**

Connects a computer to the machine via a wireless LAN router (access point). [▶ Connecting to a Wireless LAN by Searching for a Router \(Access Point Setup Method\)\(P. 62\)](#)

**[Toner Delivery Set.]**

You can configure settings for toner replenishment service. Use of the toner replenishment service requires prior registration with select retailers. This service is only available in certain countries.

## [Home] Screen of the 5 Lines LCD Model

The status of the machine is displayed at the top and bottom of the screen for quick viewing and operations, as needed.

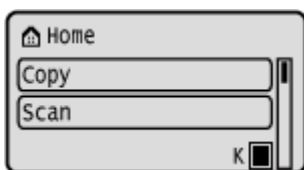

### ■ Status of the Machine

**[ (w) ]**

When connected to a wireless LAN, [ (w) ] is displayed.

**[ K ]**

Displays the remaining amount of toner in the toner cartridge.

### ■ Function and Setting Buttons

**[Copy]**

Copies originals. [▶ Copying\(P. 239\)](#)

**[Scan]**

Scans originals. [▶ Scanning\(P. 193\)](#)

**[Status Monitor]**

You can check the information of the machine, usage and logs, network settings, and error information. [▶ \[Status Monitor\] Screen\(P. 116\)](#)

**[Menu]**

Configure the various settings of the machine. [▶ Settings Menu Items\(P. 376\)](#)

**[Paper Settings]**

Set the paper size and type to use, and register frequently used paper. [▶Specifying the Paper Size and Type\(P. 139\)](#)

**[Scan ▶ PC]**

Scan using the settings registered beforehand. [▶Scanning Using the Shortcut Key\(P. 199\)](#)

**[Paper Save Copy]**

Copies 2-page or 4-page originals so that they fit onto a single sheet of paper. [▶Using Paper Save Copy\(P. 256\)](#)

**[Passport Copy]**

Copies multiple passports onto one sheet of paper. [▶Copying Multiple Passports onto One Sheet\(P. 264\)](#)

**[Mobile Portal]**

Connect mobile devices to the machine. [▶Connecting a Mobile Device to the Machine\(P. 286\)](#)

**[Display Order (Home)]**

You can change the display order of the items on the [Home] screen. [▶Customizing the \[Home\] Screen\(P. 125\)](#)

**[Update Firmware]**

Updates the firmware via the Internet. [▶Updating the Firmware \(5 Lines LCD Model\)\(P. 368\)](#)



**[Wireless LAN Set.]**

Connects a computer to the machine via a wireless LAN router (access point). [▶Connecting to a Wireless LAN by Searching for a Router \(Access Point Setup Method\)\(P. 62\)](#)

**[Toner Delivery Set.]**

You can configure settings for toner replenishment service. Use of the toner replenishment service requires prior registration with select retailers. This service is only available in certain countries.

## [Status Monitor] Screen

This screen is displayed when you press  on the operation panel or press [Status Monitor]   on the [Home] screen and other locations.

Use this screen to check the information of the machine, usage and logs, network settings, and error information.

### Touch Panel Model

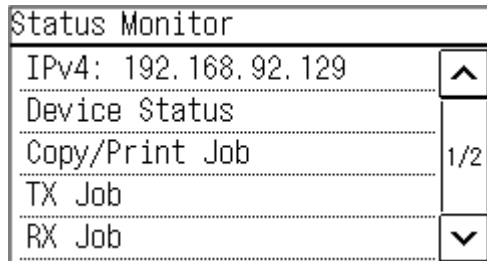

### 5 Lines LCD Model

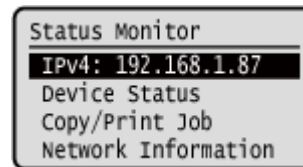

#### [IPv4]

Displays the IPv4 address of the machine by default. You can also hide this.  [\[Display IP Address\]\(P. 382\)](#)

#### [Error Information/Notification]

You can check the information of errors that occur on the machine. Take troubleshooting measures according to the error details.

-  [A Message Appears\(P. 560\)](#)
-  [An Error Code Is Displayed\(P. 575\)](#)

#### [Device Status]

##### [Paper Information]

Check the remaining amount of paper for the paper source.

##### [Cartridge Level]

Check the remaining amount of toner in the toner cartridge.  
Other internal parts may reach the end of their lifetime before the toner runs out.

##### [Check Toner Cartridge Name]

Check the toner cartridge name.

##### [Check Counter]

Check the total number of pages printed, faxed, and copied.  [Checking the Number of Printed Pages \(Check Counter\)\(P. 356\)](#)

##### [Version Information]

Displays the firmware version information of the machine.

##### [Serial Number]

Displays the serial number of the machine.



#### [Copy/Print Job]

Displays the copy or print processing status and log.

-  [Checking the Copy Status\(P. 270\)](#)
-  [Viewing the Print Job Status and Log\(P. 190\)](#)

#### [TX Job] (touch panel model only)

Displays the status and log of sent faxes.

-  [Checking the Save Status and Log of Scanned Data \(Touch Panel Model\)\(P. 209\)](#)
-  [Checking Sent and Received Faxes\(P. 236\)](#)

#### [RX Job] (touch panel model only)

Displays the status and log of received faxes.  [Checking Sent and Received Faxes\(P. 236\)](#)

**[Fax Forwarding Errors] (touch panel model only)**

If a fax could not be forwarded but remains in the memory, you can print it or forward it to a different destination, and view its content. [▶Checking Faxes that Failed to Be Forwarded\(P. 237\)](#)

**[Network Information]**

**[IPv4]**

Check the IPv4 address and other settings. [▶Setting IPv4 Addresses\(P. 70\)](#)

**[IPv6]**

Check the IPv6 address and other settings. [▶Setting IPv6 Addresses\(P. 74\)](#)

**[Network Connection Method]**

Check whether the machine has a wired or wireless connection.

Displays the connection status and error information when connected by wireless LAN.

**[Direct Connection Information]**

Displays the connection status when directly connected to a device.

**[IEEE 802.1X Error Information]**

Displays the details of errors that occur with IEEE 802.1X authentication.

# How to Operate the Operation Panel (Touch Panel Model)

94WS-02J

The operation panel uses a touchscreen. Directly touch your finger to the buttons and items displayed on the screen to operate them.

- ▶ **Basic Touchscreen Operations (Tapping, and Long Touch)(P. 118)**
- ▶ **Selecting Items(P. 118)**
- ▶ **Scrolling the Screen(P. 119)**
- ▶ **Set the value using the [+] and [-] buttons or the slider.(P. 119)**

## ! IMPORTANT

To prevent accidental operations or damage to the operation panel, avoid the following:

- Pressing too hard with your fingers
- Pressing with a sharp tip, such as a fingernail, ballpoint pen, or pencil
- Operating with wet or dirty hands
- Operating with an object on the display

## Basic Touchscreen Operations (Tapping, and Long Touch)

### Tapping

Gently touch the screen with your fingertip and quickly release. Do this when selecting items and performing operations.

In the User's Guide, "press" and "select" refer to the tapping operation.



### Long Touch

Keep finger held on the screen. When text cannot be completely displayed on one line ("..." appears), touch and hold the line to scroll all of the text. Also continuously increases/decreases the copy magnification.



## Selecting Items

When you tap an item name or button, the item can be selected. The selected screen is displayed, or the selected function is performed.

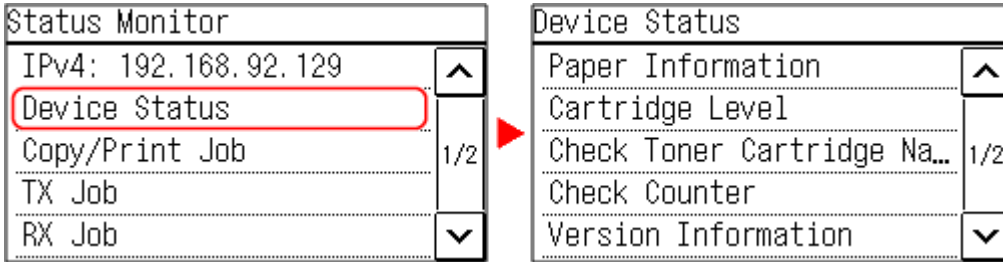

**To Cancel a Selection**

Drag your fingertip touching the screen away from the selected item or button and release it.

**To Return to the Previous Screen**

Tap [].

## Scrolling the Screen

When the scroll bar appears on the screen, it indicates that there are items or information that cannot be completely displayed on the screen. Tap [] or [] to scroll the screen. The screen changes page by page, and the page number is displayed in the scroll bar.

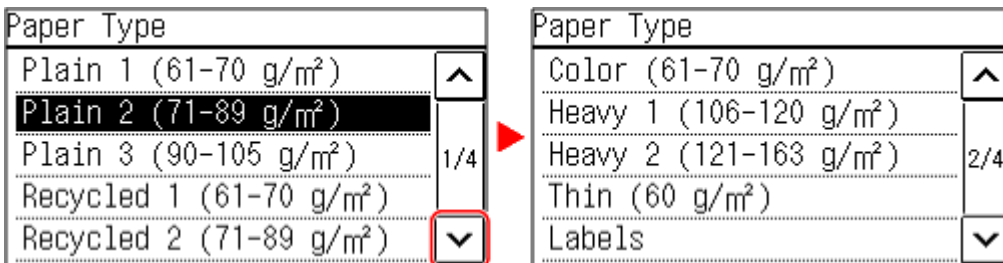

## Set the value using the [+] and [-] buttons or the slider.

Tap the [+] and [-] buttons to adjust the value. When the slider is displayed as shown below, you can drag it to the left or right to adjust the value.

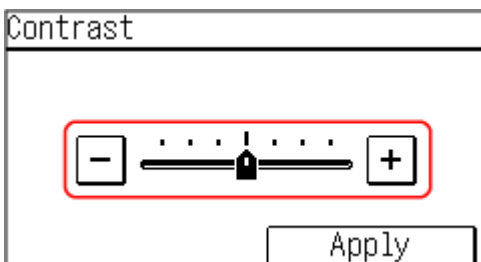



# How to Operate the Operation Panel (5 Lines LCD Model)

94WS-0J3

Use the keys on the operation panel to set the various functions and check the settings.

- ▶ **Scrolling the Screen(P. 120)**
- ▶ **Moving to the Next or Previous Screen(P. 120)**
- ▶ **Confirming a Selected Item(P. 120)**
- ▶ **Using the Slider to Set Values(P. 120)**

## Scrolling the Screen

When the scroll bar appears on the screen, it indicates that there are items or information that cannot be completely displayed on the screen. Use ▲ or ▼ to scroll the screen in the direction pressed. The currently selected item is inverted.

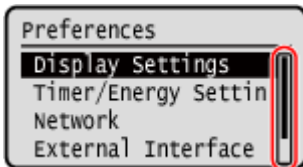

## Moving to the Next or Previous Screen

To move to the next screen, press **OK** or **▶**. To return to the previous screen, press **↶** or **◀**.

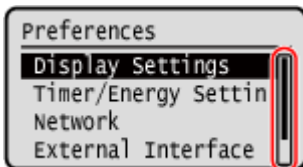

## Confirming a Selected Item

To confirm a selected item, press **OK**.

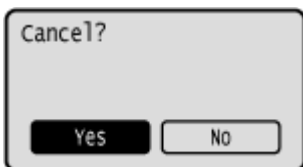

## Using the Slider to Set Values

To adjust the value, press **◀** or **▶**.

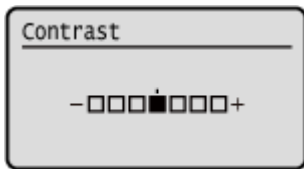

## Entering Characters

Enter alphanumeric characters using the keys and numeric keys on the operation panel or the keys displayed on the screen.

- ▶ **Entering Characters Using the Operation Panel (Touch Panel Model)(P. 122)**
- ▶ **Entering Characters Using Keys Displayed on the Operation Panel (5 Lines LCD Model)(P. 123)**

### Entering Characters Using the Operation Panel (Touch Panel Model)

You can enter letters, numbers, and symbols using the operation panel. The type of characters that you can enter may be limited depending on the item. If the value input range is limited, the value that you can enter is displayed in parentheses ( ) next to the input field.



#### Character Type

Tap [A/a/12] or press  to switch the type of character that is entered. The currently selected type of character is indicated by the "A", "a", or "12" displayed above and to the right of the text input field.

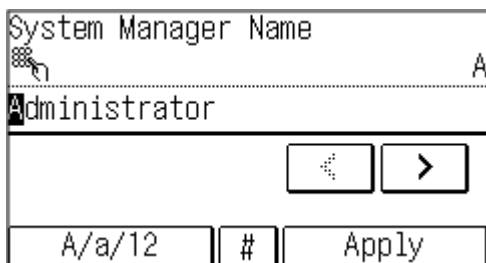





#### Entering Characters, Spaces, and Symbols

Enter characters and symbols using the numeric keys. The following are the usable keys and characters that can be entered:

You can enter a space by moving the cursor to the end of the characters and pressing .

When "A" or "a" is displayed above and to the right of the text input field and you press , symbols are displayed.

Key	A	a	12
	@ . - _ /		1
	ABC	abc	2
	DEF	def	3
	GHI	ghi	4

Key	A	a	12
	JKL	jkl	5
	MNO	mno	6
	PQRS	pqrs	7
	TUV	tuv	8
	WXYZ	wxyz	9
	(Not available)		0
	(space) -. * # ! " ; ; ^ ` _ = /   ' ? \$ @ % & + \ ~ ( ) [ ] { } < >	(Not available)	

**Deleting Characters**

Press to delete one character.

Press and hold to continuously delete characters.

**Moving the Cursor**

Press or .

**Entering Numbers**

Press or . You can also use the numeric keys to enter numbers when is displayed on the screen.

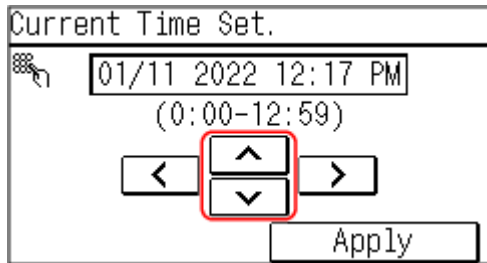

**Entering Characters Using Keys Displayed on the Operation Panel (5 Lines LCD Model)**

Use the on-screen keys to select the letters and numbers you want to enter and then press to enter the characters. You can enter letters, numbers, and symbols.

**Changing the Character Type**

Press [Switch Entry Mode] , select the character type and then press .

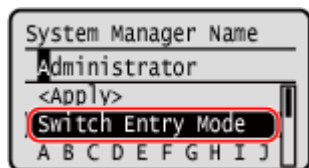

**Moving the Cursor**

Select [] or [] on the screen and then press .

**Deleting Characters**

Press [] on the screen to delete one character.

If [◀] or [▶] is not displayed, pressing [C] ▶ OK deletes all the characters.

**Entering Spaces**

Press [Space] ▶ OK.

You can also enter a space by moving the cursor to the end of the characters and pressing [▶] ▶ OK.

## Customizing the [Home] Screen

You can rearrange the items on the [Home] screen so that you can operate frequently used items more quickly.

- ▶ **Changing the Display Order of the Items (Touch Panel Model)(P. 125)**
- ▶ **Inserting a Blank (Touch Panel Model)(P. 125)**
- ▶ **Changing the Display Order of the Items (5 Lines LCD Model)(P. 126)**

### Changing the Display Order of the Items (Touch Panel Model)

#### 1 Press [Home Set.] in the [Home] screen. ▶[Home] Screen(P. 113)

If the login screen appears, enter the System Manager ID and PIN, and then click [Log In]. ▶**System Manager ID and PIN(P. 6)**

#### 2 Press [Set Display Order].

#### 3 Select the button to move.

#### 4 Select [Previous] or [Next] to move the button, and press [Apply].

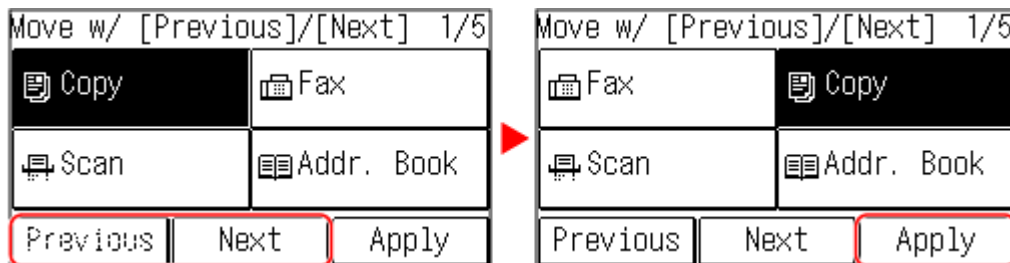

- The button moves as many times as you tapped.
- A long touch on [Previous] or [Next] moves the selected button continuously.

#### 5 Repeat steps 3 and 4 to move all buttons you want to move.

#### 6 Press [Apply].

⇒ The display order of the items on the [Home] screen is changed.

### Inserting a Blank (Touch Panel Model)

#### 1 Press [Home Set.] in the [Home] screen. ▶[Home] Screen(P. 113)

When the System Manager ID is set, the login screen may be displayed when certain items are selected. Only users who know the System Manager ID and PIN can log in and change the settings.

**2 Press [Insert and Delete Blank].**

**3 Select the button where you want to insert a blank, and select [Insert].**

To delete an inserted blank, select the blank, select [Delete], and proceed to step 5.

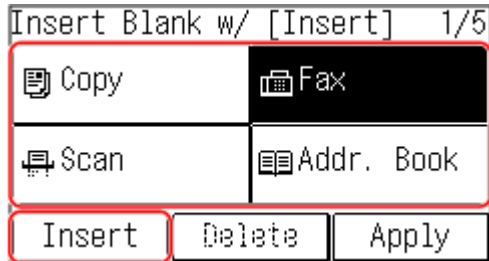

**4 Press [Apply].**

## Changing the Display Order of the Items (5 Lines LCD Model)

**1 On the [Home] screen of the operation panel, press [Display Order (Home)] ▶ **OK** . ▶ [Home] Screen(P. 113)**

**2 Use ▲ or ▼ to select the item you want to move, and then press **OK**.**

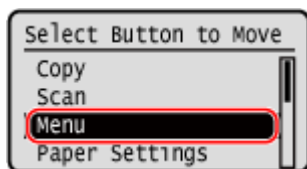

**3 Use ▲ or ▼ to move the item, and then press **OK**.**

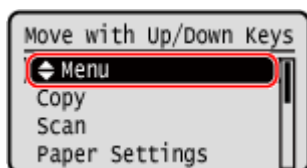

**4 Press **OK**.**

⇒ The display order of the items on the [Home] screen is changed.

# Logging In to the Machine

94WS-02S

When the System Manager ID is set, the login screen is displayed for operations that require administrator privileges. When the login screen is displayed on the operation panel, enter the the System Manager ID and PIN to perform authentication. When authentication is successful, the screen changes, and you can continue operations.

## Touch Panel Model

## 5 Lines LCD Model

▶ Touch Panel Model(P. 127)

▶ 5 Lines LCD Model(P. 127)

## Touch Panel Model

**1** Press [Manager ID:], and enter the System Manager ID.

**2** Press [Apply].

**3** Press [PIN:], and enter the PIN.

If a PIN is not set, you can skip this step. Proceed to Step 5.

**4** Press [Apply].

**5** Press [Log In].

⇒ When authentication is successful, the [Home] screen or other screen is displayed.

## 5 Lines LCD Model

**1** Press [Manager ID:] ▶ **OK**.

**2** Enter the System Manager ID, and press **OK**.



**3** Press [PIN:] ▶ **OK**.

If a PIN is not set, you can skip this step. Proceed to Step 5.

**4** Enter the PIN, and press **OK**.

**5** Press [<Log In>] ▶ **OK**.

⇒ When authentication is successful, the [Home] screen or other screen is displayed.

**6** When you have completed your operations, press **OK**.

# Placing Originals

94WS-02U

Place documents, photos, and other printed materials ("originals") to be scanned, faxed, or copied on the platen glass or in the feeder.

Determine whether to use the platen glass or feeder depending on the document type and usage.

## Platen Glass

Scans originals in a fixed position. Originals must be placed one at a time, but this ensures highly accurate scanning.

You can also place the following originals on the platen glass:

- Books, thick paper, thin paper, and other originals that cannot be placed in the feeder
- Tracing paper, transparencies, and other transparent originals

## ▶ Placing Originals on the Platen Glass(P. 129)

## Feeder

You can place two or more sheets of originals in the feeder. The placed originals are scanned automatically one sheet at a time.

## ▶ Placing Originals in the Feeder(P. 130)

## ! IMPORTANT

### Place Dry Originals

- Before placing originals, make sure that any ink, correction fluid, or glue on them has completely dried.

## Placing Originals on the Platen Glass

For the size of the originals that can be placed on the platen glass, see the basic specifications of the machine. ▶ **Basic Specifications(P. 24)**

### 1 Open the feeder or the platen glass cover.

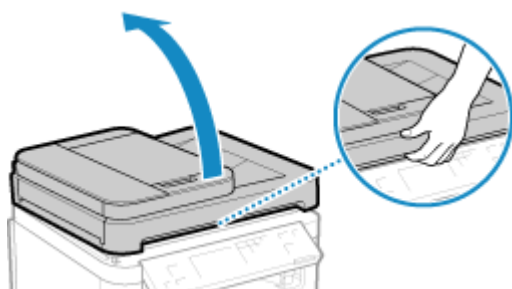

### 2 Place the side of the original to be scanned face down on the platen glass in the landscape orientation while aligning the corner of the original with the top left corner of the platen glass.

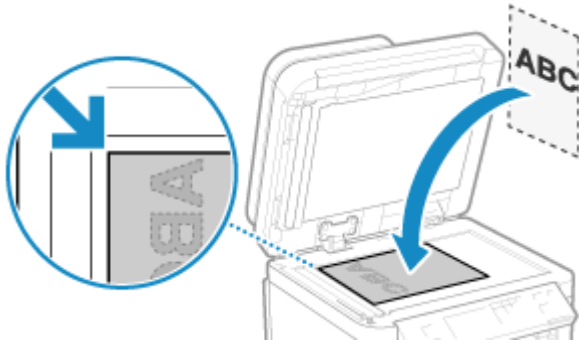

When scanning tracing paper, transparencies, and other transparent originals, place a sheet of plain white paper on top.

**3 Gently close the feeder or the platen glass cover.**

**4 When scanning of the original is complete, remove the original from the platen glass.**

## Placing Originals in the Feeder

When scanning two or more sheets of originals, place only originals of the same size.

For the size of the originals that can be placed in the feeder, see the specifications of the feeder. [▶ Feeder Specifications \(P. 27\)](#)

### **!** IMPORTANT

**To prevent paper jams inside the feeder, do not place the following originals:**

- Wrinkled, creased, curled, rolled, or torn paper
- Carbon paper, coated paper, thin translucent paper, thin paper, or transparencies
- Stapled or clipped paper
- Paper printed by a thermal transfer printer

**1 Open the original supply tray.**

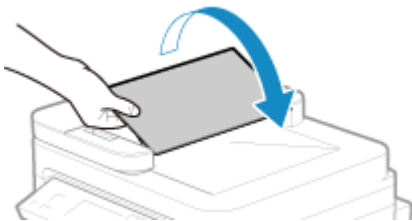

**2 Spread the slide guides outward until they are slightly farther apart than the width of the original.**



### 3 Fan the originals and align the edges.



Fan the originals in small batches, and align the edges by tapping the originals on a flat surface a few times.

### 4 Place the sides of the originals to be scanned face up in the feeder in the landscape orientation.

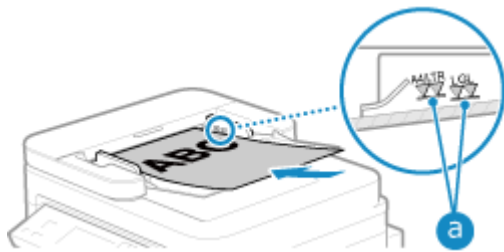

Make sure the placed originals do not exceed the load limit line (a). If they exceed the load limit line, there may be misfeeds or a paper jam.

#### ■When Loading A6 Size Paper

Place the A6 slide guides in the feeder.

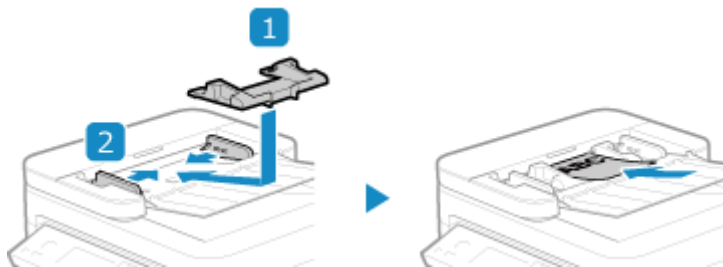

- Load the paper in portrait orientation (A6R).

### 5 Align the slide guides against the edges of the originals.



Slide guides that are aligned but too loose or too tight can cause misfeeds or a paper jam.

### 6 When scanning of the originals is complete, remove the ejected originals from below the feeder.

- Do not add originals or remove them during scanning.
- Leaving ejected originals below the feeder may cause a paper jam.

# Loading Paper

---

94WS-02W

To ensure print quality, confirm the usable paper and how to handle and store paper, and prepare the appropriate paper for use with the machine. [▶ Usable Paper\(P. 19\)](#) / [▶ Precautions When Handling Paper\(P. 22\)](#)

Load the prepared paper in the machine, and then configure the paper size and type settings.

## Loading Paper in the Machine

Load the paper in the paper drawer. When using envelopes or paper with logos, be careful of the orientation of the loaded paper and which side is face up.

- ▶ [Loading Paper in the Paper Drawer\(P. 133\)](#)
- ▶ [Preparations and Orientation for Loading Envelopes\(P. 135\)](#)
- ▶ [Orientation for Loading Paper with a Logo\(P. 137\)](#)

## Paper Settings

To ensure quality printing and prevent paper jams, the paper size and type must be set correctly according to the loaded paper.

- ▶ [Specifying the Paper Size and Type\(P. 139\)](#)

## Loading Paper in the Paper Drawer

94WS-02X

You can load paper correctly by aligning the paper guides on the paper drawer with the paper.

When using envelopes or paper with logos, be careful of the orientation of the loaded paper and which side is face up.

🔴 **Preparations and Orientation for Loading Envelopes(P. 135)**

🔴 **Orientation for Loading Paper with a Logo(P. 137)**

### 1 Open the front cover.

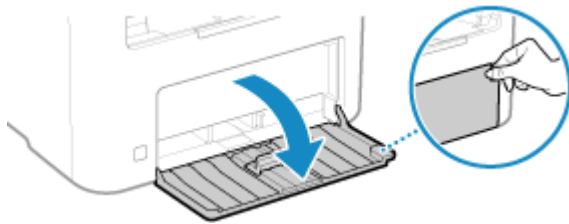

### 2 Slide the paper guides to the outside.

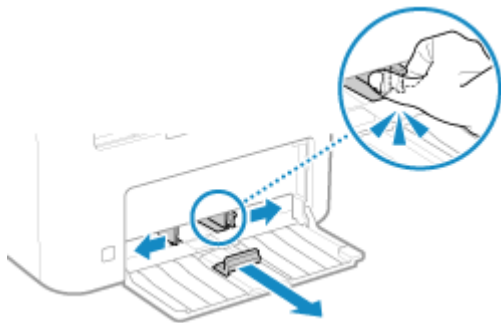

### 3 Fan the paper and align the edges.



Fan the paper in small batches, and align the edges by tapping the paper on a flat surface a few times.

### 4 Load the paper with the print side face up.

➡ By default, the Paper Settings confirmation screen is displayed. 🔴 **[Notify to Check Paper Settings]** (P. 454)

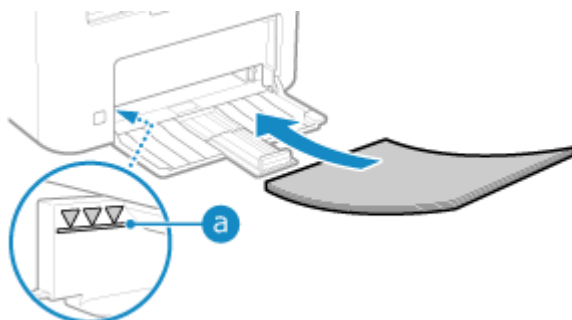

- Load the paper against the rear edge of the paper drawer.
- Make sure the loaded paper does not exceed the load limit line ( **a** ). If it exceeds the load limit line, there may be misfeeds or a paper jam.

### ■ When Printing on the Back Side of Printed Paper (Manual 2-sided Printing)

Flatten the edge of the paper to remove any curls, and load the paper with the back (unprinted) side face up.

- You can use only paper printed with this machine.
- You cannot print on a side that has been previously printed on.
- If the printouts look faded, adjust the image quality. ▶[Manual Back Side Print (2-Sided Only)](P. 408)

## 5 Align the paper guides with the width and length of the paper.

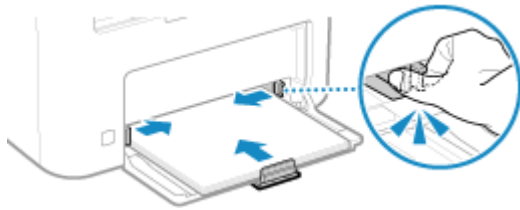

Paper guides that are aligned but too loose or too tight can cause misfeeds or a paper jam.

## 6 Close the paper cover.

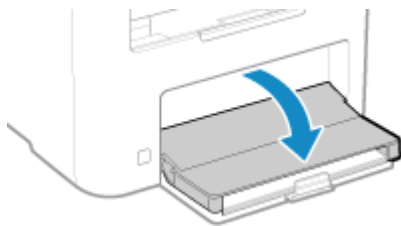

## 7 Raise the paper stopper.

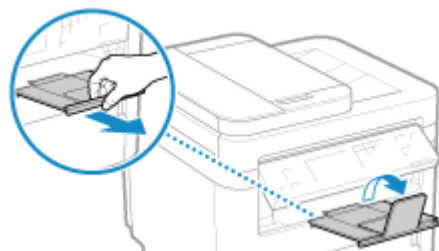

## 8 Set the paper size and type. ▶Setting the Paper Size and Type for the Paper Drawer(P. 140)

By default, the paper size and type of the paper drawer are set to A4 and Plain 2. When paper of a different size or type is loaded, change the paper settings.

# Preparations and Orientation for Loading Envelopes

94WS-030

As envelopes have a different shape and thickness from regular paper, preparations must be made before loading envelopes.

Envelopes can be printed only on the front side (non-glued side). When loading envelopes, pay attention to the orientation and which side is face up.

▶ **Preparations before Loading Envelopes(P. 135)**

▶ **Orientation of Envelopes(P. 136)**

## NOTE

- For the general procedure of loading envelopes, see the following:  
▶ **Loading Paper in the Paper Drawer(P. 133)**

## Preparations before Loading Envelopes

Align the envelopes regardless of the number of envelopes to be loaded.

### 1 Close the flap of each envelope.



### 2 Flatten them to remove any air, and make sure the edges are pressed tightly.



### 3 Loosen any stiff corners of the envelopes, and flatten any curls.

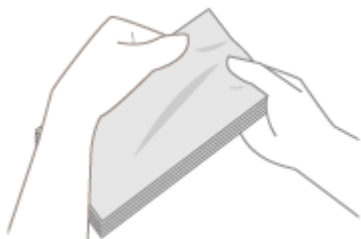

### 4 Align the edges of the envelopes on a flat surface.



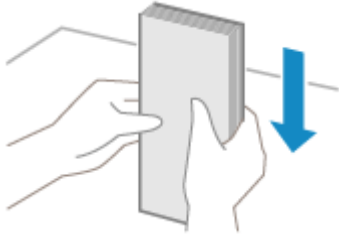

⇒ The envelopes are ready to be loaded.

## Orientation of Envelopes

Load the envelopes No. 10 (COM10), Monarch, ISO-C5, or DL in portrait orientation with the front side (non-glued side) face up and the long side of the envelope parallel with the long side of the paper drawer. Load the envelope with the flap closed and on the left side.

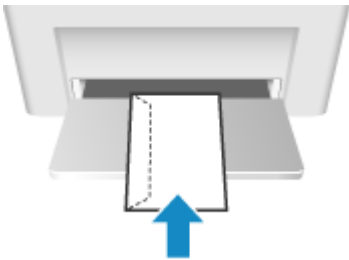

## Orientation for Loading Paper with a Logo

94WS-031

When loading paper with a logo, pay attention to the orientation and which side is face up. By default, the orientation the paper is to be loaded and the side to print on vary depending on whether you want to print on one or both sides.

▶ **Printing on One Side of Paper with a Logo(P. 137)**

▶ **Printing on Both Sides of Paper with a Logo(P. 137)**

### NOTE

- For the general procedure of loading paper, see the following:
  - ▶ **Loading Paper in the Paper Drawer(P. 133)**
- You can configure the settings so that the orientation the paper is to be loaded and the side to print on do not change depending on whether you want to print on one or both sides. When this setting is configured, load the paper using the 2-sided printing method. ▶ **[Switch Paper Feed Method](P. 416)**

### Printing on One Side of Paper with a Logo

Load the paper with the logo side (side to be printed) face up.

#### Paper with logo in portrait orientation

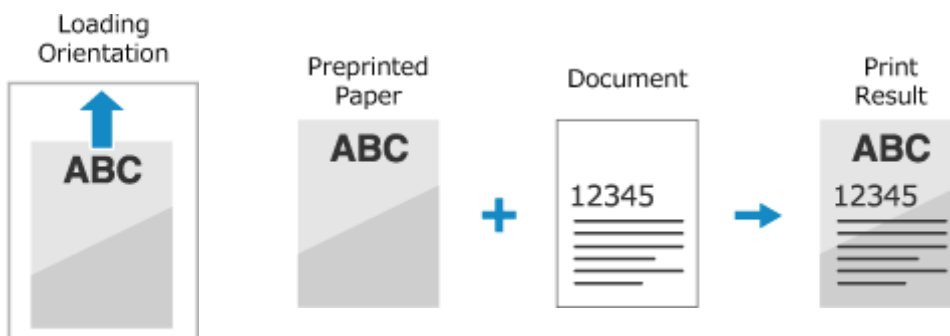

#### Paper with logo in landscape orientation

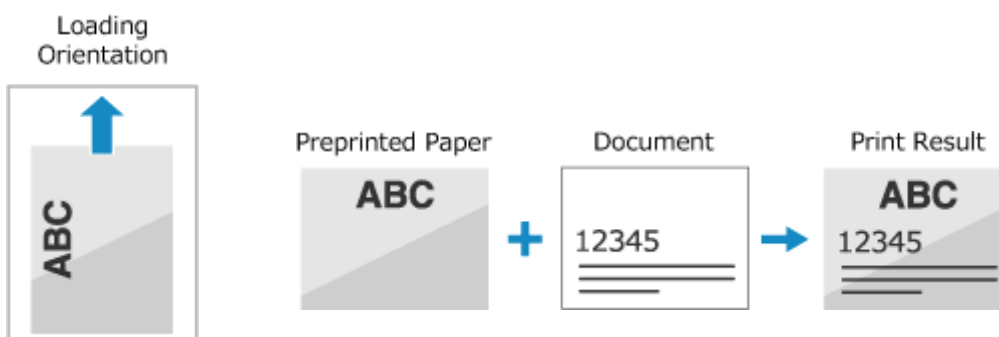

### Printing on Both Sides of Paper with a Logo

Load the paper with the logo side (side to be printed first) face down.

#### Paper with logo in portrait orientation



**Paper with logo in landscape orientation**



## Specifying the Paper Size and Type

---

94WS-032

To ensure quality printing and prevent paper jams, the paper size and type must be set correctly according to the loaded paper.

You can register frequently used paper settings and hide unneeded paper settings to simplify the paper settings.

### **Settings Required after Loading the Paper**

Set the paper size and type according to the loaded paper.

▶ **Setting the Paper Size and Type for the Paper Drawer(P. 140)**

### **Simplifying the Paper Settings**

You can register and set the paper size for easier settings.

▶ **Registering Non-standard Size Paper (Custom Paper)(P. 143)**

▶ **Hiding Unused Paper Sizes(P. 145)**

# Setting the Paper Size and Type for the Paper Drawer

94WS-033

By default, the paper size and type of the paper drawer are set to A4 and Plain 2. When paper of a different size or type is loaded, change the paper settings.

This section describes how to configure the settings using the operation panel.

You can also configure the settings using Remote UI from a computer. [▶Managing the Machine from a Computer \(Remote UI\)\(P. 348\)](#)

[▶Touch Panel Model\(P. 140\)](#)

[▶5 Lines LCD Model\(P. 141\)](#)

## Touch Panel Model

**1** On the operation panel, press [Paper Set.] in the [Home] screen. [▶\[Home\] Screen\(P. 113\)](#)

**2** Press [Drawer 1].

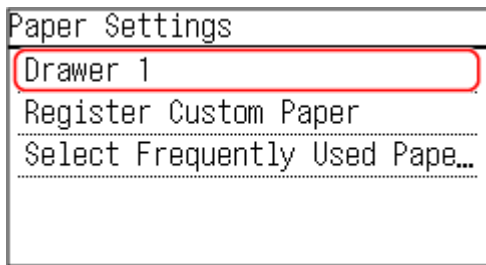

**3** Select the size of the paper loaded in the paper drawer.

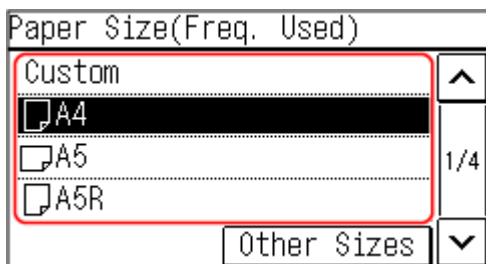

You can scroll the screen to view paper sizes (such as envelopes) not displayed on the screen.

### ■When A5 Size Paper Is Loaded

When paper is loaded in the landscape orientation, select [A5]. When paper is loaded in the portrait orientation, select [A5R].

Landscape orientation (A5)



Portrait orientation (A5R)

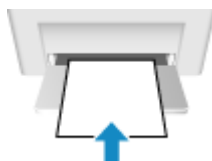

### ■When Non-standard Size (Custom Size) Paper Is Loaded

- 1 Press [Custom].
- 2 Press [X] ► enter the value in [X] ► press [Apply].

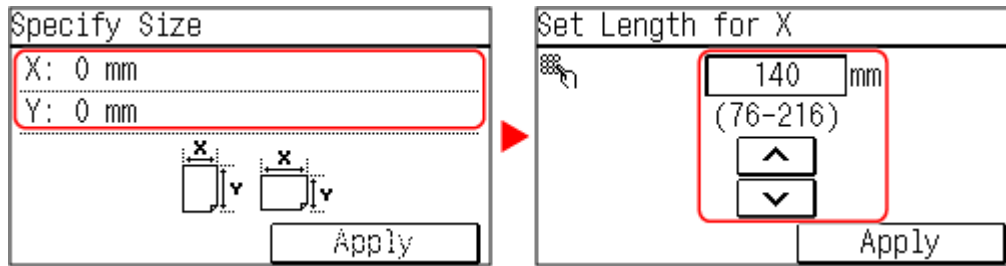

- 3 Enter the value in [Y] in the same way as [X].
- 4 Press [Apply].
- 5 Press [Apply].

### ■If a Set Paper Size Is Not Displayed

Press [Other Sizes], and select the paper size from the displayed list.

## 4 Select the type of the paper loaded in the paper drawer.

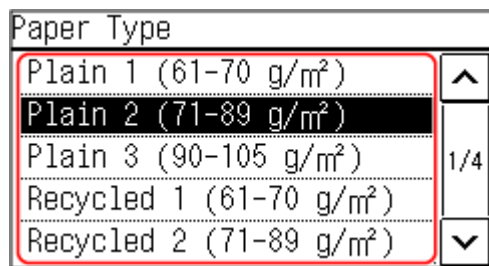

⇒ The paper size and type are set.

## NOTE

- You can change the paper size displayed on the screen in Step 3. ◀ **Hiding Unused Paper Sizes(P. 145)**

## 5 Lines LCD Model

- 1 On the operation panel, select [Paper Settings] in the [Home] screen, and press **OK**. ▶ **[Home] Screen(P. 113)**
- 2 Press [Drawer 1], and press **OK**.

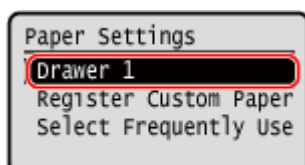

### 3 Select the size of the paper loaded in the paper drawer, and press **OK**.

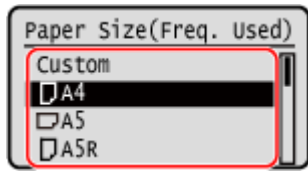

You can scroll the screen to view paper sizes (such as envelopes) not displayed on the screen.

#### ■ When A5 Size Paper Is Loaded

When paper is loaded in the landscape orientation, select [A5]. When paper is loaded in the portrait orientation, select [A5R].

Landscape orientation (A5)



Portrait orientation (A5R)

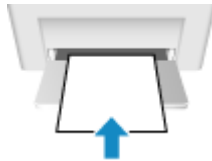

#### ■ When Non-standard Size (Custom Size) Paper Is Loaded

- 1 Press [Custom].
- 2 Press [X] ► **OK** ► enter the value in [X] ► **OK**.

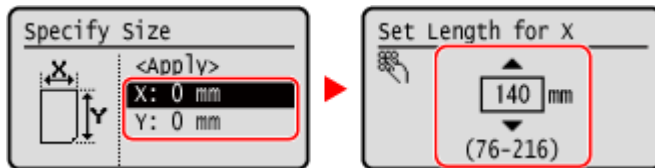

- 3 Enter the value in [Y] in the same way as [X].
- 4 Select [<Apply>], and press **OK**.

#### ■ If a Set Paper Size Is Not Displayed

Press [<Other Sizes>], press **OK**, and select the paper size from the displayed list.

### 4 Select the type of the paper loaded in the paper drawer, and press **OK**.

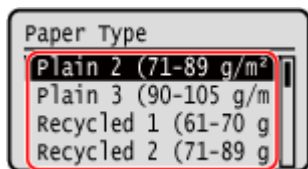

## NOTE

- You can change the paper size displayed on the screen in Step 3. [▶ Hiding Unused Paper Sizes\(P. 145\)](#)

## Registering Non-standard Size Paper (Custom Paper)

94WS-036

Custom paper is non-standard size paper whose side lengths can be freely defined within the range supported by the machine.

You can register sizes when frequently using specific non-standard size paper. You can call up the paper on the size input screen, saving you the trouble of entering the size.

You can register up to three custom sizes.

This section describes how to register the settings using the operation panel.

You can also register the settings using Remote UI from a computer. [▶Managing the Machine from a Computer \(Remote UI\)\(P. 348\)](#)

[▶Touch Panel Model\(P. 143\)](#)

[▶5 Lines LCD Model\(P. 144\)](#)

### Touch Panel Model

**1** On the operation panel, press [Paper Set.] in the [Home] screen. [▶\[Home\] Screen\(P. 113\)](#)

**2** Press [Register Custom Paper].

⇒ The [Register Custom Paper] screen is displayed.

**3** Select the registration number.

If you have selected the registered number, continue on to select [Edit].

**4** Press [x] ▶ enter the value in [x] ▶ press [Apply].

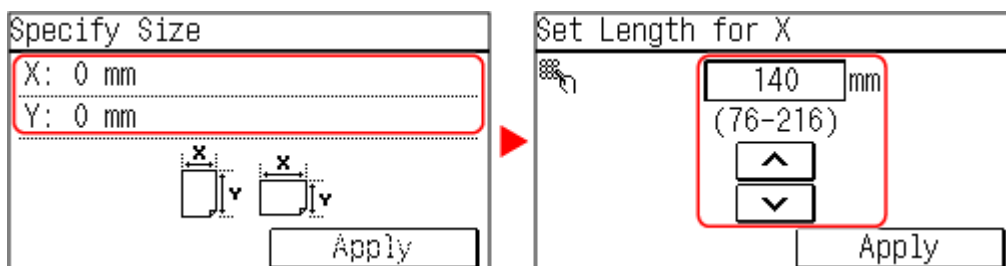

**5** Enter the value in [y] in the same way as [x].

**6** Press [Apply].

**7** Select the type of the paper.



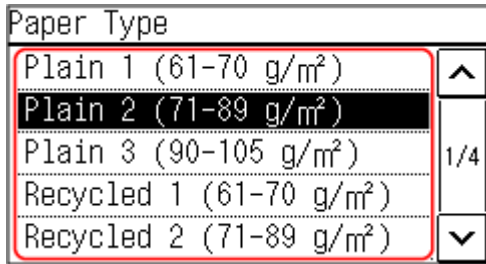

⇒ The custom paper is registered.

## 5 Lines LCD Model

**1** On the operation panel, select [Paper Settings] in the [Home] screen, and press **OK**.  **[Home] Screen(P. 113)**

**2** Select [Register Custom Paper], and press **OK**.

⇒ The [Register Custom Paper] screen is displayed.

**3** Select the registration number, and press **OK**.

If you have selected the registered number, continue on to select [Edit], and press **OK**.

**4** Press [x] ► **OK** ► enter the value in [x] ► **OK**.

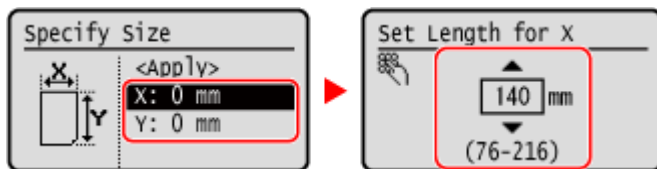

Enter the value using ▲ and ▼.

**5** Enter the value in [y] in the same way as [x].

**6** Select [<Apply>], and press **OK**.

**7** Select the type of the paper, and press **OK**.

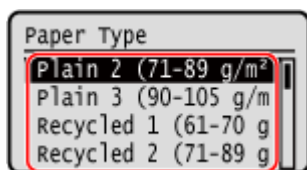

⇒ The custom paper is registered.

## Hiding Unused Paper Sizes

The paper settings screen displays the registered frequently used paper sizes. If unused paper sizes are displayed, you can hide these to make it easier to select a paper size.

To select a hidden paper size, press [Other Sizes] on the paper settings screen.

Use the operation panel to configure the settings. You cannot configure the settings using Remote UI from a computer.

▶ **Touch Panel Model(P. 145)**

▶ **5 Lines LCD Model(P. 145)**

### Touch Panel Model

**1** On the operation panel, press [Paper Set.] in the [Home] screen. ▶ [Home] Screen(P. 113)

**2** Press [Select Frequently Used Paper Sizes].

⇒ The [Frequently Used Sizes] screen is displayed.

**3** Press [Drawer 1].

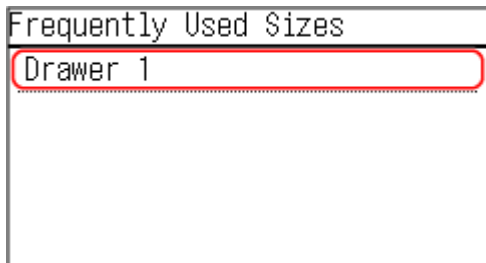

**4** Clear the checkboxes of the paper sizes to hide, and press [Apply].

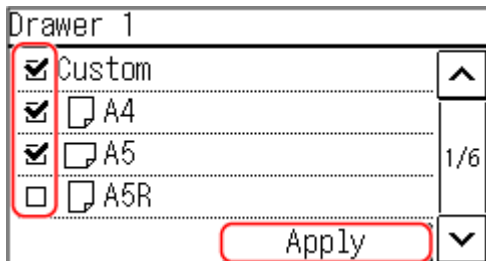

⇒ Paper sizes whose checkboxes are cleared are not displayed on the paper settings screen.

### 5 Lines LCD Model

**1** On the operation panel, select [Paper Settings] in the [Home] screen, and press **OK**. ▶ [Home] Screen(P. 113)

**2 Select [Select Frequently Used Paper Sizes], and press **OK**.**

⇒ The [Frequently Used Sizes] screen is displayed.

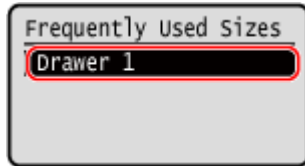
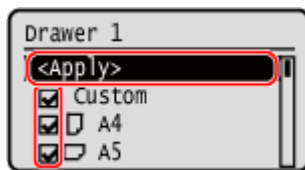
**3 Select [Drawer 1], and press **OK**.****4 Clear the checkboxes of the paper sizes to hide, and press [**<Apply>**] **OK**.**

⇒ Paper sizes whose checkboxes are cleared are not displayed on the paper settings screen.

# Registering Destinations (Address Book) (Touch Panel Model)

---

94WS-039

Register destinations for sending faxes in the machine's Address Book.

## Address Book Function

---

By registering destinations to the Address Book, you can save the trouble of entering the information of destinations each time you send data. The Address Book has a function for easily specifying destinations. Use this function when displaying the Address Book screen or specifying destinations.

🔗 **Address Book Function (Touch Panel Model)(P. 148)**

## Destinations that Can Be Registered

---

- Fax number

## How to Register Destinations

---

You can register a destination by entering a name, fax number, and other information, or by using the TX Job Log.

You can register destinations either with the operation panel or Remote UI, but the types of destinations that can be registered and the registration method vary.

### Registering Using the Operation Panel

Use the operation panel to register destinations from the TX Job Log.

🔗 **Registering Destinations to the Address Book (Operation Panel) (Touch Panel Model)(P. 150)**

### Registering Using Remote UI

You cannot use Remote UI to register destinations from the TX Job Log.

🔗 **Registering Destinations to the Address Book (Remote UI) (Touch Panel Model)(P. 155)**

## ■ See Also

### Preventing Unauthorized Use of the Address Book

To prevent unauthorized adding of new entries to the Address Book and editing of existing entries, you can set a PIN and restrict the method for adding new entries.

🔗 **Restricting Address Book Registration and Editing (Touch Panel Model)(P. 335)**

## Address Book Function (Touch Panel Model)

94WS-03A

You can specify destinations registered in the Address Book by calling up the Address Book in the [Home] screen or the fax screen on the operation panel.

When registering destinations, select the function to quickly specify the destination.

You can also efficiently specify destinations from the Address Book screen, such as by grouping destinations or displaying them by type.

### Function to Quickly Specify a Destination

When registering destinations, select and register either of the following:

- **One-Touch Dial**

Register frequently used destinations in One-Touch Dial. This will display registered destinations as one-touch buttons in the [Home] screen. You can register up to four One-Touch Dial destinations.

- **Coded Dial**

Register a 3-digit number for each destination. You can then directly enter that number to specify a destination.

You can register up to 100 destinations with Coded Dial numbers.

### Registering a Group of Multiple Destinations

You can register multiple registered fax number destinations as a group to Coded Dial. This saves you the trouble of specifying multiple destinations individually when sending data. You can register up to 50 groups. You can register only the same type of destinations for one group.

▶ **Registering Groups to the Address Book (Operation Panel) (Touch Panel Model)(P. 152)**

▶ **Registering Groups to the Address Book (Remote UI) (Touch Panel Model)(P. 157)**

### Classifying by Index

You can display the initials of the names and types of destinations (such as fax) set at the time of registration by classifying them by index.

## ■ Address Book Screen

When you call the Address Book from the [Home] screen or fax screen, the following screen is displayed.

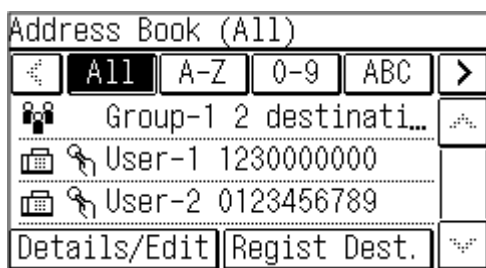

### List of Registered Destinations



The types of destinations are indicated with the following symbols, and the destination information, such as the name, and fax number, are displayed:

[]: Fax

[]: Group destinations

### Index

This is displayed at the top of the screen. You can filter destinations displayed in the list by selecting their type or the initials of a name.

- Tap [] or [] to change the index display.
- To display all destinations registered to the Address Book, select [All].
- When specifying the destinations to be displayed by initials of the name, select [A-Z], [0-9], or [ABC] to [YZ].

### Destination Operation Items

These are displayed on the bottom of the screen. Press to register, edit, or delete a destination, or to specify a destination to which to send data.

## Basic Operations

- For items other than [Regist Dest.], select the checkbox of a destination, and then perform the operation.
- When you call the Address Book from the [Home] screen, press the destination to display the fax screen with the specified destination entered.

# Registering Destinations to the Address Book (Operation Panel) (Touch Panel Model)

94WS-03C

You can register destinations to the Address Book by directly entering their information using the operation panel.

**1** On the operation panel, press [Addr. Book] in the [Home] screen.  [Home] Screen(P. 113)

**2** Press [Regist Dest.].

⇒ The [Register As] screen is displayed.

If the [Address Book PIN] screen is displayed, enter the PIN, and press [Apply].

**3** Press [Coded Dial] or [One-Touch], and press [Fax].

- If [Coded Dial] is selected, unregistered coded dialing numbers are automatically set and the [Fax] screen is displayed.
- When [One-Touch] is selected, select the number to register. You can change this number to another number later.
- When registering group destinations, see the following.
  - ▶ **Registering Groups to the Address Book (Operation Panel) (Touch Panel Model)(P. 152)**

**4** Enter the destination information.

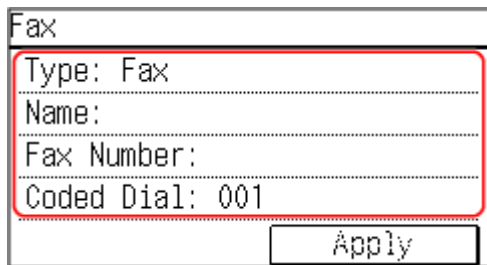

- You can register a destination without entering its name, but by entering the name, you can search for it by its initials when specifying the destination.
- Press [Name:] and enter the name, and then press [Apply].
- For destination information, press [Fax Number:], enter that information, and then press [Apply].
- When entering an international destination in [Fax Number:], enter the international access number, country code, and fax number in that order. If you are unable to connect, press [Pause] in between the numbers to add a pause. You can change the pause time.  **[Set Pause Time](P. 436)**
- To change a [Coded Dial] number, press [Coded Dial] and enter a three-digit coded dialing number using the numeric keys.

**5** Set the fax sending details, as needed.

Set the details when a send error occurs or it takes time to send a fax to that number.

- 1 Press [Fax Number:] ► [Details].
- 2 Set the items, and press [Apply].

**[ECM TX] \*1**

When an error occurs for an image being sent, the machine corrects the image so as not to send a distorted image.

**[TX Speed] \*1**

If it takes time to start sending a fax, such as when there is a poor phone line connection, the machine lowers the communication start speed.

**[Long Distance]**

If a communication error occurs when sending a fax to an international destination, select [International (1)]. If the error does not improve, select [International (2)] and [International (3)] in that order.

\*1 If this is not set here, the settings that appear when selecting [Menu] in the [Home] screen and then selecting [Function Settings] are applied.

🔴 **[ECM TX](P. 435)**

🔴 **[TX Start Speed](P. 437)**

- 3 Press [Apply].

## 6 Press [Apply].

⇒ The destination is registered to the Address Book.

## NOTE

### Registering a Destination from the TX Job Log of a Fax Job

- In addition to calling up the TX Job Log from the Address Book, you can also register destinations from the TX Job Log of a fax job to the Address Book.

🔴 **Checking the Status and Log for Sent and Received Faxes(P. 236)**



# Registering Groups to the Address Book (Operation Panel) (Touch Panel Model)

94WS-03E

You can register a group of multiple destinations to the Address Book using the operation panel. You can register only the same type of destinations for a group.

## Required Preparations

- Register the destinations to be added to a group to the Address Book of the machine. [▶ Registering Destinations to the Address Book \(Operation Panel\) \(Touch Panel Model\)\(P. 150\)](#)

**1 On the operation panel, press [Addr. Book] in the [Home] screen. [▶ \[Home\] Screen\(P. 113\)](#)**

**2 Press [Regist Dest.].**

⇒ The [Register As] screen is displayed.

- If the [Address Book PIN] screen is displayed, enter the PIN, and press [Apply].
- Select the index at the top of the screen of the Address Book to filter and display the destinations.

**3 Press [Coded Dial] or [One-Touch], and press [Group].**

⇒ The [Group] screen is displayed.

- If [Coded Dial] is selected, unregistered coded dialing numbers are automatically set and the [Group] screen is displayed.
- When [One-Touch] is selected, select the number to register. You can change this number to another number later.

**4 Press [Name:] and enter the name, and then press [Apply].**

You can register a destination without entering its name, but by entering the name, you can search for it by its initials when specifying the destination.



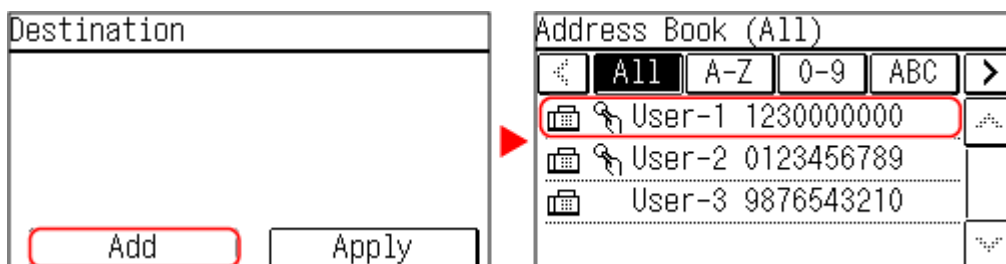

**5 Press [Number of Destinations].**

**6 Press [Add], and select the destinations to add to the group.**



Repeat this step to add multiple destinations.

**7 Check that the destinations to be added to the group are correct, and then press [Apply].**

Destination	
 	User-1 1230000000
 	User-2 0123456789

To view the information of a destination, select the target destination.

**8 Change registered numbers as needed.**

To change a [Coded Dial] number, press [Coded Dial] and select an unregistered number, or enter a three-digit coded dialing number using the numeric keys.

**9 Press [Apply].**

⇒ The group is registered to the Address Book.

# Editing and Deleting Destinations in the Address Book (Operation Panel) (Touch Panel Model)

94WS-03F

You can edit information of destinations registered in the Address Book or delete unused destinations.

- 1** On the operation panel, press [Addr. Book] in the [Home] screen.  [Home] Screen(P. 113)
- 2** Press [Details/Edit], and select the destination to edit or delete.

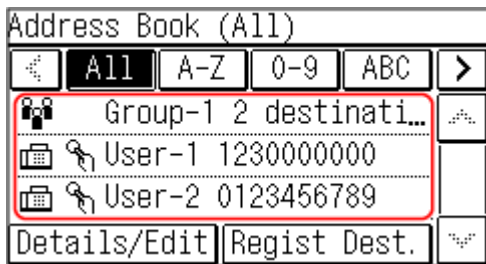

- Select the index at the top of the screen of the Address Book to filter and display the destinations.

## 3 Edit or delete the destination.

### ■ When Editing a Destination

- 1** Press [Edit].  
If the [Address Book PIN] screen is displayed, enter the PIN, and press [Apply].
- 2** Edit the item, and press [Apply].  
⇒ The edited information is applied.

### ■ When Deleting a Destination

- 1** Press [Delete].  
If the [Address Book PIN] screen is displayed, enter the PIN, and press [Apply].
- 2** Press [Yes].  
⇒ The destination is deleted.

## Registering Destinations to the Address Book (Remote UI) (Touch Panel Model)

94WS-03H

You can register destinations to the Address Book using Remote UI from a computer.

Administrator privileges are required to register destinations using Remote UI.

- 1 Log in to Remote UI in System Manager Mode. ▶ Starting Remote UI(P. 349)
- 2 On the Portal page of Remote UI, click [Address Book]. ▶ Portal Page of Remote UI(P. 351)
- 3 Click [One-Touch] or [Coded Dial].
- 4 Click an item displayed as [Not Registered].

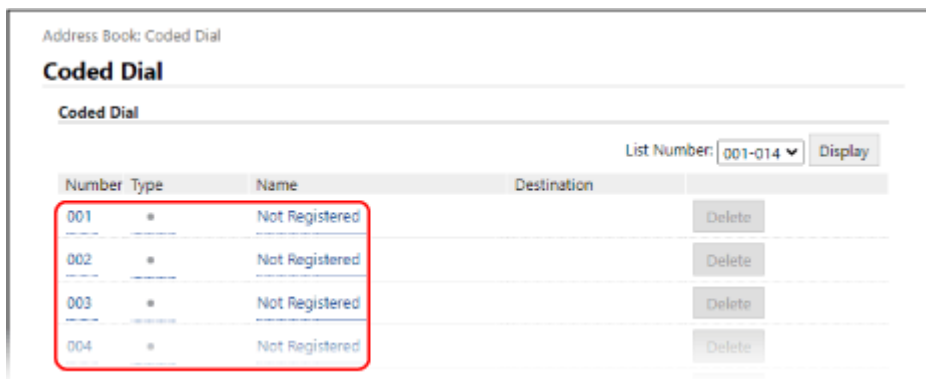

⇒ The [Register New Destination] screen is displayed.

If the [Enter PIN] screen is displayed, enter the Address Book PIN, and then click [OK].

- 5 Select [Fax], and click [OK].

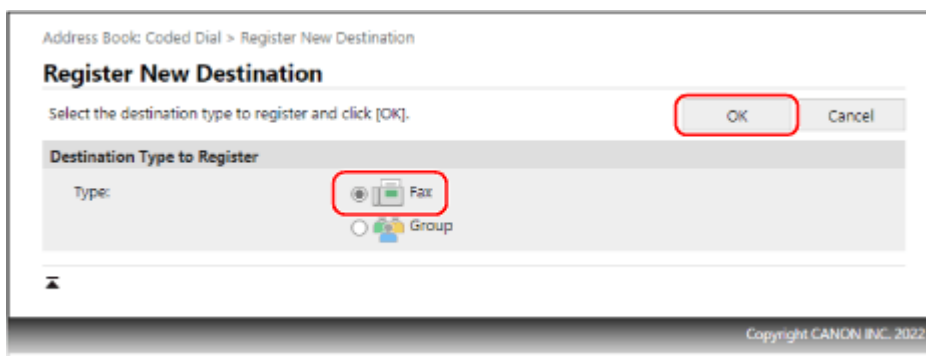

When registering group destinations, see the following.

- ▶ Registering Groups to the Address Book (Remote UI) (Touch Panel Model)(P. 157)

## 6 Set the destination information.

You can register a destination without entering its name, but by entering the name, you can search for it by its initials when specifying the destination.

1 Enter the name and fax number.

2 Set the fax sending details, as needed.

If a send error occurs or it takes time to send a fax to a registered fax number, set the fax sending details.

### [ECM TX] \*1

When this is selected and an error occurs for an image being sent, the machine corrects the image so as not to send a distorted image.

### [Speed] \*1

If it takes time to start sending a fax, such as when there is a poor phone line connection, the machine lowers the communication start speed.

### [Long Distance]

If a communication error occurs when sending a fax to an international destination, select [International (1)]. If the error does not improve, select [International (2)] and [International (3)] in that order.

\*1 If this is not set here, the setting in [Settings/Registration] ► [TX Settings] ► [Fax TX Settings] is applied.

🔍 [ECM TX](P. 435)

🔍 [TX Start Speed](P. 437)

## 7 Click [OK].

⇒ The destination is registered to the Address Book.

## 8 Log out from Remote UI.

## NOTE

### Editing or Deleting Registered Destinations

- You can edit the registered information by clicking the destination you want to edit in the screen in Step 4.
- In Step 4, click [Delete] to the right of the destination you want to delete, and the destination will be deleted.

## Registering Groups to the Address Book (Remote UI) (Touch Panel Model)

94WS-03J

You can register a group of multiple destinations to the Address Book using Remote UI from a computer. You can register only the same type of destinations for a group.

Administrator privileges are required to register a group using Remote UI.

### Required Preparations

- Register the destinations to be added to a group to the Address Book of the machine. [▶Registering Destinations to the Address Book \(Remote UI\) \(Touch Panel Model\)\(P. 155\)](#)

- 1 Log in to Remote UI in System Manager Mode.** [▶Starting Remote UI\(P. 349\)](#)
- 2 On the Portal page of Remote UI, click [Address Book].** [▶Portal Page of Remote UI\(P. 351\)](#)
- 3 Click [One-Touch] or [Coded Dial].**
- 4 Click an item displayed as [Not Registered].**

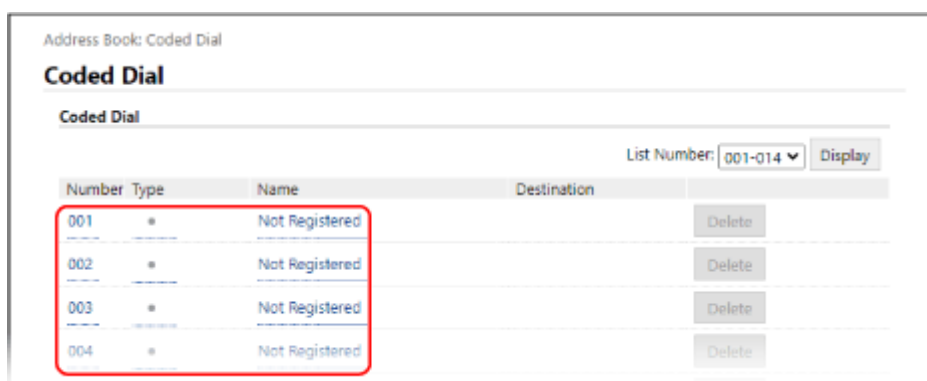

⇒ The [Register New Destination] screen is displayed.

If the [Enter PIN] screen is displayed, enter the Address Book PIN, and then click [OK].

- 5 Select [Group], and click [OK].**

⇒ The [Register New Destination: Group] screen is displayed.

- 6 In [Group], enter the group name.**

You can register a group without entering its name, but by entering the name, you can search for it by its initials when specifying the destination.

**7** In [Member Settings], click [Select from Address Book].

**8** Change the display of the Address Book, as needed.

In [Type], select [One-Touch] or [Coded Dial], and click [Display] to change the display of the Address Book.

**9** Select the checkboxes of the destinations to add to the group, and click [OK].

⇒ The destinations are added to [Member List] on the [Register New Destination: Group] screen.

You can select multiple destinations at the same time.

**10** Click [OK].

⇒ The group is registered to the Address Book.

**11** Log out from Remote UI.

## Specifying Destinations (Touch Panel Model)

---

94WS-03K

When sending faxes, specify destinations using the method below.

### Specifying Destinations

---

#### Using the Address Book

Specify a destination registered to the Address Book of the machine.

➤ **Specifying Destinations (Address Book) (Touch Panel Model)(P. 160)**

#### Directly Entering a Destination

Enter the destination using the keyboard or numeric keys on the operation panel.

➤ **Specifying Destinations (Direct Input) (Touch Panel Model)(P. 162)**

#### Using the TX Job Log

You can call up the TX Job Log of fax jobs and specify destinations that were specified in the past.

➤ **Specifying Destinations (TX Job Log) (Touch Panel Model)(P. 163)**

### Specifying Multiple Destinations

---

You can specify multiple destinations by repeating the operation of specifying a destination.

#### When Removing a Specific Destination after Specifying Multiple Destinations

Use the following procedure:

On the fax screen, press [Destination] ► [Confirm/Edit] ► select the destination or group to remove ► [Remove] ► [Yes].

If you selected a group, you can press [Number of Destinations:] to view the destinations registered to that group. You cannot individually remove destinations registered to a group.

### Confirming Destinations

---

The screen for confirming whether a specified destination is correct may be displayed depending on the settings of the machine.

In addition, the method for specifying destinations may be restricted, and sending may be restricted to only specific destinations.

➤ **Preventing Sending Data by Mistake and Leaking Information(P. 323)**



# Specifying Destinations (Address Book) (Touch Panel Model)

94WS-03L

When specifying destinations with the Address Book, use the [Home] screen or the fax screen on the operation panel. When specifying destinations by calling up the Address Book from the [Home] screen, use the destination list. When specifying destinations on the fax screen, in addition to using the destination list, you can also enter the Coded Dial number to specify a destination.

- ▶ **Specifying Destinations from a List(P. 160)**
- ▶ **Specifying Destinations with Coded Dial Numbers(P. 160)**

## Specifying Destinations from a List

### 1 On the operation panel, press [Addr. Book] in the [Home] screen. ▶[Home] Screen(P. 113)

⇒ The Address Book is displayed.

For the fax screen, press [Destination] ▶ [Specify from Address Book].

### 2 Select the destinations to specify.

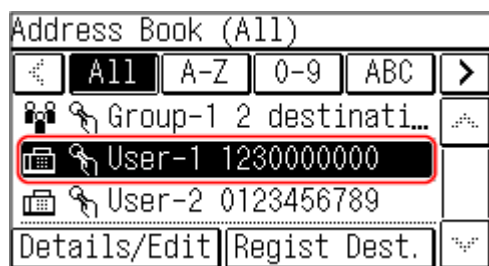

⇒ The destinations are specified.

When destinations are specified by calling up the Address Book from the [Home] screen, the fax screen is displayed with the specified destinations entered.

Select the index at the top of the screen of the Address Book to filter and display the destinations.

## Specifying Destinations with Coded Dial Numbers

You can enter a three-digit Coded Dial number to specify a destination.

### 1 On the operation panel, press [Coded Dial] in the [Home] screen. ▶[Home] Screen(P. 113)

⇒ The [Enter Coded Dial No.] screen is displayed.

For the fax screen, press [Destination] ▶ [Specify from Coded Dial].

### 2 Enter a three-digit Coded Dial number.

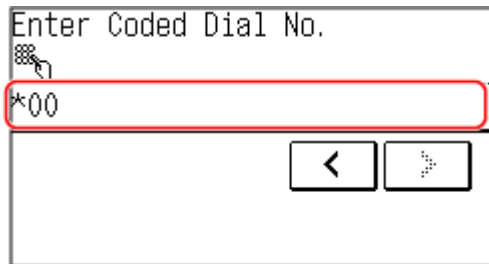

Enter Coded Dial No.

\*00

< >

The image shows a rectangular window with a title bar. Inside the window, the text 'Enter Coded Dial No.' is at the top. Below it is a text input field containing the characters '\*00'. The input field is highlighted with a red border. At the bottom right of the window, there are two square buttons: the left one contains a left-pointing arrow (<) and the right one contains a right-pointing arrow (>).

⇒ The destination is specified.

If you entered an incorrect number, press [ **C** ] to clear the numbers.

## Specifying Destinations (Direct Input) (Touch Panel Model)

---

94WS-03R

To specify a destination not registered to the Address Book, directly enter the destination using the fax screen of the operation panel.

On the fax screen, enter a fax number.

- If the machine is connected via Private Branch Exchange (PBX), press [R] before entering the destination with the numeric keys. If [R] is not available, you must register the R-key setting. ▶**[R-Key Setting](P. 438)**
- If you entered an incorrect fax number, press [C] to clear the number.
- To enter a second and subsequent destinations, press [Destination] and select the method for specifying destinations.
- When sending a fax to an international destination, enter the international access number, country code, and fax number in that order. If you are unable to connect, press [Pause] in between the numbers to add a pause. You can change the pause time. ▶**[Set Pause Time](P. 436)**

# Specifying Destinations (TX Job Log) (Touch Panel Model)

94WS-03W

You can specify destinations used in the past by calling up the TX Job Log from the fax screen of the operation panel. You can also apply the scan settings used to send data together with the destinations. When you call up the TX Job Log, the specified destinations and scan settings are overwritten.

## ! IMPORTANT

- You cannot use the TX Job Log when sending from the log is restricted. **▶ Prohibiting the Use of Destinations in the Send Log(P. 324)**

**1** On the fax screen, press [Destination] ▶ [Recall Set.].

**2** Select the log you want to call up.

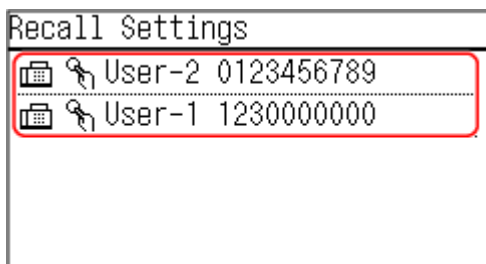

⇒ The destinations are specified.

When there are multiple destinations in the log, only the first destination is displayed, but all of the destinations are applied.

**3** Change the destinations and scan settings, as needed.

You can change and send the called up destinations and scan settings.

## NOTE

- The TX Job Log is cleared in the following cases:
  - When the power is turned OFF
  - When entry of new destinations is restricted **▶ Sending Only to Registered Destinations(P. 325)**

## To change the default settings

---

94WS-0J6

If you often use the same settings and values for the fax and copy functions, you can change the default settings. If you do not change the settings, the default settings will be used unchanged.

By configuring the settings as the preferred standard or to save paper, for example, you can increase work efficiency and reduce costs.

🔗 **Changing the Default Settings(P. 165)**

# Changing the Default Settings

You can change the default settings for copy and fax functions called up using the operation panel. You can also reset the settings to the settings set here by pressing  on the copy or fax function screen.

This section describes how to configure the settings using the operation panel. You can also configure the settings using Remote UI from a computer. [▶Managing the Machine from a Computer \(Remote UI\)\(P. 348\)](#)

[▶Touch Panel Model\(P. 165\)](#)

[▶5 Lines LCD Model\(P. 166\)](#)

## Touch Panel Model

**1** On the operation panel, press [Menu] in the [Home] screen. [▶\[Home\] Screen\(P. 113\)](#)

**2** Press [Function Settings].

**3** Select the default setting item you want to change.

Select from the following items according to the function you want to change.

### Fax

[Send] ▶ [Fax Settings] ▶ [Change Default Settings]

### Copy

[Copy] ▶ [Change Default Settings]

**4** Select the setting items to change, and change the default settings.

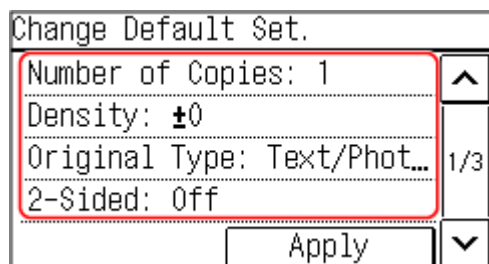

For details about the setting items of each function, see the following:

- Fax: [▶\[Change Default Settings\]\(P. 435\)](#)
- Copy: [▶\[Change Default Settings\]\(P. 420\)](#)

**5** Press [Apply].

⇒ The default settings are changed.

## NOTE

## Restoring Default Settings to the Factory Settings

### For faxing

- On the screen in Step 4, press [Initialize] ▶ [Yes].

### For copying

- In step 3 of [Copy Settings], press [Initialize Default Settings] ▶ [Yes].

## 5 Lines LCD Model

- On the operation panel, select [Menu] in the [Home] screen, and press **OK**. ▶ [Home] Screen(P. 113)
- Press [Function Settings] ▶ **OK** ▶ [Copy] ▶ **OK** ▶ [Change Default Settings] ▶ **OK**.
- Select the setting items to change, press **OK**, and change the default settings.

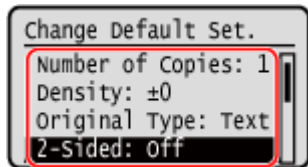

For details about the setting items, see the following:

- ▶ [Change Default Settings](P. 420)

- Select [<Apply>], and press **OK**.

⇒ The default settings are changed.

## NOTE

### Restoring Default Settings to the Factory Settings

- In step 2 of [Copy Settings], press [Initialize Default Settings] ▶ **OK** ▶ [Yes] ▶ **OK**.

## Adjusting the Sound Volume (Touch Panel Model)

---

94WS-042

You can adjust the volume of the sounds emitted by the machine and set whether the machine emits sounds notifying you of operations and statuses.

▶ **Adjusting the Volume (Touch Panel Model)(P. 168)**



# Adjusting the Volume (Touch Panel Model)

94WS-043

You can adjust the volume of sounds emitted by the machine.  
You can also set whether the machine emits sounds notifying you of operations and statuses.

- ▶ **Adjusting the Fax Volume(P. 168)**
- ▶ **Adjusting Other Fax Function Sounds(P. 168)**
- ▶ **Setting the Notification Sounds for Operations and Statuses(P. 169)**

## Adjusting the Fax Volume

You can adjust the volume of the tone emitted when sending and receiving faxes.

This section describes how to adjust the volume using the operation panel.  
You can also adjust the volume using Remote UI from a computer. ▶ **Managing the Machine from a Computer (Remote UI)(P. 348)**

- 1 On the operation panel, select [Menu] in the [Home] screen. ▶ [Home] Screen(P. 113)**
- 2 Press [Preferences] ▶ [Volume Settings].**
  - ⇒ The [Volume Settings] screen is displayed.
- 3 Press [Fax Tone].**
- 4 Move the slider to the left or right to adjust the volume, and press [Apply].**

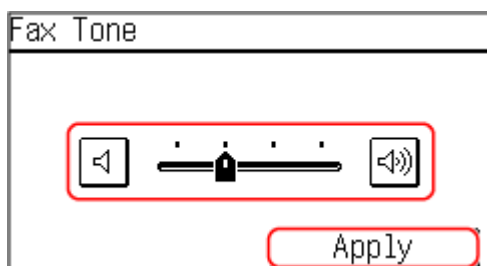

- ⇒ The volume is adjusted.
- Moving the slider to the right increases the volume.
- Moving the slider to the far left mutes the sound.

## Adjusting Other Fax Function Sounds

You can adjust the volume of the incoming fax sound and the sounds notifying you when faxes are successfully sent and received, and when originals are successfully scanned.  
You can also configure the [TX Done Tone], [RX Done Tone], and [Scanning Done Tone] settings to emit a sound only when an error occurs.

This section describes how to adjust the volume using the operation panel.

You can also adjust the volume using Remote UI from a computer. [▶Managing the Machine from a Computer \(Remote UI\)\(P. 348\)](#)

**1** On the operation panel, select [Menu] in the [Home] screen. [▶\[Home\] Screen\(P. 113\)](#)

**2** Press [Preferences] ▶ [Volume Settings].

⇒ The [Volume Settings] screen is displayed.

**3** Select the item whose volume you want to adjust.

**[Ring Tone]**

Adjust the volume of the sound notifying you of incoming faxes.

**[TX Done Tone]**

Adjust the volume of the sound notifying you that sending of a fax is complete.

**[RX Done Tone]**

Adjust the volume of the sound notifying you that receiving of a fax is complete.

**[Scanning Done Tone]**

Adjust the volume of the sound notifying you that scanning of a fax original is complete.

**4** Move the slider to the left or right to adjust the volume, and press [Apply].

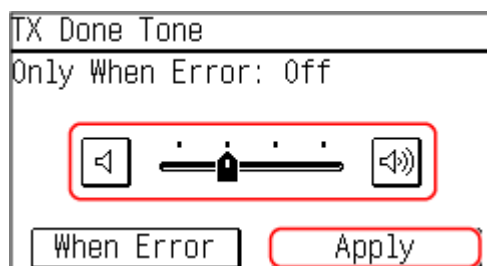

- Moving the slider to the right increases the volume.
- Moving the slider to the far left mutes the sound.
- To emit a completion sound only when an error occurs, press [When Error] ▶ [On].

**5** Press [Apply].

⇒ The volume is adjusted.

## Setting the Notification Sounds for Operations and Statuses

You can also set whether the machine emits sounds notifying you of operations and statuses, such as when operating the operation panel and errors are detected.

This section describes how to configure the settings using the operation panel.

You can also configure the settings using Remote UI from a computer. [▶Managing the Machine from a Computer \(Remote UI\)\(P. 348\)](#)

**1** On the operation panel, select [Menu] in the [Home] screen. [▶\[Home\] Screen\(P. 113\)](#)

**2 Press [Preferences] ▶ [Volume Settings].**

⇒ The [Volume Settings] screen is displayed.

**3 Select the item to be set.**

**4 Set whether notification sounds are emitted. ▶[Volume Settings] Screen (Touch Panel Model)(P. 171)**

To emit notification sounds, select [On].

## [Volume Settings] Screen (Touch Panel Model)

94WS-045

You can set whether the machine emits sounds notifying you of operations and statuses. When you press [Menu] in the [Home] screen ► [Preferences] ► [Volume Settings], the [Volume Settings] screen is displayed.

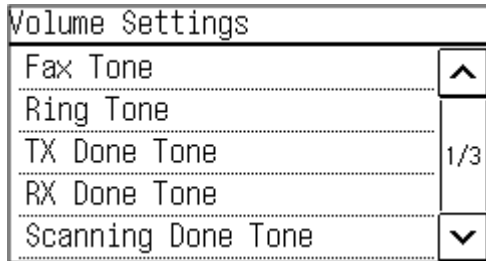

### [Ring Tone], [TX Done Tone], [RX Done Tone], [Scanning Done Tone]

You can adjust the volume of the incoming fax sound and the sounds notifying you when faxes are successfully sent and received, and when originals are successfully scanned.

### [Entry Tone]

Set whether to emit a sound when you press the keys and buttons on the operation panel.

### [Invalid Entry Tone]

Set whether to emit a sound when an invalid key is pressed, such as when you enter a value outside the setting range.

### [Restock Supplies Tone]

Set whether to emit a sound when the toner cartridge is nearing the end of its lifetime.

### [Warning Tone]

Set whether to emit a sound when the machine has a paper jam or other malfunction.

### [Job Done Tone]

Set whether to emit a sound when the copy, scan, or other operation on the machine is completed.

### [Energy Saver Alert]

Set whether to emit a sound when the machine enters and exits sleep mode.

### [Original in Feeder Detection Tone]

Set whether to emit a sound when the machine detects an original that has been placed on the feeder.

# Printing

<b>Printing</b> .....	173
<b>Printing Preparations</b> .....	174
Preparing to Print from a Computer .....	175
Configuring a Printer Port (Windows) .....	176
Setting Up a Print Server .....	179
<b>Printing from a Computer</b> .....	182
Registering Non-standard Size Paper to the Computer (Custom Size) .....	185
<b>Canceling Printing</b> .....	187
<b>Viewing the Print Job Status and Log</b> .....	190

# Printing

---

You can print documents and photos from a computer.

## Printing from a Computer

---

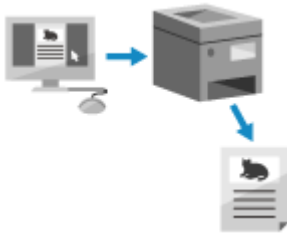

You can print documents and photos via a printer driver installed on a computer connected to the machine.

- ▶ **Preparing to Print from a Computer(P. 175)**
- ▶ **Printing from a Computer(P. 182)**

### Setting Up a Print Server

By setting up a print server on a network, you can reduce the load on the computer that you print from. In Windows, you can install the printer driver via the print server, which saves you the trouble of downloading the printer driver to each computer on the network or using a CD/DVD-ROM.

- ▶ **Setting Up a Print Server(P. 179)**

## Printing with the Standard Functions of the Operating System

---

You can print without having to install a dedicated application or printer driver.

### Windows

This machine is compatible with Universal Print, a cloud service by Microsoft. You can print documents from a remote location as long as your computer is connected to the Internet.

- ▶ **Preparations for Using Universal Print(P. 278)**
- ▶ **Printing with Universal Print(P. 292)**

### macOS

You can use AirPrint to print data. ▶ **Using AirPrint Application to Print and Scan Data and Send Faxes(P. 293)**

### Chrome OS

Use the print function that is standard in the operating system. ▶ **Printing from Chromebook or Other Device with Chrome OS(P. 298)**

## ■ See Also

### Printing from a Mobile Device

The machine can be operated from a smartphone, tablet, or other mobile device. By using a compatible application or service, you can easily print photos or documents from a mobile device.

- ▶ **Linking with Mobile Devices and Integrating with a Cloud Service(P. 273)**

### When Results Are Not as Expected

If print results are too dark or too faint, adjust the print density.

- ▶ **Adjusting the Print Density(P. 480)**

# Printing Preparations

---

94WS-047

To print from the machine, you must make printing preparations according to your printing method and usage environment.

- ▶ **Preparing to Print from a Computer(P. 175)**
- ▶ **Setting Up a Print Server(P. 179)**
- ▶ **Preparations for Using Universal Print(P. 278)**

# Preparing to Print from a Computer

94WS-048

Install the printer driver to the computer that will be used to print. ▶ **Installing Software and Drivers to the Computer(P. 98)**

### Using a Print Server in Windows

Use a print server to install the printer driver.

Double-click the shared printer on the print server, and follow the instructions on the screen to install the printer driver. ▶ **Displaying a Shared Printer in the Print Server(P. 591)**

## NOTE

### Changing the Port Type and Number (Windows)

- If the machine is configured not to use LPD or RAW, or if the port number was changed, the settings on the computer may also have to be changed. ▶ **Changing the Port Type and Number(P. 178)**

### If the IP Address of the Machine Is Changed after Installing the Printer Driver

- In Windows, the required action depends on the port you are using.
  - If you are using an MFNP port, the connection is maintained as long as the machine and computer belong to the same subnet, so no action is required on the computer.
  - If you are using a standard TCP/IP port, you must add a new port. ▶ **Adding a Port(P. 176)**

If you do not know which port is being used, see the following:

▶ **Viewing the Printer Port(P. 596)**

- In macOS, you must re-register the machine on the Mac. For details about registering the machine, see the manual of the driver at the online manual site.

<https://oip.manual.canon/>

\* If you are using DHCP to automatically obtain the IP address of the machine, the IP address may be changed automatically.



## Configuring a Printer Port (Windows)

94WS-049

If the IP address of the machine changed or a printer has been added in Windows, you may not be able to print from a computer. In this case, use the printer driver to add a new port.

In addition, you cannot print from a computer when the port type or port number of the printer driver differ from that of the machine setting. In this case, change the setting on the printer driver to match that of the machine.

▶ **Adding a Port(P. 176)**

▶ **Changing the Port Type and Number(P. 178)**

### Adding a Port

The machine supports two types of ports: "MFNP Port" and "Standard TCP/IP Port." Select and add the port to use according to your usage environment.

#### **MFNP Port (only for IPv4 environment)**

You can only add this port when a printer driver is installed using the installer. The connection is maintained as long as the machine and computer belong to the same subnet, even if the IP address of the machine is changed.

#### **Standard TCP/IP Port**

This is a standard Windows port. You must add a new port every time the IP address of the machine is changed. Select this type of port when you cannot add an MFNP port.

Administrator privileges are required on each computer.

#### Required Preparations

- Prepare the following information and keep it close by. ▶ **Checking the Network Status and Settings(P. 88)**
  - When adding an MFNP port: the IP address or MAC address of the machine
  - When adding a standard TCP/IP port: the IP address or DNS name (host name) of the machine

**1 Log on to the computer using an administrator account.**

**2 Click [Start] (Start) ▶ [Settings] (Settings) ▶ [Devices] ▶ [Printers & scanners].**

⇒ The [Printers & scanners] screen is displayed.

**3 Click the printer driver of the machine ▶ [Manage] ▶ [Printer properties].**

⇒ The printer driver properties screen is displayed.

**4 On the [Ports] tab, click [Add Port].**

⇒ The [Printer Ports] screen is displayed.

**5 Add a new port.**

**■When Adding an MFNP Port**

- 1 Select [Canon MFNP Port], and click [New Port].
- 2 Select [Auto Detect] and the machine, and click [Next].

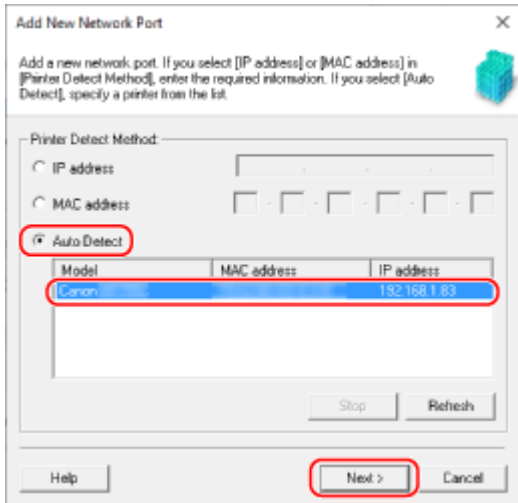

If the machine is not displayed, click [Refresh]. If the machine is still not displayed, select [IP address] or [MAC address], enter the IP address or MAC address of the machine, and then click [Next].

- 3 Click [Add].

**■When Adding a Standard TCP/IP Port**

- 1 Select [Standard TCP/IP Port], and click [New Port].  
 The [Add Standard TCP/IP Printer Port Wizard] screen is displayed.
- 2 Click [Next].
- 3 Enter the IP address or DNS name (host name), and then click [Next].

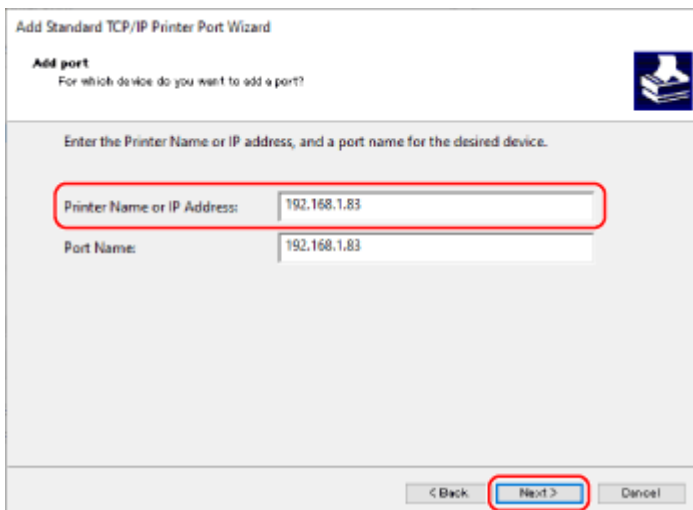

The port name is entered automatically, so change it, as needed.

**When [Additional port information required] Appears**

Take action following the instructions on the screen. To set [Device Type], select [Canon Network Printing Device with P9100] in [Standard].

- 6 Click [Finish].

⇒ A new port is added, and the [Printer Ports] screen is displayed.

## 7 Click [Close] ▶ [Close].

## Changing the Port Type and Number

If the machine is configured not to use LPD or RAW, you must change the type of port on the computer to a protocol usable on the machine.

If the LPD or RAW port number was changed, the settings on the computer may have to be changed to match the settings on the machine.

\* You do not need to change the port type or number on the computer for WSD ports.

Administrator privileges are required on each computer.

### 1 Log on to the computer using an administrator account.

### 2 Click [Start] (Start) ▶ [Settings] (Settings) ▶ [Devices] ▶ [Printers & scanners].

⇒ The [Printers & scanners] screen is displayed.

### 3 Click the printer driver of the machine ▶ [Manage] ▶ [Printer properties].

⇒ The printer driver properties screen is displayed.

### 4 On the [Ports] tab, click [Configure Port].

⇒ The [Configure Port] screen or [Configure Standard TCP/IP Port Monitor] screen is displayed.

### 5 Set the port type and number.

#### ■ For an MFNP Port

In [Protocol Type], select [RAW] or [LPR], and change the port number.

#### ■ For a Standard TCP/IP Port

In [Protocol Type], select [Raw] or [LPR].

- When [Raw] is selected, change the port number.
- When [LPR] is selected, enter "Ip" for [Queue Name].

### 6 Click [OK] ▶ [Close].

⇒ The settings are applied.

# Setting Up a Print Server

94WS-04A

By setting up a print server on the network, you can speed up print operations on a computer, thereby reducing the load on the computer.

In Windows, you can install the printer driver via the print server to save you the trouble of downloading the printer driver to each computer on the network or using a CD/DVD-ROM.

To set up a print server, enable the print server to print from the machine, and then configure the settings for sharing the printer.

To use a print server in a domain environment, consult your network administrator..

▶ **Enabling the Print Server to Print from the Machine(P. 179)**

▶ **Configuring the Settings for Sharing the Printer(P. 179)**

## Enabling the Print Server to Print from the Machine

Install the printer driver to the computer that will be the print server, and configure the settings according to your usage environment. ▶ **Preparing to Print from a Computer(P. 175)**

## Configuring the Settings for Sharing the Printer

Configure the printer sharing settings on the computer that will be the print server so that other computers on the network can use the print server.

▶ **When Using Windows(P. 179)**

▶ **When Using macOS(P. 181)**

### ■ When Using Windows

Administrator privileges are required on the computer that will be the print server.

#### Required Preparations

- Check the operating system (32-bit or 64-bit) of the computer that will be the print server and the operating system of the computer that will use the print server (the client). ▶ **Viewing the System Information of the Computer(P. 592)**

**1** Log on to the computer that will be the print server, using an administrator account.

**2** Click [  ] (Start) ▶ [  ] (Settings) ▶ [Devices] ▶ [Printers & scanners].

⇒ The [Printers & scanners] screen is displayed.

**3** Click the printer driver of the machine ▶ [Manage] ▶ [Printer properties].

⇒ The printer driver properties screen is displayed.

#### 4 On the [Sharing] tab, select the [Share this printer] checkbox, and enter a shared name.

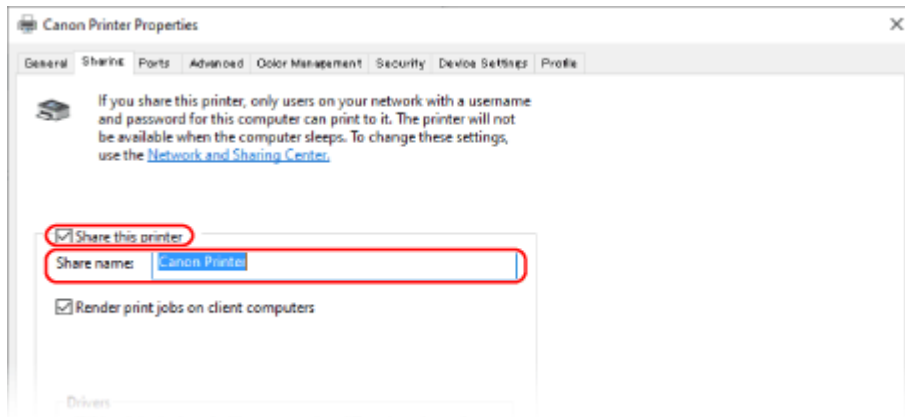

#### 5 Install an additional driver, as needed.

If the client computer has an operating system (32-bit or 64-bit) that differs from that of the print server, install an additional driver.

##### 1 Click [Additional Drivers].

⇒ The [Additional Drivers] screen is displayed.

##### 2 Select the checkbox of the driver to be added, and click [OK].

- If the print server computer has a 32-bit operating system, select the [x64] (driver for 64-bit version) checkbox.
- If the print server computer has a 64-bit operating system, select the [x86] (driver for 32-bit version) checkbox.

##### 3 Click [Browse], specify the folder where the driver is located, and click [OK].

##### When Specifying the Folder of the Downloaded Driver

- If the print server computer has a 32-bit operating system, specify the [x64] folder with the decompressed driver ► [Driver] folder.
- If the print server computer has a 64-bit operating system, specify the [32BIT] folder with the decompressed driver ► [Driver] folder.

##### When Specifying the Folder in the Supplied CD/DVD-ROM

- If the print server computer has a 32-bit operating system, specify [intdrv] in the CD/DVD-ROM ► [UFRII] ► [x64] ► [Driver] folder.
- If the print server computer has a 64-bit operating system, specify [intdrv] in the CD/DVD-ROM ► [UFRII] ► [32BIT] ► [Driver] folder.

##### 4 Install the additional driver while following the instructions on the screen.

#### 6 Click [OK].

⇒ The settings are applied.

## ■ When Using macOS

### **1** Click [ ] ▶ [System Preferences] ▶ [Sharing].

⇒ The [Sharing] screen is displayed.

### **2** Select the [Printer Sharing] checkbox.

### **3** In [Printers], select the checkbox of the machine.

### **4** Restrict the users that can use the print server, as needed.

By default, all users can use the print server.

To enable specific users to use the print server, click [+] under [Users], and select the users who can use the print server.

### **5** Close the [Sharing] screen.

⇒ The settings are applied.

# Printing from a Computer

94WS-04J

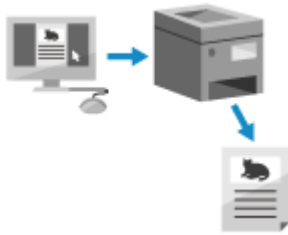

You can print documents from a computer using a printer driver. By changing the settings on the printer driver, you can print according to the document and purpose, such as by using 2-sided printing or adjusting the quality.

This section describes the general procedure for this operation. Check the manual of the application you are using for detailed operations on how to use it.

## Required Preparations

- Install the printer driver on the computer, and configure the settings according to your usage environment.
  - ▶ **Preparing to Print from a Computer(P. 175)**
- If the document or paper to print is a non-standard size, register the size to the printer driver. ▶ **Registering Non-standard Size Paper to the Computer (Custom Size)(P. 185)**

▶ **When Using Windows(P. 182)**

▶ **When Using macOS(P. 183)**

## ■ When Using Windows

- 1 On your computer, open the document you want to print.**
- 2 In the application used to open the document, select the command to print.**
- 3 Select the printer driver of the machine, and click [Preferences] or [Properties].**
  - ⇒ The [Printing preferences] screen of the printer driver is displayed.
- 4 In [Page Size] on the [Basic Settings] tab, select the paper size of the document.**



■ **When Printing on Paper of a Size Different from [Page Size]**

In [Output Size], select the paper size to print on. The document is enlarged or reduced to match the paper size in [Output Size].

**5 Configure the other print settings, as needed.**

Configure 2-sided printing and adjust the image quality and other settings to suit your document and purpose. For more information, click [Help] on the [Printing preferences] screen to display help.

**6 Click [OK], and click [Print] or [OK].**

⇒ Printing starts.

- You can cancel printing on the printing screen or from the printer icon in the Windows notification area. ▶ **Canceling Printing from a Computer(P. 187)**
- Use  or [Status Monitor] on the operation panel to view the print job status and log. ▶ **Viewing the Print Job Status and Log(P. 190)**

■ **When Using macOS**

**1 On your computer, open the document you want to print.**

**2 From the menu in the application used to open the document, click [Print].**

⇒ The printing dialog box appears.

**3 In [Printer], select the printer driver of the machine.**

**4 In [Paper Size] of the print options, select the paper size of the document.**

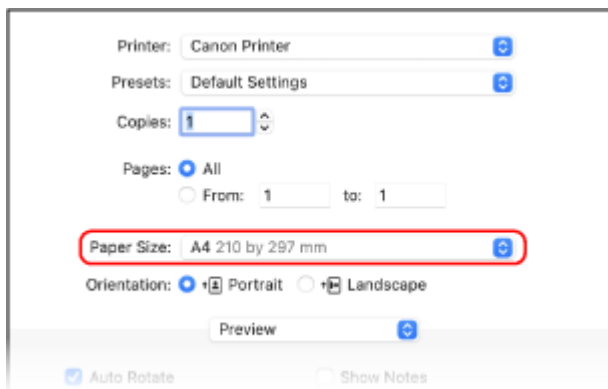

If print options are not displayed, click [Show Details] in the printing dialog box.

■ **When Printing on Paper of a Size Different from [Paper Size]**

- 1** From the print options pop-up menu, select [Paper Handling].



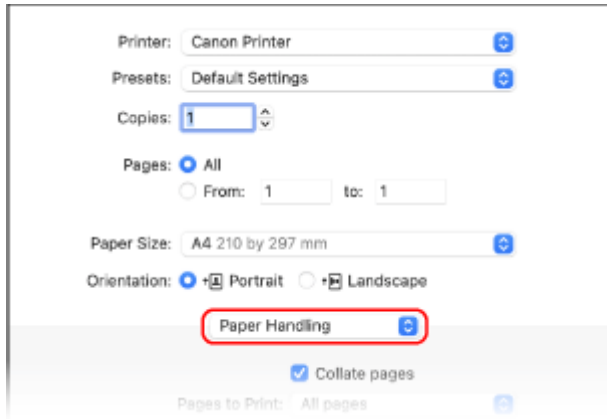

- 2** Select the [Scale to fit paper size] checkbox, and in [Destination Paper Size], select the paper size to print on.

The document is enlarged or reduced to match the paper size in [Destination Paper Size].

## **5** Configure the other print settings, as needed.

Configure 2-sided printing and adjust the image quality and other settings to suit your document and purpose. For more information, click [ ? ] in the printing dialog box to display help.

## **6** Click [Print].

⇒ Printing starts.

- You can cancel printing from the printer icon in the Dock. ▶ **Canceling Printing from a Computer(P. 187)**
- Use  or [Status Monitor] on the operation panel to view the print job status and log. ▶ **Viewing the Print Job Status and Log(P. 190)**

# Registering Non-standard Size Paper to the Computer (Custom Size)

94WS-04K

Custom size paper is non-standard size paper whose side lengths can be freely defined.

If the document or paper to print is a non-standard size, you must register the size to the printer driver in advance.

▶ When Using Windows(P. 185)

▶ When Using macOS(P. 185)

## ■ When Using Windows

**1** Click [Start] (Start) ▶ [Settings] (Settings) ▶ [Devices] ▶ [Printers & scanners].

⇒ The [Printers & scanners] screen is displayed.

**2** Click the printer driver of the machine ▶ [Manage] ▶ [Printing preferences].

⇒ The [Printing preferences] screen of the printer driver is displayed.

**3** On the [Page Setup] tab, click [Custom Paper Size].

**4** Enter the custom size paper name and paper size, and click [Register].

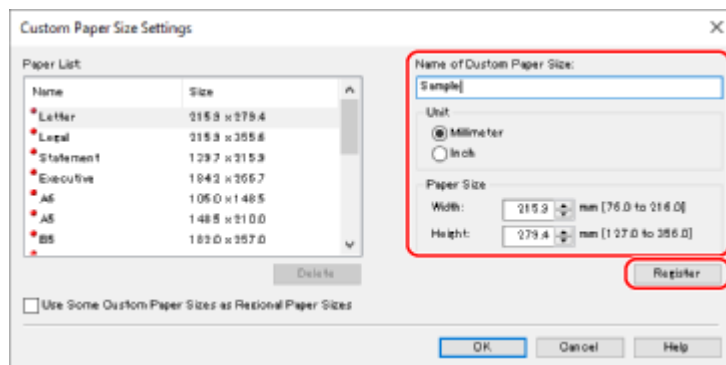

**5** Click [OK] ▶ [OK].

⇒ The custom size paper is registered.

## ■ When Using macOS

**1** On your computer, open the document you want to print.

**2** From the menu in the application used to open the document, click [Print].

⇒ The printing dialog box appears.

**3** In [Printer], select the printer driver of the machine.

**4** In [Paper Size] of the print options, select [Manage Custom Sizes].

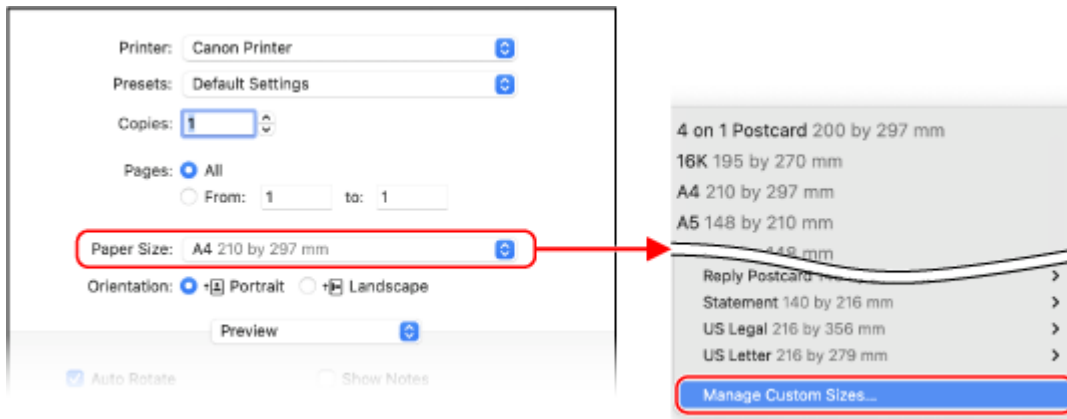

If print options are not displayed, click [Show Details] in the printing dialog box.

**5** Click [+] at the bottom left, double-click [Untitled], and enter the custom size paper name.

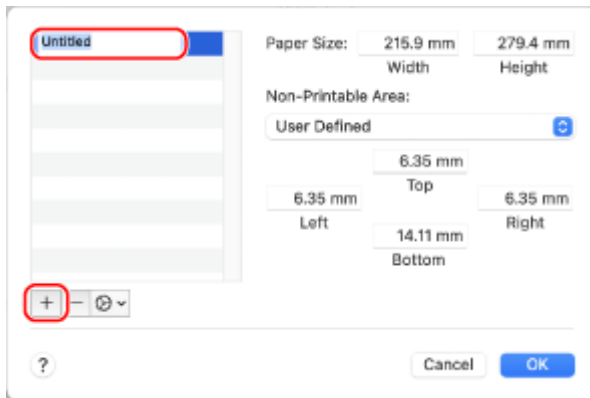

**6** Enter the paper size, and click [OK].

⇒ The custom size paper is registered.

# Canceling Printing

94WS-050

You can cancel printing from a computer. To cancel printing after the print data has been sent to the machine, use the operation panel or Remote UI.

- ▶ **Canceling Printing from a Computer(P. 187)**
- ▶ **Canceling Printing with the Operation Panel(P. 188)**
- ▶ **Canceling Printing with Remote UI(P. 189)**

## Canceling Printing from a Computer

- ▶ **When Using Windows(P. 187)**
- ▶ **When Using macOS(P. 187)**

### ■ When Using Windows

If the printing screen is displayed, click [Cancel].

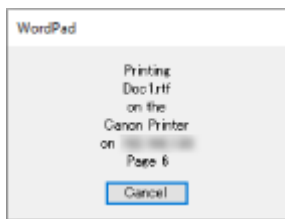

If the above screen is not displayed, double-click the printer icon in the Windows notification area, select the document to cancel, and click [Document] ▶ [Cancel] ▶ [Yes].

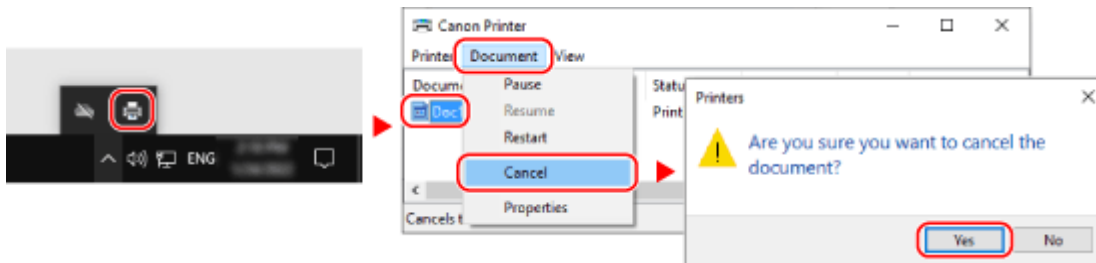

If the printer icon is not displayed in the Windows notification area or the document to be canceled is not displayed, the print data is sent to the machine after being processed on the computer.

In this case, cancel printing using the operation panel of the machine or Remote UI. ▶ **Canceling Printing with the Operation Panel(P. 188)**

### ■ When Using macOS

Click the printer icon in the Dock, select the document to cancel, and click [⌘].

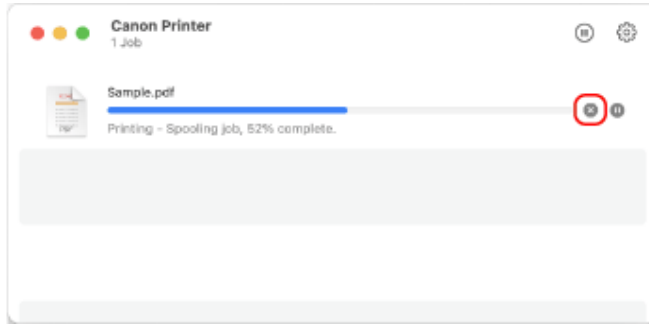

## Canceling Printing with the Operation Panel

▶ **Touch Panel Model(P. 188)**

▶ **5 Lines LCD Model(P. 188)**

### ■ Touch Panel Model

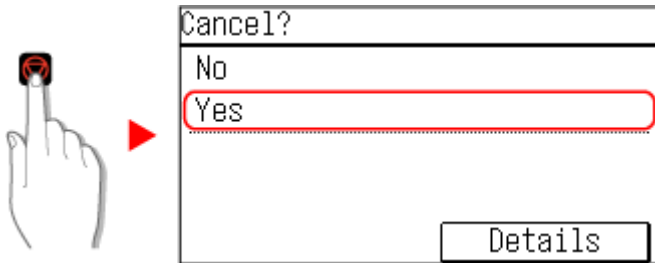

Press  on the operation panel ▶ [Yes]. ▶ **Operation Panel(P. 14)**



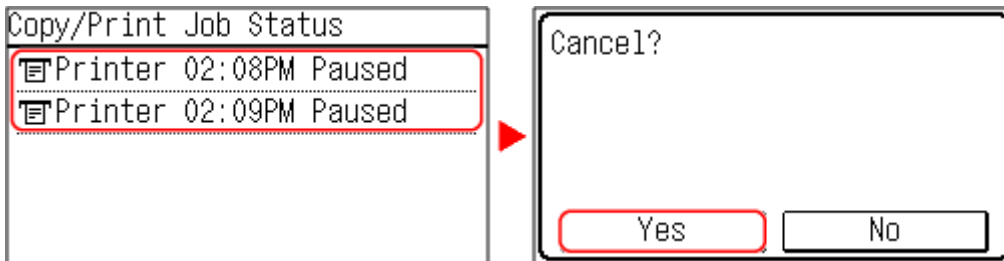

If the job list screen is displayed, select the job to cancel, and press [Yes].

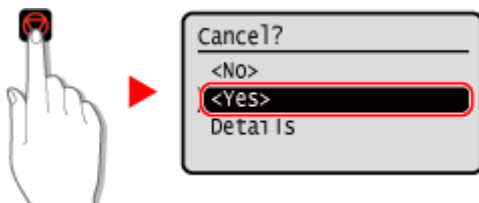

### ■ 5 Lines LCD Model

Press  on the operation panel ▶ [<Yes>] ▶ . ▶ **Operation Panel(P. 14)**



If the job list screen is displayed, select the job to cancel, and press  ▶ [<Yes>] ▶ .

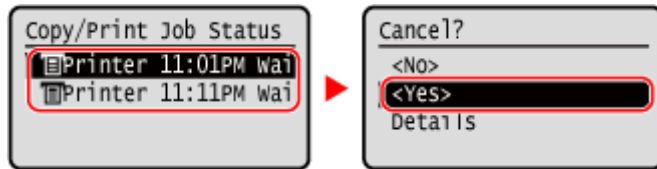

## Canceling Printing with Remote UI

You can cancel printing with [Status Monitor/Cancel] ▶ [Job Status] screen in [Print] of Remote UI. **▶Checking Usage and Logs with Remote UI(P. 353)**

# Viewing the Print Job Status and Log

94WS-051

Processes handled by the machine, including printing, are managed as jobs. By checking the status and log of jobs, you can determine whether a print job was performed correctly and the cause of errors that occurred.

\* If the log is set to not be displayed, you can only check the print job status. [▶\[Display Job Log\]\(P. 453\)](#)

This section describes how to view this information using the operation panel.

You can also check this information using Remote UI from a computer. [▶Checking Usage and Logs with Remote UI\(P. 353\)](#)

[▶Touch Panel Model\(P. 190\)](#)

[▶5 Lines LCD Model\(P. 191\)](#)

## Touch Panel Model

### 1 Press on the operation panel. [▶Operation Panel\(P. 14\)](#)

⇒ The [Status Monitor] screen is displayed.

### 2 Press [Copy/Print Job].

### 3 Check the print job status and log.

#### ■Viewing the Print Job Status

1 Press [Job Status].

2 Select a job to view its details.

⇒ The job details are displayed.

3 View the file name, user name, and other information.

Depending on the type of characters being used, the file name and user name may not be correctly displayed.

#### ■Viewing the Print Job Log

1 Press [Job Log].

2 Select a job to view its details.

⇒ The job details are displayed.

3 View the file name, user name, and other information.

Depending on the type of characters being used, the file name and user name may not be correctly displayed.

#### If Print Job Log Displays Error Information

Printing was canceled, or an error occurred.

If a three-digit number starting with "#" (error code) is displayed, you can check the cause and solution using the error code. [▶An Error Code Is Displayed\(P. 575\)](#)

## 5 Lines LCD Model

- 1** On the operation panel, press [Status Monitor] in the [Home] screen ▶ **OK**.  
▶[Home] Screen(P. 113)
- 2** Select [Copy/Print Job], press **OK**, and check the print job status and log .

### ■Viewing the Print Job Status

- 1** Select [Job Status], press **OK**.
- 2** Select a job to view its details and press **OK**.  
▶▶▶ The job details are displayed.
- 3** View the file name, user name, and other information.  
Depending on the type of characters being used, the file name and user name may not be correctly displayed.

### ■Viewing the Print Job Log

- 1** Select [Job Log], press **OK**.
- 2** Select a job to view its details and press **OK**.  
▶▶▶ The job details are displayed.
- 3** View the file name, user name, and other information.  
Depending on the type of characters being used, the file name and user name may not be correctly displayed.

### **If Print Job Log Displays Error Information**

Printing was canceled, or an error occurred.

If a three-digit number starting with "#" (error code) is displayed, you can check the cause and solution using the error code. ▶**An Error Code Is Displayed(P. 575)**



# Scanning

<b>Scanning</b> .....	193
<b>Preparing to Save Scanned Data to a Computer</b> .....	194
<b>Scanning (Saving to a Computer)</b> .....	196
<b>Scanning Using the Shortcut Key</b> .....	199
<b>Scanning from a Computer</b> .....	203
Starting MF Scan Utility .....	206
<b>Canceling Scanning</b> .....	207
<b>Checking the Save Status and Log of Scanned Data (Touch Panel Model)</b> .....	209

# Scanning

94WS-052

You can scan documents, photos, and other printed material ("originals") and convert them into data. This converted data ("scanned data") can be saved as an image or PDF file to a computer connected to the machine. You can configure the scan settings and save scanned data to a computer using the scanner driver and application installed on the computer.

The following two methods are available.

## Scanning from the Machine



Scan using the format and save destination preset with the application. This method saves scanned data to a computer by just operating the machine and is convenient when scanning multiple originals.

- ▶ **Preparing to Save Scanned Data to a Computer(P. 194)**
- ▶ **Scanning (Saving to a Computer)(P. 196)**
- ▶ **Scanning Using the Shortcut Key(P. 199)**

## Scanning from a Computer



Scan using the format and save destination specified when scanning. This method lets you see the scanned data immediately on the computer screen so you can check the image quality and make adjustments.

- ▶ **Preparing to Save Scanned Data to a Computer(P. 194)**
- ▶ **Scanning from a Computer(P. 203)**

\* In macOS, you can use the AirPrint function, which is standard in the OS, to scan data from a computer without having to install a scanner driver or application. ▶ **Using AirPrint Application to Print and Scan Data and Send Faxes(P. 293)**

### ■ See Also

#### Scanning from a Mobile Device

The machine can be operated from a smartphone, tablet, or other mobile device. This makes it easy to scan photos or documents from a mobile device using a compatible application or service.

- ▶ **Linking with Mobile Devices and Integrating with a Cloud Service(P. 273)**

# Preparing to Save Scanned Data to a Computer

94WS-054

Make the following preparations for each computer to which to save scanned data.

- ▶ **Step 1: Installing the Driver and Application to the Computer(P. 194)**
- ▶ **Step 2: Registering the Machine with a Computer(P. 194)**

## Step 1: Installing the Driver and Application to the Computer

Install the following driver and application on the computer to which to save scanned data. ▶ **Installing Software and Drivers to the Computer(P. 98)**

### ScanGear MF

This scanner driver is required to save scanned data to a computer.

When scanning with a computer, you can use this driver to adjust the scan settings while checking the results.

### MF Scan Utility

This is the application for scanning.

Use this to easily scan photos and documents from a computer. You can also change the scan settings for when performing scanning operations with the machine.

## Step 2: Registering the Machine with a Computer

For both of the following cases, you must register the machine with the computer used as the save destination.

- Performing scanning operations with the machine
- Setting a computer connected to a network as the save destination

You do not have to register the machine when scanning from a computer or saving scanned data to a USB-connected computer.

- ▶ **When Using Windows(P. 194)**
- ▶ **When Using macOS(P. 195)**

### ■ When Using Windows

- 1** Click [  ] (Canon MF Network Scanner Selector) displayed in the Windows notification area.

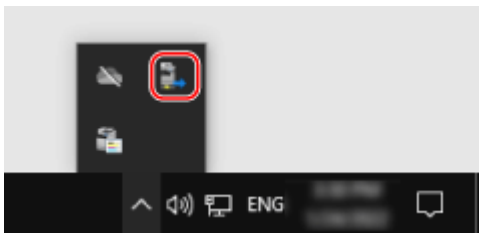

- 2** Select the checkbox for this machine, and click [OK].

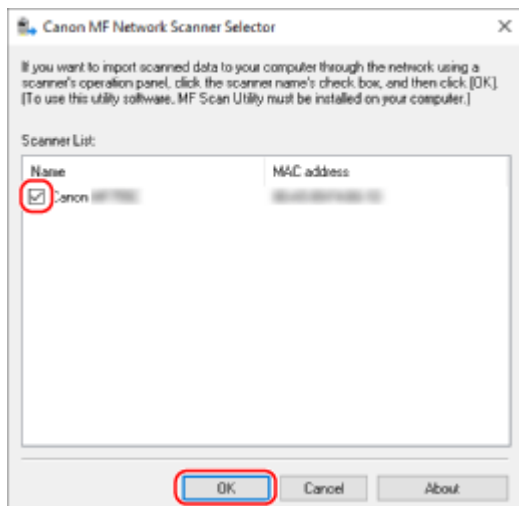

## ■ When Using macOS

Use MF Scan Utility to register the machine.

### 1 From the OS Applications folder, double-click [Canon MF Utilities] ▶ [Canon MF Scan Utility].

⇒ MF Scan Utility starts.

### 2 Click [Canon MF Scan Utility] ▶ [Network Scanner Settings].

### 3 Click [+] at the bottom left.

### 4 Add the machine on each tab according to the connection method.

#### ■ Connecting with Bonjour

On the [Bonjour] tab, select the Bonjour name, and then click [Add].

#### ■ Connecting with TCP/IP

On the [IP] tab, enter the IP address of the machine, and then click [Add].

### 5 Restart MF Scan Utility.

⇒ The added machine is displayed in [Product Name:] on the [Canon MF Scan Utility] main dialog box.

## Scanning (Saving to a Computer)

94WS-05H

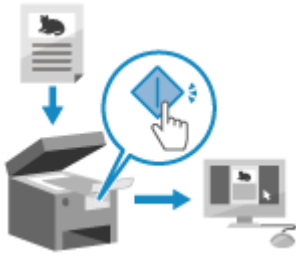

You can scan an original and save the scanned data to a computer connected to the machine. By just operating the machine, you can save scanned data to a computer. The original is scanned and the data is saved according to the settings of MF Scan Utility installed on the computer.

### Required Preparations

- Make preparations such as installing the scanner driver (ScanGear MF) and application (MF Scan Utility) to the computer used as the save location. ▶ **Preparing to Save Scanned Data to a Computer(P. 194)**
- If the ScanGear MF screen appears on the computer used as the save location, close the screen.

▶ **Touch Panel Model(P. 196)**

▶ **5 Lines LCD Model(P. 197)**

### Touch Panel Model

**1 Place the original.** ▶ **Placing Originals(P. 129)**

**2 On the operation panel, press [Scan] in the [Home] screen.** ▶ **[Home] Screen(P. 113)**

⇒ The scan type selection screen is displayed.

**3 Press [Computer].**

⇒ The screen to select the computer to be used as the save location is displayed.

When you are using the machine only with a USB-connected computer, the scan screen is displayed.

**4 Select the scan setting, and press .**

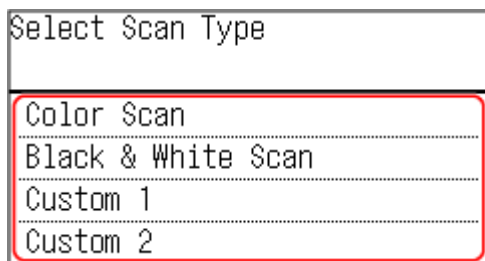

⇒ Scanning of the original starts.

- The scanned data format, save location on the computer, and other settings are set for each scan setting. The original is scanned according to the selected scan setting.

- To cancel scanning, press [Cancel] ► [Yes] . ◀ **Canceling Scanning(P. 207)**
- When scanning is completed, the destination folder is displayed on the screen of the selected computer.
  - \* By default, a subfolder with the scanning date is created in the [Documents] folder (Windows) or the [Pictures] folder (macOS), and the scanned data is saved to that folder.

### ■ When [Scan Next: Press Start] appears

When an original is placed on the platen glass and is scanned, the screen for scanning additional originals is displayed.

To continue scanning originals, place them on the platen glass, and press .

Press [Finish Scan] to save the scanned data.



\* If the size of the original is different, part of the image may be missing, or the image may be scanned smaller.

## 5 Lines LCD Model

### 1 Place the original. ▶ **Placing Originals(P. 129)**

### 2 On the operation panel, press [Scan] in the [Home] screen ▶ . ▶ **[Home] Screen(P. 113)**

⇒ The scan type selection screen is displayed.

### 3 Press [Computer] ▶ .



⇒ The screen to select the computer to be used as the save location is displayed.

When you are using the machine only with a USB-connected computer, the scan screen is displayed.

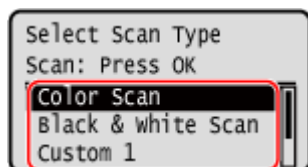
### 4 Select the scan setting, and press .



⇒ Scanning of the original starts.

- The scanned data format, save location on the computer, and other settings are set for each scan setting. The original is scanned according to the selected scan setting.
- To cancel scanning, press [<Cancel>] ►  ► [Yes] ►  . ▶ **Canceling Scanning(P. 207)**
- When scanning is completed, the destination folder is displayed on the screen of the selected computer.
  - \* By default, a subfolder with the scanning date is created in the [Documents] folder (Windows) or the [Pictures] folder (macOS), and the scanned data is saved to that folder.

### ■ When [Scan Next: Press Start] appears

When an original is placed on the platen glass and is scanned, the screen for scanning additional originals is displayed.

To continue scanning originals, place them on the platen glass, and press .

Press [<Finish Scanning>]   to save the scanned data.

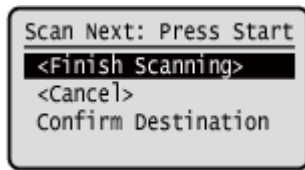

\* If the size of the original is different, part of the image may be missing, or the image may be scanned smaller.

## NOTE

### Checking or Changing Scan Setting or Save Location

- You can check and change the scan setting selected in step 5 by using the MF Scan Utility on the computer used as the save location.  **Starting MF Scan Utility(P. 206)**

## Scanning Using the Shortcut Key

94WS-0J7

This registers the scan settings and the computer where scanned data will be saved to a shortcut key so that you can quickly perform a scan from [Home] screen on the operation panel.

▶ **Registering the Scan Settings and a Computer as the Save Location in the Shortcut Key(P. 199)**

▶ **Using the Shortcut Key(P. 201)**

### Required Preparations

- Make preparations such as installing the scanner driver (ScanGear MF) and application (MF Scan Utility) to the computer used as the save location. ▶ **Preparing to Save Scanned Data to a Computer(P. 194)**
- If the ScanGear MF screen appears on the computer used as the save location, close the screen.

## Registering the Scan Settings and a Computer as the Save Location in the Shortcut Key

Use the operation panel to configure the settings. You cannot configure the settings using Remote UI from a computer.

▶ **Touch Panel Model(P. 199)**

▶ **5 Lines LCD Model(P. 200)**

### ■ Touch Panel Model

- 1** On the operation panel, press [Menu] in the [Home] screen. ▶ **[Home] Screen(P. 113)**
- 2** Press [Function Settings] ▶ [Send] ▶ [Scan and Send Settings].
- 3** Press [Shortcut Key Settings] ▶ [Register]
- 4** Select the shortcut key to which you want to register settings.
- 5** Select the method for connecting to the computer to be used as the save location.

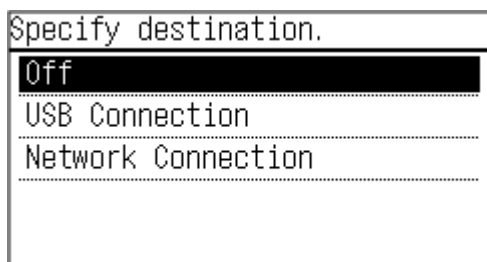



## 6 Select the computer to be used as the save location.

If you select [USB Connection] in step 5, proceed to step 7.

## 7 Select the scan type.

- The scanned data format, the save location on the computer, and other settings are specified for each set of scan settings. The original is scanned according to the selected scan settings.
- You can check and change the scan settings by using the MF Scan Utility on the computer used as the save location. ▶ **Starting MF Scan Utility(P. 206)**
- For macOS, see the relevant driver and software manuals at the online manual site.

### ■ 5 Lines LCD Model

**1** On the operation panel, select [Menu] in the [Home] screen, and press **OK**. ▶ [Home] Screen(P. 113)

**2** Press [Function Settings] ▶ **OK** ▶ [Send] ▶ **OK** ▶ [Scan and Send Settings] ▶ **OK**.

**3** Press [Shortcut Key Settings] ▶ **OK** ▶ [Register] ▶ **OK**.

**4** Press the shortcut key ▶ **OK**.

**5** Select the method for connecting to the computer to be used as the save location, and press **OK**.

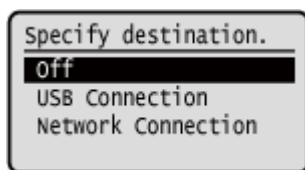

**6** Select the computer to be used as the save location, and press **OK**.

If you select [USB Connection] in step 5, proceed to step 7.

**7** Select the scan type, and press **OK**.

- The scanned data format, the save location on the computer, and other settings are specified for each set of scan settings. The original is scanned according to the selected scan settings.
- You can check and change the scan settings by using the MF Scan Utility on the computer used as the save location. ▶ **Starting MF Scan Utility(P. 206)**
- For macOS, see the relevant driver and software manuals at the online manual site.

## NOTE

### Checking Registered Save Locations and Scan Settings

- Touch Panel Model  
Press [Shortcut Key Settings] ▶ [Confirm Destination] ▶ Shortcut key in step 3.
- 5 Lines LCD Model  
Press [Shortcut Key Settings] ▶ **OK** ▶ [Confirm Destination] ▶ **OK** ▶ Shortcut key in step 3.

### Deleting Registered Save Locations and Scan Settings

- Touch Panel Model  
Press [Off] in step 5.
- 5 Lines LCD Model  
Press [Off] ▶ **OK** in step 5.

## Using the Shortcut Key

▶ **Touch Panel Model(P. 201)**

▶ **5 Lines LCD Model(P. 202)**

### ■ Touch Panel Model

**1 Place the original.** ▶ **Placing Originals(P. 129)**

**2 On the operation panel, press [Scan ▶ PC1] or [Scan ▶ PC2] in the [Home] screen.** ▶ **[Home] Screen(P. 113)**

⇒ Scanning of the original starts.

- To cancel scanning, press [Cancel] ▶ [Yes]. ▶ **Canceling Scanning(P. 207)**
- When scanning is completed, the destination folder is displayed on the screen of the selected computer.  
\* By default, a subfolder with the scanning date is created in the [Documents] folder (Windows) or the [Pictures] folder (macOS), and the scanned data is saved to that folder.

### ■ When [Scan Next: Press Start] appears

When an original is placed on the platen glass and is scanned, the screen for scanning additional originals is displayed.

To continue scanning originals, place them on the platen glass, and press **OK**.

Press [Finish Scan] to save the scanned data.





\* If the size of the original is different, part of the image may be missing, or the image may be scanned smaller.

## ■ 5 Lines LCD Model

### 1 Place the original. ▶ Placing Originals(P. 129)

### 2 On the operation panel, press [Scan ▶ PC] in the [Home] screen ▶ . ▶ [Home] Screen(P. 113)

⇒ Scanning of the original starts.

- To cancel scanning, press [<Cancel>] ▶  ▶ [Yes] ▶ . ▶ **Canceling Scanning(P. 207)**
- When scanning is completed, the destination folder is displayed on the screen of the selected computer.  
\* By default, a subfolder with the scanning date is created in the [Documents] folder (Windows) or the [Pictures] folder (macOS), and the scanned data is saved to that folder.

### ■ When [Scan Next: Press Start] appears

When an original is placed on the platen glass and is scanned, the screen for scanning additional originals is displayed.

To continue scanning originals, place them on the platen glass, and press .

Press [<Finish Scanning>] ▶  to save the scanned data.

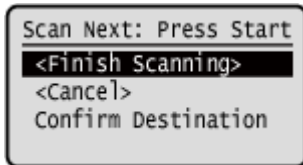

\* If the size of the original is different, part of the image may be missing, or the image may be scanned smaller.

## Scanning from a Computer

94WS-05R



You can scan an original and save the scanned data to a computer connected to the machine. You can set the format and save location when scanning from a computer. This method lets you see the scanned data immediately on the computer screen so you can check the image quality and make adjustments.

Use either of the following applications to perform scanning.

### Dedicated application (MF Scan Utility)

Scan easily using the setting to suit your purpose. Send scanned data to a specified application to display it and send it by e-mail. You can also use the ScanGear MF screen to configure advanced settings.

▶ **Using a Dedicated Application to Perform Scanning - MF Scan Utility(P. 203)**

### Other TWAIN- and WIA-supported Applications

You can also use image processing software, document software, and other applications that support TWAIN\*<sup>1</sup> or WIA\*<sup>2</sup>. Scanned data is imported directly to the application for immediate editing and processing. Check the manual of the application you are using to see if it supports TWAIN or WIA.

▶ **Scanning Using Other TWAIN- and WIA-supported Applications(P. 204)**

\*<sup>1</sup> TWAIN is a standard for connecting a scanner or other image input device to a computer.

\*<sup>2</sup> WIA is a function that comes standard in Windows.

## Using a Dedicated Application to Perform Scanning - MF Scan Utility

After placing an original on the machine, scan using MF Scan Utility on a computer.

### Required Preparations

- Install the scanner driver (ScanGear MF) and application (MF Scan Utility) on the computer. ▶ **Installing Software and Drivers to the Computer(P. 98)**

- 1 Place the original on the machine.** ▶ **Placing Originals(P. 129)**
- 2 Start MF Scan Utility on a computer.** ▶ **Starting MF Scan Utility(P. 206)**
- 3 For [Scanner], select the machine.**
- 4 Click the button corresponding to the original type and purpose to start scanning.**

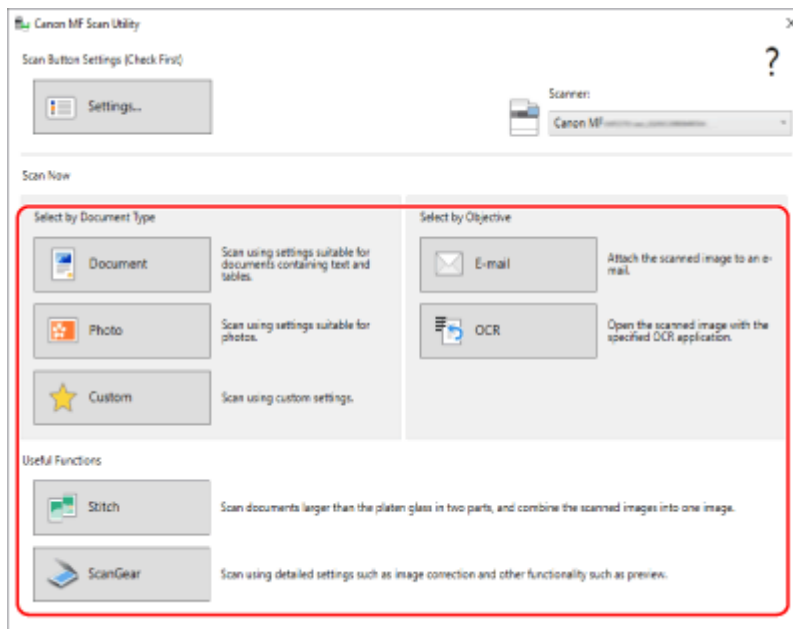

Click [ScanGear] to display ScanGear MF and configure the advanced scan settings. For more information, click [ ? ] on ScanGear MF to display help.

## NOTE

### When Scanning Cannot Be Performed

- The machine may not be online (scan standby mode). On the operation panel, select [Scan] in the [Home] screen, and press [Remote Scanner] or select [Remote Scanner], and press **OK** to turn the machine online, and then repeat the operation.

## Scanning Using Other TWAIN- and WIA-supported Applications

After placing an original on the machine, scan using other TWAIN- and WIA-supported application on your computer. This section describes the general procedure for this operation. Check the manual of the application you are using for detailed operations on how to use it.

### Required Preparations

- Install the scanner driver (ScanGear MF) on the computer. **▶Installing Software and Drivers to the Computer(P. 98)**

- 1 Place the original on the machine. ▶Placing Originals(P. 129)**
- 2 On the computer, start the application used to import the scanned data.**
- 3 In the application, select the command to start the scanning operation.**
- 4 Select the scanner driver (ScanGear MF or WIA) of the machine, and configure the scan settings.**

For more advanced scan settings, select ScanGear MF. For more information, click [ ? ] on ScanGear MF to display help.

### **5 Start scanning.**

⇒ When scanning is completed, the scanned data is imported to the application.

If the next pages of the original are not scanned or an error message appears after scanning is completed, place the originals on the machine one at a time and perform scanning.

## **NOTE**

### **When Scanning Cannot Be Performed**

- The machine may not be online (scan standby mode). On the operation panel, select [Scan] in the [Home] screen, and press [Remote Scanner] or select [Remote Scanner], and press **OK** to turn the machine online, and then repeat the operation.

## Starting MF Scan Utility

---

94WS-05S

Start MF Scan Utility installed on the computer.

### ■ When Using Windows

Click [  ] (Start) ▶ [Canon] ▶ [MF Scan Utility].

### ■ When Using macOS

From the OS Applications folder, double-click [Canon MF Utilities] ▶ [Canon MF Scan Utility].

## NOTE

- For more information on the operations and settings of MF Scan Utility, click [Instructions] on the MF Scan Utility screen to display help.

# Canceling Scanning

Follow the instructions on screen to cancel a scanning operation.

▶ **Touch Panel Model (P. 207)**

▶ **5 Lines LCD Model (P. 207)**

## Touch Panel Model

Press [Cancel] ▶ [Yes].

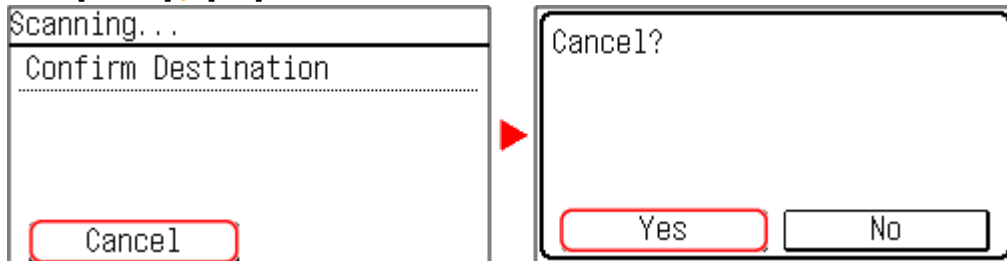

If the above screen is not displayed, press  on the operation panel, and then press [Yes].

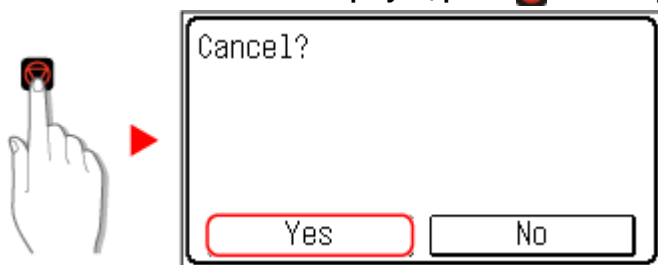

If the job list screen is displayed, select the job to cancel, and press [Yes].

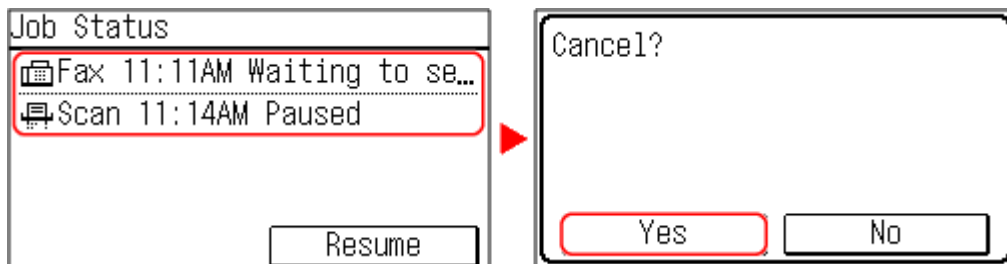

## 5 Lines LCD Model

Press [<Cancel>] ▶  ▶ [Yes] ▶ .

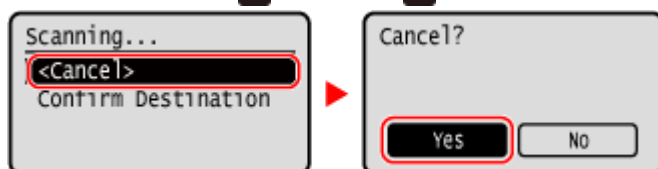

If the above screen is not displayed, press  on the operation panel, and then press [Yes] ▶ .

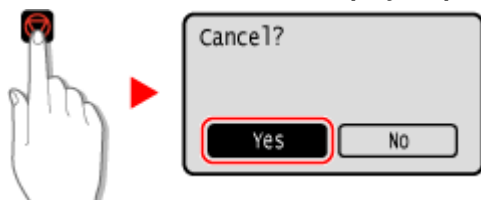



If the job list screen is displayed, select the job to cancel, and press **OK** ► **[Yes]** ► **OK**.

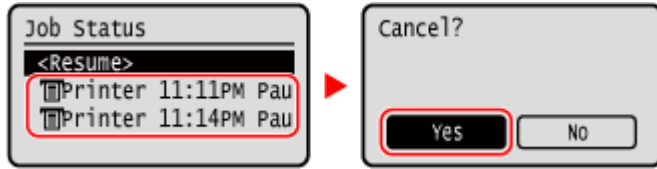

# Checking the Save Status and Log of Scanned Data (Touch Panel Model)

94WS-05X

You can check the save status and log of data scanned with the machine. Processes handled by the machine, including saving scanned data, are managed as jobs. By checking the status and log of jobs, you can determine whether a scan job was performed correctly and the cause of errors that occur.

\* If the log is hidden, you can only check the send and save status. [▶\[Display Job Log\]\(P. 453\)](#)

This section describes how to check the status and log using the operation panel.

You can also use Remote UI from a computer to check the status and log. [▶Checking Usage and Logs with Remote UI\(P. 353\)](#)

**1** Press  on the operation panel. [▶Operation Panel\(P. 14\)](#)

**2** Press [TX Job].

**3** Check the status and log on the [Job Status] or [Job Log].

## ■Checking the Save Status

- 1** On the [Job Status], check the job being processed or waiting to be processed.
- 2** Select a job to view its details.
  - ▢ The job details are displayed.
- 3** Check the number of pages and the destination.
  - For jobs with multiple destinations, press [Destination:] to display the list of destinations.

## ■Checking the Save Log

- 1** On the [Job Log], check the completed save jobs.
- 2** Select a job to view its details.
  - ▢ The job details are displayed.
- 3** Check the number of pages and the destination.
  - For jobs with multiple destinations, press [Destination:] to display the list of destinations.

### If Save Log Displays [Error]

Saving was canceled, or an error occurred.

If a three-digit number starting with "#" (error code) is displayed, you can check the cause and solution using the error code. [▶An Error Code Is Displayed\(P. 575\)](#)

# Faxing

<b>Faxing</b> .....	211
<b>Preparing to Send and Receive Faxes</b> .....	212
Preparing to Send Faxes from a Computer .....	213
Changing Fax RX Mode and Setting the Action when Receiving a Fax .....	215
Changing the Fax Number and Unit Name .....	217
<b>Forwarding Faxes and Configuring the Backup Settings</b> .....	218
Auto Forwarding and Backing Up Received Faxes .....	219
<b>Sending Faxes</b> .....	221
Sending a Fax after a Phone Conversation (Manual Sending) .....	223
<b>Sending Faxes from a Computer (PC Faxing)</b> .....	225
Securely Sending PC Faxes .....	228
<b>Fax Original Scan Settings</b> .....	229
<b>Receiving Faxes</b> .....	231
Receiving Faxes via Telephone (Remote RX) .....	232
Changing the Print Settings for Received Faxes .....	233
<b>Canceling Fax Sending</b> .....	235
<b>Checking the Status and Log for Sent and Received Faxes</b> .....	236

# Faxing

---

Faxing is the sending and receiving of documents and photos as black and white images over a telephone line.

## Sending Faxes

---

The following two methods are available:

### Sending a Fax from the Machine



You can scan a document, photo, or other printed materials (originals) with the machine, converting it to a black and white image, and then send it.

▶ **Sending Faxes(P. 221)**

### Sending a Fax from a Computer

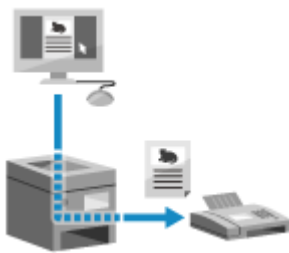

You can convert a document or photo to a black and white image and send it via a fax driver installed on a computer connected to the machine.

You can send a fax in the same way as printing a document or photo from a computer. To send a fax, you do not need to prepare printed materials.

▶ **Preparing to Send Faxes from a Computer(P. 213)**

▶ **Sending Faxes from a Computer (PC Faxing)(P. 225)**

\* In macOS, you can use the AirPrint function that is standard in the OS to send data from a computer without having to install a fax driver. ▶ **Using AirPrint Application to Print and Scan Data and Send Faxes(P. 293)**

## Receiving Faxes

---

When the machine is set to receive faxes automatically, faxes are received without the incoming ringing. If the machine rings, you can pick up the handset to determine whether it is a call or a fax. If it is a fax, you can receive it.

▶ **Receiving Faxes(P. 231)**

Received faxes can also be forwarded or saved automatically to a specific destination.

▶ **Auto Forwarding and Backing Up Received Faxes(P. 219)**

## ■ See Also

### Restricting Printing of Received Faxes

You can temporarily save received faxes in the memory of the machine without printing them.

▶ **Saving Received Documents in the Machine (Memory Lock) (Touch Panel Model)(P. 331)**

## Preparing to Send and Receive Faxes

---

94WS-060

To send and receive faxes with the machine, you must use the operation panel (Fax Setup Guide) to configure the initial settings. You cannot configure the initial settings using Remote UI from a computer. [▶Configuring the Fax Settings \(Fax Setup Guide\) \(Touch Panel Model\)\(P. 94\)](#)

### When Sending Faxes from a Computer

You must make the necessary preparations on each computer used to send faxes.

[▶Preparing to Send Faxes from a Computer\(P. 213\)](#)

### To Change the Initial Settings

You can change the settings configured with Fax Setup Guide individually.

[▶Changing Fax RX Mode and Setting the Action when Receiving a Fax\(P. 215\)](#)

[▶Changing the Fax Number and Unit Name\(P. 217\)](#)

## NOTE

- The sender's information, including the sent date and time and fax number of the machine, is printed together with the fax data at the destination. You can change the print position and the mark added to the fax number or choose to not print this. [▶\[TX Terminal ID\]\(P. 439\)](#)
- To automatically forward or save received faxes, you must configure separate settings. [▶Forwarding Faxes and Configuring the Backup Settings\(P. 218\)](#)

# Preparing to Send Faxes from a Computer

94WS-061

Make the following preparations for each computer used to send faxes.

- ▶ **Step 1: Installing the Driver to the Computer(P. 213)**
- ▶ **Step 2: Configuring the Settings for Secure Sending(P. 213)**
- ▶ **Step 3: Test Fax Sending(P. 214)**

## Step 1: Installing the Driver to the Computer

Install the fax driver to the computer that will be used to send faxes. ▶ **Installing Software and Drivers to the Computer(P. 98)**

## Step 2: Configuring the Settings for Secure Sending

While sending faxes from a computer can be convenient, there is a risk of sending them to incorrect numbers. To reduce this risk, it is recommended that you configure the following settings using the fax driver.

- ▶ **When Using Windows(P. 213)**
- ▶ **When Using macOS(P. 213)**

### ■ When Using Windows

#### 1 Click [Start] (Start) ▶ [Settings] (Settings) ▶ [Devices] ▶ [Printers & scanners].

⇒ The [Printers & scanners] screen is displayed.

#### 2 Click the fax driver of the machine ▶ [Manage] ▶ [Printing preferences].

⇒ The [Printing preferences] screen of the fax driver is displayed.

#### 3 Configure the settings for secure sending.

- Enable confirmation of fax number.
- Set an external connecting number.
- Keep a TX Job Log.

For more information, click [Help] on the [Printing preferences] screen to display help.

### ■ When Using macOS

Configure the settings to safely send faxes using the print dialog box (fax driver setting screen).

- Enable confirmation of fax number.
- Set an external connecting number.

For more information, click [ ? ] in the print dialog box to display help.

### Step 3: Test Fax Sending

When installation and setup are complete, you can test to see if you can send faxes correctly. [▶ Sending Faxes from a Computer \(PC Faxing\)\(P. 225\)](#)

# Changing Fax RX Mode and Setting the Action when Receiving a Fax

94WS-062

You can change the RX mode from the default setting.

When [Fax/Tel (Auto Switch)] is enabled to determine whether the incoming call is a fax, you can also configure settings such as the ring time.

Use the operation panel to configure the settings. You cannot configure the settings using Remote UI from a computer.

**1 On the operation panel, press [Fax] in the [Home] screen. ▶[Home] Screen(P. 113)**

**2 Press [RX Mode:].**

⇒ The [RX Mode] screen is displayed.

**3 Select the RX mode.**

## ■When Using a Telephone or the Optional TELEPHONE 6 KIT Without Connecting to the Machine

Select [Auto]. Used for fax only.

- Faxes are automatically received.
- Incoming telephone calls cannot be answered.

## ■When Connecting a Regular Telephone or TELEPHONE 6 KIT

### When Automatically Receiving Faxes

Select [Fax/Tel (Auto Switch)]. Enables use of both fax and phone.

- Faxes are automatically received.
- When a telephone call is received, the machine rings. Pick up the handset to answer the call.

### When Manually Receiving Faxes

Select [Manual]. Enables use of both fax and phone.

- The machine rings when receiving both fax and phone calls.
- If you hear a fax tone when picking up the handset, receive the fax manually. ▶**Receiving Faxes(P. 231)**
- You can also configure the setting to receive faxes automatically after the machine rings for a certain period of time. ▶**[Switch to Auto RX](P. 445)**

## ■When Connecting an Answering Machine

Select [Answering Machine]. Enables use of both fax and phone.

- Faxes are automatically received.
- When a telephone call is received, the answering machine function can be used to record messages. You can answer the call by picking up the handset before recording starts.
  - \* Set the answering machine so that the recording function activates after the machine rings one or two times.
  - \* When recording your message, it is recommended that you keep about four seconds of silence, or keep the entire message within 20 seconds.



## 4 Set the ring time and action when receiving a fax, and press [Apply].

Set this when [Fax/Tel (Auto Switch)] is selected for RX mode. If you selected another RX mode, this step is not required.

Fax/Tel (Auto Switch)
Ring Start Time: 8
Incoming Ring Time: 22
After Ring: Receive
Apply

### [Ring Start Time]

Specify the time to determine whether an incoming call is a fax or a phone call. The machine does not ring at this time.

Reception starts when the machine determines that the call is a fax.

### [Incoming Ring Time]

Specify the ring time for incoming calls when it is determined that the call is not a fax.

### [Action After Ring]

Select the action to take when the handset is not picked up while ringing.

Select [End] to disconnect the call, or select [Receive] to receive the fax.

## NOTE

### Connecting a Telephone or the Optional TELEPHONE 6 KIT

- For details about connecting a telephone or the optional TELEPHONE 6 KIT, use the procedure to connect to the telephone line. ▶ **Step 4: Connecting to Telephone Line(P. 96)**

### [Net Switch]

- Depending on your country, [Net Switch] may appear as an RX mode. In this mode, the machine distinguishes between receiving phone calls and faxes. To use this mode, you must subscribe to a network switch service.
- You must connect the machine to an external telephone or optional handset kit in advance.

# Changing the Fax Number and Unit Name

---

94WS-063

You can change the information registered to the machine such as when the fax number changes after a move or you want to change the name notified to the destination.

This section describes how to configure the settings using Remote UI from a computer.

On the operation panel, select [Menu] in the [Home] screen, and then select [Function Settings] to configure the settings. [▶\[Set Line\]\(P. 437\)](#)

Administrator privileges are required.

**1 Log in to Remote UI in System Manager Mode.** [▶Starting Remote UI\(P. 349\)](#)

**2 On the Portal page of Remote UI, click [Settings/Registration].** [▶Portal Page of Remote UI\(P. 351\)](#)

**3 Click [TX Settings] ▶ [Fax TX Settings] ▶ [Edit].**

⇒ The [Edit Fax TX Settings] screen is displayed.

**4 Change the fax number and unit name.**

- Enter the fax number in [Unit Telephone Number] in [Set Line].
- Enter the unit name in [Unit Name] in [Basic Settings].

**5 Click [OK].**

⇒ The settings are applied.

**6 Log out from Remote UI.**

## Forwarding Faxes and Configuring the Backup Settings

94WS-064

Faxes can be forwarded and saved automatically to a specific destination when they are received. This is convenient when you want to check received faxes from a remote location or you want to back up faxes you sent or received.

### ▶ Auto Forwarding and Backing Up Received Faxes(P. 219)

## NOTE

### Forwarding Essential Faxes Only

- You can also select a specific fax from the RX Job Log and send it to a specific destination. ▶ **Checking the Status and Log for Sent and Received Faxes(P. 236)**

# Auto Forwarding and Backing Up Received Faxes

94WS-066

You can configure the settings to automatically forward and save a received fax to a destination specified in advance. You can also specify whether to print the received fax on the machine.

This section describes how to configure the settings using Remote UI from a computer. On the operation panel, select [Menu] in the [Home] screen, and then select [Function Settings] to configure the settings. **▶[Forwarding Settings](P. 446)**  
Administrator privileges are required.

## Required Preparations

- Register the destination to be specified to the Address Book of the machine. **▶Registering Destinations (Address Book) (Touch Panel Model)(P. 147)**

- 1 Log in to Remote UI in System Manager Mode. ▶Starting Remote UI(P. 349)**
- 2 On the Portal page of Remote UI, click [Settings/Registration]. ▶Portal Page of Remote UI(P. 351)**
- 3 Click [RX/Forwarding Settings] ▶ [Fax RX Settings] ▶ [Edit] in [Forwarding Settings].**  
 ▶▶ The [Edit Forwarding Settings] screen is displayed.
- 4 Select the [Use Forwarding Function] checkbox, and click [Select from Address Book].**  
 ▶▶ The [Select from Address Book] screen is displayed.
- 5 Select the destination, and click [OK].**  
 ▶▶ The [Edit Forwarding Settings] screen reappears.
- 6 Set whether to print faxes or save them in memory.**
  - **When Printing Faxes on the Machine**  
In [Print Images], select [On]. To print only when forwarding fails, select [Print Only When Error Occurs].
  - **When Saving Faxes that Cannot Be Forwarded to the Memory of the Machine**  
In [Store Images in Memory], select [Store Only When Error Occurs].  
Faxes saved to the memory can be viewed in [Status Monitor]. **▶Checking Faxes that Failed to Be Forwarded(P. 237)**
- 7 Enter any string in [File Name], as needed.**
  - If you selected a fax number as the destination, this step is not required. Proceed to Step 8.

- If you selected a destination other than a fax number, a PDF file is forwarded or saved with the following file name.

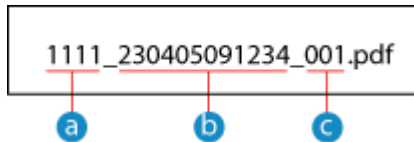

- a** Communications management number
- b** Date sent (in this example, "April 5, 2023, 9:12:34 AM")
- c** File sequence number (if one file, then "001")

When you enter a string in [File Name], the specified string is appended to the start of the above file name.

## 8 Click [OK].

⇒ The settings are applied.

## 9 Log out from Remote UI.

# Sending Faxes

94WS-067



You can scan a document, photo, or other printed materials (originals) with the machine, converting it to a black and white image, and then send it. You can also send a fax after a phone conversation. **▶ Sending a Fax after a Phone Conversation (Manual Sending)(P. 223)**

## 1 Place the original. ▶ Placing Originals(P. 129)

## 2 On the operation panel, press [Fax] in the [Home] screen. ▶ [Home] Screen(P. 113)

⇒ The Fax screen appears.

## 3 Press .

If the destination setting for the previously sent fax remains, a fax may be sent to an incorrect destination. Reset the setting before operating.

## 4 Press [Destination], and specify the destination. ▶ Specifying Destinations (Touch Panel Model)(P. 159)

Specify destination.	
01/11 2022 12:00PM	
☎ =	
RX Mode: Auto	▲
Resolution: 200 × 100 dp...	1/2
Hook	R Destination ▼

Enter the fax number with the numeric keys, or select a registered destination.

\* If the machine is connected via Private Branch Exchange (PBX), press [R] before entering the destination with the numeric keys. If [R] is not available, you must register the R-key setting. **▶ [R-Key Setting](P. 438)**

## 5 Configure the original scan settings, as needed. ▶ Fax Original Scan Settings(P. 229)

Send: Press Start	
Destinations: 1	
☎ User-4 1230000000	
RX Mode: Auto	▲
Resolution: 200 × 100 dp...	1/2
Hook	R Destination ▼

## 6 Press .

⇒ Scanning of the original starts.

- To cancel sending of a fax, press [Cancel] ► [Yes]. **▶Canceling Fax Sending(P. 235)**
- When scanning of the original is completed, the fax is sent. Use [Status Monitor] to view the sending status and log. **▶Checking the Status and Log for Sent and Received Faxes(P. 236)**

**■When [Confirm Destination] appears**

Check that the destination is correct, and then press [Start Scan].

**■When [Scan Size] appears**

Select the size of the placed original.

**■When [Scan Next: Press Start] appears**

When an original is placed on the platen glass and scanned, the screen for scanning additional originals is displayed.

To scan additional originals, place them on the platen glass, and press .

When scanning of all documents is completed, press [Start TX].

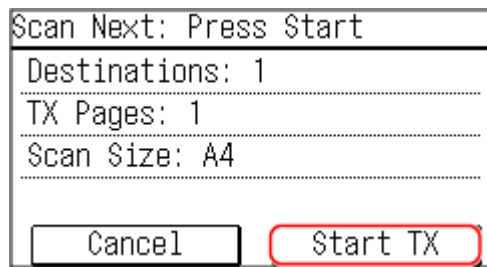

\* If the size of the original is different, part of the image may be missing, or the image may be scanned smaller.

Select the size of the placed original.

# Sending a Fax after a Phone Conversation (Manual Sending)

94WS-068

You can send a fax after a phone conversation. To make a phone call, an external telephone or optional TELEPHONE 6 KIT is required. This section describes how to send a fax after a phone conversation.

When sending a fax during an incoming call, first pick up the handset to answer the call, and then perform the steps below. You do not need to perform Steps 4 and 5 to make a phone call.

## ! IMPORTANT

- The pages that can be scanned and sent for manual sending are restricted as follows:
  - When an original is placed on the feeder, only one side is scanned.
  - When an original is placed on the platen glass, only one page of the placed original can be sent.

### 1 Place the original. ▶ Placing Originals(P. 129)

### 2 On the operation panel, press [Fax] in the [Home] screen. ▶ [Home] Screen(P. 113)

⇒ The fax screen appears.

### 3 Configure the original scan settings, as needed. ▶ Fax Original Scan Settings(P. 229)

Specify destination.		01/11 2022 12:41PM	
☎=			
RX Mode: Auto			▲
Resolution: 200 x 100 dp...			1/2
Hook	☎	Destination	▼

### 4 Pick up the handset.

### 5 Press [Destination], and specify the destination. ▶ Specifying Destinations (Touch Panel Model)(P. 159)

Specify destination.		01/11 2022 12:05PM	
☎=			
Start Receiving			▲
Fax Tone: +1			1/3
End	☎	Destination	▼



Enter the fax number with the numeric keys or select a registered destination to make a phone call.



**6** After the phone conversation, ask the recipient to set their fax machine to receive your fax.

**7** When you hear a beep, press , and hang up the handset.

⇒ Scanning of the original starts.

- To cancel sending of a fax, press [Cancel] ► [Yes].  **Canceling Fax Sending(P. 235)**
- When scanning of the original is completed, the fax is sent. Use [Status Monitor] to view the sending status and log.  **Checking the Status and Log for Sent and Received Faxes(P. 236)**

**■ When [Scan Size] appears**

Select the size of the placed original.

## NOTE

- The destinations and the settings in Manual Sending are not left in the TX Job Log.

# Sending Faxes from a Computer (PC Faxing)

94WS-069

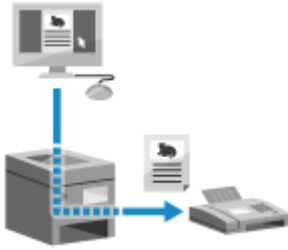

You can send a document as a fax from a computer using a fax driver. As it is easy to send a document, be sure to thoroughly check the item you are sending beforehand. [Securely Sending PC Faxes\(P. 228\)](#)

This section describes the general procedure for this operation. Check the manual of the application you are using for detailed operations on how to use it.

## Required Preparations

- Install the fax driver to the computer and configure the settings according to your usage environment and purpose. [Preparing to Send Faxes from a Computer\(P. 213\)](#)

[When Using Windows\(P. 225\)](#)

[When Using macOS\(P. 226\)](#)

## ■ When Using Windows

- 1** Open the document you are sending on your computer.
- 2** In the application used to open the document, select the command to print.
- 3** Select the fax driver of the machine, and click [Print].

⇒ The [Fax Sending Settings] screen of the fax driver appears.

## 4 Specify a destination.

- This section describes how to enter a fax number. You can specify a destination registered to the Address Book from the [Select Destination] tab.
- If an outside line number is required, enter this number before the fax number. If the outside line number has been set in advance, you do not need to enter it here. [Step 2: Configuring the Settings for Secure Sending\(P. 213\)](#)

### ■ When Entering One Fax Number

On the [Enter Destination] tab, enter a fax number. When [Confirm Fax Number] can be entered, enter the same fax number.

### ■ When Entering Multiple Fax Numbers

- 1 In [Select Destination] tab, click [Add Destination].  
     ⇒ The [Add Destination] screen is displayed.
- 2 Enter the destination name and fax number, and click [Add Next Destination].  
     When [Confirm Fax Number] can be entered, enter the same fax number.
- 3 Repeat Step 2, and after entering all destinations, click [OK].

### 5 Configure the cover sheet, the setting for saving the TX Job Log, and other fax setting, as needed.

- To configure the cover sheet details, click [Cover Sheet].
- To save the TX Job Log to the computer, select the [Store Sent Fax Information and Image] checkbox.
- For more information about the other fax settings, click [Help] on the [Fax Sending Settings] screen to display help.

### 6 Click [Send].

⇒ A screen confirming the send destination is displayed.

### 7 Check that the destination is correct, and click [OK].

- ⇒ The fax is sent via the machine.
- Use [Status Monitor] on the operation panel to view the sending status and log. ▶ **Checking the Status and Log for Sent and Received Faxes(P. 236)**
- When sending a fax with the [Store Sent Fax Information and Image] checkbox selected, you can view the log also from the [Sent Fax Information and Image] tab of the fax driver.

### ■ When Using macOS

#### 1 Open the document you are sending on your computer.

#### 2 In the application used to open the document, click [Print].

⇒ The printing dialog box appears.

**3 In [Printer], select the fax driver of the machine.**

**4 From the print options pop-up menu, select [General Settings].**

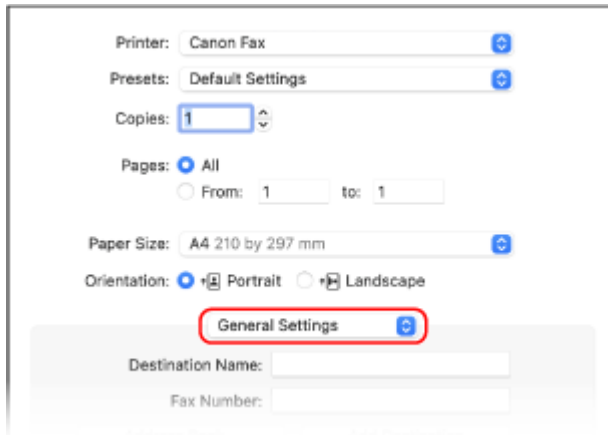

If print options are not displayed, click [Show Details] in the printing dialog box.

**5 Enter the fax number, and click [Add Destination].**

- To specify multiple destinations, repeat this step. You can specify a destination registered to the Address Book from [Address Book].
- If an outside line number is required, enter this number before the fax number.

**6 Configure the cover sheet and other fax settings, as needed.**

- To set the cover sheet details, select [Cover Sheet] from the pop-up menu of the print option.
- For more information about the other fax settings, click [ ? ] in the printing dialog box to display help.

**7 Click [Print].**

⇒ The fax is sent via the machine.

Use [Status Monitor] on the operation panel to view the sending status and log. ▶ **Checking the Status and Log for Sent and Received Faxes(P. 236)**

# Securely Sending PC Faxes

94WS-06A

While sending faxes from a computer can be convenient, there is a risk of sending it to an incorrect number. To reduce this risk, it is recommended that you check the following when sending faxes.

- ▶ **Checking the Content You Are Sending(P. 228)**
- ▶ **Confirming the Destination(P. 228)**
- ▶ **Confirming TX Job Log after Sending(P. 228)**

## Checking the Content You Are Sending

Unlike when scanning a document and sending it, you can only check the content to be sent on the screen of the computer. Therefore, check the content before sending the document.

### Checking with Preview

Check that the content to be sent is as intended. If the paper size is not appropriate, part of the document sticking beyond the paper may be divided and sent separately.

### Checking with PDF

You can convert the document into a PDF and then send it to reduce the risk of sending unintended sheets in an Excel file, for example. When you cannot preview the document with the print function of the application or you want to send only certain pages of the document, you can check the content to be sent before sending.

## Confirming the Destination

You can require the user to enter the fax number twice when specifying a destination or require the user to confirm the destination before sending to reduce the risk of sending a fax to an incorrect destination. For details about the settings to confirm the destination, see the procedures when preparing to send PC faxes. ▶ **Step 2: Configuring the Settings for Secure Sending(P. 213)**

## Confirming TX Job Log after Sending

When the machine is set to save a TX Job Log, you can check the log to confirm whether the intended content was sent correctly. For details about the settings to confirm the TX job log after sending PC faxes, see the procedures when preparing to send PC faxes. ▶ **Step 2: Configuring the Settings for Secure Sending(P. 213)**

# Fax Original Scan Settings

94WS-06C

If the recipient cannot read the text or the sent fax was not as intended, the settings can be adjusted and the fax resent. You can adjust the image quality such as when the fax image is not clear or the text is difficult to read.

Send: Press Start		Destinations: 1	
User-4 1230000000			
RX Mode: Auto		▲	
Resolution: 200 × 100 dp...		1/2	
Hook	R	Destination	▼

## NOTE

### Recalling Past Settings (TX Job Log)

- You can use the TX Job Log to recall the settings used to send faxes in the past. [Specifying Destinations \(TX Job Log\) \(Touch Panel Model\)\(P. 163\)](#)

#### [Resolution]

Select the resolution for scanning originals.

The higher the resolution, the sharper the image, but the longer it takes to send the data.

#### [Density]

Adjust the density to suit the original.

Press [+] to increase the density and [-] to lower it.

#### [2-Sided Original]

Select this according to the top and bottom orientation of the front and back sides of the placed original.

To perform 2-sided scanning, select [Book Type] or [Calendar Type].

#### [Sharpness]

Adjust the sharpness.

Emphasize the contours and lines to make them clearer, or weaken them to make them softer.

#### Adjustment example:

- To make blurry text or shapes clearer**

Press [+].



- To reduce moiré (vertical pattern noise) in photos**

Press [-].

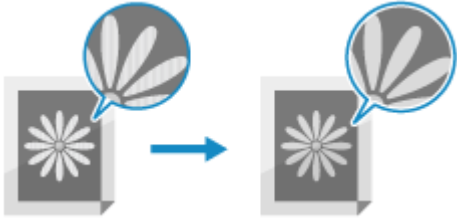

# Receiving Faxes

94WS-06E

When the RX mode is set to receive faxes manually, you must perform operations to receive them. When the RX mode is not set to receive faxes manually, you do not need to perform operations to receive them. When there is an incoming fax, it is automatically received without ringing and then printed once receiving is completed. Place A4 or letter size paper in the paper source to prevent the image from being missing or divided. You can also change the settings to print a received fax on both sides of the paper and print the received date and time and page number. [▶ Changing the Print Settings for Received Faxes\(P. 233\)](#)

## ■ When the Machine Rings

Receive the fax manually.

If a telephone is connected to the machine, you can receive the fax by operating the telephone without operating the machine. [▶ Receiving Faxes via Telephone \(Remote RX\)\(P. 232\)](#)

### 1 When the machine rings, pick up the handset.

If it is a phone call, you can take the call.

### 2 If you hear a beep, on the operation panel, press [Fax] in the [Home] screen. [▶ \[Home\] Screen\(P. 113\)](#)

⇒ The fax screen appears.

### 3 Press [Start Receiving], and hang up the handset.

⇒ The machine starts receiving the fax. When receiving is completed, the fax is printed automatically.

## NOTE

### When a Fax Is Not Received or Printed

[▶ Cannot Receive a Fax\(P. 549\)](#)

### To Not Print a Received Fax

- Save the received fax to the memory of the machine or forward it to a specific destination.
  - [▶ Saving Received Documents in the Machine \(Memory Lock\) \(Touch Panel Model\)\(P. 331\)](#)
  - [▶ Auto Forwarding and Backing Up Received Faxes\(P. 219\)](#)



## Receiving Faxes via Telephone (Remote RX)

---

94WS-06F

Remote RX allows you to use the numeric keys of the telephone connected to the machine to receive faxes by dialing a predetermined number (Remote RX ID).

The Remote RX ID is set to [25] by default. You can change this to a custom number.  **[Remote RX](P. 445)**

### **1 When the machine rings, pick up the handset of the telephone.**

If it is a phone call, you can take the call.

### **2 When you hear a beep, dial the Remote RX ID using the numeric keys of the telephone.**

▣ The machine starts receiving the fax. When receiving is completed, the fax is printed automatically.

If you do not hear a set of tones when entering the Remote RX ID, press the tone button (\*) of the telephone, and then enter the Remote RX ID again.

### **3 Hang up the handset.**

# Changing the Print Settings for Received Faxes

94WS-06H

Received faxes are printed on one side of the paper by default. You can change the settings to print on both sides of the paper, and print the received date and time and page number.

- ▶ **Printing on Both Sides(P. 233)**
- ▶ **Printing the Received Date and Time and Page Number(P. 233)**

## Printing on Both Sides

This section describes how to configure the settings using Remote UI from a computer. On the operation panel, select [Menu] in the [Home] screen, and then select [Function Settings] to configure the settings. ▶ **[Print on Both Sides](P. 444)**  
Administrator privileges are required.

- 1 Log in to Remote UI in System Manager Mode.** ▶ **Starting Remote UI(P. 349)**
- 2 On the Portal page of Remote UI, click [Settings/Registration].** ▶ **Portal Page of Remote UI(P. 351)**
- 3 Click [RX/Forwarding Settings] ▶ [Fax RX Settings] ▶ [Edit] in [Basic Settings].**  
 ▶ The [Edit Basic Settings] screen is displayed.
- 4 Select the [Print on Both Sides] checkbox.**
- 5 Click [OK].**  
 ▶ The settings are applied.
- 6 Log out from Remote UI.**

## Printing the Received Date and Time and Page Number

Select whether to print the following information at the bottom of received faxes:

- Reception date and time
- Received reception number
- Page number

This section describes how to configure the settings using Remote UI from a computer. On the operation panel, select [Menu] in the [Home] screen, and then select [Function Settings] to configure the settings. ▶ **[Print RX Page Footer](P. 443)**  
Administrator privileges are required.

- 1 Log in to Remote UI in System Manager Mode. ▶ Starting Remote UI(P. 349)**
- 2 On the Portal page of Remote UI, click [Settings/Registration]. ▶ Portal Page of Remote UI(P. 351)**
- 3 Click [RX/Forwarding Settings] ▶ [Common Settings] ▶ [Edit] in [Common Settings].**
  - ▶▶ The [Edit Common Settings] screen is displayed.
- 4 Select the [Add RX Page Footer] checkbox.**
- 5 Click [OK].**
  - ▶▶ The settings are applied.
- 6 Log out from Remote UI.**

## Canceling Fax Sending

You can cancel sending of a fax by following the on-screen instructions.

Press **[Cancel]** ► **[Yes]**.

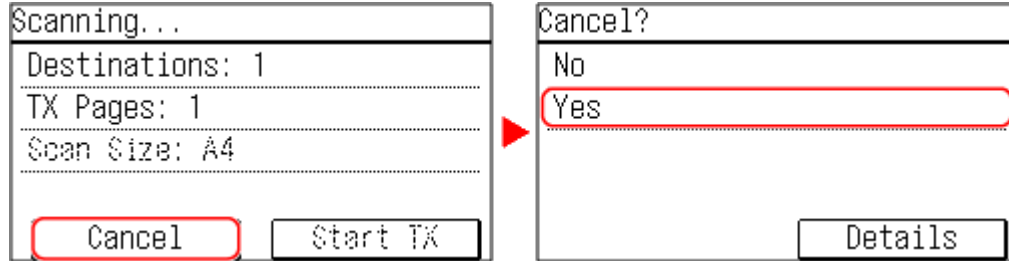

If the above screen is not displayed, press  on the operation panel, and then press **[Yes]**.

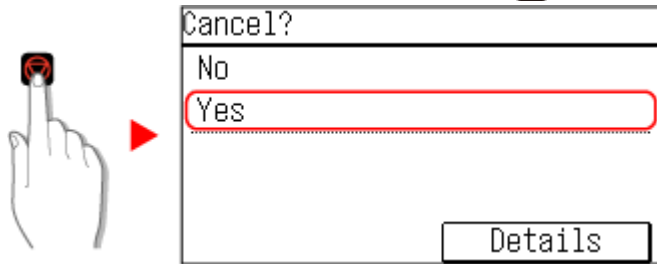

If a job list screen is displayed, select the job to cancel, and press **[Yes]**.

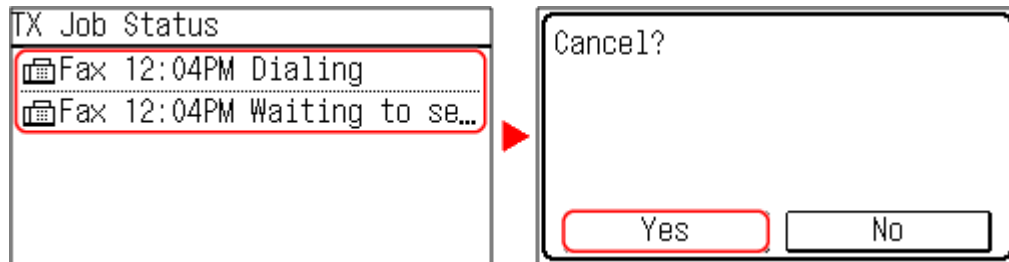

# Checking the Status and Log for Sent and Received Faxes

94WS-06K

Processes handled by the machine, including sending and receiving faxes, are managed as jobs. By checking the status and log of jobs, you can determine whether a job was sent or received correctly and the cause of errors that occur.

When the settings are configured to save faxes that could not be forwarded, these faxes can be printed on the machine or forwarded to a different destination instead.

\* If the log is set to not be displayed, you can only check the send and receive status. ▶[Display Job Log](P. 453)

▶Checking Sent and Received Faxes(P. 236)

▶Checking Faxes that Failed to Be Forwarded(P. 237)

## Checking Sent and Received Faxes

You can check the status and log of sent and received faxes.

You can also check the number of pages of the fax and the fax numbers of the destination and sender, and forward faxes waiting to be received and printed.

This section describes how to check the status and log using the operation panel.

You can also use Remote UI from a computer to check the status and log. To print faxes saved in the memory, use Remote UI. ▶Checking Usage and Logs with Remote UI(P. 353)

### 1 On the operation panel, press . ▶Operation Panel(P. 14)

⇒ The [Status Monitor] screen is displayed.

### 2 Press [TX Job] or [RX Job].

### 3 Check the status and log.

#### ■When Checking the Status of Sent and Received Faxes

##### 1 Press [Job Status].

- You can check the jobs being processed or waiting to be processed.
- Faxes saved in the memory are displayed in the as [Waiting to print].

##### 2 Select a job to view its details.

⇒ The job details are displayed.

##### 3 View the number of pages, the fax numbers of the destination and sender, and other information.

- When there are multiple fax destinations, press [Destination:] to display them in a list.
- Press [Forward] to forward faxes waiting to be received or printed to a destination registered in the Address Book. You cannot forward faxes being received or printed.

#### ■When Checking the Log of Sent and Received Faxes

##### 1 Press [Job Log].

You can check the completed sent and received jobs.

- 2 Select a job to view its details.
  - ⇒ The job details are displayed.
- 3 View the number of pages and the fax numbers of the destination and sender. When there are multiple fax destinations, press [Destination:] to display them in a list.

#### When the TX/RX Job Log displays [Error]

Sending or receiving was canceled, or an error occurred.

If a three-digit number starting with "#" (error code) is displayed, you can check the cause and solution using the error code. ▶ **An Error Code Is Displayed(P. 575)**

## NOTE

### Registering Destinations to the Address Book

- On the screen displaying the job details, press [Reg Adr Book] to register the destination to the Address Book.
- \* This operation is not available when there are multiple destinations.

## Checking Faxes that Failed to Be Forwarded

If a fax could not be forwarded but remains in the memory, you can print it or forward it to a different destination, and view its content.

This section describes how to check the fax content using the operation panel.

You can also use Remote UI from a computer to check the fax content. To preview the fax content, use the Remote UI.

▶ **Checking Usage and Logs with Remote UI(P. 353)**

### Required Preparations

- Configure the settings to save faxes that could not be forwarded in the memory of the machine. ▶ **Auto Forwarding and Backing Up Received Faxes(P. 219)**

## 1 On the operation panel, press . ▶ **Operation Panel(P. 14)**

⇒ The [Status Monitor] screen is displayed.

## 2 Press [Fax Forwarding Errors].

⇒ A list of jobs of faxes that could not be forwarded is displayed.

## 3 Select a job you want to check.

⇒ The job details are displayed.

## 4 Print or forward the fax to a different destination, and view the fax content.

- To print with the machine, press [Print/Fwd] ▶ [Print] ▶ [Yes].
- To send or save the fax to a destination different from the one set as the forwarding destination, press [Print/Fwd] ▶ [Forward], select the checkbox of a destination registered in the Address Book, and press [Yes].

# Copying

<b>Copying</b> .....	239
<b>Copy Operations</b> .....	240
<b>Additional Copying Features (Touch Panel Model)</b> .....	244
<b>Additional Copying Features (5 Lines LCD Model)</b> .....	250
<b>Using Paper Save Copy</b> .....	256
<b>Copying Both Sides of ID Cards onto One Sheet</b> .....	260
<b>Copying Multiple Passports onto One Sheet</b> .....	264
<b>Canceling Copy Operations</b> .....	268
<b>Checking the Copy Status</b> .....	270

# Copying

94WS-06L

You can easily copy documents, photos, and other printed materials ("originals") using the copy function of the machine. In addition to basic copy settings, the machine also has settings for copying according to your original and purpose. Configure these settings when copying for more efficient operations and to save paper.

## Basic Copy Operations

You can set the copy ratio (for enlarging or reducing), number of copies, and other basic settings.

▶ **Copy Operations(P. 240)**

## Copying According to Your Original and Purpose

You can perform 2-sided copying and adjust the image quality and other settings to suit your original and purpose.

▶ **Additional Copying Features (Touch Panel Model)(P. 244)**

▶ **Additional Copying Features (5 Lines LCD Model)(P. 250)**

This allows you to quickly make copies using a combination of N on 1 and 2-sided copying from the [Home] screen on the operation panel.

▶ **Using Paper Save Copy(P. 256)**

## Copying for Specific Operations

The ID Card Copy function can be quickly performed from  on the operation panel or from the [Home] screen, and the Passport Copy function can be quickly performed from the [Home] screen.

### ID Card Copy



Copies the front and back sides of a driver's license or other ID card on the same sheet of paper at 100% magnification. This is convenient, for example, when copying ID cards at reception.

▶ **Copying Both Sides of ID Cards onto One Sheet(P. 260)**

### Passport Copy



Copies multiple passports together onto one sheet of paper.

▶ **Copying Multiple Passports onto One Sheet(P. 264)**

## ■ See Also

### When Results Are Not as Expected

If print results are too dark or too faint, adjust the print density.

▶ **Adjusting the Print Density(P. 480)**



# Copy Operations

94WS-06R

This section describes the basic copy operations when copying documents, photos, and other printed materials ("originals").

## ! IMPORTANT

- When copying originals that have text or images extending to the edges without margins, the copy may be printed with an area missing around the edge. For the size of the margin, see the basic specifications. [▶ Basic Specifications\(P. 24\)](#)

[▶ Touch Panel Model\(P. 240\)](#)

[▶ 5 Lines LCD Model\(P. 241\)](#)

## Touch Panel Model

**1** Place the original. [▶ Placing Originals\(P. 129\)](#)

**2** On the operation panel, press [Copy] in the [Home] screen. [▶ \[Home\] Screen\(P. 113\)](#)

⇒ The copy screen is displayed.

**3** Set the Number of Copies, and Copy Ratio.

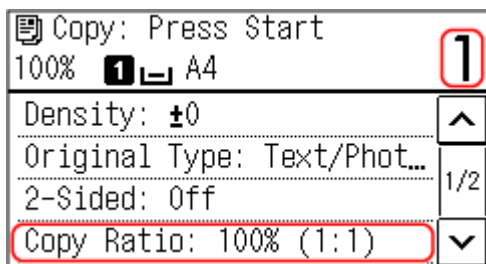

### [Number of Copies]

Specify the number of copies.  
Use the numeric keys to enter the number of copies.

### [Copy Ratio]

Set the ratio for enlarging or reducing copies.

#### Setting a Custom Copy Ratio

Press [Custom Ratio], enter a custom ratio using the numeric keys, or press  $\uparrow$  /  $\downarrow$ , and then press [Apply].

You can specify a value from 25% to 400% in 1% increments.

#### Automatically Setting the Copy Ratio for a Standard Size

Select a fixed copy ratio from the list.

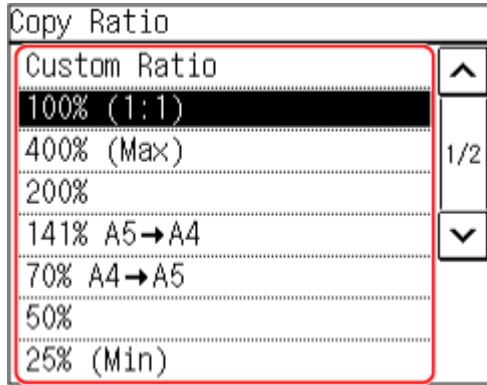

#### 4 Configure the other copy settings, as needed. **▶ Additional Copying Features (Touch Panel Model)(P. 244)**

You can perform 2-sided copying and adjust the image quality and other settings to suit your original and purpose.

#### 5 Press .

⇒ Copying starts.

- To cancel copying, press [Cancel] ▶ [Yes]. **▶ Canceling Copy Operations(P. 268)**
- Use [Status Monitor] to view the copy job status. **▶ Checking the Copy Status(P. 270)**

#### ■ When [Scan Next: Press Start] appears

When an original is placed on the platen glass and copied using 2-sided copying, N on1 or collate, the screen is displayed for scanning the next original.

- 1 Select the original size.  
Only displayed when 2-sided copying is specified.
- 2 Place the next original on the platen glass, and press .

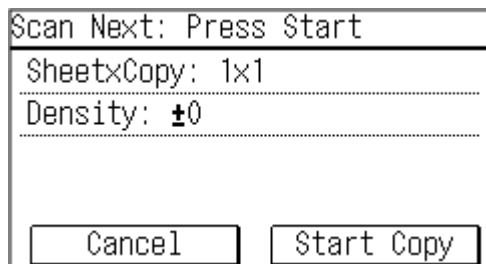

⇒ The next original is scanned, and the same screen is displayed.  
Repeat this process until scanning of all originals is completed.

- You can also press [Density] to change the settings for each original.
- If the size of the original is different, part of the image may be missing, or the image may be printed smaller on the paper.

- 3 Press [Start Copy].

⇒ The scanned originals are printed.

## 5 Lines LCD Model

### 1 Place the original. **▶ Placing Originals(P. 129)**

**2 On the operation panel, press [Copy] ► **OK** in the [Home] screen. **▶[Home] Screen(P. 113)****

⇒ The copy screen is displayed.

**3 Set the Number of Copies, and Copy Ratio.**

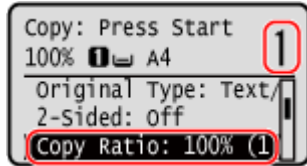

**[Number of Copies]**

Specify the number of copies.

Use ▲ / ▼, or the numeric keys to enter the number of copies, and then press **OK**.

**[Copy Ratio]**

Set the ratio for enlarging or reducing copies.

**Setting a Custom Copy Ratio**

Press [Custom Ratio], enter a custom ratio using the numeric keys, and then press [Apply]. You can specify a value from 25% to 400% in 1% increments.

**Automatically Setting the Copy Ratio for a Standard Size**

Select a fixed copy ratio from the list, and press **OK**.

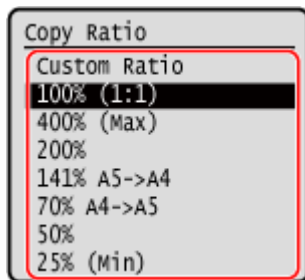

**4 Configure the other copy settings, as needed. **▶Additional Copying Features (5 Lines LCD Model)(P. 250)****

You can perform 2-sided copying and adjust the image quality and other settings to suit your original and purpose.

**5 Press **OK**.**

⇒ Copying starts.

- To cancel copying, press [Cancel] ► **OK** ► [Yes] ► **OK**. **▶Canceling Copy Operations(P. 268)**
- Use [Status Monitor] to view the copy job status. **▶Checking the Copy Status(P. 270)**

**■When [Scan Next: Press Start] appears**

When an original is placed on the platen glass and copied using 2-sided copying or N on 1, the screen is displayed for scanning the next original.

- 1 Select original size.  
Only displayed when 2-sided copying is specified.

- 2 Place the next original on the platen glass, and press .

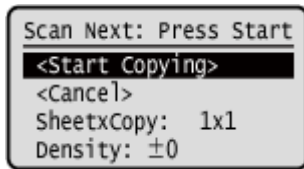

- ▣ The next original is scanned, and the same screen is displayed.  
Repeat this process until scanning of all originals is completed.
- You can also press [Density] ►  to change the settings for each original.
- If the size of the original is different, part of the image may be missing, or the image may be printed smaller on the paper.

- 3 Press [<Start Copying>] ► .

- ▣ The scanned originals are printed.

## Additional Copying Features (Touch Panel Model)

94WS-06S

In addition to basic copy settings, the machine also has settings for 2-sided copying, image quality adjustment, and other settings according to your original and purpose. Use the copy screen to configure these settings.

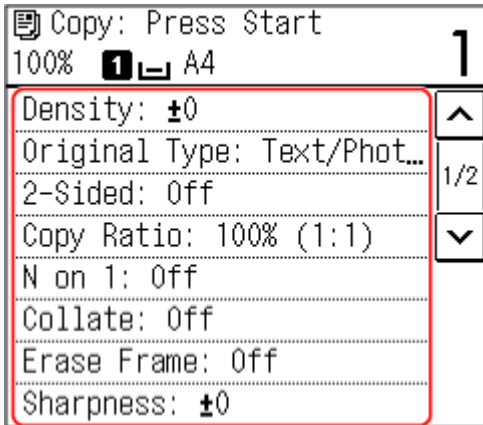

\* To make copies using the ID Card Copy function, you can simply adjust the density and image quality.

- ▶ **Making 2-sided Copies(P. 244)**
- ▶ **Copying Multiple Originals onto One Sheet (N on 1)(P. 245)**
- ▶ **Collating Copies by Page (Collate)(P. 246)**
- ▶ **Adjusting the Density(P. 247)**
- ▶ **Adjusting the Image Quality(P. 247)**

### NOTE

#### Changing the Default Settings

- You can also change the default copy settings. ▶ **Changing the Default Settings(P. 165)**

#### Basic Copy Operations

- For the basic operations when copying, see the following:  
▶ **Copy Operations(P. 240)**

## Making 2-sided Copies

You can copy two 1-sided originals on both sides of one sheet of paper.

\* 2-sided copying may not be available with some sizes and types of paper. ▶ **Usable Paper(P. 19)**

### 1 Press [2-Sided] on the copy screen.

⇒ The [2-Sided] screen reappears.

### 2 Press [1->2-Sided].

⇒ The copy screen reappears.

### 3 Set the original orientation and finishing Type, as needed.

- 1 Press [2-Sided] on the copy screen.  
 ⇒ The [2-Sided] screen is displayed.
- 2 Press [Original/Finishing Type].  
 ⇒ The [Orig./Finishing Type] screen is displayed.

- 3 Select the original orientation.

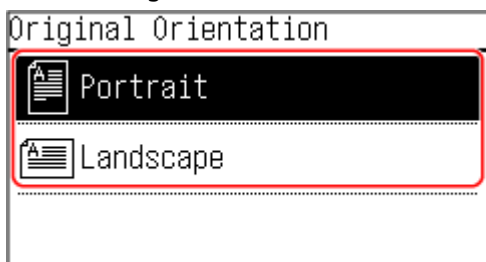

⇒ The [Finishing Type] screen is displayed.

- 4 Select the finishing type.

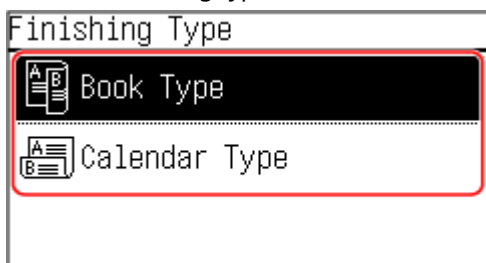

⇒ The copy screen reappears.

## Copying Multiple Originals onto One Sheet (N on 1)

You can reduce the size of a multiple-page original and arrange the pages on one sheet of paper when copying. N on 1 is convenient when you want to save paper by copying on fewer sheets of paper than the original.

\* This cannot be set at the same time as Erase Frame.

- 1 Press [N on 1] on the copy screen.

⇒ The [N on 1] screen is displayed.

- 2 Select the number of pages to combined.

[Off]

Pages are not combined.

[2 on 1]

Combines a 2-page original onto one sheet of paper.

[4 on 1]

Combines a 4-page original onto one sheet of paper.

- 3 Select the size of the placed original.

⇒ The copy screen reappears.

## 4 Configure the layout (page order) when combining originals, as needed.

- 1 Press [N on 1].  
 ⇒ The [N on 1] screen is displayed.
- 2 Press [Select Layout].  
 ⇒ The [Select Layout] screen is displayed.
- 3 Select the page order.  
 ⇒ The [Scan Size] screen is displayed.
- 4 Select the size of the placed original.  
 ⇒ The copy screen reappears.

### NOTE

- When combining pages, the copy ratio is set automatically according to the following. You can also change the copy ratio setting manually.
  - Number of pages to be combined
  - Original size setting
  - Size of paper used for copying
- When pages are combined, a margin may be created around the copied images.

## Collating Copies by Page (Collate)

When copying multiple copies of a multi-page original, you can collate the copies in the page order of the original. This is convenient when copying handouts for meetings.

### When Copying without Collating

The copies are grouped by the page of the original in the number of specified copies and not collated. For example, when you are making three copies of a three-page original, the printouts are arranged in the following order: 1, 1, 1, 2, 2, 2, 3, 3, 3.



### When Copying with Collating

The copies are collated into sets in the page order of the original. For example, when you are making three copies of a three-page original, the printouts are arranged in the following order: 1, 2, 3, 1, 2, 3, 1, 2, 3.

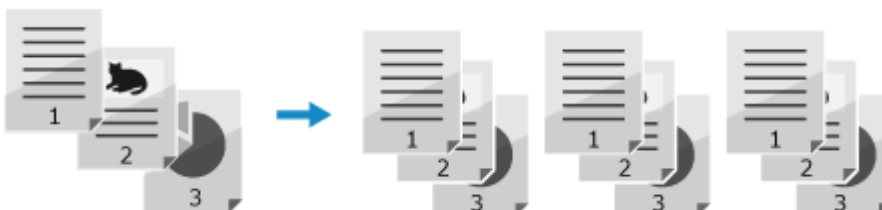

## 1 Press [Collate] on the copy screen.

⇒ The [Collate] screen is displayed.

## 2 Press [On].

⇒ The copy screen reappears.

## Adjusting the Density

You can adjust the density to suit the original when copying.

If text or images in the original are too faint or dark, adjust the density of the entire original.

To create clean copies of an original with a colored background or a newspaper, adjust the density of the background.

## 1 Press [Density] on the copy screen.

⇒ The [Density] screen is displayed.

## 2 Adjust the density.

### ■ Adjusting the Density of the Entire Original

Drag the slider to the left or right to adjust the density, and press [Apply].

Press [+] to increase the density and [-] to lower it.

### ■ Adjusting the Density of the Background

#### 1 Press [Background].

⇒ The [Background] screen is displayed.

#### 2 Select the adjustment method and press [Apply].

##### [Auto]

An optimal density for the original is automatically set.

[Original Type] is automatically set to [Text].

##### [Adjust (Manual)]

Drag the slider to the left or right to adjust the density, and press the [Apply].

Press [+] to increase the density and [-] to lower it.

## NOTE

- When you adjust the density of the background, parts other than the background may also be affected.

## Adjusting the Image Quality

You can adjust the image quality such as when the copied image is not clear or the text is difficult to read. You can also erase dark borders and shadows that appear around the edges of the original when copying.

\* Erase Frame is not available when making copies using the ID Card Copy function.



## ■ Selecting the Image Quality for the Original Type

### 1 Press [Original Type] on the copy screen.

⇒ The [Original Type] screen is displayed.

### 2 Select the original type.

⇒ The copy screen reappears.

#### ■ When Copying Originals with Both Text and Photos

Select [Text/Photo (High Speed)] or [Text/Photo (Quality)].

##### **Giving Priority to Speed over Image Quality**

Place the original in the feeder, and select [Text/Photo (High Speed)].

##### **Giving Priority to Image Quality over Speed**

Select [Text/Photo (Quality)], adjust to make text or photos more visible, and press [Apply].

#### ■ Copying Photos Containing Halftone Dots such as in Magazines

Select [Photo].

#### ■ Copying Originals with Large Volumes of Text such as Research Papers

Select [Text].

## ■ Erasing Dark Borders and Shadows around Edges of the Original (Erase Frame)

This function erases the dark borders and shadows that appear around the edges in the copied image when copying originals that are smaller than the paper size or thick originals.

\* This cannot be set at the same time as N on 1.

### 1 Press [Erase Frame] on the copy screen.

⇒ The [Erase Frame] screen is displayed.

### 2 Press [On].

⇒ The screen for specifying the frame width to erase is displayed.

### 3 Enter the frame width to erase, and press [Apply].

⇒ The [Scan Size] screen is displayed.

When you are copying at an enlarged or reduced size, the function automatically changes the size of the frame width to erase to match the copy ratio setting.

### 4 Select the size of the placed original.

⇒ The copy screen reappears.

## ■ Adjusting the Sharpness

You can emphasize the contours and lines to make them clearer in the copied image, or weaken them to make them softer.

### 1 Press [Sharpness] on the copy screen.

⇒ The [Sharpness] screen is displayed.

### 2 Drag the slider to the left or right to adjust the sharpness.

#### Adjustment example:

- To Make Blurry Text or Shapes Clearer

Press [+].

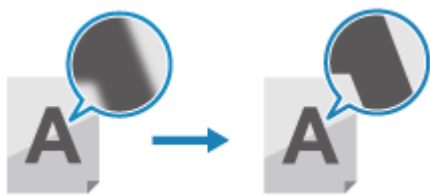

- To reduce moiré (vertical pattern noise) in photos

Press [-].

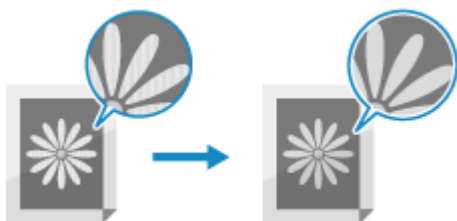

### 3 Press [Apply].

⇒ The copy screen reappears.

## Additional Copying Features (5 Lines LCD Model)

94WS-06U

In addition to basic copy settings, the machine also has settings for 2-sided copying, image quality adjustment, and other settings according to your original and purpose. Use the copy screen to configure these settings.

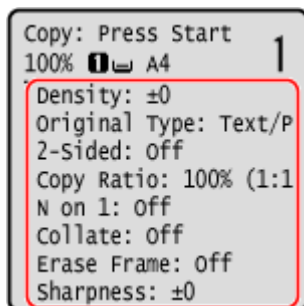

\* To make copies using the ID Card Copy function, you can simply adjust the density and image quality.

- ▶ **Making 2-sided Copies(P. 250)**
- ▶ **Copying Multiple Originals onto One Sheet (N on 1)(P. 251)**
- ▶ **Collating Copies by Page (Collate)(P. 252)**
- ▶ **Adjusting the Density(P. 253)**
- ▶ **Adjusting the Image Quality(P. 253)**

### NOTE

#### Changing the Default Settings

- You can also change the default copy settings. ▶ **Changing the Default Settings(P. 165)**

#### Basic Copy Operations

- For the basic operations when copying, see the following:
  - ▶ **Copy Operations(P. 240)**

## Making 2-sided Copies

You can copy two 1-sided originals on both sides of one sheet of paper.

\* 2-sided copying may not be available with some sizes and types of paper. ▶ **Usable Paper(P. 19)**

### 1 Press [2-Sided] on the copy screen ▶ **OK**.

⇒ The [2-Sided] screen reappears.

### 2 Press [1->2-Sided] ▶ **OK**.

⇒ The copy screen reappears.

### 3 Set the original orientation and finishing Type, as needed.

- 1 Press [2-Sided] on the copy screen ▶ **OK**.

⇒ The [2-Sided] screen is displayed.

- 2 Press [Original/Finishing Type] ▶ **OK**.

⇒ The [Orig./Finishing Type] screen is displayed.

- 3 Select the original orientation ▶ **OK**.

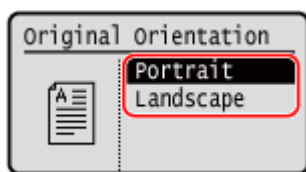

⇒ The [Finishing Type] screen is displayed.

- 4 Select the finishing type ▶ **OK**.

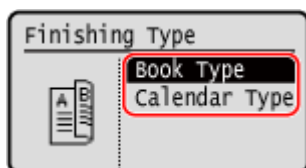

⇒ The copy screen reappears.

## Copying Multiple Originals onto One Sheet (N on 1)

You can reduce the size of a multiple-page original and arrange the pages on one sheet of paper when copying. N on 1 is convenient when you want to save paper by copying on fewer sheets of paper than the original.

\* This cannot be set at the same time as Erase Frame.

- 1 Press [N on 1] on the copy screen ▶ **OK**.

⇒ The [N on 1] screen is displayed.

- 2 Select the number of pages to combined ▶ **OK**.

**[Off]**

Pages are not combined.

**[2 on 1]**

Combines a 2-page original onto one sheet of paper.

**[4 on 1]**

Combines a 4-page original onto one sheet of paper.

- 3 Select the size of the placed original ▶ **OK**.

⇒ The copy screen reappears.

- 4 Configure the layout (page order) when combining originals, as needed.

- 1 Press [N on 1] ▶ **OK**

⇒ The [N on 1] screen is displayed.

- 2 Press [Select Layout] ► **OK**.  
 ► The [Select Layout] screen is displayed.
- 3 Select the page order, and press **OK**.  
 ► The [Scan Size] screen is displayed.
- 4 Select the size of the placed original, and press **OK**.  
 ► The copy screen reappears.

## NOTE

- When combining pages, the copy ratio is set automatically according to the following. You can also change the copy ratio setting manually.
  - Number of pages to be combined
  - Original size setting
  - Size of paper used for copying
- When pages are combined, a margin may be created around the copied images.

## Collating Copies by Page (Collate)

When copying multiple copies of a multi-page original, you can collate the copies in the page order of the original. This is convenient when copying handouts for meetings.

### When Copying without Collating

The copies are grouped by the page of the original in the number of specified copies and not collated. For example, when you are making three copies of a three-page original, the printouts are arranged in the following order: 1, 1, 1, 2, 2, 2, 3, 3, 3.

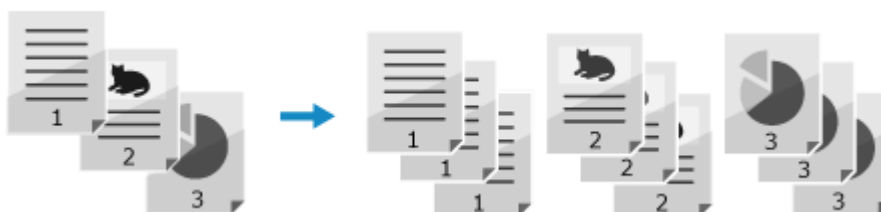

### When Copying with Collating

The copies are collated into sets in the page order of the original. For example, when you are making three copies of a three-page original, the printouts are arranged in the following order: 1, 2, 3, 1, 2, 3, 1, 2, 3.

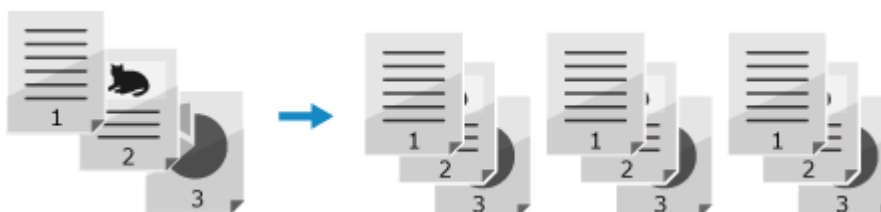

- 1 Press [Collate] on the copy screen ► **OK**.

► The [Collate] screen is displayed.

## 2 Press [On] ▶ .

⇒ The copy screen reappears.

## Adjusting the Density

You can adjust the density to suit the original when copying.

If text or images in the original are too faint or dark, adjust the density of the entire original.

To create clean copies of an original with a colored background or a newspaper, adjust the density of the background.

### 1 Press [Density] on the copy screen ▶ .

⇒ The [Density] screen is displayed.

### 2 Adjust the density.

#### ■ Adjusting the Density of the Entire Original

Select [Density], move the slider to the left or right to adjust the density, and press .

Set [+] to increase the density and [-] to lower it.

#### ■ Adjusting the Density of the Background

##### 1 Press [Background] ▶ .

⇒ The [Background] screen is displayed.

##### 2 Select the adjustment method, and press .

###### [Auto]

An optimal density for the original is automatically set.

[Original Type] is automatically set to [Text].

###### [Adjust (Manual)]

Drag the slider to the left or right to adjust the density, and press .

Press [+] to increase the density and [-] to lower it.

## NOTE

- When you adjust the density of the background, parts other than the background may also be affected.

## Adjusting the Image Quality

You can adjust the image quality such as when the copied image is not clear or the text is difficult to read. You can also erase dark borders and shadows that appear around the edges of the original when copying.

\* Erase Frame is not available when making copies using the ID Card Copy function.

## ■ Selecting the Image Quality for the Original Type

### 1 Press [Original Type] on the copy screen ▶ **OK**.

⇒ The [Original Type] screen is displayed.

### 2 Select the original type, and press ▶ **OK**.

⇒ The copy screen reappears.

#### ■ When Copying Originals with Both Text and Photos

Select [Text/Photo (High Speed)] or [Text/Photo (Quality)].

##### Giving Priority to Speed over Image Quality

Place the original in the feeder, and select [Text/Photo (High Speed)].

##### Giving Priority to Image Quality over Speed

Press [Text/Photo (Quality)] ▶ **OK**, adjust to make text or photos more visible, and press **OK**.

#### ■ Copying Photos Containing Halftone Dots such as in Magazines

Select [Photo].

#### ■ Copying Originals with Large Volumes of Text such as Research Papers

Select [Text].

## ■ Erasing Dark Borders and Shadows around Edges of the Original (Erase Frame)

This function erases the dark borders and shadows that appear around the edges in the copied image when copying originals that are smaller than the paper size or thick originals.

\* This cannot be set at the same time as N on 1.

### 1 Press [Erase Frame] on the copy screen ▶ **OK**.

⇒ The [Erase Frame] screen is displayed.

### 2 Press [On] ▶ **OK**.

⇒ The screen for specifying the frame width to erase is displayed.

### 3 Enter the frame width to erase, and press **OK**.

⇒ The [Scan Size] screen is displayed.

When you are copying at an enlarged or reduced size, the function automatically changes the size of the frame width to erase to match the copy ratio setting.

### 4 Select the size of the placed original.

⇒ The copy screen reappears.

## ■ Adjusting the Sharpness

You can emphasize the contours and lines to make them clearer in the copied image, or weaken them to make them softer.

### 1 Press [Sharpness] on the copy screen ▶ **OK**.

⇒ The [Sharpness] screen is displayed.

### 2 Move the slider to the left or right to adjust the sharpness.

#### Adjustment example:

- To Make Blurry Text or Shapes Clearer

Press [+].

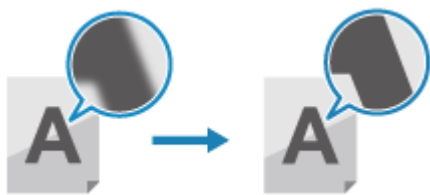

- To reduce moiré (vertical pattern noise) in photos

Press [-].

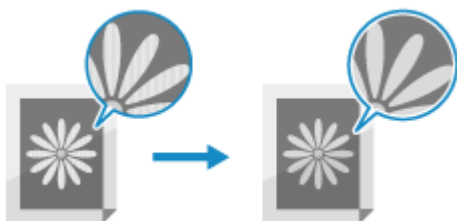

### 3 Press **OK**.

⇒ The copy screen reappears.



## Using Paper Save Copy

Use the Paper Save Copy function to copy a multi-page original onto fewer sheets of paper than the original. This allows you to quickly make copies using a combination of N on 1 and 2-sided copying from the [Home] screen on the operation panel.

- ▶ **Touch Panel Model(P. 256)**
- ▶ **5 Lines LCD Model(P. 257)**

### Touch Panel Model

- 1 Place the original.** ▶ **Placing Originals(P. 129)**
  
- 2 On the operation panel, press [Paper Save] in the [Home] screen.** ▶ **[Home] Screen(P. 113)**
  - ⇒ The [Paper Save Copy] screen is displayed.
  
- 3 Select a combination of the number of pages to be combined and whether to use 2-sided copying.**
  - [2 on 1 1->2-Sided]**  
Combine a 2-page original onto one side of a sheet of paper using 2-sided copying.
  - [4 on 1 1->2-Sided]**  
Combine a 4-page original onto one side of a sheet of paper using 2-sided copying.
  - [2 on 1 1->1-Sided]**  
Combine a 2-page original onto one side of a sheet of paper using 1-sided copying.
  - [4 on 1 1->1-Sided]**  
Combine a 4-page original onto one side of a sheet of paper using 1-sided copying.
  
- 4 Select the size of the placed original.**
  - ⇒ The copy screen is displayed.
  
- 5 Set the number of copies.**

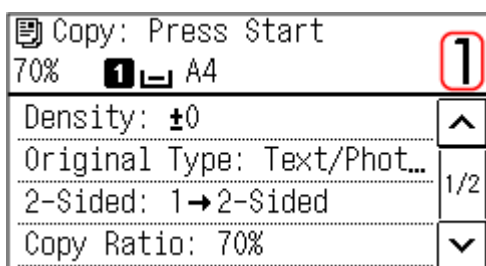

Use the numeric keys to enter the number of copies.

\* When you use Paper Save to make copies, the copy ratio is set automatically according to the paper size used for copying and the number of pages being combined. You can also press [Copy Ratio] to manually change the copy ratio.

## 6 Configure the other copy settings, as needed. ▶ Additional Copying Features (Touch Panel Model)(P. 244)

- You can adjust the density and image quality.
- You can change the number of pages to be combined and the 2-sided copy settings selected in 3.

## 7 Press .

⇒ Copying starts.

- To cancel copying, press [Cancel] ▶ [Yes]. ▶ **Canceling Copy Operations(P. 268)**
- Use [Status Monitor] to view the copy job status. ▶ **Viewing the Print Job Status and Log(P. 190)**

### ■ When [Scan Next: Press Start] appears

When an original is placed on the platen glass and copied using 2-sided copying, N on1 or collate, the screen is displayed for scanning the next original.

- 1 Select the paper size.  
Only displayed when 2-sided copying is specified.
- 2 Place the next original on the platen glass, and press .

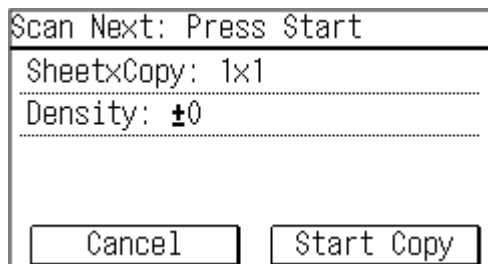

⇒ The next original is scanned, and the same screen is displayed.  
Repeat this process until scanning of all originals is completed.

- You can also press [Density] to change the settings for each original.
- If the size of the original is different, part of the image may be missing, or the image may be printed smaller on the paper.

- 3 Press [Start Copy].  
⇒ The scanned originals are printed.

## 5 Lines LCD Model

### 1 Place the original. ▶ Placing Originals(P. 129)

### 2 On the operation panel, press [Paper Save Copy] ▶ in the [Home] screen. ▶ [Home] Screen(P. 113)

⇒ The [Paper Save Copy] screen is displayed.

### 3 Select a combination of the number of pages to be combined and whether to use 2-sided copying, and Press **OK**.

#### [2 on 1 1->2-Sided]

Combine a 2-page original onto one side of a sheet of paper using 2-sided copying.

#### [4 on 1 1->2-Sided]

Combine a 4-page original onto one side of a sheet of paper using 2-sided copying.

#### [2 on 1 1->1-Sided]

Combine a 2-page original onto one side of a sheet of paper using 1-sided copying.

#### [4 on 1 1->1-Sided]

Combine a 4-page original onto one side of a sheet of paper using 1-sided copying.

### 4 Select the size of the placed original, and press **OK**.

⇒ The copy screen is displayed.

### 5 Set the number of copies.

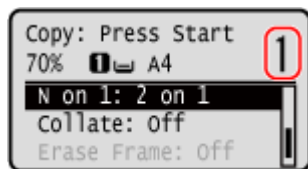

Press **▲** / **▼** ▶ [Number of Copies] ▶ **OK**, set the number of copies, and then press **OK**.

\* When you use Paper Save to make copies, the copy ratio is set automatically according to the paper size used for copying and the number of pages being combined. You can also press [Copy Ratio] to manually change the copy ratio.

### 6 Configure the other copy settings, as needed. ▶ **Additional Copying Features (5 Lines LCD Model)(P. 250)**

- You can adjust the density and image quality.
- You can change the number of pages to be combined and the 2-sided copy settings selected in 3.

### 7 Press **▶**.

⇒ Copying starts.

- To cancel copying, press [Cancel] ▶ **OK** ▶ [Yes] ▶ **OK**. ▶ **Canceling Copy Operations(P. 268)**
- Use [Status Monitor] to view the copy job status. ▶ **Viewing the Print Job Status and Log(P. 190)**

#### ■ **When [Scan Next: Press Start] appears**

When an original is placed on the platen glass and copied using 2-sided copying or N on 1, the screen is displayed for scanning the next original.

- 1 Select the Paper size.  
Only displayed when 2-sided copying is specified.
- 2 Place the next original on the platen glass, and press **▶**.

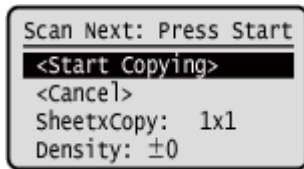

⇒ The next original is scanned, and the same screen is displayed.  
Repeat this process until scanning of all originals is completed.

- You can also press [Density] ► **OK**, to change the settings for each original.
- If the size of the original is different, part of the image may be missing, or the image may be printed smaller on the paper.

**3** Press [<Start Copying>] ► **OK**.

⇒ The scanned originals are printed.

## NOTE

- When pages are combined, a margin may be created around the copied images.

## Copying Both Sides of ID Cards onto One Sheet

94WS-06X



You can use the ID Card Copy function to copy the front and back sides of a driver's license or other ID card on the same sheet of paper at 100% magnification. This can be quickly performed from the operation panel [Home] screen or using . This is useful such as when copying ID cards at reception.

- ▶ Placing the ID card on the platen glass(P. 260)
- ▶ Copying ID Cards (Touch Panel Model)(P. 261)
- ▶ Copying ID Cards (5 Lines LCD Model)(P. 262)

### Placing the ID card on the platen glass

- 1** Open the feeder or platen glass cover.

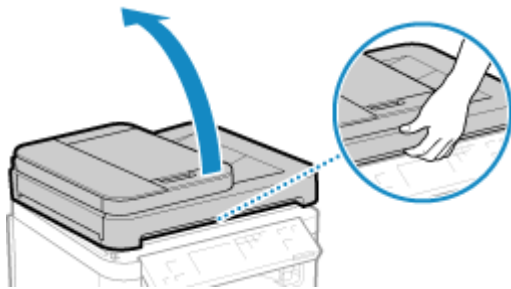

- 2** Place the front of the ID card face down on the platen glass in the portrait orientation while aligning the corner of the ID card with the top left corner of the platen glass.

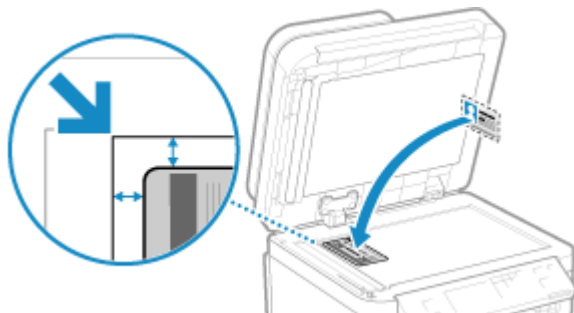

Place the ID card slightly away from the edge of the platen glass.

- 3** Gently close the feeder or platen glass cover.

## Copying ID Cards (Touch Panel Model)

- 1 On the operation panel, press [ID Card Copy] in the [Home] screen.  [Home] Screen(P. 113)

⇒ The copy screen is displayed.

- 2 Set the number of copies.

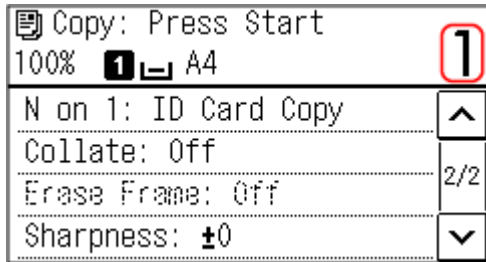

Use the numeric keys to enter the number of copies.

- 3 Adjust the density and image quality, as needed.

 Adjusting the Density(P. 247)

 Adjusting the Image Quality(P. 247)

\* When you make copies using the ID Card Copy function, the copy ratio is fixed at 100%.

- 4 Press .

⇒ The front of the ID card is scanned.

- 5 When [Scan Next: Press Start] is displayed, turn over the ID card and place it on the platen glass.

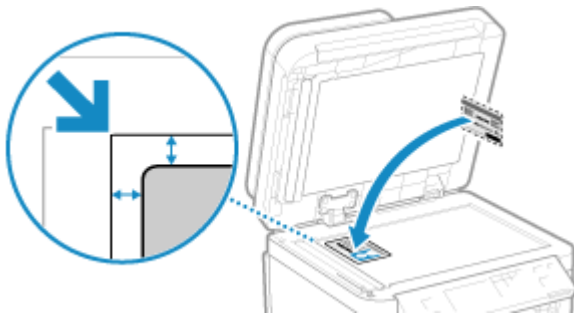

Place the back of the ID card face down in the same way as the front.

- 6 Press .

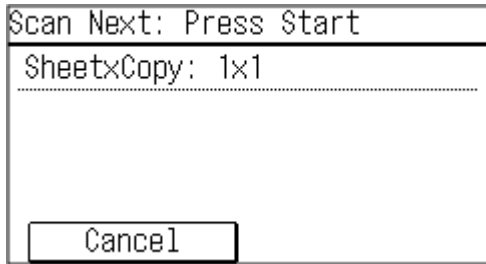

⇒ The back of the ID card is scanned and copying starts.

- To cancel copying, press [Cancel] ► [Yes]. ▶ **Canceling Copy Operations(P. 268)**
- Use [Status Monitor] to view the copy job status. ▶ **Viewing the Print Job Status and Log(P. 190)**

## Copying ID Cards (5 Lines LCD Model)

### 1 On the operation panel, press . ▶ **Operation Panel(P. 14)**

⇒ The copy screen is displayed.

### 2 Set the number of copies.

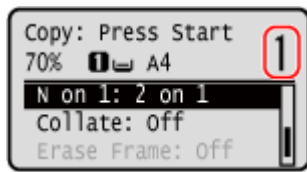

Press ▲ / ▼ ► [Number of Copies] ► , set the number of copies, and then press .

### 3 Adjust the density and image quality, as needed.

- ▶ **Adjusting the Density(P. 247)**
- ▶ **Adjusting the Image Quality(P. 247)**

\* When you make copies using the ID Card Copy function, the copy ratio is fixed at 100%.

### 4 Press .

⇒ The front of the ID card is scanned.

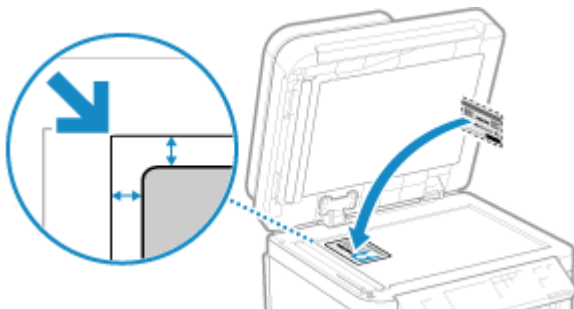

### 5 When [Scan Next: Press Start] is displayed, turn over the ID card and place it on the platen glass.

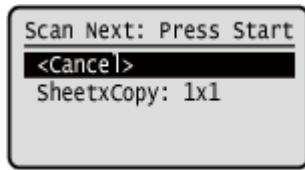

Place the back of the ID card face down in the same way as the front.

## 6 Press .



- ▢ The back of the ID card is scanned and copying starts.
- To cancel copying, press [<Cancel>] ►  ► [Yes] ► . ► **Canceling Copy Operations(P. 268)**
- Use [Status Monitor] to view the copy job status. ► **Viewing the Print Job Status and Log(P. 190)**



## Copying Multiple Passports onto One Sheet

94WS-06Y



You can use the Passport Copy function to copy multiple passports together onto one sheet of paper. This can be quickly performed from the [Home] screen on the operation panel.

- ▶ Placing a passport on the platen glass(P. 264)
- ▶ Copying Passport (Touch Panel Model)(P. 264)
- ▶ Copying Passport (5 Lines LCD Model)(P. 266)

### Placing a passport on the platen glass

- 1** Open the feeder or platen glass cover.

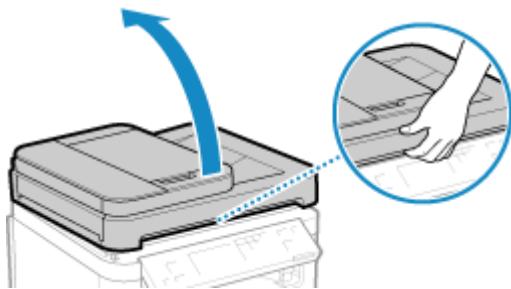

- 2** Place the page to be scanned face down while aligning the corner of the passport with the top left corner of the platen glass, as shown.

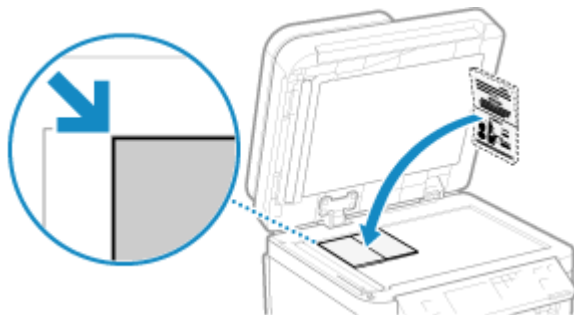

Place the ID card slightly away from the edge of the platen glass.

- 3** Gently close the feeder or platen glass cover.

### Copying Passport (Touch Panel Model)

- 1** On the operation panel, press [Passprt Cpy] in the [Home] screen. ▶[Home] Screen(P. 113)

⇒ The [Passport Copy] screen is displayed.

## 2 Select a combination of the number of passports and whether to use 2-sided printing.

### [2 on 1 (2-Sided)]

Combines two passports onto one side of a sheet of paper by copying with 2-sided printing. Copies four passports onto both sides of a sheet of paper with 2-sided printing.

### [4 on 1 (2-Sided)]

Combines four passports onto one side of a sheet of paper by copying with 2-sided printing. Copies eight passports onto both sides of a sheet of paper with 2-sided printing.

### [2 on 1]

Combines two passports onto one side of a sheet of paper.

### [4 on 1]

Combines four passports onto one side of a sheet of paper.

⇒ The copy screen is displayed.

## 3 Set the number of copies.

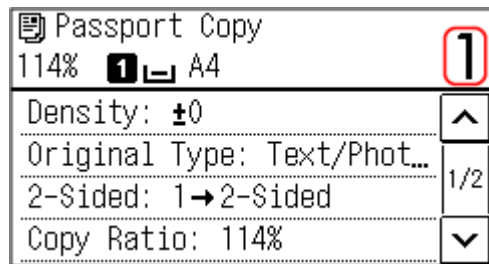

Use the numeric keys to enter the number of copies.

\* When you use Passport Copy to make copies, the copy ratio is set automatically according to the size of the paper used for copying and the number of passports to combine. You can also press [Copy Ratio] to change the copy ratio manually.

## 4 Configure the other copy settings, as needed. ▶ Additional Copying Features (Touch Panel Model)(P. 244)

- You can adjust the density and image quality.
- You can change the number of passports to combine (N on 1) and the 2-sided copy settings selected in 3.

## 5 Press [Start].

⇒ The first passport is scanned.

## 6 When [Scan Next: Press Start] is displayed, place the next passport on the platen glass, and press [Start].

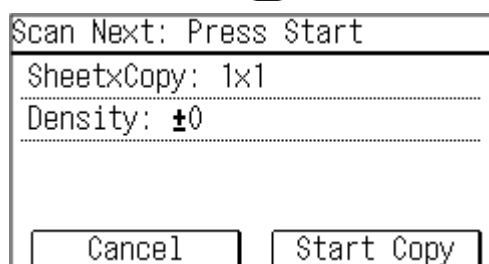

- ⇒ The next passport is scanned, and the same screen is displayed.  
Repeat this process until scanning of all passports is completed.
- You can also press [Density] to change the settings for each passport.

## 7 Press [Start Copy].

- ⇒ The scanned passports are printed.
- To cancel copying, press [Cancel] ► [Yes]. [▶Canceling Copy Operations\(P. 268\)](#)
- Use [Status Monitor] to view the copy job status. [▶Viewing the Print Job Status and Log\(P. 190\)](#)

## Copying Passport (5 Lines LCD Model)

### 1 On the operation panel, press [Passprt Cpy] in the [Home] screen, and press **OK**. [▶ \[Home\] Screen\(P. 113\)](#)

⇒ The [Passport Copy] screen is displayed.

### 2 Select a combination of the number of passports and whether to use 2-sided printing.

#### [2 on 1 (2-Sided)]

Combines two passports onto one side of a sheet of paper by copying with 2-sided printing. Copies four passports onto both sides of a sheet of paper with 2-sided printing.

#### [4 on 1 (2-Sided)]

Combines four passports onto one side of a sheet of paper by copying with 2-sided printing. Copies eight passports onto both sides of a sheet of paper with 2-sided printing.

#### [2 on 1]

Combines two passports onto one side of a sheet of paper.

#### [4 on 1]

Combines four passports onto one side of a sheet of paper.

### 3 Press **OK**.

⇒ The copy screen is displayed.

### 4 Set the number of copies.

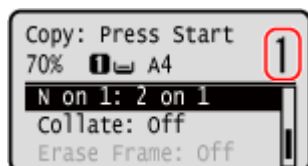

Press ▲ / ▼ ► [Number of Copies] ► **OK**, set the number of copies, and then press **OK**.

\* When you use Passport Copy to make copies, the copy ratio is set automatically according to the size of the paper used for copying and the number of passports to combine. You can also press [Copy Ratio] to change the copy ratio manually.

## 5 Configure the other copy settings, as needed. ▶ **Additional Copying Features (5 Lines LCD Model)(P. 250)**

- You can adjust the density and image quality.
- You can change the number of passports to combine (N on 1) and the 2-sided copy settings selected in 3.

## 6 Press .

⇒ The first passport is scanned.

## 7 When [Scan Next: Press Start] is displayed, place the next passport on the platen glass, and press .

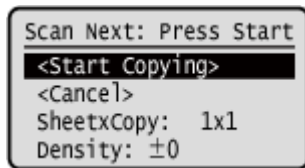



⇒ The next passport is scanned, and the same screen is displayed.  
Repeat this process until scanning of all passports is completed.

- You can also press [Density] to change the settings for each passport.

## 8 Press [**<Start Copying>**] ▶ .

⇒ The scanned passports are printed.

- To cancel copying, press [Cancel] ▶  ▶ [Yes] ▶ . ▶ **Canceling Copy Operations(P. 268)**
- Use [Status Monitor] to view the copy job status. ▶ **Viewing the Print Job Status and Log(P. 190)**

# Canceling Copy Operations

Follow the instructions on screen to cancel a copy operation.

- ▶ Touch Panel Model(P. 268)
- ▶ 5 Lines LCD Model(P. 268)

## Touch Panel Model

Press [Cancel] ▶ [Yes].

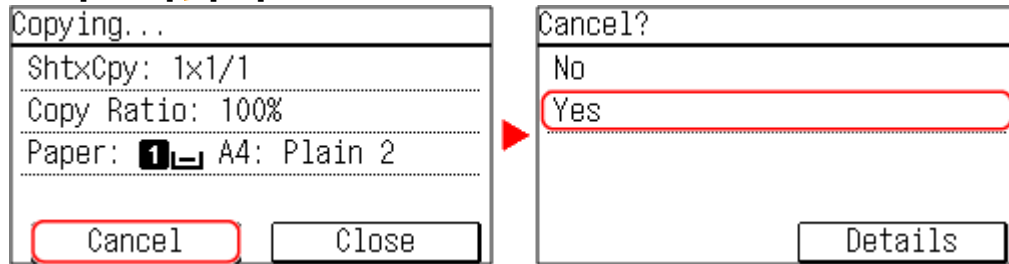

If the above screen is not displayed, on the operation panel, press ▶ [Yes].

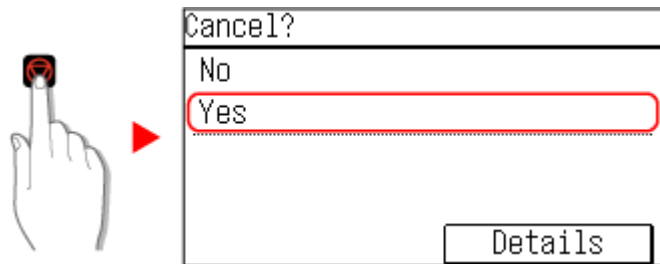

If the job list screen is displayed, select the job to cancel, and press [Yes].

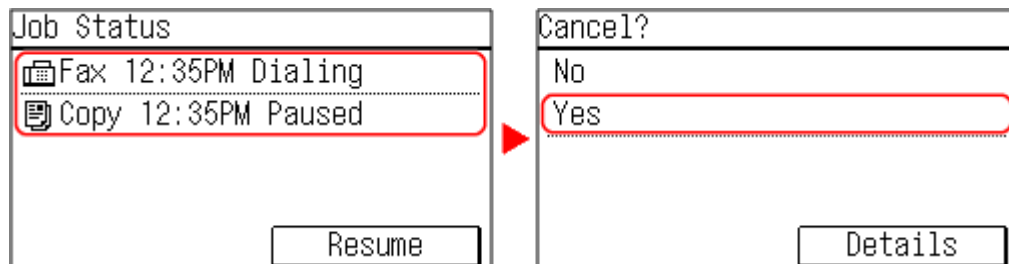

## 5 Lines LCD Model

Press [Cancel] ▶ ▶ [Yes] ▶ .

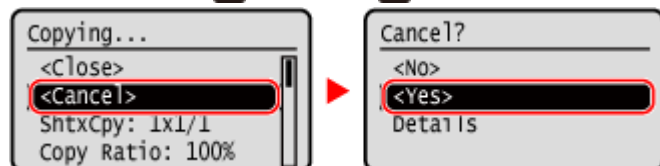

If the above screen is not displayed, on the operation panel, press ▶ [Yes] ▶ .

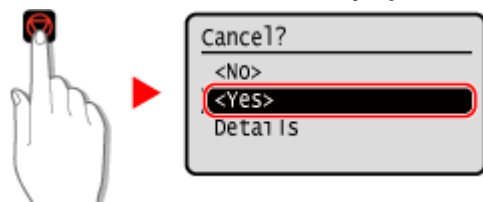

## Copying

If the job list screen is displayed, select the job to cancel, and press **OK** ► [Yes] ► **OK**.

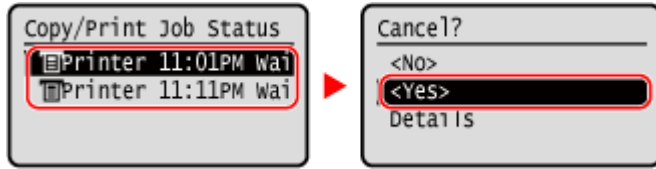

## Checking the Copy Status

94WS-071

Processes handled by the machine, including copying, are managed as jobs. By checking the status of jobs, you can determine whether a copy job was performed correctly.

Use the operation panel to configure the settings. You cannot configure the settings using Remote UI from a computer.

▶ **Touch Panel Model(P. 270)**

▶ **5 Lines LCD Model(P. 270)**

### Touch Panel Model

#### 1 Display the [Status Monitor] screen.

Press  on the operation panel . ▶ **Operation Panel(P. 14)**

#### 2 Press [Copy/Print Job].

⇒ The [Copy/Print Job] screen is displayed.

#### 3 Press [Job Status].

#### 4 Select a job to view its details.

⇒ The job details are displayed.

#### 5 Check the number of originals, number of copies, and other settings.

### 5 Lines LCD Model

#### 1 Display the [Status Monitor] screen.

On the operation panel, press [Status Monitor] ▶  in the [Home] screen or other screen.

▶ **[Home] Screen(P. 113)**

#### 2 Press [Copy/Print Job], and press .

⇒ The [Copy/Print Job] screen is displayed.

#### 3 Press [Job Status] ▶ .

**4** Select a job to view its details, and press **OK**.

⇒ The job details are displayed.

**5** Check the number of originals, number of copies, and other settings.



# Linking with Mobile Devices and Integrating with a Cloud Service

<b>Linking with Mobile Devices and Integrating with a Cloud Service</b> .....	273
<b>Preparations for Linking with Mobile Devices and Integrating with a Cloud Service</b> .....	274
Preparations for Direct Connection .....	275
Preparations for Using Universal Print .....	278
Registering the Machine to Azure Active Directory .....	279
Registering the Machine to the Computer .....	282
Preparations for Using AirPrint .....	283
<b>Connecting a Mobile Device to the Machine</b> .....	286
Connecting a Mobile Device via Wireless LAN Router (LAN Connection) .....	287
Connecting a Mobile Device Directly to the Machine (Direct Connection) .....	288
<b>Using a Dedicated Application to Print and Scan (Canon PRINT Business)</b> .....	291
<b>Printing with Universal Print</b> .....	292
<b>Using AirPrint Application to Print and Scan Data and Send Faxes</b> .....	293
<b>Printing from an Android Device</b> .....	297
<b>Printing from Chromebook or Other Device with Chrome OS</b> .....	298

# Linking with Mobile Devices and Integrating with a Cloud Service

---

94WS-072

The machine can be operated from a smartphone, tablet, or other mobile device, or from a cloud service. You can use a compatible application or service to easily print or scan photos and documents.

## Canon PRINT Business

---

Dedicated Canon application. Enables printing and scanning.

🔗 **Using a Dedicated Application to Print and Scan (Canon PRINT Business)(P. 291)**

## Universal Print

---

Enables you to print documents from Windows devices via the Microsoft Cloud. If your device is connected to the Internet, you can print documents when you are away from the machine.

🔗 **Preparations for Using Universal Print(P. 278)**

🔗 **Printing with Universal Print(P. 292)**

## AirPrint

---

This is a standard function on an iPhone, iPad, iPod touch, and Mac. You can print from applications that support AirPrint without having to install a dedicated application or driver. You can also scan data and send faxes with a Mac.

🔗 **Preparations for Using AirPrint(P. 283)**

🔗 **Using AirPrint Application to Print and Scan Data and Send Faxes(P. 293)**

## Canon Print Service

---

Dedicated Canon plugin for Android devices. Enables printing from any application.

🔗 **Using a Dedicated Plugin to Print (Canon Print Service)(P. 297)**

## Mopria® Print Service

---

Common plugin for Mopria® certified printers and multifunction machines. Enables printing from any application on an Android device without having to install a dedicated plugin or application for individual manufacturers.

🔗 **Using a Common Plugin to Print (Mopria® Print Service)(P. 297)**

## Chrome OS

---

You can use the function standard equipped in the Chrome operating system to print without having to install a dedicated application or printer driver.

🔗 **Printing from Chromebook or Other Device with Chrome OS(P. 298)**

## ■ See Also

### Managing the Machine from a Mobile Device (Remote UI)

You can use Remote UI from a Web browser on a mobile device. With Remote UI, you can check the operation status of the machine, change the machine settings, and register destinations to the Address Book. For details about starting and operating Remote UI, see the instructions for using Remote UI on a computer.

🔗 **Managing the Machine from a Computer (Remote UI)(P. 348)**

\* Some display items are omitted in the mobile version of Remote UI. To check all items, tap [PC Version] at the bottom of the screen and switch to the computer version of Remote UI.

# Preparations for Linking with Mobile Devices and Integrating with a Cloud Service

---

94WS-073

To directly connect a mobile device to the machine or to use Universal Print or AirPrint, you must first configure the settings on the machine.

- ▶ **Preparations for Direct Connection(P. 275)**
- ▶ **Preparations for Using Universal Print(P. 278)**
- ▶ **Preparations for Using AirPrint(P. 283)**

# Preparations for Direct Connection

94WS-074

Enable the Direct Connection function on the machine. If the machine is not connected to a network, you need to check the Network Connection Type settings.

- ▶ **Enabling the Direct Connection Function(P. 275)**
- ▶ **Checking the Network Connection Type of the Machine(P. 276)**

## Enabling the Direct Connection Function

This section describes how to configure the settings using Remote UI from a computer.

On the operation panel, select [Menu] in the [Home] screen, and then select [Preferences] to configure the settings. ▶ **[Direct Connection Settings](P. 386)**

Administrator privileges are required. The machine must be restarted to apply the settings.

- 1 Log in to Remote UI in System Manager Mode. ▶ Starting Remote UI(P. 349)**
  - 2 On the Portal page of Remote UI, click [Settings/Registration]. ▶ Portal Page of Remote UI(P. 351)**
  - 3 Click [Network Settings] ▶ [Direct Connection Settings] ▶ [Edit].**
- ⇒ The [Edit Direct Connection Settings] screen is displayed.
- 4 Select the [Use Direct Connection] checkbox.**
  - 5 Configure the Direct Connection function, as needed.**

When connecting multiple mobile devices at the same time, you must specify the SSID and network key.

### ■ To Terminate the Connection Automatically

Select the [Terminate Direct Connection Session] checkbox, and enter the time period of the direct connection until it is terminated. When multiple mobile devices are connected, they will be disconnected after the time period elapses since the last started connection.

### ■ To Change the IP Address for Connection

In [IP Address for Direct Connection], enter any IP address.

### ■ To specify the SSID and Network Key (When Connecting Multiple Mobile Devices at the Same Time)

By default, the SSID and network key of the machine are automatically assigned a random character string each time direct connection is performed.

To specify the SSID and network key manually, in [Access Point Mode Settings], select the [Specify SSID to Use] or [Specify Network Key to Use] checkbox, and enter an SSID or network key using single-byte alphanumeric characters.

### ■ To Allow Mobile Devices to Always Connect to the Machine

By default, you must use the operation panel to put the machine into waiting state when you want to establish a direct connection.

To allow mobile devices to always connect to the machine, in [Access Point Mode Settings], specify the SSID and network key, and select the [Always Keep Enabled If SSID/Network Key Is Specified] checkbox in [Keep Connection Enabled].

## 6 Click [OK].

## 7 Restart the machine. ▶ **Restarting the Machine(P. 106)**

⇒ The settings are applied.

## Checking the Network Connection Type of the Machine

If the machine is not connected to a network (wired or wireless LAN), check that the network connection type is set to wired LAN.

If the machine is connected to a network, you do not have to check this.

▶ **Touch Panel Model(P. 276)**

▶ **5 Lines LCD Model(P. 276)**

### ■ Touch Panel Model

#### 1 Press on the operation panel. ▶ **Operation Panel(P. 14)**

⇒ The [Status Monitor] screen is displayed.

#### 2 Press [Network Information] ▶ [Network Connection Method].

⇒ The [Network Conn. Method] screen is displayed.

#### 3 Check that [Wired LAN] is displayed.

If the connection type is set to wired LAN, you can establish a direct connection even if the machine is not connected to a network.

#### ■ **When [Wireless LAN] Is Displayed in [Network Conn. Method]**

When the machine is not connected to a wireless LAN, a direct connection cannot be established. Connect the machine to a wireless LAN or switch the connection type to wired LAN.

▶ **Connecting to a Wireless LAN(P. 54)**

▶ **Selecting Wired or Wireless LAN(P. 51)**

### ■ 5 Lines LCD Model

#### 1 On the operation panel, press [Status Monitor] in the [Home] screen ▶ . ▶ **[Home] Screen(P. 113)**

⇒ The [Status Monitor] screen is displayed.

**2** Press [Network Information] ► **OK** ► [Network Connection Method] ► **OK**.

⇒ The [Network Conn. Method] screen is displayed.

**3** Check that [Wired LAN] is displayed.

If the connection type is set to wired LAN, you can establish a direct connection even if the machine is not connected to a network.

■ **When [Wireless LAN] Is Displayed in [Network Conn. Method]**

When the machine is not connected to a wireless LAN, a direct connection cannot be established. Connect the machine to a wireless LAN or switch the connection type to wired LAN.

- ▶ **Connecting to a Wireless LAN(P. 54)**
- ▶ **Selecting Wired or Wireless LAN(P. 51)**

## Preparations for Using Universal Print

---

94WS-04C

Configure the machine to be able to use Microsoft's cloud service, Universal Print, and register the machine to each computer that will be used to print.

You must be a registered user of Microsoft 365 and use Azure Active Directory.

▶ **Registering the Machine to Azure Active Directory(P. 279)**

▶ **Registering the Machine to the Computer(P. 282)**

# Registering the Machine to Azure Active Directory

94WS-04E

Register the machine to the cloud-based authentication and management service, Azure Active Directory, and set the members or groups that will use the machine.

🔗 **Step 1: Registering the Machine to Azure Active Directory(P. 279)**

🔗 **Step 2: Specifying the Members and Groups to Use the Machine(P. 281)**

## Step 1: Registering the Machine to Azure Active Directory

Configure this setting using Remote UI from a computer. You cannot use the operation panel to configure the settings.

Administrator privileges are required.

**1 Log in to Remote UI in System Manager Mode. 🔗 Starting Remote UI(P. 349)**

**2 On the Portal page of Remote UI, click [Settings/Registration]. 🔗 Portal Page of Remote UI(P. 351)**

**3 Click [Network Settings] ▶ [Universal Print Settings].**

⇒ The [Universal Print Settings] screen is displayed.

**4 Click [Edit] in [Basic Settings].**

**5 Select the [Use Universal Print] checkbox, and enter the printer name.**

- For the printer name, enter a name to identify the machine, using single-byte alphanumeric characters.
- To verify the certificate sent from the server, select the [Verify Server Certificate] checkbox. To add a Common Name (CN) to the verification items, select the [Add CN to Verification Items] checkbox as well.

**6 Change Application ID and the URL of Azure Active Directory according to usage environment.**

**7 Click [OK].**

⇒ The [Universal Print Settings] screen is displayed.

**8 Click [Register] in [Registration Status].**

⇒ The [Information for Registration] screen is displayed.



## 9 Wait several seconds, and then click [↻].

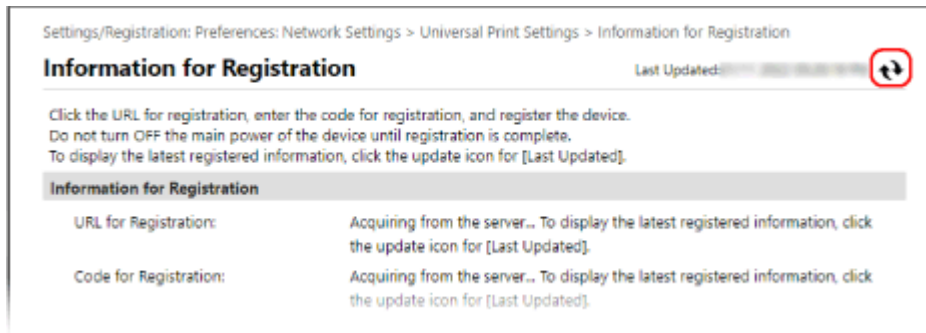

## 10 Click the link displayed in [URL for Registration].

## 11 Register the machine according to the instructions on the screen.

## 12 Click [Universal Print Settings] at the top of the Remote UI screen.

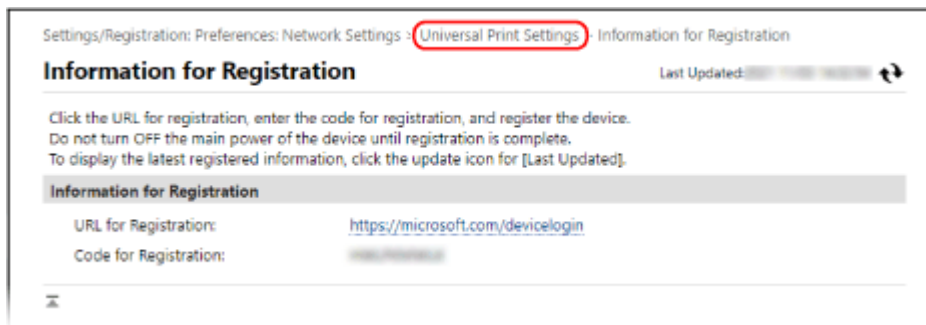

⇒ The [Universal Print Settings] screen is displayed.

## 13 Wait a few minutes, and then click [↻].

⇒ When registration is complete, [Registered] is displayed in [Registration Status].

## 14 Log out from Remote UI.

### NOTE

#### Canceling the Registration

- Click [Unregister] on the [Universal Print Settings] screen ► [OK]. On the Azure Active Directory device management screen, select the machine and click [Delete].

## Step 2: Specifying the Members and Groups to Use the Machine

- 1 Display the Universal Print management screen of Azure Active Directory in a Web browser on a computer.**
- 2 Select the machine, and click [Share Printer].**  
To change the name of the machine displayed on the computer, change [Printer Share Name].
- 3 Click [Members] ► [Add].**
- 4 From the list, select the members and groups who will use the printer.**

# Registering the Machine to the Computer

94WS-04F

Register the machine, which is registered to Azure Active Directory, to the computer to be used for Universal Print.

## Required Preparations

- Register the machine to Azure Active Directory. [▶ Registering the Machine to Azure Active Directory\(P. 279\)](#)

**1** Click [] (Start) ▶ [] (Settings) ▶ [Accounts].

⇒ The [Your info] screen is displayed.

**2** Click [Access work or school] ▶ [Connect].

**3** Follow the on-screen instructions to sign in to your Microsoft 365 account.

**4** Click [Home] ▶ [Devices] ▶ [Printers & scanners].

⇒ The [Printers & scanners] screen is displayed.

**5** Click [Add a printer or scanner].

⇒ The printer list screen is displayed.

**6** Select the machine and click [Add device].

⇒ The machine is registered to the computer.

## NOTE

### When Using a Proxy Server

- To use Universal Print via a proxy server, you must configure the proxy settings on each computer. For details, contact the network administrator.

# Preparations for Using AirPrint

94WS-075

Set the basic information that is required to use AirPrint. Configure the settings related to the functions and security that will be used, according to your usage and environment.

- ◉ **Setting the Basic Information of AirPrint(P. 283)**
- ◉ **Setting the Functions and Security to Be Used with AirPrint(P. 284)**

## Setting the Basic Information of AirPrint

Configure these settings using Remote UI from a computer. You cannot use the operation panel to configure the settings.

Administrator privileges are required.

- 1 Log in to Remote UI in System Manager Mode. ◉Starting Remote UI(P. 349)**
- 2 On the Portal page of Remote UI, click [Settings/Registration]. ◉Portal Page of Remote UI(P. 351)**
- 3 Click [Network Settings] ▶ [AirPrint Settings] ▶ [Edit].**

⇒ The [Edit AirPrint Settings] screen is displayed.

### **4 Select the [Use AirPrint] checkbox, and enter the printer name.**

- For the printer name, enter a name to identify the machine, using single-byte alphanumeric characters.
- If mDNS of IPv4 is set, the mDNS name is entered for the printer name. If you change the printer name, the mDNS name is also changed.

\* When you change the set printer name or mDNS name, the Mac that was connected to the machine may no longer be able to connect to it. In this case, you must register the machine on the Mac.

### **5 Enter the location and longitude and latitude of the machine, as needed.**

If the location of the machine is set in [Settings/Registration] ▶ [Device Management] ▶ [Device Information Settings], the same character string is entered in the location. When you change the location in AirPrint Settings, the location in Device Information Settings is also changed.

### **6 Click [OK].**

⇒ The settings are applied.

### **7 Log out from Remote UI.**

## NOTE

- When the AirPrint function is enabled, the following network settings are also enabled:

- HTTP ▶[Use HTTP](P. 398)
- IPP printing ▶[IPP Print Settings](P. 398)
- mDNS (IPv4) ▶[mDNS Settings](P. 394)
- mDNS (IPv6) ▶[mDNS Settings](P. 394)
- Network Link Scan ▶[Network Link Scan Settings](P. 398)

## Setting the Functions and Security to Be Used with AirPrint

AirPrint uses the following protocols:

- IPP (printing and sending faxes)
- Network Link Scan (scanning)

The protocol to use varies with the function. Therefore, you can restrict the available functions by disabling the protocols. In addition, you can configure the settings to encrypt communication with TLS and configure IPP authentication when using a protocol.

Configure these settings using Remote UI from a computer. You cannot use the operation panel to configure the settings.

Administrator privileges are required.

### Required Preparations

- When encrypting communication with TLS, specify the key and certificate to use for TLS encrypted communication. ▶Using TLS(P. 310)

**1 Log in to Remote UI in System Manager Mode.** ▶Starting Remote UI(P. 349)

**2 On the Portal page of Remote UI, click [Settings/Registration].** ▶Portal Page of Remote UI(P. 351)

**3 Click [Network Settings] ▶ [IPP Print Settings] or [Network Link Scan Settings] ▶ [Edit].**

⇒ The [Edit IPP Print Settings] screen or [Edit Network Link Scan Settings] screen is displayed.

**4 Configure the IPP or Network Link Scan settings.**

#### ■When Restricting the Functions to Use

Clear the [Use IPP Printing] or [Use Network Link Scan] checkboxes.

- When you clear the [Use IPP Printing] checkbox, printing and sending faxes with AirPrint are no longer possible.
- When you clear the [Use Network Link Scan] checkbox, scanning is no longer possible with AirPrint.

#### ■When Encrypting Communication with TLS

Select the [Allow Only When Using TLS] or [Use TLS] checkbox.

#### ■When Setting IPP Authentication

Select the [Use Authentication] checkbox, and set the user name to be used for IPP authentication using single-byte alphanumeric characters.

To set a password, select the [Set/Change Password] checkbox, and enter the same password in both [Password] and [Confirm] using single-byte alphanumeric characters. Printing or sending faxes with AirPrint now requires authentication, and only users who know the user name and password of IPP authentication can use these functions.

## **5 Click [OK].**

▣→ The settings are applied.

## **6 Log out from Remote UI.**

## Connecting a Mobile Device to the Machine

---

94WS-076

To use the machine from a mobile device, you must connect it to the machine using either of the following methods:

### Connecting via Wireless LAN Router (LAN Connection)

Connect a mobile device to the machine via a wireless LAN router in the same way as you connect a computer to the machine. By configuring a mobile device to connect automatically to the wireless LAN router, you do not need to manually connect it next time.

#### ▶ Connecting a Mobile Device via Wireless LAN Router (LAN Connection)(P. 287)



### Connecting Directly (Direct Connection)

Connect a mobile device directly to the machine via Wi-Fi. You can directly connect to the machine without using wireless LAN router. You must manually connect the mobile device each time you use the machine.

#### ▶ Preparations for Direct Connection(P. 275)

#### ▶ Connecting a Mobile Device Directly to the Machine (Direct Connection)(P. 288)



## Connecting a Mobile Device via Wireless LAN Router (LAN Connection)

94WS-077

Connect a mobile device to the machine via a wireless LAN router in the same way as you connect a computer to the machine. By configuring a mobile device to connect automatically to the wireless LAN router, you do not need to manually connect it next time.



### Required Preparations

- Connect the machine to the network using wireless or wired LAN. ▶ **Setting Up the Network(P. 49)**
  - \* When using a wired LAN, check that a wireless LAN router is connected to the same network.
- Set an IPv4 address to the machine. ▶ **Setting IPv4 Addresses(P. 70)**

Connect the mobile device to either of the following wireless LAN routers:

- A wireless LAN router connected to the machine
- (When the machine is connected to a wired LAN) A wireless LAN router on the network connected to the machine

For details about how to connect a mobile device to a wireless LAN router, see the manual of the mobile device.



# Connecting a Mobile Device Directly to the Machine (Direct Connection)

94WS-078

Connect a mobile device directly to the machine via Wi-Fi. You can directly connect it to the machine without using wireless LAN router. You must manually connect the mobile device each time you use the machine.

To connect a mobile device directly, use the operation panel to put the machine into the waiting state, and then search for the machine from the mobile device. Next, enter the network key to connect the mobile device to the machine.

By default, only one mobile device can be directly connected to the machine at any one time. Setting a fixed SSID and network key enables you to connect up to five mobile devices at the same time.



## Required Preparations

- Make preparations such as enabling the Direct Connection function on the machine. [▶Preparations for Direct Connection\(P. 275\)](#)

[▶Touch Panel Model\(P. 288\)](#)

[▶5 Lines LCD Model\(P. 289\)](#)

## Touch Panel Model

### 1 On the operation panel, press [Mobile Portal] in the [Home] screen. [▶\[Home\] Screen\(P. 113\)](#)

⇒ The [Mobile Portal] screen is displayed.

### 2 Press [Start].

⇒ The machine enters waiting state for Direct Connection.

- Within 5 minutes of pressing [Start], you must directly connect the mobile device.
- You can skip this step when [Connect from device you want to connect.] is displayed. Proceed to Step 3.
- When [Maximum number of wireless devices connected using Direct Connection has been reached.] is displayed, you cannot connect a new mobile device until a connected mobile device is disconnected. To disconnect a connected mobile device, press [OK] ▶ [Disconnect].

\* By default, only one mobile device can be directly connected to the machine at any one time.

### 3 Directly connect the mobile device.

1 Check the machine's SSID and network key displayed on the operation panel screen.

2 In the Wi-Fi settings of the mobile device, select the SSID of the machine, and enter the network key.

⇒ The [Mobile Portal] screen reappears.

By default, only one mobile device can be directly connected to the machine at any one time.  
[Maximum number of wireless devices connected using Direct Connection has been reached.] is displayed on the screen.

For details about how to configure the Wi-Fi settings, see the manual of the mobile device.

## 4 When you have completed your operations on the mobile device, press [Disconnect].

⇒ The direct connection is terminated.

If multiple mobile devices are connected, all devices are disconnected.

## 5 Lines LCD Model

### 1 On the operation panel, select [Mobile Portal] in the [Home] screen, and press **OK**.

**[Home] Screen(P. 113)**

⇒ The [Mobile Portal] screen is displayed.

### 2 Select [<Connect>] and press **OK**.

⇒ The machine enters waiting state for Direct Connection.

- Within 5 minutes of pressing [<Connect>], you must directly connect the mobile device.
- You can skip this step when [Connect from device you want to connect.] is displayed. Press **OK** and proceed to Step 3.
- When [Maximum number of wireless devices connected w/ Direct Connection has been reached.] is displayed, you cannot connect a new mobile device until a connected mobile device is disconnected. To disconnect a connected mobile device, press **OK** ▶ [<Disconnect>] ▶ **OK**.

\* By default, only one mobile device can be directly connected to the machine at any one time.

### 3 Directly connect the mobile device.

1 Check the machine's SSID and network key displayed on the operation panel screen.

2 In the Wi-Fi settings of the mobile device, select the SSID of the machine, and enter the network key.

⇒ The [Mobile Portal] screen reappears.

By default, only one mobile device can be directly connected to the machine at any one time.

[Maximum number of wireless devices connected w/ Direct Connection has been reached.] is displayed on the screen.

For details about how to configure the Wi-Fi settings, see the manual of the mobile device.

### 4 When you have completed your operations on the mobile device, press [<Disconnect>] ▶ **OK**.

⇒ The direct connection is terminated.

If multiple mobile devices are connected, all devices are disconnected.



- You may not be able to connect to the Internet with Direct Connection depending on the mobile device.
- The power-saving effect of sleep mode decreases when using Direct Connection.
- The IP address of the mobile device is set automatically. If you set the IP address manually, communication using Direct Connection may not be performed correctly.

## NOTE

### Checking a Mobile Device Connected to the Machine

- When using Direct Connection, press [Connection Information] to display the information of the mobile device connected to the machine with Direct Connection.

### If the Direct Connection Is Automatically Disconnected

- The direct connection is automatically terminated in the following cases:
  - When the Direct Connection Termination is set
  - When no data is sent or received between the mobile device and the machine for a while
  - When you are using the machine via a wireless LAN connection and the connection drops out

## Using a Dedicated Application to Print and Scan (Canon PRINT Business)

---

94WS-079

You can use the dedicated Canon application Canon PRINT Business to print and scan.

### Compatible Operating Systems and Download Site

See the Canon website.

<https://global.canon/gomp/>

### Usage

- Connect a mobile device to the machine. ▶ **Connecting a Mobile Device to the Machine(P. 286)**
- Register the machine to Canon PRINT Business.  
When the mobile device is connected to the machine via LAN, the IP address information of the machine is required to register the machine to Canon PRINT Business. You can view the IP address with [Home] screen ▶ [Mobile Portal] ▶ [Display Device Name/IP Address]. For the 5 lines LCD model you can view the IP address with [Mobile Portal] on the control panel ▶ **OK** ▶ [Display Device Name/IP Address] ▶ **OK**.
- For details about registering the machine, printing, and scanning, see the Help menu item in the application.

## Printing with Universal Print

---

94WS-04U

Universal Print is a Microsoft service that enables you to print documents via the cloud. There is no need to install a printer driver to print documents from your computer. You can also print documents from a remote location as long as your computer is connected to the Internet.

To use Universal Print, you must be a registered user of Microsoft 365 and use Azure Active Directory.

### Required Preparations

- Register the machine to Azure Active Directory, and set the members or groups that will use the machine. [▶ Registering the Machine to Azure Active Directory\(P. 279\)](#)
- To each computer that will use Universal Print, register the machine that is registered to Azure Active Directory. [▶ Registering the Machine to the Computer\(P. 282\)](#)

For details about how to print with Universal Print and the supported operating systems, see the Microsoft website. <https://docs.microsoft.com/>

# Using AirPrint Application to Print and Scan Data and Send Faxes

94WS-07A

AirPrint is a print function standard in Apple operating systems. You can print from applications that support AirPrint instead of having to install a dedicated application or driver.

In addition, you can use AirPrint to print from a Mac. You can also scan data and send faxes with a Mac.

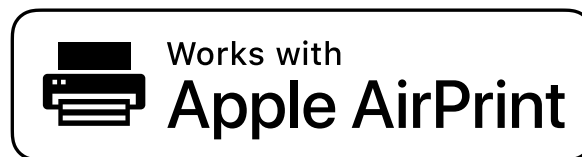

▶ **When Using an iPhone, iPad, or iPod touch(P. 293)**

▶ **When Using a Mac(P. 294)**

## When Using an iPhone, iPad, or iPod touch

Use AirPrint to print from an iPhone, iPad, or iPod touch connected to the machine via LAN or direct connection.

### Operating Environment

You can use AirPrint with the following iPhone, iPad, and iPod touch models:

- iPhone: 3GS or later
- iPad: All models
- iPod touch: Third generation or later

### Required Preparations

- Set the machine to enable use of AirPrint. ▶ **Preparations for Using AirPrint(P. 283)**
- Connect the machine to an iPhone, iPad, or iPod touch. ▶ **Connecting a Mobile Device to the Machine(P. 286)**

**1 Open the data to be printed on the iPhone, iPad, or iPod touch.**

**2 In the application with the data to be printed open, tap [🖨️].**

⇒ The menu options are displayed.

**3 Tap [Print].**

⇒ The print options are displayed.

If print options are not displayed, the application does not support AirPrint. In this case, you cannot use AirPrint to print data.

## 4 Tap [Printer], and select the machine.

## 5 Configure the print settings.

The available settings and usable paper sizes vary depending on the application you are using.

## 6 Tap [Print].

⇒ Printing starts.

Use  or [Status Monitor] on the operation panel to view the print job status and log. ▶ **Viewing the Print Job Status and Log(P. 190)**

## When Using a Mac

You can use AirPrint to print and scan data and send faxes from a Mac connected to the network on the same LAN as the machine or a Mac connected to the machine via USB.

### Operating Environment

You can use AirPrint on a Mac with the following operating systems installed:

- Printing: OS X 10.7 or later\*<sup>1</sup>
- Scanning: OS X 10.9 or later\*<sup>2</sup>
- Sending faxes: OS X 10.9 or later

\*<sup>1</sup> When printing from a Mac connected to the machine via USB, OS X 10.9 or later.

\*<sup>2</sup> When scanning with TLS encrypted communication, OS X 10.11 or later.

### Required Preparations

- Set the machine to enable use of AirPrint. ▶ **Preparations for Using AirPrint(P. 283)**
- Connect the machine to a Mac. ▶ **Setting Up the Network(P. 49)**  
When connecting via USB, connect to the USB port for computer connection on the back of the machine with a USB cable. ▶ **Rear Side(P. 12)**
- In [System Preferences] ▶ [Printers & Scanners] on the Mac, click [+] to register the machine.

▶ **Using AirPrint to Print Data(P. 294)**

▶ **Using AirPrint to Scan Data(P. 295)**

▶ **Using AirPrint to Send Faxes(P. 296)**

## ■ Using AirPrint to Print Data

### 1 Open the document you want to print on your Mac.

### 2 In the application used to open the document, click [Print].

⇒ The printing dialog box appears.

**3 In [Printer], select the machine.****4 Configure the print settings.**

The available settings and usable paper sizes vary depending on the application you are using.

**5 Click [Print].**

⇒ Printing starts.

Use  or [Status Monitor] on the operation panel to view the print job status and log. ▶ **Viewing the Print Job Status and Log(P. 190)**

**■ Using AirPrint to Scan Data****1 Place the original on the machine. ▶ Placing Originals(P. 129)****2 On your Mac, Click [System Preferences] ▶ [Printers & Scanners].**

⇒ The [Printers & Scanners] screen is displayed.

**3 Select the machine.****4 On the [Scan] tab, click [Open Scanner].**

⇒ The [Scanner] screen is displayed.

**5 Configure the scan settings.****6 Click [Scan].**

⇒ Scanning starts.

**NOTE****When Scanning Cannot Be Performed**

- The machine may not be online (scan standby mode). On the operation panel, select [Scan] in the [Home] screen, and press [Remote Scanner] to turn the machine online, and then repeat the operation.



## ■ Using AirPrint to Send Faxes

**1** Open the document you are sending on your Mac.

**2** From the menu in the application used to open the document, click [Print].

⇒ The printing dialog box appears.

**3** In [Printer], select the machine.

Select the printer whose name ends with "Fax."

**4** In [To], enter the fax number.

**5** Click [Fax].

⇒ The fax is sent via the machine.

Use [Status Monitor] on the operation panel to view the sending status and log. ▶ **Checking the Status and Log for Sent and Received Faxes(P. 236)**

## Printing from an Android Device

94WS-07C

Install a plugin on a mobile device to enable printing from an application that has a print function. This machine supports Canon plugins as well as Mopria®, which is supported by various manufacturers.

- ▶ **Using a Dedicated Plugin to Print (Canon Print Service)(P. 297)**
- ▶ **Using a Common Plugin to Print (Mopria® Print Service)(P. 297)**

### Using a Dedicated Plugin to Print (Canon Print Service)

You can use the dedicated Canon plugin Canon Print Service to print from any application.

#### Compatible Operating Systems and Download Site

See the Canon website.

<https://global.canon/psmp/>

#### Usage

- Connect a mobile device to the machine. ▶ **Connecting a Mobile Device to the Machine(P. 286)**
- Register the machine to Canon Print Service.  
When the mobile device is connected to the machine via LAN, the IP address information of the machine is required to register the machine to Canon Print Service. You can view the IP address with [Home] screen ▶ [Mobile Portal] ▶ [Display Device Name/IP Address]. For the 5 lines LCD model, you can view the IP address with [Mobile Portal] on the control panel ▶ **OK** ▶ [Display Device Name/IP Address] ▶ **OK**.
- For details about registering the machine and the printing method, see the Canon Print Service manual in "Mobile Apps" at the online manual site.  
<https://oip.manual.canon/>

### Using a Common Plugin to Print (Mopria® Print Service)

The machine supports Mopria® Print Service, a plugin that enables printing from any application on a Mopria® certified printer or multifunction machine.

You can print on a Mopria® certified printer available from various manufacturers, which is convenient when printing on the go, without having to install a dedicated application or plugin.



#### Usage

- Connect a mobile device to the machine. ▶ **Connecting a Mobile Device to the Machine(P. 286)**
- For details about how to print and Mopria® certified printers, see the following website:  
<https://mopria.org/>

## NOTE

- By using Mopria® Scan, you can directly import scanned data to an Android device. For information on how to scan, see the following website:  
<https://mopria.org/>

# Printing from Chromebook or Other Device with Chrome OS

94WS-07E

You can use a Chromebook or other device equipped with Chrome OS to print without having to install a dedicated application or printer driver.

## IMPORTANT

### Printing from a Chrome OS Device

- Printing from a Chrome OS device may not be supported depending on your country or region.

#### Usage

- Connect a Chromebook to the machine.
  - ▶ **Connecting a Mobile Device via Wireless LAN Router (LAN Connection)(P. 287)**  
When connecting via USB, connect to the USB port for computer connection on the back of the machine with a USB cable. ▶ **Rear Side(P. 12)**
- For details about how to print using the Chromebook, see Chromebook Help.  
<https://support.google.com/chromebook/answer/7225252/>

## NOTE

- You can also scan from a Chrome OS device without installing dedicated software.  
For information on how to scan, see the Chromebook Help page.  
<https://support.google.com/chromebook/answer/7225252/>

# Security

<b>Security</b> .....	300
<b>Setting the Department ID and PIN for the Administrator</b> .....	301
<b>Protecting the Network</b> .....	303
Setting the Firewall .....	304
Changing the Port Number .....	307
Using a Proxy .....	308
Using TLS .....	310
Using IEEE 802.1X .....	312
Managing and Verifying a Key and Certificate .....	314
Generating a Key and Certificate .....	315
Generating a Key and Certificate Signing Request (CSR) and Obtaining and Registering a Certificate ...	317
Registering a Key and Certificate or CA Certificate Obtained from an Issuing Authority .....	320
Verifying a Received Certificate with OCSP .....	322
<b>Preventing Sending Data by Mistake and Leaking Information</b> .....	323
Limiting Available Destinations .....	324
Confirming the Destination before Sending .....	326
Restricting Fax Sending .....	328
Restricting Printing (Touch Panel Model) .....	330
Saving Received Documents in the Machine (Memory Lock) (Touch Panel Model) .....	331
<b>Preventing Unauthorized Use</b> .....	334
Restricting Address Book Registration and Editing (Touch Panel Model) .....	335
Restricting Use of Remote UI .....	337
Restricting Use from a Mobile Device .....	340
Preventing Connection to Computer via USB Port .....	341
Configuring LPD, RAW, or WSD .....	342
Disabling HTTP Communication .....	344

# Security

---

94WS-07F

This machine is an information device that uses communication functions and handles various data. Therefore, it is important to provide measures to prevent unauthorized access when using the machine in a network environment and measures against security risks such as sending data by mistake and leaking information. This machine is equipped with various functions and settings to reduce these threats and vulnerabilities. Configure the settings and use them appropriately according to your usage environment and conditions for safer operation of the machine.

## Creating an Administrator System

Use an administrator account to manage the machine and configure the settings. Operate the machine using a system in which only a specific administrator(s) knows the ID and PIN.

### ▶ **Setting the Department ID and PIN for the Administrator(P. 301)**

## Network Settings

Applying the network security settings according to the usage environment can reduce the threat of unauthorized access and eavesdropping.

### ▶ **Protecting the Network(P. 303)**

## Managing Usage Status

When using the function to send a fax or scanned data, measures are needed to prevent sending data by mistake or leaking information. In addition, using a PIN and setting usage restrictions can help prevent unauthorized use of the Address Book and Remote UI. Implementing measures that include operations according to usage status of the machine can improve security.

### ▶ **Preventing Sending Data by Mistake and Leaking Information(P. 323)**

### ▶ **Preventing Unauthorized Use(P. 334)**

# Setting the Department ID and PIN for the Administrator

94WS-07H

Set the System Manager ID and System Manager PIN to create an administrator account. By creating an administrator account, only those users who know these credentials can log in to System Manager Mode to view and change important settings. **▶System Manager ID and PIN(P. 6)**

This section describes how to configure the settings using the operation panel. You can also configure the settings using Remote UI from a computer after the System Manager ID and PIN have been set on the machine. **▶Managing the Machine from a Computer (Remote UI)(P. 348)** Administrator privileges are required.

**▶Touch Panel Model(P. 301)**

**▶5 Lines LCD Model(P. 301)**

## ■ Touch Panel Model

**1 On the operation panel, press [Menu] in the [Home] screen. ▶[Home] Screen(P. 113)**

**2 Press [Management Settings] ▶ [User Management] ▶ [System Manager Information Settings].**

⇒ The [Sys. Manager Info Set.] screen is displayed.

If the login screen appears, enter the currently set System Manager ID and PIN, and then press [Log In].

**3 Press [System Manager ID and PIN], enter the System Manager ID, and press [Apply].**

Specify any number. You cannot set a System Manager ID consisting of all zeros, such as "00" or "0000000."

**4 Enter the System Manager PIN, and press [Apply].**

Specify any number other than "7654321." You cannot set a PIN consisting of all zeros, such as "00" or "0000000."

**5 Enter the PIN again, and press [Apply].**

⇒ The settings are applied.

## ■ 5 Lines LCD Model

**1 On the operation panel, select [Menu] in the [Home] screen, and press **OK**. ▶[Home] Screen(P. 113)**

**2 Press [Management Settings] ▶ **OK** ▶ [User Management] ▶ **OK** ▶ [System Manager Information Settings] ▶ **OK**.**

⇒ The [Sys. Manager Info Set.] screen is displayed.

If the login screen appears, enter the currently set System Manager ID and PIN, and then press [<Log In>] ► .

### 3 Press [System Manager ID and PIN] ► ► enter the System Manager ID ► .

Specify any number. You cannot set a System Manager ID consisting of all zeros, such as "00" or "0000000."

### 4 Enter the System Manager PIN, and press .

Specify any number other than "7654321." You cannot set a PIN consisting of all zeros, such as "00" or "0000000."

### 5 Enter the PIN again, and press .



⇒ The settings are applied.

## IMPORTANT

- Do not forget the System Manager ID and PIN. If you forget your System Manager ID and PIN, contact your dealer or service representative.  **If the Problem Persists(P. 581)**

## NOTE

### Setting the System Manager Information

- On the [Sys. Manager Info Set.] screen, press [System Manager Name] to set the name of the system manager.
- You can also configure the e-mail address and other system manager information by using Remote UI from a computer.
  - The set information is displayed in [Status Monitor/Cancel] ► [Device Information] of Remote UI.  **Checking Usage and Logs with Remote UI(P. 353)**
  - The set e-mail address becomes the destination that is selected by clicking [Mail to System Manager] on the Portal page of Remote UI.  **Portal Page of Remote UI(P. 351)**

### Clearing the System Manager ID and PIN Settings

- Clear the entered values of the System Manager ID and PIN, and then click [Apply] with the fields left empty.

# Protecting the Network

---

94WS-07X

Connecting the machine to a network allows you link it to computers and mobile devices for more convenient operations. However, this also creates risks of unauthorized access and eavesdropping over the network. By configuring the security settings according to your network environment, you can reduce these risks to ensure safer use of the machine.

## Filtering Using the Firewall Settings

Allows communications only with devices that have a specific IP address or MAC address to prevent unauthorized access.

### ▶ **Setting the Firewall(P. 304)**

## Port Control

If the port number being used by a communicating device, such as a computer or server, is changed, change the setting on the machine too. In addition, if it is clear that there is an unneeded protocol, use of the protocol is prohibited on the machine and that port is closed to prevent intrusion from the outside.

### ▶ **Changing the Port Number(P. 307)**

## Using a Proxy Server

Using a proxy server to connect the machine to a network not only facilitates managing communication with external networks but blocks unauthorized access and consolidates anti-virus protection for enhanced security.

### ▶ **Using a Proxy(P. 308)**

## Encryption of Communication Using TLS

You can use TLS to encrypt communication when using Remote UI. This reduces the risks of data eavesdropping and tampering during communication.

### ▶ **Using TLS(P. 310)**

## Using the Machine in a Network with IEEE 802.1X Authentication

When connecting the machine to a network that uses IEEE 802.1X authentication, you must configure the settings on the machine such as the authentication method managed by the authentication server.

### ▶ **Using IEEE 802.1X(P. 312)**

## Managing and Verifying the Key and Certificate

You can generate a key and certificate used to encrypt communication and register a key and certificate obtained from a certification authority. By configuring the settings to check the revocation status of a certificate (using OCSP), you can check to see if a certificate received from a certification authority has been revoked.

### ▶ **Managing and Verifying a Key and Certificate(P. 314)**

## ■ See Also

For the network settings at setup, see the following.

### ▶ **Configuring Your Machine for Your Network Environment(P. 76)**



# Setting the Firewall

94WS-07Y

Set up the packet-filtering firewall to prevent unauthorized access.

First, as a prerequisite, set whether to allow or block communication with other devices. Next, specify the IP addresses or MAC addresses of devices you want to block or allow as exceptions.

For the number of addresses that can be specified and the protocols whose communication can be restricted, see the firewall specifications. [▶Firewall\(P. 32\)](#)

[▶Setting IP Address Filtering\(P. 304\)](#)

[▶Setting MAC Address Filtering\(P. 305\)](#)

## IMPORTANT

- MAC address filtering is not available when connecting the machine to a wireless LAN.
- Multicast and broadcast addresses are not restricted even when the setting is configured to block the sending of data from the machine to other devices.

## Setting IP Address Filtering

Set IPv4 address filtering or IPv6 address filtering according to your usage environment.

This section describes how to configure the settings using Remote UI from a computer.

On the operation panel, select [Menu] in the [Home] screen, and then select [Preferences] to configure the settings.

However, the operation panel can only be used to enable or disable the filter. [▶\[Firewall Settings\]\(P. 389\)](#)

Administrator privileges are required. The machine must be restarted to apply the settings.

## IMPORTANT

- If you set an incorrect IP address, you will no longer be able to access Remote UI. If this happens, use the operation panel to disable the firewall settings, and then use Remote UI to set the IP address again.

**1** Log in to Remote UI in System Manager Mode. [▶Starting Remote UI\(P. 349\)](#)

**2** On the Portal page of Remote UI, click [Settings/Registration]. [▶Portal Page of Remote UI\(P. 351\)](#)

**3** Click [Network Settings] ▶ [Firewall Settings].

⇒ The [Firewall Settings] screen is displayed.

**4** Click [Edit] for the IP address send or receive filter.

- To restrict sending of data from the machine to other devices, click [Edit] for the send filter.
- To restrict receiving of data from other devices, click [Edit] for the receive filter.

## 5 Select the [Use Filter] checkbox.

⇒ The IP address is enabled.

## 6 In [Default Policy], set the filtering prerequisites.

As a filtering prerequisite, select whether to allow or block communication with other devices.

## 7 Register [Exception Addresses].

- In [Address to Register], enter an IP address, and then click [Add].
- You can also specify a range of IP addresses by using a hyphen (-) or prefix length.

### Input example:

- **One IPv4 address**  
192.168.0.10
- **One IPv6 address**  
fe80::10
- **Specifying a range**  
192.168.0.10-192.168.0.20  
192.168.0.32/27  
fe80::1234/64

## 8 Click [OK].

## 9 Restart the machine. ▶ [Restarting the Machine\(P. 106\)](#)

⇒ The settings are applied.

## Setting MAC Address Filtering

This section describes how to configure the settings using Remote UI from a computer. On the operation panel, select [Menu] in the [Home] screen, and then select [Preferences] to configure the settings. You cannot use the operation panel to configure some of the settings. ▶ [\[Firewall Settings\]\(P. 389\)](#) Administrator privileges are required. The machine must be restarted to apply the settings.

### **IMPORTANT**

- If you set an incorrect MAC address, you will no longer be able to access Remote UI. If this happens, use the operation panel to disable the firewall settings, and then use Remote UI to set the MAC address again.

## 1 Log in to Remote UI in System Manager Mode. ▶ [Starting Remote UI\(P. 349\)](#)

## 2 On the Portal page of Remote UI, click [Settings/Registration]. ▶ [Portal Page of Remote UI\(P. 351\)](#)

### 3 Click [Network Settings] ► [Firewall Settings].

⇒ The [Firewall Settings] screen is displayed.

### 4 Click [Edit] for the MAC address send or receive filter.

- To restrict sending of data from the machine to other devices, click [Edit] for the send filter.
- To restrict receiving of data from other devices, click [Edit] for the receive filter.

### 5 Select the [Use Filter] checkbox.

⇒ The MAC address is enabled.

### 6 In [Default Policy], set the filtering prerequisites.

As a filtering prerequisite, select whether to allow or block communication with other devices.

### 7 Register [Exception Addresses].

- In [Address to Register], enter a MAC address, and then click [Add].
- Enter MAC addresses without separating with hyphens (-) or colons (:).

**Input example:**

123A456B789C

### 8 Click [OK].

### 9 Restart the machine. ► [Restarting the Machine\(P. 106\)](#)

⇒ The settings are applied.

# Changing the Port Number

94WS-080

Typically, conventional port numbers are used for major protocols, but these port numbers may be changed to enhance security. As the port numbers must be the same on communicating devices, such as a computer or server, when the port number is changed, the setting on the machine also needs to be changed.

This section describes how to configure the settings using Remote UI from a computer.

On the operation panel, select [Menu] in the [Home] screen, and then select [Preferences] to configure the settings. **▶ [Port Number Settings](P. 398)**

Administrator privileges are required. The machine must be restarted to apply the settings.

- 1 Log in to Remote UI in System Manager Mode. ▶ Starting Remote UI(P. 349)**
- 2 On the Portal page of Remote UI, click [Settings/Registration]. ▶ Portal Page of Remote UI(P. 351)**
- 3 Click [Network Settings] ▶ [Port Number Settings] ▶ [Edit].**
  - ⇒ The [Edit Port Number Settings] screen is displayed.
- 4 Change the port number of the protocol, and click [OK].**
- 5 Restart the machine. ▶ Restarting the Machine(P. 106)**
  - ⇒ The settings are applied.

## NOTE

### Protocol Settings

- For the protocol settings and settings of the functions using the protocol, see the following:

**LPD/RAW/WSD ▶ Configuring LPD, RAW, or WSD(P. 342)**

**HTTP ▶ Disabling HTTP Communication(P. 344)**

**SNMP ▶ Configuring SNMP(P. 83)**

### Changing the Port Number of the Proxy Server or LDAP Server

- To change the port number of the proxy server, see the following:
  - ▶ **Using a Proxy(P. 308)**

### Changing the Port Number of the Printer Driver (Windows)

- When the port number of the print protocol (LPD or RAW) is changed on the machine, change the port number setting on the computer too. ▶ **Configuring a Printer Port (Windows)(P. 176)**

# Using a Proxy

94WS-081

Using a proxy server to connect to a network not only facilitates managing communications with external networks but blocks unauthorized access and consolidates anti-virus protection for enhanced security.

Configure these settings using Remote UI from a computer. You cannot use the operation panel to configure the settings.

Administrator privileges are required.

## Required Preparations

- Prepare the address, port number, and authentication information of the proxy server.

**1 Log in to Remote UI in System Manager Mode.**  **Starting Remote UI(P. 349)**

**2 On the Portal page of Remote UI, click [Settings/Registration].**  **Portal Page of Remote UI(P. 351)**

**3 Click [Network Settings] ▶ [Proxy Settings] ▶ [Edit].**

⇒ The [Edit Proxy Settings] screen is displayed.

**4 Select the [Use Proxy] checkbox.**

**5 Enter the address and port number of the proxy server.**

- In [HTTP Proxy Server Address], enter the IP address and host name.
- In [HTTP Proxy Server Port Number], enter the port number.

**6 Set the applicable range and authentication information according to your usage environment.**

**■When using a proxy server also specified for communication with devices on the same domain**

Select the [Use Proxy within Same Domain] checkbox.

**■When authentication is required to connect to a proxy server**

Select the [Use Proxy Authentication] checkbox, and enter the user name to be used for authentication using single-byte alphanumeric characters.

To set a password to use for authentication, select the [Set/Change Password] checkbox, and enter the password using single-byte alphanumeric characters.

**7 Click [OK].**

⇒ The settings are applied.

## **8 Log out from Remote UI.**

# Using TLS

94WS-082

Transport Layer Security (TLS) is a mechanism for encrypting data sent or received over the network. Encrypting communication with TLS when using Remote UI reduces the risks of data eavesdropping and tampering during communication.

To use TLS encrypted communication for Remote UI, specify the key and certificate (server certificate) you want to use, and then enable TLS on Remote UI.

This section describes how to configure the settings using Remote UI from a computer.

On the operation panel, select [Menu] in the [Home] screen, and then select [Management Settings] to configure the settings. However, the operation panel can only be used to enable or disable TLS on Remote UI.  **[Use Remote UI] (P. 456)**

Administrator privileges are required. The machine must be restarted to apply the settings.

## Required Preparations

- Prepare the key and certificate to use for TLS encrypted communication.  **Managing and Verifying a Key and Certificate(P. 314)**

### 1 Log in to Remote UI in System Manager Mode. Starting Remote UI(P. 349)

### 2 On the Portal page of Remote UI, click [Settings/Registration]. Portal Page of Remote UI(P. 351)

### 3 In [Network Settings], click [TLS Settings].

⇒ The [TLS Settings] screen is displayed.

### 4 Specify the key and certificate to use for TLS encrypted communication.

#### 1 In [Key and Certificate Settings], click [Key and Certificate].

⇒ The [Key and Certificate Settings] screen is displayed.

#### 2 To the right of the key and certificate to use, click [Register Default Key].

- When you click the key name (or certificate icon), the certificate details appear.
- On the certificate details screen, click [Verify Certificate] to verify that the certificate is valid.

### 5 Set the TLS version and algorithm.

#### 1 Click [TLS Details] ▶ [Edit].

⇒ The [Edit TLS Details] screen is displayed.

#### 2 Set the usable version and algorithm, and click [OK].

Some combinations of versions and algorithms cannot be used. For the supported combinations of versions and algorithms, see the TLS specifications.  **TLS(P. 33)**

#### [Allowed Versions]

Specify the maximum and minimum versions of TLS.

**[Algorithm Settings]**

Select the checkbox of the algorithm to use for TLS.

## 6 Enable TLS on Remote UI.

- 1 Click [License/Other] ► [Remote UI Settings] ► [Edit].  
    ⇒ The [Edit Remote UI Settings] screen is displayed.
- 2 Select the [Use TLS] checkbox, and click [OK].

## 7 Restart the machine. ► Restarting the Machine(P. 106)

⇒ The settings are applied.

### NOTE

#### When a Warning Message Appears at Remote UI Startup

- A warning message about the security certificate may appear when starting up Remote UI with TLS enabled. If there are no problems with the certificate or TLS settings, you can continue operations.



# Using IEEE 802.1X

94WS-084

In a network environment with IEEE 802.1X authentication, only client devices (supplicants) authenticated by the authentication server (RADIUS server) are allowed to connect to the network via the LAN switch (authenticator), thereby blocking unauthorized access. When connecting the machine to a network that uses IEEE 802.1X authentication, you must configure the settings on the machine such as the authentication method managed by the authentication server.

▶ **IEEE 802.1X Authentication Methods(P. 312)**

▶ **Setting IEEE 802.1X(P. 312)**

## IEEE 802.1X Authentication Methods

The following IEEE 802.1X authentication methods are supported:

### TLS

The machine and authentication server authenticate each other by mutually verifying their certificates. This cannot be used together with another authentication method.

### TTLS

This authentication method uses a user name and password for machine authentication and a CA certificate for the server authentication. MSCHAPv2 or PAP can be selected as the internal protocol, and TTLS can be used together with PEAP.

### PEAP

The required settings are almost the same as those for TTLS, with MSCHAPv2 used as the internal protocol.

## Setting IEEE 802.1X

First enable IEEE 802.1X, and then set the authentication method.

This section describes how to configure the settings using Remote UI from a computer.

On the operation panel, select [Menu] in the [Home] screen, and then select [Preferences] to configure the settings.

However, the operation panel can only be used to enable or disable IEEE 802.1X. ▶ **[IEEE 802.1X Settings](P. 389)**

Administrator privileges are required. The machine must be restarted to apply the settings.

### Required Preparations

- When using TLS as the authentication method, prepare the key and certificate issued by the certificate authority and used for authentication of the machine. ▶ **Managing and Verifying a Key and Certificate(P. 314)**
  - \* A preinstalled CA certificate or a CA certificate installed from Remote UI is used for server authentication.
- When using TTLS or PEAP as the authentication method, TLS-encrypt communication using Remote UI. ▶ **Using TLS(P. 310)**

**1** Log in to Remote UI in System Manager Mode. ▶ **Starting Remote UI(P. 349)**

**2** On the Portal page of Remote UI, click [Settings/Registration]. ▶ **Portal Page of Remote UI(P. 351)**

**3** Click [Network Settings] ▶ [IEEE 802.1X Settings] ▶ [Edit].

⇒ The [Edit IEEE 802.1X Settings] screen is displayed.

## 4 Select the [Use IEEE 802.1X] checkbox, and enter the login name.

For the login name, enter a name to identify the user (EAP Identity) using single-byte alphanumeric characters.

### ■ When verifying the certificate of an authentication server

Select the [Verify Authentication Server Certificate] checkbox.

When verifying the common name of the certificate, select the [Verify Authentication Server Name] checkbox, and enter the name of the authentication server to which the user is registered.

## 5 Configure the settings according to the authentication method to be used.

### ■ When using TLS

- 1 Select the [Use TLS] checkbox.
- 2 In [Name of Key to Use], click [Key and Certificate].
  - ⇒ The [Key and Certificate Settings] screen is displayed.
- 3 To the right of the key and certificate to use, click [Register Default Key].
  - Click the key name (or certificate icon) to display the certificate details.
  - On the certificate details screen, click [Verify Certificate] to verify that the certificate is valid.

### ■ When using TTLS or PEAP

- 1 Select the [Use TTLS] or [Use PEAP] checkbox.  
When using TTLS, select the internal protocol to be used.
- 2 Use [Use Login Name as User Name] to specify whether to use the login name of IEEE 802.1X authentication for the user name.
- 3 In [User Name/Password Settings], click [Change User Name/Password].
  - ⇒ The [Change User Name/Password] screen is displayed.
- 4 Set the user name and password, and select the [OK] checkbox.
  - Enter the user name using single-byte alphanumeric characters.
  - To set a password, select the [Change Password] checkbox, and enter the same password in both [Password] and [Confirm] using single-byte alphanumeric characters.

## 6 Click [OK].

## 7 Restart the machine. ▶ Restarting the Machine(P. 106)

⇒ The settings are applied.

# Managing and Verifying a Key and Certificate

---

94WS-085

To encrypt communication with TLS when using Remote UI, or to use TLS as the IEEE 802.1X authentication method, a key and certificate are required. In addition, depending on the communicating device, encrypted communication using a specified certificate may be requested, thereby requiring a key and certificate.

## Managing a Key and Certificate

---

You can prepare a key and certificate using the following methods:

### Generating a Key and Certificate on the Machine

Generate the key and certificate required for TLS on the machine. You can immediately communicate where self-signed certificates are allowed.

#### ▶ **Generating a Key and Certificate(P. 315)**

### Registering a Certificate Issued by a Certificate Authority in a Self-generated Key

When a key is generated on the machine, generate a Certificate Signing Request (CSR), have the certificate authority issue a certificate, and then register that certificate in the key.

#### ▶ **Generating a Key and Certificate Signing Request (CSR) and Obtaining and Registering a Certificate(P. 317)**

### Registering a Key and Certificate or CA Certificate Obtained from an Issuing Authority

Register a key and certificate obtained from an issuing authority or a CA certificate issued by a certificate authority, without self-generating the key and certificate. You can use a digital certificate that matches the communicating device and authentication level.

#### ▶ **Registering a Key and Certificate or CA Certificate Obtained from an Issuing Authority(P. 320)**

## Verifying a Certificate

---

You can configure the settings to verify the validity of a certificate that the machine receives from a certificate authority, using the Online Certificate Status Protocol (OCSP).

#### ▶ **Verifying a Received Certificate with OCSP(P. 322)**

# Generating a Key and Certificate

94WS-086

Generate the key and certificate required for TLS-encrypted communication on the machine. A self-signed certificate is used for the self-generated key.

For the algorithm of the keys and certificates that can be generated with this machine, see the specifications of the self-generated key and self-signed certificate. [▶Keys and Certificates\(P. 32\)](#)

Generate a key and certificate using Remote UI from a computer. You cannot use the operation panel to generate a key and certificate.

Administrator privileges are required.

## 1 Log in to Remote UI in System Manager Mode. [▶Starting Remote UI\(P. 349\)](#)

## 2 On the Portal page of Remote UI, click [Settings/Registration]. [▶Portal Page of Remote UI\(P. 351\)](#)

## 3 Click [Device Management] ▶ [Key and Certificate Settings] ▶ [Generate Key].

⇒ The [Generate Key] screen is displayed.

## 4 Select [Network Communication], and click [OK].

⇒ The [Generate Network Communication Key] screen is displayed.

## 5 In [Key Settings], enter the name of the key, and select the signature and key algorithm.

- Enter the key name using single-byte alphanumeric characters.
- For the key algorithm, select [RSA] or [ECDSA], and select the key length from the pulldown menu. The longer the key length, the better the security, but this slows down communication processing.

## 6 In [Certificate Settings], set the certificate information.

**[Validity Start Date (YYYY/MM/DD)]/[Validity End Date (YYYY/MM/DD)]**

Enter the start and end dates of the certificate validity period.

**[Country/Region]**

Select [Select Country/Region], and then select the country or region from the pulldown menu, or select [Enter Internet Country Code], and enter the country code.

**[State]/[City]/[Organization]/[Organization Unit]**

Enter the items as needed using single-byte alphanumeric characters.

**[Common Name]**

Enter the name of the certificate subject as needed using single-byte alphanumeric characters. This corresponds to the Common Name (CN).

## 7 Click [OK].

- ➡ The generated key and certificate are added to [Registered Key and Certificate] on the [Key and Certificate Settings] screen.

## **8 Log out from Remote UI.**

### **NOTE**

#### **Viewing and Verifying Detailed Information of a Generated Certificate**

- When you click the key name (or certificate icon) in [Registered Key and Certificate] on the [Key and Certificate Settings] screen, the certificate details appear.
- On the certificate details screen, click [Verify Certificate] to verify that the certificate is valid.

#### **When the Key and Certificate Cannot Be Deleted**

- You cannot delete a key and certificate being used. Disable the function being used, or delete these after switching to another key and certificate.

# Generating a Key and Certificate Signing Request (CSR) and Obtaining and Registering a Certificate

94WS-087

As a certificate generated on the machine does not have a signature from a certificate authority, the machine may not be able to communicate depending on the communicating device. In this case, registering a signed certificate issued by a certificate authority to the key enables communication even with a self-generated key.

For the certificate authority to issue a signed certificate, you must make a request attached with a Certificate Signing Request (CSR). The machine generates a CSR at the same time it generates a key.

For more information about the keys that can be generated by the machine and the CSR algorithm, see self-generated key and CSR specifications. [▶Keys and Certificates\(P. 32\)](#)

[▶Generating a Key and CSR\(P. 317\)](#)

[▶Registering a Certificate Issued by a Certificate Authority to a Key\(P. 318\)](#)

## Generating a Key and CSR

Generate a key and CSR using Remote UI from a computer. You cannot use the operation panel to generate a key and certificate.

Administrator privileges are required.

**1 Log in to Remote UI in System Manager Mode.** [▶Starting Remote UI\(P. 349\)](#)

**2 On the Portal page of Remote UI, click [Settings/Registration].** [▶Portal Page of Remote UI\(P. 351\)](#)

**3 Click [Device Management] ▶ [Key and Certificate Settings] ▶ [Generate Key].**

⇒ The [Generate Key] screen is displayed.

**4 Select [Key and Certificate Signing Request (CSR)], and click [OK].**

⇒ The [Generate Key and Certificate Signing Request (CSR)] screen is displayed.

**5 In [Key Settings], enter the name of the key, and select the signature algorithm and key algorithm.**

- Enter the key name using single-byte alphanumeric characters.
- For the key algorithm, select [RSA] or [ECDSA], and select the key length from the pulldown menu. The longer the key length, the better the security, but this slows down communication processing.

**6 In [Certificate Signing Request (CSR) Settings], set the CSR information.**

**[Country/Region]**

Select [Select Country/Region], and either select the country or region from the pulldown menu, or select [Enter Internet Country Code] and enter the country code.

**[State]/[City]/[Organization]/[Organization Unit]**

Enter the items as needed using single-byte alphanumeric characters.

**[Common Name]**

Enter the name of the certificate subject as needed using single-byte alphanumeric characters. This corresponds to the Common Name (CN).

**7 Click [OK].**

⇒ The [Key and Certificate Signing Request (CSR) Details] screen is displayed.

**8 Click [Store in File] to save the CSR file to a computer.****9 Log out from Remote UI.****10 Submit the application with CSR file attached to the certificate authority.****NOTE**

- When the CSR is generated, the key is registered to the machine, but it cannot be used until the certificate issued by the certificate authority is registered.

**Registering a Certificate Issued by a Certificate Authority to a Key**

Register the certificate using Remote UI from a computer. You cannot use the operation panel to register it. Administrator privileges are required.

**1 Log in to Remote UI in System Manager Mode. ▶ Starting Remote UI(P. 349)****2 On the Portal page of Remote UI, click [Settings/Registration]. ▶ Portal Page of Remote UI(P. 351)****3 Click [Device Management] ▶ [Key and Certificate Settings].**

⇒ The [Key and Certificate Settings] screen is displayed.

**4 Click the key name (or certificate icon) to which to register the certificate.**

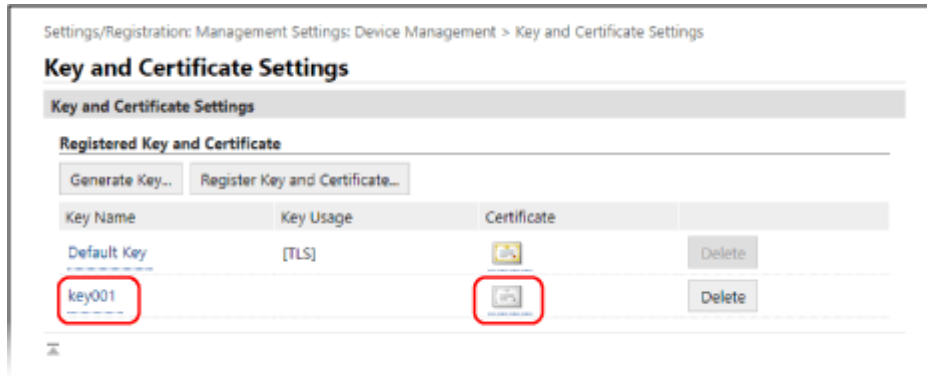



⇒ The [Key and Certificate Signing Request (CSR) Details] screen is displayed.

## 5 Click [Register Certificate].

## 6 In [Specify File], click [Browse], and specify the file of the certificate issued by the certificate authority.

## 7 Click [Register].

⇒ The icon of the certificate displayed in [Registered Key and Certificate] on the [Key and Certificate Settings] screen changes from [  ] to [  ].

## 8 Log out from Remote UI.

## NOTE

### Viewing and Verifying Detailed Information of a Registered Certificate

- Click the key name (or certificate icon) in [Registered Key and Certificate] on the [Key and Certificate Settings] screen to display the certificate details.
- On the certificate details screen, click [Verify Certificate] to verify that the certificate is valid.

### When the Key and Certificate Cannot Be Deleted

- You cannot delete a key and certificate being used. Disable the function being used, or delete these after switching to another key and certificate.



# Registering a Key and Certificate or CA Certificate Obtained from an Issuing Authority

94WS-08A

Install and register a key and certificate or CA certificate obtained from a digital certificate issuing authority to the machine before starting to use them.

Register the key and certificate or CA certificate using Remote UI from a computer. You cannot use the operation panel to register these. Administrator privileges are required.

## Required Preparations

- Check the conditions of the key and certificate or CA certificate usable with the machine. [▶Keys and Certificates\(P. 32\)](#)
- When registering a key and certificate, check the password for the private key set in the file.

### 1 Log in to Remote UI in System Manager Mode. [▶Starting Remote UI\(P. 349\)](#)

### 2 On the Portal page of Remote UI, click [Settings/Registration]. [▶Portal Page of Remote UI\(P. 351\)](#)

### 3 Click [Device Management] ▶ [Key and Certificate Settings] or [CA Certificate Settings].

⇒ The [Key and Certificate Settings] screen or [CA Certificate Settings] screen is displayed.

### 4 Click [Register Key and Certificate] or [Register CA Certificate].

⇒ The [Register Key and Certificate] screen or [Register CA Certificate] screen is displayed.

### 5 Install the key and certificate file or CA certificate file.

1 Click [Install].

2 Click [Browse] in [Specify File], and specify the file to be installed.

3 Click [Start Installation].

⇒ The installed file is added to [Installed Key and Certificate] on the [Register Key and Certificate] screen or [Installed CA Certificate] on the [Register CA Certificate] screen.

### 6 Registering the key and certificate or CA certificate.

#### ■ When registering a key and certificate

1 To the right of the key and certificate file to register, click [Register].

⇒ The [Enter Private Key Password] screen is displayed.

**2** Enter the key name password using single-byte alphanumeric characters, and click [OK].

⇒ The registered key and certificate are added to [Registered Key and Certificate] on the [Key and Certificate Settings] screen.

### ■ When registering a CA certificate

To the right of the CA certificate file to register, click [Register].

⇒ The registered CA certificate is added to [Registered CA Certificate] on the [CA Certificate Settings] screen.

## 7 Log out from Remote UI.

### NOTE

#### Viewing and Verifying Detailed Information of a Registered Certificate

- When you click the key name (or certificate icon) in [Registered Key and Certificate] on the [Key and Certificate Settings] screen, the certificate details appear.
- On the certificate details screen, click [Verify Certificate] to verify that the certificate is valid.

#### Viewing and Verifying Detailed Information of a Registered CA Certificate

- When you click the issued to location in [Registered CA Certificate] on the [CA Certificate Settings] screen, the CA certificate details appear.
- On the CA certificate details screen, click [Verify Certificate] to verify that the CA certificate is valid.

#### When the Key and Certificate or CA Certificate Cannot Be Deleted

- You cannot delete a key and certificate being used. Disable the function being used, or delete these after switching to another key and certificate.
- A preinstalled CA certificate cannot be deleted. If a preinstalled CA certificate is not required, click [Disable] to the right of the CA certificate.

# Verifying a Received Certificate with OCSP

94WS-08C

Online Certificate Status Protocol (OCSP) is a protocol for inquiring to an OCSP responder (server that supports OCSP) about the revocation status of a certificate received from a certificate authority. You can configure the settings to verify the validity of a certificate that the machine receives from a certificate authority, using the OCSP.

Configure these settings using Remote UI from a computer. You cannot use the operation panel to configure the settings. Administrator privileges are required.

- 1 Log in to Remote UI in System Manager Mode. ▶Starting Remote UI(P. 349)**
- 2 On the Portal page of Remote UI, click [Settings/Registration]. ▶Portal Page of Remote UI(P. 351)**
- 3 Click [Device Management] ▶ [OCSP (Online Certificate Status Protocol) Settings] ▶ [Edit].**

⇒ The [Edit OCSP (Online Certificate Status Protocol) Settings] screen is displayed.

- 4 Select the [Use OCSP (Online Certificate Status Protocol)] checkbox.**
- 5 Set the certificate verification level and the OCSP responder.**

#### [Certificate Verification Level]

Set whether to validate the certificate even if its revocation status cannot be confirmed, such as when the machine is unable to connect to an OCSP responder.

#### [OCSP Responder Settings]

Specify the URL of the OCSP responder.

#### [Custom URL]

When [Use Custom URL] or [Use Certificate URL (Use Custom URL If Certificate URL Cannot Be Retrieved)] is selected, enter the URL of the OCSP responder.

#### [Communication Timeout]

Enter the time from search start to timeout in seconds.

- 6 Click [OK].**

⇒ The settings are applied.

- 7 Log out from Remote UI.**

# Preventing Sending Data by Mistake and Leaking Information

---

94WS-08E

Unintentionally sending a fax to the wrong destination or leaving a printed document on the machine poses a risk of information leakage. In addition, while sending a fax from a computer and using mobile devices are easy and convenient, these can lead to operation errors and information theft.

You can take measures to prevent sending data by mistake and leaking information, according to the usage status of the function, to ensure safer use of the machine.

## **Restricting and Confirming the Destination**

You can restrict the destinations to which scanned data and faxes are sent and have a screen confirming the destination displayed when sending these.

- ▶ **Limiting Available Destinations(P. 324)**
- ▶ **Confirming the Destination before Sending(P. 326)**

## **Appropriately Restricting Functions**

You can restrict access to part or all of a function when sending a fax or using mobile devices.

- ▶ **Restricting Fax Sending(P. 328)**
- ▶ **Restricting Use from a Mobile Device(P. 340)**

## **Preventing Unattended Printed Documents and Information Theft**

You can store print data sent from a computer or received faxes on the machine without printing them immediately.

- ▶ **Restricting Printing (Touch Panel Model)(P. 330)**

# Limiting Available Destinations

94WS-08F

You can prevent sending faxes or scanned data by mistake and leaking data by not allowing users to use destinations in the send function log and by limiting send destinations to those registered in the Address Book.

- ▶ **Prohibiting the Use of Destinations in the Send Log(P. 324)**
- ▶ **Sending Only to Registered Destinations(P. 325)**

## IMPORTANT

### You cannot limit destinations for faxes sent by computer.

- Even when the use of new destinations or destinations from the send function log is prohibited, users can send faxes from a computer (PC faxing) to a destination of their choice. To more strictly limit the available destinations, you must also prohibit the sending of faxes from the computer. ▶ **Prohibit Fax Sending from a Computer(P. 328)**

## Prohibiting the Use of Destinations in the Send Log

Prevent specifying destinations in the TX Job Log of scan or fax jobs.

This section describes how to configure the settings using Remote UI from a computer.

On the operation panel, select [Menu] in the [Home] screen, and then select [Function Settings] to configure the settings. ▶ **[Restrict Resending from Log](P. 431)**

Administrator privileges are required.

- 1 Log in to Remote UI in System Manager Mode. ▶ Starting Remote UI(P. 349)**
- 2 On the Portal page of Remote UI, click [Settings/Registration]. ▶ Portal Page of Remote UI(P. 351)**
- 3 Click [TX Settings] ▶ [Common Settings] ▶ [Edit].**
  - ⇒ The [Edit Common Settings] screen is displayed.
- 4 In [Common Settings], select the [Restrict Resending from Log] checkbox.**
- 5 Click [OK].**
  - ⇒ The settings are applied.
- 6 Log out from Remote UI.**

## Sending Only to Registered Destinations

This limits the available send destinations to the following:

- Destinations in the Address Book.

When this function is enabled, users cannot enter a destination using the numeric keys or register or edit the Address Book. In addition, the TX Job Log recorded before enabling this function is deleted, leaving only the aforementioned available destinations in the TX Job Log.

This section describes how to configure the settings using Remote UI from a computer.

On the operation panel, select [Menu] in the [Home] screen, and then select [Function Settings] to configure the settings. ▶**[Restrict New Destinations](P. 431)**

Administrator privileges are required.

- 1 Log in to Remote UI in System Manager Mode.** ▶**Starting Remote UI(P. 349)**
- 2 On the Portal page of Remote UI, click [Settings/Registration].** ▶**Portal Page of Remote UI(P. 351)**
- 3 Click [TX Settings] ▶ [Restrict New Destinations] ▶ [Edit].**  
⇒ The [Edit Settings for New Destinations Restrictions] screen is displayed.
- 4 Select the [Restrict New Destinations] checkbox.**
- 5 Click [OK].**  
⇒ The settings are applied.
- 6 Log out from Remote UI.**

# Confirming the Destination before Sending

94WS-08H

Configure the settings to display a screen confirming the destination before a fax is sent. Confirm that there are no mistakes in the specified destination and entered information to prevent sending by mistake.

## Choosing When to Display the Confirmation Screen

- **When specifying a destination with a coded dial number**  
When a destination is specified with a coded dial number, the registered destination and destination name are displayed on the confirmation screen. When a group is registered to a coded dial number, the group name and number of destinations are displayed.
- **When sending a fax**  
When you press [Start] to send a fax, a screen confirming the destination is displayed. Set whether to display this only when sending to multiple destinations (Sequential Broadcast) or whenever sending a fax.
- **When entering a fax number using the numeric keys**  
When you enter a fax number using the numeric keys and press [Start], a screen appears prompting you to enter the number again. When you enter a second and subsequent destinations, they are displayed before the next destination is entered.

This section describes how to configure the settings using Remote UI from a computer. On the operation panel, select [Menu] in the [Home] screen, and then select [Function Settings] to configure the settings. ▶[Common Settings] (Touch Panel Model)(P. 431) / ▶[Confirm Entered Fax Number](P. 438) Administrator privileges are required.

## 1 Log in to Remote UI in System Manager Mode. ▶Starting Remote UI(P. 349)

## 2 On the Portal page of Remote UI, click [Settings/Registration]. ▶Portal Page of Remote UI(P. 351)

## 3 Click [TX Settings].

⇒ The [TX Settings] screen is displayed.

## 4 Configure the setting so that the screen confirming the destination is displayed.

### ■To display the screen when specifying the destination using a coded dial number

#### 1 Click [Common Settings] ▶ [Edit].

⇒ The [Edit Common Settings] screen is displayed.

#### 2 In [Common Settings], select the [Confirm When Using One-Touch/Coded Dial TX] checkbox.

#### 3 Click [OK].

### ■To display the screen when sending a fax

#### 1 Click [Common Settings] ▶ [Edit].

⇒ The [Edit Common Settings] screen is displayed.

- 2 In [Common Settings], select the [Confirm Destination Before Sending] checkbox, and select the item to display.
- 3 Click [OK].

■ **To display the screen when entering a fax number using the numeric keys**

- 1 Click [Fax TX Settings] ► [Edit].  
    ⇒ The [Edit Fax TX Settings] screen is displayed.
- 2 In [Basic Settings], select the [Confirm Entered Fax Number] checkbox.
- 3 Click [OK].

**5 Log out from Remote UI.**



# Restricting Fax Sending

You can prohibit fax sending from a computer (PC faxing) and the function for collectively sending a fax to multiple destinations (Sequential Broadcast) to prevent information leakage via fax.

- ▶ **Prohibit Fax Sending from a Computer(P. 328)**
- ▶ **Prohibiting Fax Sending to Multiple Destinations(P. 328)**

## Prohibit Fax Sending from a Computer

You can prohibit users from sending a fax from a fax driver, thereby disabling PC faxing.

This section describes how to configure the settings using Remote UI from a computer. On the operation panel, select [Menu] in the [Home] screen, and then select [Function Settings] to configure the settings. ▶ **[Allow Fax Driver TX](P. 438)**  
Administrator privileges are required.

- 1 Log in to Remote UI in System Manager Mode. ▶ Starting Remote UI(P. 349)**
- 2 On the Portal page of Remote UI, click [Settings/Registration]. ▶ Portal Page of Remote UI(P. 351)**
- 3 Click [TX Settings] ▶ [Fax TX Settings] ▶ [Edit].**  
 ▶ The [Edit Fax TX Settings] screen is displayed.
- 4 In [Basic Settings], clear the [Allow Fax Driver TX] checkbox.**
- 5 Click [OK].**  
 ▶ The settings are applied.
- 6 Log out from Remote UI.**

## Prohibiting Fax Sending to Multiple Destinations

This section describes how to configure the settings using Remote UI from a computer. On the operation panel, select [Menu] in the [Home] screen, and then select [Function Settings] to configure the settings. ▶ **[Restrict Sequential Broadcast](P. 439)**  
Administrator privileges are required.

- 1 Log in to Remote UI in System Manager Mode. ▶ Starting Remote UI(P. 349)**

**2** On the Portal page of Remote UI, click [Settings/Registration]. ▶ Portal Page of Remote UI(P. 351)

**3** Click [TX Settings] ▶ [Fax TX Settings] ▶ [Edit].

⇒ The [Edit Fax TX Settings] screen is displayed.

**4** In [Basic Settings], set [Restrict Sequential Broadcast] to [Reject Sequential Broadcast].

**5** Click [OK].

⇒ The settings are applied.

**6** Log out from Remote UI.

## Restricting Printing (Touch Panel Model)

---

94WS-08R

You can require users not to immediately print received faxes. This can prevent not only unattended printed documents and information theft, but also unneeded printing, thereby saving paper.

▶ **Saving Received Documents in the Machine (Memory Lock) (Touch Panel Model)(P. 331)**

# Saving Received Documents in the Machine (Memory Lock) (Touch Panel Model)

94WS-08U

Memory Lock temporarily saves received faxes in the memory of the machine without printing them immediately. Faxes saved in the memory can be printed later, thereby preventing unattended printed documents and information theft. In addition, unneeded faxes can be deleted without printing to help save paper.

▶ **Setting Memory Lock**(P. 331)

▶ **Viewing and Printing Faxes Saved in the Memory**(P. 332)

## Setting Memory Lock

This section describes how to configure the settings using Remote UI from a computer. On the operation panel, select [Menu] in the [Home] screen, and then select [Function Settings] to configure the settings. ▶ **[Fax Memory Lock Settings]**(P. 442)  
Administrator privileges are required.

- 1 Log in to Remote UI in System Manager Mode.** ▶ **Starting Remote UI**(P. 349)
- 2 On the Portal page of Remote UI, click [Settings/Registration].** ▶ **Portal Page of Remote UI**(P. 351)
- 3 In [RX/Forwarding Settings], click [Common Settings].**
  - ⇒ The [Common Settings] screen is displayed.
- 4 In [Memory Lock Settings], click [Edit].**
  - ⇒ The [Edit Memory Lock Settings] screen is displayed.
- 5 Select the [Use Memory Lock] checkbox.**
- 6 Configure the functions related to Memory Lock, as needed.**

### ■ To enable fax preview

Select the [Use Fax Preview] checkbox.

You can preview the fax on Remote UI. When you enable preview, you can also see the details of the fax and print with the Memory Lock setting enabled.

\* This cannot be set at the same time as [Specify Memory Lock Time].

### ■ To print an RX Result Report to provide notification of Memory Lock

Select the [Print Report] checkbox.

\* To use this function, RX Result Report must be enabled. ▶ **Printing and Viewing Reports and Lists**(P. 358)

### ■ To enable Memory Lock only at a specified time period

Select the [Specify Memory Lock Time] checkbox and enter a start and end time.

## 7 Click [OK].

⇒ The settings are applied.

## 8 Log out from Remote UI.

### ! IMPORTANT

- When Memory Lock is disabled, all faxes saved in the memory are printed automatically. Memory Lock is disabled in the following cases:
  - When the [Use Memory Lock] checkbox is cleared
  - When the end time of [Specify Memory Lock Time] has been reached

## Viewing and Printing Faxes Saved in the Memory

When you enable preview in Memory Lock, you can see the details of the fax and print with the Memory Lock setting enabled.

This section describes how to view this information and print using Remote UI from a computer. On the operation panel, press  to view this information. You cannot use the operation panel to view some items. In addition, you cannot use the operation panel to print documents. **▶Checking the Status and Log for Sent and Received Faxes(P. 236)**  
Administrator privileges are required.

## 1 Log in to Remote UI in System Manager Mode. ▶Starting Remote UI(P. 349)

## 2 On the Portal page of Remote UI, click [Status Monitor/Cancel]. ▶Portal Page of Remote UI(P. 351)

## 3 In [RX], click [Job Status].

⇒ The [RX: Job Status] screen is displayed.

## 4 View or print the fax.

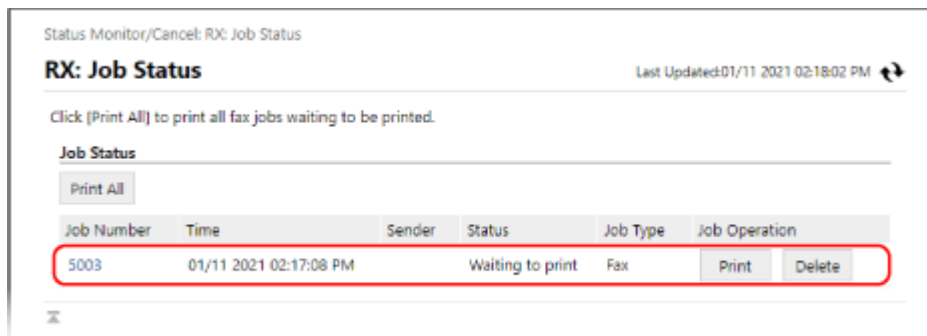

Status Monitor/Cancel: RX: Job Status

**RX: Job Status** Last Updated:01/11 2021 02:18:02 PM ↻

Click [Print All] to print all fax jobs waiting to be printed.

Job Status

Job Number	Time	Sender	Status	Job Type	Job Operation
5003	01/11 2021 02:17:08 PM		Waiting to print	Fax	<input type="button" value="Print"/> <input type="button" value="Delete"/>

- When you click the job number, the [Job Details] screen is displayed. You can view the reception time and number of pages, and preview the fax.

- When you click [Print All], all faxes saved in the memory are printed.

**5 Log out from Remote UI after viewing the information or printing.**

# Preventing Unauthorized Use

---

94WS-08W

The machine handles a variety of information including the Address Book. It also provides various settings to ensure efficient management and operation. While this information and the settings provide convenience, they can also lead to information leakage and other security issues if the information and settings can be accessed by anyone. You can take measures to restrict access and disable functions according to the usage status of the function, to ensure safer use of the machine.

## Restricting Access to Information and Settings

Restricting users and operations accessing information and settings on the machine can help prevent unauthorized use and protect confidential information.

- ▶ **Restricting Address Book Registration and Editing (Touch Panel Model)(P. 335)**
- ▶ **Restricting Use of Remote UI(P. 337)**
- ▶ **Restricting Use from a Mobile Device(P. 340)**

## Disabling Unused Functions

You can disable unused functions to prevent intrusion from the outside.

- ▶ **Preventing Connection to Computer via USB Port(P. 341)**
- ▶ **Configuring LPD, RAW, or WSD(P. 342)**
- ▶ **Disabling HTTP Communication(P. 344)**

## ■ See Also

For details about the administrator account, see the following.

- ▶ **Setting the Department ID and PIN for the Administrator(P. 301)**

# Restricting Address Book Registration and Editing (Touch Panel Model)

94WS-08X

To prevent unauthorized adding of new entries in the Address Book and editing of existing entries, you can set a PIN and restrict the method for adding new entries.

- ▶ **Restricting Address Book Registration and Editing by Setting a PIN(P. 335)**
- ▶ **Prohibiting Registering Fax Sending Log Destinations to Address Book(P. 336)**

## NOTE

- To better prevent sending data by mistake and information leakage, allow to send only to registered destinations, and prohibit the adding and editing of entries in the Address Book. ▶ **Limiting Available Destinations(P. 324)**

## Restricting Address Book Registration and Editing by Setting a PIN

You can require the entry of PIN to add a new entry to the Address Book or edit existing entries.

This section describes how to configure the settings using Remote UI from a computer.

On the operation panel, select [Menu] in the [Home] screen, and then select [Set Destination] to configure the settings.

▶ **[Address Book PIN](P. 448)**

Administrator privileges are required.

- 1 Log in to Remote UI in System Manager Mode.** ▶ **Starting Remote UI(P. 349)**
- 2 On the Portal page of Remote UI, click [Settings/Registration].** ▶ **Portal Page of Remote UI(P. 351)**
- 3 Click [Address Book PIN] ▶ [Edit].**
  - ⇒ The [Edit Address Book PIN] screen is displayed.
- 4 Select the [Set/Change PIN] checkbox, and set a PIN.**
  - Enter the same number in [Address Book PIN] and [Confirm].
  - \* You cannot set a PIN consisting of all zeros, such as "00" or "0000000."
- 5 Click [OK].**
  - ⇒ The settings are applied.
- 6 Log out from Remote UI.**

## NOTE



## Clearing the PIN Setting

- Clear the entered values of [Address Book PIN], and then click [OK] with the fields left empty.

## Prohibiting Registering Fax Sending Log Destinations to Address Book

You can restrict the registration of destinations in the fax sending log to Address Book.

This section describes how to configure the settings using Remote UI from a computer. On the operation panel, select [Menu] in the [Home] screen, and then select [Function Settings] to configure the settings. ▶[Register Log Dest to Addr Book](P. 439)  
Administrator privileges are required.

- 1 Log in to Remote UI in System Manager Mode.** ▶Starting Remote UI(P. 349)
- 2 On the Portal page of Remote UI, click [Settings/Registration].** ▶Portal Page of Remote UI(P. 351)
- 3 Click [TX Settings] ▶ [Fax TX Settings] ▶ [Edit].**  
⇒ The [Edit Fax TX Settings] screen is displayed.
- 4 Select the [Restrict Registration of Log Destinations to Address Book] checkbox.**
- 5 Click [OK].**  
⇒ The settings are applied.
- 6 Log out from Remote UI.**

# Restricting Use of Remote UI

94WS-08Y

While Remote UI is convenient for operating the machine from a computer, it also poses a risk of third-party access to the machine.

You can configure the setting to require users to enter a PIN (Remote UI Access PIN) when using Remote UI to prevent unauthorized access by a third party.

If you do not use Remote UI, it is recommended that you disable the function.

▶ **Setting the PIN to Use for Remote UI(P. 337)**

▶ **Disabling Remote UI(P. 338)**

## Setting the PIN to Use for Remote UI

You can restrict the use of Remote UI to only those users who know the Remote UI Access PIN.

This section describes how to configure the settings using the operation panel.

You can also configure the settings using Remote UI from a computer after the Remote UI Access PIN has been set on the machine. ▶ **Managing the Machine from a Computer (Remote UI)(P. 348)**

Administrator privileges are required.

▶ **Touch Panel Model(P. 337)**

▶ **5 Lines LCD Model(P. 337)**

### ■ Touch Panel Model

**1** On the operation panel, press [Menu] in the [Home] screen. ▶ **[Home] Screen(P. 113)**

**2** Press [Management Settings] ▶ [Remote UI Settings/Update Firmware] ▶ [Remote UI Settings] ▶ [Remote UI Access Security Settings].

⇒ The [RUI Access Security] screen is displayed.

If the login screen appears, enter the System Manager ID and PIN, and then press [Log In]. ▶ **System Manager ID and PIN(P. 6)**

**3** Set [Remote UI Access Security Settings] to [On], enter the Remote UI Access PIN, and press [Apply].

**4** Enter the same number, and press [Apply].

⇒ The settings are applied.

### ■ 5 Lines LCD Model

**1** On the operation panel, select [Menu] in the [Home] screen, and press **OK**. ▶ **[Home] Screen(P. 113)**

- 2 Press [Management Settings] ► **OK** ► [Remote UI Settings/Update Firmware] ► **OK** ► [Remote UI Settings] ► **OK** ► [Remote UI Access Security Settings] ► **OK**.

⇒ The [RUI Access Security] screen is displayed.

If the login screen appears, enter the System Manager ID and PIN, and then press [<Log In>] ► **OK**. 

**System Manager ID and PIN(P. 6)**

- 3 Set [Remote UI Access Security Settings] to [On], enter the Remote UI Access PIN, and press **OK**.

- 4 Enter the same number, and press **OK**.

⇒ The settings are applied.

## NOTE

### When [Management Settings] of the Settings Menu Is Initialized

- Use the settings menu on the operation panel to reset the Remote UI Access PIN.  **[Remote UI Access Security Settings](P. 456)**

## Disabling Remote UI

You can disable Remote UI to reduce the risk of unauthorized access to the machine via the network.

Use the operation panel to configure the settings. You cannot configure the settings using Remote UI from a computer.

Administrator privileges are required. The machine must be restarted to apply the settings.

-  **Touch Panel Model(P. 338)**
-  **5 Lines LCD Model(P. 339)**

### ■ Touch Panel Model

- 1 On the operation panel, press [Menu] in the [Home] screen.  **[Home] Screen(P. 113)**

- 2 Press [Management Settings] ► [Remote UI Settings/Update Firmware] ► [Remote UI Settings] ► [Remote UI Access Security Settings].

⇒ The [Use Remote UI] screen is displayed.

If the login screen appears, enter the System Manager ID and PIN, and then press [Log In].  **System Manager ID and PIN(P. 6)**

- 3 Set [Use Remote UI] to [Off].

## 4 Restart the machine. ▶ Restarting the Machine(P. 106)

⇒ The settings are applied.

### ■ 5 Lines LCD Model

#### 1 On the operation panel, select [Menu] in the [Home] screen, and press **OK**. ▶ [Home] Screen(P. 113)

#### 2 Press [Management Settings] ▶ **OK** ▶ [Remote UI Settings/Update Firmware] ▶ **OK** ▶ [Remote UI Settings] ▶ **OK**.

⇒ The [Remote UI Settings] screen is displayed.

If the login screen appears, enter the System Manager ID and PIN, and then press [<Log In>] ▶ **OK**. ▶ System Manager ID and PIN(P. 6)

#### 3 Press [Use Remote UI] ▶ **OK** ▶ [Off] ▶ **OK**.

#### 4 Restart the machine. ▶ Restarting the Machine(P. 106)

⇒ The settings are applied.

# Restricting Use from a Mobile Device

94WS-08L

The machine supports the Mopria® plugin, which is supported by various manufacturers.

Mopria® enables printing from any application, such as on a smartphone, or a device equipped with Chrome OS without having to install a dedicated Canon plugin.

Printing from a mobile device can be easy and convenient, but it can also lead to information leakage. You can also prohibit use of Mopria®.

Configure this setting using Remote UI from a computer. You cannot use the operation panel to configure the setting. Administrator privileges are required.

## 1 Log in to Remote UI in System Manager Mode. Starting Remote UI(P. 349)

## 2 On the Portal page of Remote UI, click [Settings/Registration]. Portal Page of Remote UI(P. 351)

## 3 Click [Network Settings] ▶ [Mopria Settings] ▶ [Edit].





⇒ The [Edit Mopria Settings] screen is displayed.

## 4 Clear the [Use Mopria] checkbox, and click [OK].

⇒ The settings are applied.

## 5 Log out from Remote UI.

### NOTE

- When the Mopria® setting is enabled, the following network settings are also enabled:
  - HTTP  [Use HTTP](P. 398)
  - IPP printing  [IPP Print Settings](P. 398)
  - mDNS (IPv4)  [mDNS Settings](P. 394)
  - mDNS (IPv6)  [mDNS Settings](P. 394)
  - Network Link Scan  [Network Link Scan Settings](P. 398)

# Preventing Connection to Computer via USB Port

---

94WS-090

You can disable the USB port for computer connection on the back of the machine to reduce the risk of an external connection without going through a network with security measures.

This section describes how to configure the settings using Remote UI from a computer.

On the operation panel, select [Menu] in the [Home] screen, and then select [Preferences] to configure the settings. ▶  
**[USB Settings](P. 400)**

Administrator privileges are required. The machine must be restarted to apply the settings.

**1 Log in to Remote UI in System Manager Mode. ▶Starting Remote UI(P. 349)**

**2 On the Portal page of Remote UI, click [Settings/Registration]. ▶Portal Page of Remote UI(P. 351)**

**3 Click [External Interface Settings] ▶ [Edit].**

⇒ The [Edit External Interface Settings] screen is displayed.

**4 Clear the [Use as USB Device] checkbox, and click [OK].**

**5 Restart the machine. ▶Restarting the Machine(P. 106)**

⇒ The settings are applied.

## Configuring LPD, RAW, or WSD

94WS-091

Select whether to use any of the protocols below on the machine when printing or scanning documents from a computer.

You are recommended to disable any protocols you will not be using.

When using LPD or RAW, you can configure the time until reception of print data is canceled.

### LPD

This protocol is not dependent on the hardware, operating system, or other platform. It is commonly used in TCP/IP network environments.

### RAW

This is Windows' proprietary print data type protocol. It is used as standard in a Windows environment.

### WSD

This protocol enables automatic detection of network-connected printers and scanners in a Windows environment.

This section describes how to configure the settings using Remote UI from a computer.

On the operation panel, select [Menu] in the [Home] screen, and then select [Preferences] to configure the settings. ▶  
[TCP/IP Settings](P. 393)

Administrator privileges are required. The machine must be restarted to apply the settings.

- 1 Log in to Remote UI in System Manager Mode. ▶Starting Remote UI(P. 349)
- 2 On the Portal page of Remote UI, click [Settings/Registration]. ▶Portal Page of Remote UI(P. 351)
- 3 Click [Network Settings].
- 4 Configure LPD, RAW, or WSD.

### ■When Configuring LPD

- 1 Click [LPD Settings] ▶ [Edit].  
⇒ The [Edit LPD Settings] screen is displayed.
- 2 Set whether to use LPD.  
When not using LPD, clear the [Use LPD Printing] checkbox, and proceed to step 5.
- 3 Enter the time in [RX Timeout].  
Enter the time in minutes from the start of reception standby, after print data reception is canceled, to the timeout.

### ■When Configuring RAW

- 1 Click [RAW Settings] ▶ [Edit].  
⇒ The [Edit RAW Settings] screen is displayed.
- 2 Set whether to use RAW.

When not using RAW, clear the [Use RAW Printing] checkbox, and proceed to step 5.

- 3 Enter the time in [RX Timeout].  
Enter the time in minutes from the start of reception standby, after print data reception is canceled, to the timeout.

### ■ When Configuring WSD

- 1 Click [WSD Settings] ► [Edit].  
 ►► The [Edit WSD Settings] screen is displayed.
- 2 Set whether to use WSD for each function.  
When not using WSD, clear the checkbox of the function for restricting use of WSD.

#### Using WSD to Print Data

Select the [Use WSD Printing] checkbox.

The [Use WSD Browsing] checkbox is selected automatically, and WSD is used to obtain the information of the machine from the computer.

#### Using WSD to Scan Data

Select the [Use WSD Scanning] checkbox. You can perform scanning from a computer without having to install a scanner driver.

To be able to specify a computer connected via WSD as the store location when scanning from the machine, also select the [Use Computer Scanning] checkbox.

#### When Responding to a Search Request of the Machine by Multicast Discovery

Select the [Use Multicast Discovery] checkbox.

To keep the machine in sleep mode without responding to received multicast discovery packets, clear the checkbox.



- 5 Click [OK].

- 6 Restart the machine. ► **Restarting the Machine(P. 106)**

►► The settings are applied.

## NOTE

### Adding a WSD Network Device

- Click [] (Start) ► [] (Settings) ► [Devices] ► [Printers & scanners] ► [Add printers & scanners], and perform the operations following the instructions on the screen.
- For details about installing the driver via a WSD network, see the manual of the driver at the online manual site.  
<https://oip.manual.canon/>

### Changing the Port Number

- To change the port number of each protocol, see the following:  
► **Changing the Port Number(P. 307)**



# Disabling HTTP Communication

94WS-092

It is recommended to disable HTTP communication when using only the USB connection or when not using functions that require HTTP communication, such as Remote UI, WSD printing, and AirPrint.

This section describes how to configure the settings using the operation panel.

You can also configure the settings using Remote UI from a computer. [▶Managing the Machine from a Computer \(Remote UI\)\(P. 348\)](#)

Administrator privileges are required.

[▶Touch Panel Model\(P. 344\)](#)

[▶5 Lines LCD Model\(P. 344\)](#)

## Touch Panel Model

**1** On the operation panel, press [Menu] in the [Home] screen. [▶\[Home\] Screen\(P. 113\)](#)

**2** Press [Preferences] ▶ [Network] ▶ [TCP/IP Settings] ▶ [Use HTTP].

⇒ The [Use HTTP] screen is displayed.

If the login screen appears, enter the System Manager ID and PIN, and then press [Log In]. [▶System Manager ID and PIN\(P. 6\)](#)

**3** Press [Off] ▶ [Yes].

## 5 Lines LCD Model

**1** On the operation panel, select [Menu] in the [Home] screen, and press **OK**. [▶\[Home\] Screen\(P. 113\)](#)

**2** Press [Preferences] ▶ **OK** ▶ [Network] ▶ **OK** ▶ [TCP/IP Settings] ▶ **OK** ▶ [Use HTTP] ▶ **OK**.

⇒ The [Use HTTP] screen is displayed.

If the login screen appears, enter the System Manager ID and PIN, and then press [<Log In>] ▶ **OK**. [▶System Manager ID and PIN\(P. 6\)](#)

**3** Press [Off] ▶ **OK** ▶ [Yes] ▶ **OK**.

# Managing the Machine

<b>Managing the Machine</b> .....	346
<b>Setting the Date and Time</b> .....	347
<b>Managing the Machine from a Computer (Remote UI)</b> .....	348
Starting Remote UI .....	349
Portal Page of Remote UI .....	351
Checking Usage and Logs with Remote UI .....	353
<b>Monitoring the Usage</b> .....	355
Checking the Number of Printed Pages (Check Counter) .....	356
Printing and Viewing Reports and Lists .....	358
Changing the Report and List Print Settings .....	361
<b>Importing and Exporting the Address Book (Touch Panel Model)</b> .....	363
<b>Updating the Firmware (Touch Panel Model)</b> .....	365
<b>Updating the Firmware (5 Lines LCD Model)</b> .....	368
<b>Initializing the Settings and Data</b> .....	371

# Managing the Machine

---

94WS-095

This section describes the management functions that are required to operate the machine.

## Monitoring the Operation Status and Usage of the Machine, and Configuring the Settings

---

### Setting the Date and Time

Set the date and time for the machine. The date and time are used as the reference for the functions using date and time information, and therefore, they need to be set accurately.

▶ **Setting the Date and Time(P. 347)**

### Checking the Operation Status and Changing the Settings (Remote UI)

You can use a Web browser on a computer to check the operation status of the machine, change the machine settings, and register destinations to the Address Book. You can manage the machine from a remote location and efficiently perform time-consuming settings and registration on your computer.

▶ **Managing the Machine from a Computer (Remote UI)(P. 348)**

### Monitoring the Usage (Operation Panel)

You can use the operation panel of the machine to check the total number of printed pages and print communication results, settings, and other reports and lists.

▶ **Monitoring the Usage(P. 355)**

## Managing Servers, Various Data, and Firmware

---

### Managing the Address Book

You can use the import and export functions to regularly back up the Address Book. In addition, you can share the Address Book with other devices to save time on registering destinations and configuring the settings.

▶ **Importing and Exporting the Address Book (Touch Panel Model)(P. 363)**

### Updating the Firmware

Update the firmware to add new functions to the machine and to fix bugs. By updating to the latest firmware, you can use the machine with more stable and comfortable operations.

▶ **Updating the Firmware (Touch Panel Model)(P. 365)**

▶ **Updating the Firmware (5 Lines LCD Model)(P. 368)**

### Initializing the Settings and Data

You can initialize all settings and data when replacing or disposing of the machine. Initializing the machine prevents access to confidential information and unauthorized use by third parties.

▶ **Initializing the Settings and Data(P. 371)**

## ■ See Also

For the settings required to operate the machine, such as the network settings and fax settings, see the following:

▶ **Setting Up(P. 41)**

# Setting the Date and Time

---

94WS-096

Set the date and time for the machine. The date and time set here are used as the reference for the functions using date and time information, and therefore, they need to be set accurately.

This section describes how to configure the settings using Remote UI from a computer.

On the operation panel, select [Menu] in the [Home] screen, and then select [Preferences] to configure the settings. ▶  
[Timer/Energy Settings](P. 383)

## 1 Log in to Remote UI. ▶Starting Remote UI(P. 349)

## 2 On the Portal page of Remote UI, click [Settings/Registration]. ▶Portal Page of Remote UI(P. 351)

## 3 Click [Timer Settings] ▶ [Edit].

⇒ The [Edit Timer Settings] screen is displayed.

## 4 Enter the current date and time.

## 5 Set the time zone according to the region where the machine is used.

Communicating over the Internet is premised on setting the UTC (Coordinated Universal Time) correctly. The UTC is a coordinated universal time that is standard for all parts of the world. There is a time difference depending on the country or region where the machine is used.

## 6 Set daylight saving time as needed.

- Select the [Use Daylight Saving Time] checkbox if the machine is in a country or region with daylight saving time, and then set the start and end dates.

## 7 Click [OK].

⇒ The settings are applied.

## 8 Log out from Remote UI.

# Managing the Machine from a Computer (Remote UI)

---

94WS-097

With Remote UI, you can use a Web browser on a computer to check the function operation status of the machine, change the machine settings, and register destinations to the Address Book. You can manage the machine from a remote location and efficiently perform time-consuming settings and registration on your computer.

Remote UI has the following two modes. The functions available with Remote UI vary depending on the mode you logged in to.

- **System Manager Mode**  
You can use all functions of Remote UI.
- **General User Mode**  
You can monitor usage, view logs, cancel printing, and change some settings.

- ▶ **Starting Remote UI(P. 349)**
- ▶ **Portal Page of Remote UI(P. 351)**
- ▶ **Checking Usage and Logs with Remote UI(P. 353)**

## ■ See Also

It is recommended that you set up the following functions to prevent unauthorized use of Remote UI by a third party:

### **System Manager ID**

Set the System Manager ID, which is the exclusive administrator account, so that only users with the ID can log in to System Manager Mode.

- ▶ **Setting the Department ID and PIN for the Administrator(P. 301)**

### **Remote UI Access PIN**

Configure this setting to require PIN entry when logging in to Remote UI so that only users with the PIN can use Remote UI.

- ▶ **Setting the PIN to Use for Remote UI(P. 337)**

# Starting Remote UI

94WS-098

To use Remote UI, enter the IP address of the machine into a Web browser on a computer, and log in with System Manager Mode or General User Mode. The functions available with Remote UI vary depending on the mode you logged in to.

## Required Preparations

- Check the operating environment of Remote UI. [▶Supported Environment\(P. 35\)](#)
- Connect the computer you are using to operate Remote UI to the machine over a network. [▶Setting Up the Network\(P. 49\)](#)
- Check the IP address of the machine. [▶Checking the Network Status and Settings\(P. 88\)](#)

## 1 From a Web browser on a computer, access the following URL.

http://<IP address of the machine>/

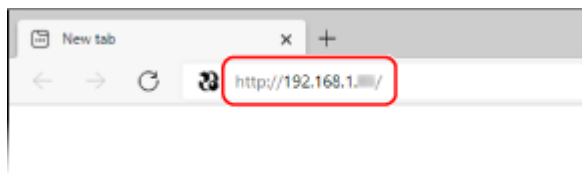

⇒ The Remote UI login screen appears.

When Remote UI communication is encrypted, a warning message about the security certificate may appear. If there are no problems with the certificate or TLS settings, you can continue operations.

When entering an IPv6 address, enclose the IP address in brackets [ ].

### Example:

http://[fe80:2e9e:fcff:fe4e:dbce]/

## ■ If the Remote UI Login Screen Is Not Displayed

When a message such as [Cannot access Remote UI.] is displayed and the login screen is not displayed, see the following:

- [Cannot Access Remote UI\(P. 556\)](#)

## 2 Select [System Manager Mode] or [General User Mode], and enter the items required for login.

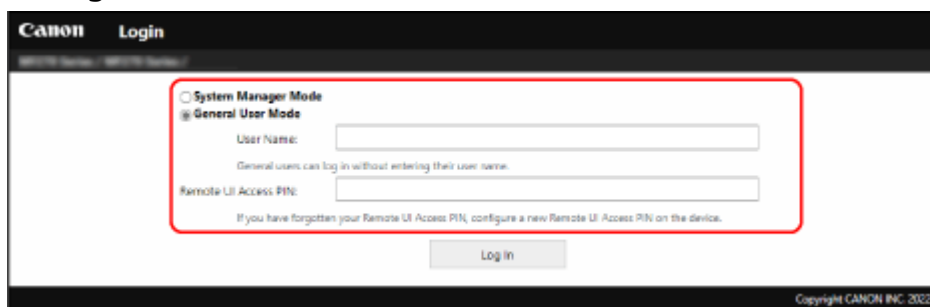

### [System Manager Mode]

When the System Manager ID is set, enter the System Manager ID and System Manager PIN. [▶System Manager ID and PIN\(P. 6\)](#)

\* When logging in with System Manager Mode, you must change the System Manager PIN from the default setting. ▶ **Setting the Department ID and PIN for the Administrator(P. 301)**

**[General User Mode]**

You can log in without entering a user name, but enter a print user name when checking and canceling jobs waiting to be printed.

\* If a user name is not set in the printer driver, the logon user name of the computer that sent the print data is set automatically.

**[Remote UI Access PIN]**

When the Remote UI Access PIN is set, enter the PIN.

### 3 Click [Log In].

⇒ The Portal page of Remote UI appears. ▶ **Portal Page of Remote UI(P. 351)**

### 4 When you have completed your operations, click [Log Out].

⇒ The login screen appears after logging out from Remote UI.

## IMPORTANT

- Do not access other websites when using Remote UI.

## NOTE

### Setting the Time Until the User Is Automatically Logged Out

- The user is automatically logged out from Remote UI if no operations are performed for a certain period of time. Use the following procedure to set the time until the user is logged out.

Log in to Remote UI in System Manager Mode ▶ [Settings/Registration] ▶ [Network Settings] ▶ [Session Settings] ▶ [Edit] ▶ enter the time until the user is logged out ▶ [OK]

## Portal Page of Remote UI

94WS-099

When you log in to Remote UI, the Portal page (Remote UI top page) appears. From here you can check the operations status of the machine, view various information, and change the settings with button operations.

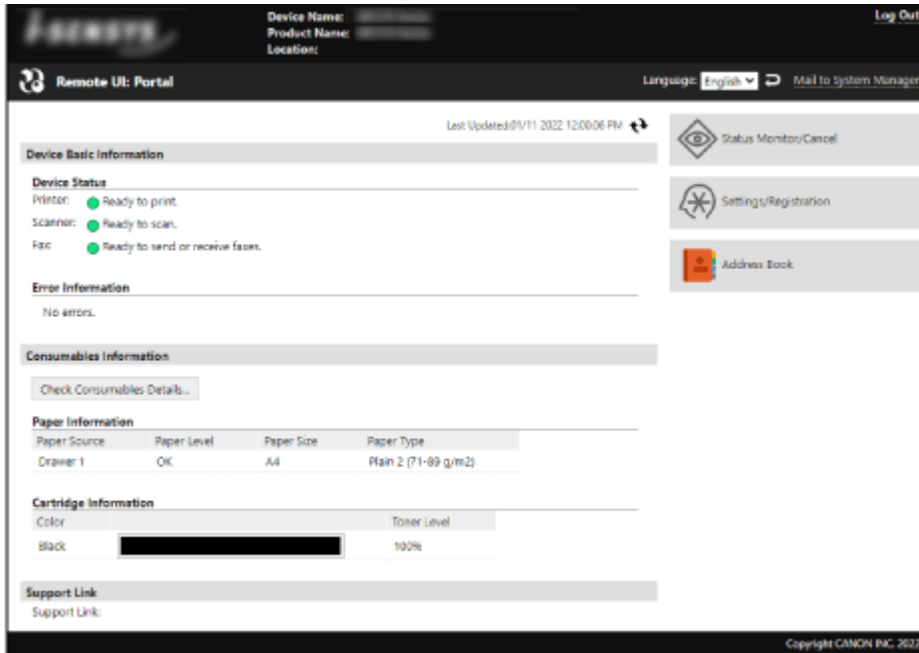

### [Device Name]

Displays the device name set in [Settings/Registration] ► [Device Management] ► [Device Information Settings].

### [Product Name]/[Product Name (Serial Number):]

Displays the product name of the machine.

Depending on the model, the serial number may also be displayed.

### [Location]

Displays the installation location set in [Settings/Registration] ► [Device Management] ► [Device Information Settings].

### [Login User]

Displays the information of the logged in user.

### [Log Out]

You are logged out of Remote UI, and the login screen is displayed.

### [Language]

You can change the display language of Remote UI.

\* The display languages of the computer and Remote UI must be the same. If the display languages are not the same, the entered information may not be displayed correctly, or you may not be able to reference a folder, server, or other specified destination.

### [Mail to System Manager]

Creates e-mail for the administrator indicated in [Settings/Registration] ► [User Management] ► [System Manager Information].

### [Last Updated]

Displays the date and time that the information displayed on the Portal page was last updated.

Click [ ↻ ] to the right of the date and time to update these.

### [Device Basic Information]

Displays the current status and error information of the machine.

When an error occurs, this displays a link to the error information screen.



**[Consumables Information]**

Displays the paper source information and remaining amount of ink in the toner cartridge. Click [Check Consumables Details] to display the toner cartridge name.

**[Support Link]**

Displays a link to support information for this machine that is set in [Settings/Registration] ▶ [License/Other] ▶ [Support Link].

**[Status Monitor/Cancel]**

Click this to display the [Status Monitor/Cancel] screen.

From here, you can check the status and logs of a function, operation status of the machine, and error information. ▶

**Checking Usage and Logs with Remote UI(P. 353)**

**[Settings/Registration]**

Click this to display the [Settings/Registration] screen.

If you logged in with System Manager Mode, you can change any settings and perform operations such as saving and importing data.

- The items that can be set in the [Settings/Registration] screen are nearly the same as those of the operation panel, but some items can only be set with either the operation panel or Remote UI. ▶ **Settings Menu Items(P. 376)**
- Depending on the item, you may have to restart the machine for the settings to be applied. If a restart is required, a message appears at the top of the screen.

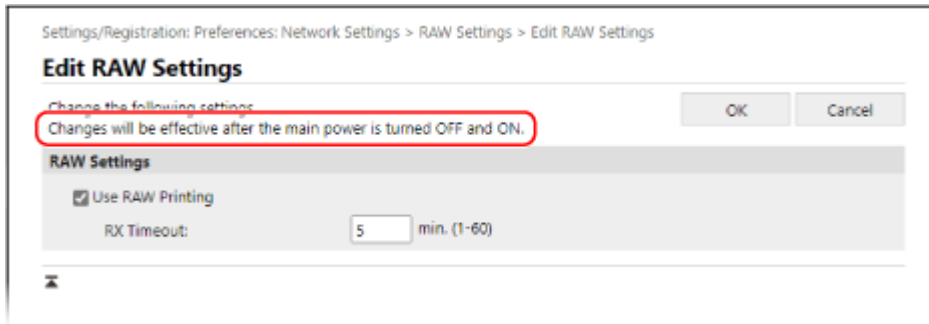

**[Address Book]**

Click this to display the [Address Book] screen.

If you logged in with System Manager Mode, you can register and edit destinations in the Address Book. ▶

**Registering Destinations to the Address Book (Remote UI) (Touch Panel Model)(P. 155)**

# Checking Usage and Logs with Remote UI

94WS-09A

From Status Monitor/Cancel in Remote UI, you can check the status and logs of a function, operation status of the machine, and error information.

- 1 Log in to Remote UI. ▶ Starting Remote UI(P. 349)
- 2 On the Portal page of Remote UI, click [Status Monitor/Cancel]. ▶ Portal Page of Remote UI(P. 351)
- 3 Select an item to view the status or log.

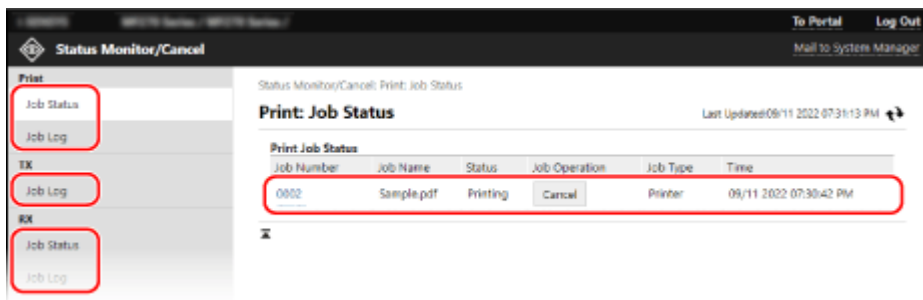

## [Print]

### [Job Status]

Displays the status (Printing or Waiting) of printed data.

If you logged in with Administrator Mode, this displays the print status for all jobs.

If you entered your user name in [User Name] when you logged in with General User Mode, only the print job status for that user is visible.

- Click [Job Number] for paused prints to display print details and view the user name and number of printed sheets.
- Click [Cancel] in [Job Operation] to delete the print data for jobs that are printing or waiting.

### [Job Log]

Displays the print job log.

## [TX]

### [Job Log]

Displays the TX job log for scan and fax jobs.

## [RX]

### [Job Status]

Displays the RX job status for fax.

With preview in Memory Lock enabled, you can view the fax details and print the fax when logged in with System Manager Mode. ▶ Saving Received Documents in the Machine (Memory Lock) (Touch Panel Model)(P. 331)

### [Job Log]

Displays the RX job log for fax.

## [Forward]

### [Forwarding Errors]

Displays information of the data being forwarded that ended with an error. With preview in Memory Lock enable, you can perform the following operations when logged in with System Manager Mode. **▶Saving Received Documents in the Machine (Memory Lock) (Touch Panel Model)(P. 331)**

- Click [Job Number] to view details and a preview of the data to be forwarded.
- Click [Delete] to delete the data to be forwarded.

\* If data cannot be forwarded but remains in the memory, it can be printed. **▶Checking Faxes that Failed to Be Forwarded(P. 237)**

#### **[Error Information]**

Displays information of errors occurring on the machine.

\* You can view the same information by clicking the link displayed in [Error Information] on the Portal page.

#### **[Consumables]**

Displays the paper size and type of each paper source and the toner cartridge name.

\* You can view the same information by clicking [Check Consumables Details] on the Portal page.

#### **[Device Features]**

Displays the specifications of the machine and the status of optional equipment.

#### **[Device Information]**

Displays information of the machine, such as the product name and serial number, as well as the firmware version and system manager information.

- [Device Name] and [Location] display the information set in [Settings/Registration] ▶ [Device Management] ▶ [Device Information Settings].
- [System Manager Information] displays the information set in [Settings/Registration] ▶ [User Management] ▶ [System Manager Information].

#### **[Check Counter]**

Displays the total number of pages copied and printed to date. **▶Checking the Number of Printed Pages (Check Counter)(P. 356)**

#### **[Cartridge Log]**

Displays a usage record in the toner cartridge.

#### **[Eco Information]**

Displays the average number of sheets output and average power consumption per month. You can change the settings of the following items in [Device Settings Status] to save paper and power.

- [N on 1 in Copy Settings]
- [2-Sided in Copy Settings]
- [Use Fax Preview in Memory Lock Settings] **▶Saving Received Documents in the Machine (Memory Lock) (Touch Panel Model)(P. 331)**

## **4 Log out from Remote UI after viewing the usage.**

## Monitoring the Usage

---

94WS-09C

You can use the operation panel of the machine to check the total number of copied and printed pages and print communication results, settings, and other reports and lists.

▶ **Checking the Number of Printed Pages (Check Counter)(P. 356)**

▶ **Printing and Viewing Reports and Lists(P. 358)**

### ■ See Also

You can also check the counter using Remote UI from a computer. In Remote UI, you can also check the status and logs of a function, operation status of the machine, and error information.

▶ **Checking Usage and Logs with Remote UI(P. 353)**

# Checking the Number of Printed Pages (Check Counter)

94WS-09E

You can display a counter showing the total number of pages copied and printed to date by black & white. The number of printed pages includes received faxes and printed reports and lists.

This section describes how to check the number of printed pages using the operation panel.

You can also check this information using Remote UI from a computer. [▶Checking Usage and Logs with Remote UI\(P. 353\)](#)

[▶Touch Panel Model\(P. 356\)](#)

[▶5 Lines LCD Model\(P. 356\)](#)

## Touch Panel Model

- 1 Press  on the operation panel. [▶Operation Panel\(P. 14\)](#)
- 2 Press [Device Status] ▶ [Check Counter].
- 3 Select the item you want to check.
- 4 Check the number of printed pages.

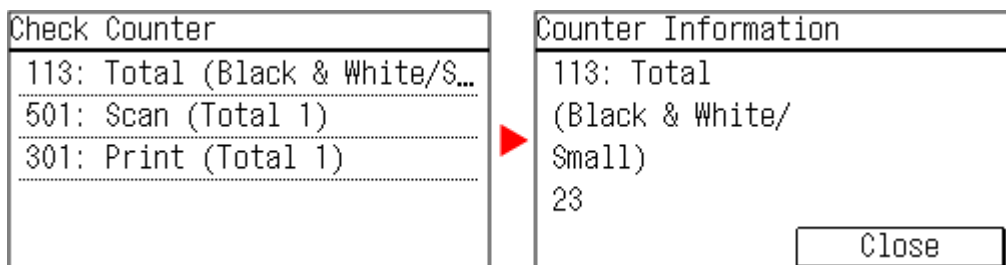

### [113: Total (Black & White/Small)]

Displays the total number of copied and printed pages in black & white.

### [501: Scan (Total 1)]

Displays the total number of scanned pages.

### [301: Print (Total 1)]

Displays the total number of printed pages.

## 5 Lines LCD Model

- 1 On the operation panel, press [Status Monitor] in the [Home] screen ▶ . [▶\[Home\] Screen\(P. 113\)](#)
  - ⇒ The [Status Monitor] screen is displayed.

**2** Press [Device Status] ► **OK** ► [Check Counter] ► **OK**.

⇒ The [Check Counter] screen is displayed.

**3** Select the item you want to check, and press **OK**.

**4** Check the number of printed pages.

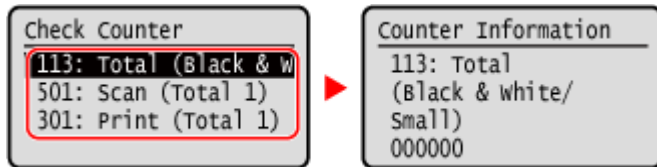

**[113: Total (Black & White/Small)]**

Displays the total number of copied and printed pages in black & white.

**[501: Scan (Total 1)]**

Displays the total number of scanned pages.

**[301: Print (Total 1)]**

Displays the total number of printed pages.

# Printing and Viewing Reports and Lists

94WS-09F

You can print and view reports and lists including machine usage, communication results, and settings.

▶ **Types of Reports and Lists(P. 358)**

▶ **Printing Reports and Lists(P. 359)**

## NOTE

### 2-Sided Printing of Reports and Lists

- Reports and lists are printed on paper on one side by default. You can change the setting to print on both sides. ▶ **Changing the Report and List Print Settings(P. 361)**

## Types of Reports and Lists

### Machine Usage Reports

You can print and view the following reports related to usage of the machine including power consumption and status of consumables:

- **Eco Report**  
Displays the number of printed pages and power consumption per month. You can see how to save paper and power based on this information.
- **Consumables Status Report**  
Displays the status of consumables installed in the machine.
- **Cartridge Log Report**  
Displays a log of toner cartridge usage.

### Communication Results Reports

You can print and view the following reports related to communication results including sending and receiving results and saving results.

With the exception of communication management reports, communication results reports cannot be printed manually. You must configure the settings in advance to print the reports automatically. ▶ **Changing the Report and List Print Settings(P. 361)**

- **Communication Management Report**  
Displays all communication results for faxes and scanned data.  
By default, this is printed automatically after every 40 communication events.  
You can also configure the settings to print sending and saving results and receiving results in a different format.
- **Fax TX Result Report**  
Displays the fax sending results.  
By default, this is printed automatically only when an error occurs.  
This can be set to print part of the original in the report.  
\* The results reports do not include sending results of faxes sent from a computer.
- **RX Result Report**  
Displays the receiving results for faxes.  
By default, this is not printed automatically.

### Settings Lists

You can print and view the following lists that summarize the registration information and settings of the machine:

- **Address Book List**  
Displays the destination information registered in the Address Book by [Coded Dial] and [Group].
- **User Data List**

Displays the serial number and other machine information as well as the settings that do not require administrator privileges.

- **System Manager Data List**

Displays the serial number and other machine information as well as the settings that require administrator privileges.

## Printing Reports and Lists

Print reports and lists using the operation panel. You cannot print these using Remote UI from a computer. Administrator privileges are required to print the following reports and lists:

- System Manager Data List

### ▶ Touch Panel Model(P. 359)

### ▶ 5 Lines LCD Model(P. 359)

#### ■ Touch Panel Model

**1** On the operation panel, press [Menu] in the [Home] screen. ▶ [Home] Screen(P. 113)

**2** Press [Output Rprt.] ▶ [Print List].

⇒ The [Print List] screen is displayed.

**3** Select the report or list to print.

⇒ A screen confirming the paper available for printing is displayed.

If the login screen appears, enter the System Manager ID and PIN, and then press [Log In]. ▶ **System Manager ID and PIN(P. 6)**

#### ■ To Print Address Book List

Select [Address Book List], and select the items to print.

**4** Check that printable paper is set in the machine, and press [OK] ▶ [Yes].

⇒ The report or list is printed.

#### ■ 5 Lines LCD Model

**1** On the operation panel, select [Menu] in the [Home] screen, and press **OK**. ▶ [Home] Screen(P. 113)

**2** Press [Output Reports] ▶ **OK** ▶ [Print List] ▶ **OK**.



### 3 Select the report or list to print.

⇒ A screen confirming the paper available for printing is displayed.

If the login screen appears, enter the System Manager ID and PIN, and then press [<Log In>] ► **OK** . ◀  
**System Manager ID and PIN(P. 6)**

### 4 Check that printable paper is set in the machine, select [Yes], and press **OK**.

⇒ The report or list is printed.

# Changing the Report and List Print Settings

94WS-09H

Reports and lists are printed on paper on one side by default. You can change the setting to print on both sides. You can also change the setting to automatically print communication results reports.

Use the operation panel to configure the settings. You cannot configure the settings using Remote UI from a computer.

▶ **Touch Panel Model(P. 361)**

▶ **5 Lines LCD Model(P. 362)**

## Touch Panel Model

**1** On the operation panel, press [Menu] in the [Home] screen. ▶ [Home] Screen(P. 113)

**2** Press [Output Rprt.] ▶ [Report Settings].

⇒ The [Report Settings] screen is displayed.

**3** Change the report and list print settings.

### ■ To Print Reports and Lists on Both Sides

**1** Press [Default Settings for Report Output].

⇒ The [Default Settings for Report Output] screen is displayed.

**2** Set [2-Sided Printing] to [On].

### ■ To Change the Communication Management Report Settings

**1** Press [Communication Management Report].

⇒ The [Comm. Mngt. Report] screen is displayed.

**2** Configure the report settings.

- To print automatically after every 40 communication events, set [Auto Print (40 Trans.)] to [On].
- To configure the settings to print sending and saving results and receiving results in a different format, set [Separate TX/RX] to [On].

### ■ To Change the Fax TX Result Report Settings

**1** Press [Fax TX Result Report].

⇒ The [Fax TX Result Report] screen is displayed.

**2** Select whether to print this report automatically.

- To print automatically after each send job, select [On]. To print automatically only when an error occurs, select [Only When Error Occurs].
- When [On] or [Only When Error Occurs] is selected, in [Include TX Image], select whether to print part of the original on the report.

### ■ To Change the RX Result Report Settings

- 1 Press [RX Result Report].  
 ⇒ The [RX Result Report] screen is displayed.
- 2 Select whether to print this report automatically.  
 To print automatically after each receive job, select [On]. To print automatically only when an error occurs, select [Only When Error Occurs].

## 5 Lines LCD Model

- 1 On the operation panel, select [Menu] in the [Home] screen, and press **OK**. **▶** [Home] Screen(P. 113)
- 2 Press [Output Reports] **▶** **OK** **▶** [Report Settings] **▶** **OK**.  
 ⇒ The [Report Settings] screen is displayed.
- 3 Select [Default Settings for Report Output] and press **OK**.  
 ⇒ The [Default Settings for Report Output] screen is displayed.
- 4 Press [2-sided Printing] **▶** **OK** **▶** [On] **▶** **OK**.

# Importing and Exporting the Address Book (Touch Panel Model)

94WS-09K

You can write the Address Book to files and save (export) them to a computer. You can also load an exported file and apply (import) the Address Book to the machine.

You can use the import and export functions to back up the Address Book in case of an accident.

In addition, an exported file can be imported to another device to enable sharing of the Address Book with another device without having to register destinations or configure settings.

▶ **Exporting the Address Book(P. 363)**

▶ **Importing the Address Book(P. 364)**

## IMPORTANT

### Do Not Turn OFF the Machine until the Import or Export Is Complete.

- It may take a few minutes until the process is completed. Turning OFF the machine during processing may cause data corruption or damage the machine.

### Do Not Operate the Machine during Import or Export.

- Before import or export, check that the machine is not printing or performing other operations.

## Exporting the Address Book

Select the items to export and write them to a file. When exporting the Address Book, select the file format that suits your needs.

Export the Address Book using Remote UI from a computer. You cannot use the operation panel to export it. Administrator privileges are required.

- 1 Log in to Remote UI in System Manager Mode. ▶ Starting Remote UI(P. 349)**
- 2 On the Portal page of Remote UI, click [Settings/Registration]. ▶ Portal Page of Remote UI(P. 351)**
- 3 Click [Data Management] ▶ [Export].**
  - ⇒ The [Export] screen is displayed.
- 4 Click [Start Exporting] to save the exported data as a file to a computer.**
- 5 Log out from Remote UI.**

## Importing the Address Book

Specify the exported file and select the items to be imported.

### File formats for import

- Device configuration information file (\*.dcm)
- Canon Address Book file (\*.abk)

Import the Address Book using Remote UI from a computer. You cannot use the operation panel to import it. Administrator privileges are required. Depending on the items to be imported, the machine restarts automatically.

- 1 Log in to Remote UI in System Manager Mode. ▶ Starting Remote UI(P. 349)**
- 2 On the Portal page of Remote UI, click [Settings/Registration]. ▶ Portal Page of Remote UI(P. 351)**
- 3 Click [Data Management] ▶ [Import].**
  - ⇒ The [Import] screen is displayed.
- 4 Click [Browse] in [File Path], and specify the file to be imported.**
- 5 Click [Start Importing] ▶ [OK].**
  - ⇒ The selected file is imported to the machine.
- 6 When the screen indicating that importing has completed appears, click [OK].**
- 7 Log out from Remote UI.**

# Updating the Firmware (Touch Panel Model)

94WS-09L

When functions are added or the software version is upgraded, the firmware of the machine is updated. Check the version of the firmware, and update the firmware via the Internet or a computer according to the usage environment of the machine.

✓ : Can be updated    — : Cannot be updated

Usage environment of the machine	Connection via Internet	Connection via computer
Wired LAN connection	✓	✓
Wireless LAN connection	✓	—
USB connection	—	✓
Use IPv6	—	—

\* You cannot update the firmware in an IPv6 Environment. Connect the machine to a computer via USB, and update from the computer.

- ▶ **Checking the Firmware Version(P. 365)**
- ▶ **Updating the Firmware via the Internet(P. 366)**
- ▶ **Updating the Firmware via a Computer(P. 366)**

## Checking the Firmware Version

Check the current version of the firmware before updating it, and then check the version after updating to see if the update was performed correctly.

This section describes how to check the firmware version using the operation panel.

You can also use Remote UI from a computer to check the firmware version. ▶ **Managing the Machine from a Computer (Remote UI)(P. 348)**

Administrator privileges are required.

**1** On the operation panel, press [Menu] in the [Home] screen. ▶ **[Home] Screen(P. 113)**

**2** Press [Management Settings] ▶ [Remote UI Settings/Update Firmware] ▶ [Update Firmware].

⇒ The [Update Firmware] screen is displayed.

If the login screen appears, enter the System Manager ID and PIN, and then click [Log In]. ▶ **System Manager ID and PIN(P. 6)**

**3** Select [Version Information].

⇒ Displays the current version of the firmware.

## Updating the Firmware via the Internet

Use the operation panel to update the firmware via the Internet. You cannot update it using Remote UI from a computer. Administrator privileges are required. When the firmware has been updated, the machine restarts automatically.

### Required Preparations

- Connect the machine to the Internet. ▶ **Setting Up the Network(P. 49)**

**1 On the operation panel, select [Menu] in the [Home] screen. ▶ [Home] Screen(P. 113)**

**2 Press [Management Settings] ▶ [Remote UI Settings/Update Firmware] ▶ [Update Firmware].**

⇒ The [Update Firmware] screen is displayed.

If the login screen appears, enter the System Manager ID and PIN, and then click [Log In]. ▶ **System Manager ID and PIN(P. 6)**

**3 Press [Via Internet] ▶  ▶ [Yes].**

⇒ The firmware update confirmation screen is displayed.

**4 In the licensing screen, press [Accept].**

**5 Press [OK].**

⇒ Downloading of the firmware starts.

When the download is complete, the machine restarts automatically, and the firmware is updated.

### **IMPORTANT**

- Do not turn OFF the machine until the restart is complete.

## Updating the Firmware via a Computer

Update the firmware from a computer connected to the machine via wired LAN or USB.

### Required Preparations

- Download the latest firmware from the Canon website for your country/region to the computer performing the update.  
<https://global.canon/en/support/>

## ■ How to Update from a Computer

See the "User Support Tool Operation Guide" included with the firmware.

## ■ To Put the Machine into Update Waiting State (Download Mode)

Use the following procedure.

Use the operation panel to perform this operation. You cannot perform this operation using Remote UI from a computer.

Administrator privileges are required.

**1 On the operation panel, press [Menu] in the [Home] screen. ▶[Home] Screen(P. 113)**

**2 Press [Management Settings] ▶ [Remote UI Settings/Update Firmware] ▶ [Update Firmware].**

⇒ The [Update Firmware] screen is displayed.

If the login screen appears, enter the System Manager ID and PIN, and then click [Log In]. ▶**System Manager ID and PIN(P. 6)**

**3 Press [Via PC] ▶ [Yes].**

⇒ Switches the machine to download mode and puts it into update waiting state.



## Updating the Firmware (5 Lines LCD Model)

94WS-0J5

When functions are added or the software version is upgraded, the firmware of the machine is updated. Check the version of the firmware, and update the firmware via the Internet or a computer according to the usage environment of the machine.

✓ : Can be updated    — : Cannot be updated

Usage environment of the machine	Connection via Internet	Connection via computer
Wired LAN connection	✓	✓
Wireless LAN connection	✓	—
USB connection	—	✓
Use IPv6	—	—

\* You cannot update the firmware in an IPv6 Environment. Connect the machine to a computer via USB, and update from the computer.

- ▶ **Checking the Firmware Version(P. 368)**
- ▶ **Updating the Firmware via the Internet(P. 369)**
- ▶ **Updating the Firmware via a Computer(P. 369)**

### Checking the Firmware Version

Check the current version of the firmware before updating it, and then check the version after updating to see if the update was performed correctly.

This section describes how to check the firmware version using the operation panel.

You can also use Remote UI from a computer to check the firmware version. ▶ **Managing the Machine from a Computer (Remote UI)(P. 348)**

Administrator privileges are required.

- 1** On the operation panel, select [Menu] in the [Home] screen, and press **OK**. ▶ **[Home] Screen(P. 113)**
- 2** Press [Management Settings] ▶ **OK** ▶ [Remote UI Settings/Update Firmware] ▶ **OK** ▶ [Update Firmware] ▶ **OK**.
  - ⇒ The [Update Firmware] screen is displayed.

If the login screen appears, enter the System Manager ID and PIN, and then press [<Log In>] ▶ **OK**. ▶ **System Manager ID and PIN(P. 6)**
- 3** Select [Version Information], and press **OK**.

⇒ Displays the current version of the firmware.

## Updating the Firmware via the Internet

Use the operation panel to update the firmware via the Internet. You cannot update it using Remote UI from a computer. Administrator privileges are required. When the firmware has been updated, the machine restarts automatically.

### Required Preparations

- Connect the machine to the Internet. ▶ **Setting Up the Network(P. 49)**

**1** On the operation panel, select [Menu] in the [Home] screen, and press **OK**. ▶ **[Home] Screen(P. 113)**

**2** Press [Management Settings] ▶ **OK** ▶ [Remote UI Settings/Update Firmware] ▶ **OK** ▶ [Update Firmware] ▶ **OK**.

⇒ The [Update Firmware] screen is displayed.

If the login screen appears, enter the System Manager ID and PIN, and then press [<Log In>] ▶ **OK**. ▶ **System Manager ID and PIN(P. 6)**

**3** Press [Via Internet] ▶ **OK** ▶ [Yes] ▶ **OK**.

⇒ The firmware update confirmation screen is displayed.

**4** In the licensing screen, press **OK**.

**5** Press **OK**.

⇒ Downloading of the firmware starts.

### IMPORTANT

- Do not turn the machine OFF while it is restarting or during the firmware update. Doing so may cause the update to fail.
- Failed updating may result in an error message appearing during startup and the machine being unusable. In this event, use the dedicated recovery firmware to redo the update via a computer. ▶ **Updating the Firmware via a Computer(P. 369)**  
\* Download the dedicated recovery firmware from the Canon website for your country/region.  
<https://global.canon/en/support>

## Updating the Firmware via a Computer

Update the firmware from a computer connected to the machine via wired LAN or USB.

### Required Preparations

- Download the latest firmware from the Canon website for your country/region to the computer performing the update.  
<https://global.canon/en/support/>

## ■ How to Update from a Computer



See the "User Support Tool Operation Guide" included with the firmware.

## ■ To Put the Machine into Update Waiting State (Download Mode)

Use the following procedure.



Use the operation panel to perform this operation. You cannot perform this operation using Remote UI from a computer.

Administrator privileges are required.

**1 On the operation panel, select [Menu] in the [Home] screen, and press .  [Home] Screen(P. 113)**

**2 Press [Management Settings]    [Remote UI Settings/Update Firmware]    [Update Firmware]  .**

⇒ The [Update Firmware] screen is displayed.

If the login screen appears, enter the System Manager ID and PIN, and then press [**<Log In>**]  .   
**System Manager ID and PIN(P. 6)**

**3 Press [Via PC]    [Yes]  .**

⇒ Switches the machine to download mode and puts it into update waiting state.

# Initializing the Settings and Data

94WS-09R

You can initialize the settings and registered data to reset the machine to the factory settings. You can initialize specified settings and data only or initialize all settings and data.

## Initializing Specific Settings and Data

You can initialize the following items separately:

- Settings menu: Initializes the settings of [Menu] in the [Home] screen.
- Key and Certificate: Initializes the settings of the key and certificate as well as CA certificate, and clears everything except the pre-installed key and certificate.
- Address Book: Clears the destinations registered in the Address Book.

### ▶ Initializing Specific Settings and Data(P. 371)

## Initializing All Settings and Data

You can reset all settings to the factory settings, and clear all stored data including logs. Initialization is performed to prevent access to confidential information and unauthorized use such as when replacing or disposing of the machine.

### ▶ Initializing All Settings and Data(P. 372)

## Initializing Specific Settings and Data

This section describes how to initialize settings and data using Remote UI from a computer.

On the operation panel, select [Menu] in the [Home] screen, and then perform initialization from [Preferences] or [Management Settings]. ▶[Initialize Network Settings](P. 390) / ▶[Data Management](P. 457)

Administrator privileges are required. Depending on the item to be initialized, you may have to restart the machine.

### 1 Log in to Remote UI in System Manager Mode. ▶Starting Remote UI(P. 349)

### 2 On the Portal page of Remote UI, click [Settings/Registration]. ▶Portal Page of Remote UI(P. 351)

### 3 Click [Data Management].

⇒ The [Data Management] screen is displayed.

### 4 Select the item to initialize.

#### ■ Initializing the Settings Menu

Click [Initialize Menu], and select the setting to be initialized from [Menu to Initialize].

#### ■ When Initializing a Key and Certificate

Click [Initialize Key and Certificate].

#### ■ When Initializing the Address Book

Click [Initialize Address Book].

If the [Enter PIN] screen appears, enter the Address Book PIN, and then click [OK].

### 5 Click [Initialize] ▶ [OK].

⇒ The specified item is initialized.

## 6 Log out from Remote UI.

### ■ When the Settings Menu Is Initialized

When any of the following is initialized, restart the machine to apply the initialized settings. ▶ **Restarting the Machine(P. 106)**

- [Preferences]
- [Function Settings]
- [Management Settings]
- [Network Settings]

## NOTE

### When Initializing a Key and Certificate

- Functions using a key and certificate such as TLS are disabled. To use these functions again, you must set the key and certificate, and then enable the function.

### When [Management Settings] of the Settings Menu Is Initialized

- This also initializes the Remote UI Access PIN. To use Remote UI, you must set the Remote UI Access PIN again. ▶ **Setting the PIN to Use for Remote UI(P. 337)**

## Initializing All Settings and Data

Use the operation panel to initialize all settings and data. You cannot initialize these using Remote UI from a computer. Administrator privileges are required. When these are initialized, the machine restarts automatically.

## ! IMPORTANT

- Before initialization, check that there is no data being processed or waiting to be processed. This data is deleted when the initialization is performed.

▶ **Touch Panel Model(P. 372)**

▶ **5 Lines LCD Model(P. 373)**

### ■ Touch Panel Model

**1** On the operation panel, press [Menu] in the [Home] screen. ▶ **[Home] Screen(P. 113)**

**2** Press [Management Settings] ▶ [Initialize All Data/Settings].

⇒ The initialization confirmation screen is displayed.



If the login screen appears, enter the System Manager ID and PIN, and then press [Log In]. ▶ **System Manager ID and PIN(P. 6)**

**3 Press [Next] ▶ [Yes].**

⇒ All settings and data are initialized.



When initialization is complete, the machine restarts automatically.

■ **5 Lines LCD Model**

**1 On the operation panel, select [Menu] in the [Home] screen, and press .  [Home] Screen(P. 113)**

**2 Press [Management Settings] ▶  ▶ [Initialize All Data/Settings] ▶ .**

⇒ The initialization confirmation screen is displayed.

If the login screen appears, enter the System Manager ID and PIN, and then press [**<Log In>**] ▶ .   
**System Manager ID and PIN(P. 6)**

**3 Press  ▶ [Yes] ▶ .**

⇒ All settings and data are initialized.

When initialization is complete, the machine restarts automatically.

# Settings Menu Items

<b>Settings Menu Items</b> .....	376
<b>[Preferences]</b> .....	377
[Display Settings] .....	379
[Timer/Energy Settings] .....	383
[Network] .....	386
[Wireless LAN Settings] .....	391
[TCP/IP Settings] .....	393
[External Interface] .....	400
[Accessibility] .....	401
[Volume Settings] (Touch Panel Model) .....	403
<b>[Adjustment/Maintenance]</b> .....	406
[Adjust Image Quality] .....	407
[Special Processing] .....	408
[Maintenance] .....	413
<b>[Function Settings]</b> .....	414
[Common] .....	415
[Paper Feed Settings] .....	416
[Print Settings] .....	417
[Scan Settings] .....	418
[Generate File] .....	419
[Copy] .....	420
[Printer] .....	422
[Printer Settings] .....	423
[PDL Selection (Plug and Play)] (Touch Panel Model) .....	429
[Send] .....	430
[Common Settings] (Touch Panel Model) .....	431
[Scan and Send Settings] .....	433
[Fax Settings] (Touch Panel Model) .....	435
[Receive/Forward] (Touch Panel Model) .....	441
[Common Settings] (Touch Panel Model) .....	442
[Fax Settings] (Touch Panel Model) .....	444
<b>[Set Destination] (Touch Panel Model)</b> .....	448
<b>[Management Settings]</b> .....	449
[User Management] .....	451
[Device Management] .....	452

## Settings Menu Items

[Remote UI Settings/Update Firmware] .....	455
[Remote UI Settings] .....	456
[Data Management] .....	457
[Security Settings] .....	458
[Authentication/Password Settings] .....	459



# Settings Menu Items

---

94WS-09S

This section describes the items available in the settings menu displayed when you press [Menu] in the [Home] screen on the operation panel.

From the settings menu, you can run functions and modify the settings according to the machine's operating environment or its usage.

Administrator privileges are required to view or change some settings. Note also that the machine may need to be restarted for changed settings to take effect.

- ▶ **[Preferences](P. 377)**
- ▶ **[Adjustment/Maintenance](P. 406)**
- ▶ **[Function Settings](P. 414)**
- ▶ **[Set Destination] (Touch Panel Model)(P. 448)**
- ▶ **[Management Settings](P. 449)**

## ■ See Also

### **If a Login Screen Appears**

If a System Manager ID has been set, a login screen may appear when certain items are selected. Once you enter the required information and the login is authenticated, you can view or change the settings.

- ▶ **Logging In to the Machine(P. 127)**

### **If the Machine Must be Restarted**

After changing the settings, restart the machine.

- ▶ **Restarting the Machine(P. 106)**

### **Settings Not Included in the Menus**

The Paper Settings items appear when you press [Paper Settings] in the [Home] screen.

- ▶ **Specifying the Paper Size and Type(P. 139)**

### **Configuring Settings from Remote UI**

The settings menu items can also be specified from a computer using Remote UI. In Remote UI, specify the settings from [Settings/Registration] in the Portal page.

The items that can be specified in [Settings/Registration] in Remote UI are almost identical to those in the operation panel settings menu, but there are also items that can be specified only from the operation panel or only from Remote UI. Note also that some of the item names differ in Remote UI.

- ▶ **Managing the Machine from a Computer (Remote UI)(P. 348)**

### **Checking the Settings**

You can check a list of the current settings by printing them out.

- ▶ **Printing and Viewing Reports and Lists(P. 358)**

## [Preferences]

---

These are settings used to configure features such as the operation panel screen displays and the network settings according to the environment in which the machine is used.

\* Values in bold red text indicate the default setting for each item.

- ▶ **[Display Settings](P. 377)**
- ▶ **[Timer/Energy Settings](P. 377)**
- ▶ **[Network](P. 377)**
- ▶ **[External Interface](P. 377)**
- ▶ **[Accessibility](P. 377)**
- ▶ **[Volume Settings] (Touch Panel Model)(P. 378)**

### [Display Settings]

[Menu] ▶ [Preferences]

Configure the operation panel screen displays.

- ▶ **[Display Settings](P. 379)**

### [Timer/Energy Settings]

[Menu] ▶ [Preferences]

Set the date and time and specify the Energy Saver settings.

- ▶ **[Timer/Energy Settings](P. 383)**

### [Network]

[Menu] ▶ [Preferences]

Configure the network environment for the machine.

- ▶ **[Network](P. 386)**

### [External Interface]

[Menu] ▶ [Preferences]

Configure the USB connection.

- ▶ **[External Interface](P. 400)**

### [Accessibility]

[Menu] ▶ [Preferences]

Configure operation panel screen features such as screen color inversion and message display time to make the screen easier to see.

- ▶ **[Accessibility](P. 401)**

## [Volume Settings] (Touch Panel Model)

[Menu] ▶ [Preferences]

Set whether sounds are emitted.

🔴 **[Volume Settings] (Touch Panel Model)(P. 403)**

## [Display Settings]

94WS-09W

Configure the operation panel screen displays.

\* Values in bold red text are the default settings for each item.

▶ [Default Screen after Startup/Restoration]

(P. 379)

▶ [Button Display Order on Home Screen](P. 379)

▶ [Language](P. 380)

▶ [Remote UI Language](P. 380)

▶ [Millimeter/Inch Entry Switch](P. 381)

▶ [Displ. Timing for Cartridge Prep. Notif.]

(P. 381)

▶ [Show Warnings](P. 381)

▶ [Action When Warning](P. 382)

▶ [Display IP Address](P. 382)

▶ [Notify to Clean Original Scanning Area]  
(P. 382)

### [Default Screen after Startup/Restoration]

[Menu] ▶ [Preferences] ▶ [Display Settings]

Specify the screen displayed after the start screen appears when the machine is turned ON and immediately after an Auto Reset.

Setting this for the [Status Monitor] enables you to also specify the screen displayed immediately after the [Status Monitor] screen is closed.

[Home]
[Copy]
[Fax]* <sup>1</sup>
[Scan]
[Status Monitor]
[Home]
[Copy]
[Fax]* <sup>1</sup>
[Scan]

\*<sup>1</sup> May not be displayed depending on the model, the installed options, and other settings.

### [Button Display Order on Home Screen]

[Menu] ▶ [Preferences] ▶ [Display Settings]

Rearrange the buttons or change the display order of the items so that you can run frequently used functions more quickly from the [Home] screen of the operation panel. ▶ **Customizing the [Home] Screen(P. 125)**

#### Touch Panel Model

[Set Display Order]
[Insert and Delete Blank]

## [Language]

[Menu] ► [Preferences] ► [Display Settings]

Change the language shown on the operation panel and used in printed reports.

\* Depending on your country or region, the [Language] setting may not be available, or its content or default setting may be different.

[Català]
[Čeština]
[Dansk]
[Deutsch]
[Eesti]
<b>[English]</b>
[Español]
[Euskara]
[Français]
[Hrvatski]
[Italiano]
[Latviešu]
[Lietuvių]
[Magyar]
[Nederlands]
[Norsk]
[Polski]
[Português]
[Română]
[Slovenčina]
[Slovenščina]
[suomi]
[Svenska]
[Türkçe]
[Ελληνικά]
[Български]
[Русский]
[Українська]
[العربية]
[日本語]
[中文(繁體)]
[中文(简体)]
[한국어]

## [Remote UI Language]

[Menu] ► [Preferences] ► [Display Settings]

Change the language shown on Remote UI screens.

\* Depending on your country or region, the [Remote UI Language] setting may not be available, or its content or default setting may be different.

[English]  
 [Japanese]  
 [French]  
 [Spanish]  
 [German]  
 [Italian]  
 [Dutch]  
 [Finnish]  
 [Portuguese]  
 [Norwegian]  
 [Swedish]  
 [Danish]  
 [Czech]  
 [Hungarian]  
 [Russian]  
 [Turkish]  
 [Polish]  
 [Chinese (Simplified)]  
 [Chinese (Traditional)]  
 [Korean]

## [Millimeter/Inch Entry Switch]

[Menu] ► [Preferences] ► [Display Settings]

Change the units shown on the screen for entering length and width.

[Millimeter]  
 [Inch]

## [Displ. Timing for Cartridge Prep. Notif.]

[Menu] ► [Preferences] ► [Display Settings]

When the toner in a toner cartridge runs low, a message appears notifying you to prepare a new toner cartridge. To manually specify when this message appears (the toner level in a cartridge), specify the timing in [Custom]. When [Auto] is enabled, the machine automatically decides when to display the message.

[Auto]  
 [Custom]  
 20 to 99 (%) (Touch Panel Model)  
 2 to 20 to 99 (%) (5 Lines LCD Model)

## [Show Warnings]

[Menu] ► [Preferences] ► [Display Settings]

Specify whether a notification message is displayed when a toner cartridge is low on toner.

\* If the machine is configured to stop printing when a toner cartridge is low on toner, this cannot be set to [Off]. ►  
**[Action When Warning](P. 382)**

\* If the machine is configured not to print incoming faxes when a toner cartridge is low on toner, the message appears even when this is set to [Off]. ►**[Continue Print. When Amount in Cart. Low](P. 442)**

[Low Cartridge Level]  
[Off]  
[On]

## [Action When Warning]

[Menu] ▶ [Preferences] ▶ [Display Settings]

Specify whether to continue printing when a toner cartridge is low on toner.

If this is set to [Stop Printing], a notification message appears when the toner cartridge runs low on toner. ▶[**Show Warnings**](P. 381)

[Low Cartridge Level]  
[Continue Printing]  
[Stop Printing]

## [Display IP Address]

[Menu] ▶ [Preferences] ▶ [Display Settings]

Specify whether to display the machine's IPv4 address in the [Status Monitor] screen. ▶[**Status Monitor Screen**](P. 116)

[Off]  
[On]

## [Notify to Clean Original Scanning Area] \*1

[Menu] ▶ [Preferences] ▶ [Display Settings]

Specify whether a message is displayed to notify you if soiling is detected during feeder use.

[Off]  
[On]

\*1 May not be displayed depending on the model, the installed options, and other settings.

## [Timer/Energy Settings]

94WS-09X

Set the date and time and specify the Energy Saver settings.

\* Values in bold red text are the default settings for each item.

▶ [Current Date/Time Settings](P. 383)

▶ [Date/Time Settings](P. 383)

▶ [Date Format](P. 384)

▶ [Time Format](P. 384)

▶ [Auto Reset Time](P. 384)

▶ [Function After Auto Reset](P. 384)

▶ [Auto Shutdown Time](P. 385)

▶ [Auto Sleep Time](P. 385)

### [Current Date/Time Settings]

[Menu] ▶ [Preferences] ▶ [Timer/Energy Settings]

Set the date and time for the machine. The date and time set here are used as a reference for the functions that use date and time information. ▶ **Setting the Date and Time(P. 347)**

Before configuring this setting, check that the correct time zone is selected. ▶ **[Date/Time Settings](P. 383)**

\* The current date and time cannot be changed for one hour after Daylight Saving Time is set.

### [Date/Time Settings]

[Menu] ▶ [Preferences] ▶ [Timer/Energy Settings]

Set the time zone (UTC\*<sup>1</sup>) and Daylight Saving Time according to the region where the machine is installed.

\*<sup>1</sup> The UTC (Coordinated Universal Time) is a coordinated universal time that is standard for all parts of the world. Internet-based communication relies on the UTC being set correctly.

\* Depending on your country or region, the [Date/Time Settings] setting may not be displayed, or its content or default setting may be different.

\* When you change the time zone, the current time setting is automatically changed accordingly. ▶ **[Current Date/Time Settings](P. 383)** .

\* If daylight saving time is enabled, specify the dates from which and to which daylight saving time is in effect.

[Time Zone]

[(UTC-12:00) International Date Line West] to **[(UTC) Coordinated Universal Time]** to [(UTC+14:00) Kiritimati Island]

[Daylight Saving Time Settings]

[Off]

**[On]**

[Start]: Month, Week, Day

[End]: Month, Week, Day



## [Date Format]

[Menu] ▶ [Preferences] ▶ [Timer/Energy Settings]

Set the order in which the year, month, and day are displayed.

\* Depending on your country or region, the [Date Format] setting may not be available, or its content or default setting may be different.

[YYYY MM/DD]  
[MM/DD/YYYY]  
[DD/MM YYYY]

## [Time Format]

[Menu] ▶ [Preferences] ▶ [Timer/Energy Settings]

Set 12 Hour or 24 Hour as the format for displayed time.

[12 Hour (AM/PM)]  
[24 Hour]

## [Auto Reset Time]

[Menu] ▶ [Preferences] ▶ [Timer/Energy Settings]

If the operation panel is not used for a set period, a function called "Auto Reset Time" automatically restores the default settings. This setting specifies whether Auto Reset is invoked. If you enable Auto Reset, you can then set the time after which it is triggered.

\* You can also change the screen that is displayed after an Auto Reset. ▶[Function After Auto Reset](P. 384)

0 (Off)  
1 to 2 to 9 (min.)

## NOTE

### Situations Where Auto Reset is Not Triggered

- When the Error lamp on the operation panel is flashing ▶**Operation Panel(P. 14)**
- When the [Menu] screen or an error message<sup>\*1</sup> is displayed on the operation panel
- When processing of some sort (such as printing or sending and receiving faxes) is in progress

\*1 Auto Reset is performed for some messages.

## [Function After Auto Reset]

[Menu] ▶ [Preferences] ▶ [Timer/Energy Settings]

Set the screen displayed after an Auto Reset.

- To view the specified screen, specify the screen in [Default Function]. Specify the displayed screen in [Default Screen after Startup/Restoration]. ▶**[Default Screen after Startup/Restoration](P. 379)**

- To display the screen for the function being used before the Auto Reset, specify the screen in [Selected Function].

[Default Function]  
[Selected Function]

## [Auto Shutdown Time]

[Menu] ▶ [Preferences] ▶ [Timer/Energy Settings]

Set a timer to automatically shut down the machine after a specified period of idle time has elapsed since the machine entered the sleep mode.

When the [Auto Shutdown Time] setting is enabled, the machine may automatically shut down even if you are operating the machine from Remote UI. A malfunction may occur, particularly if the machine shuts down while data is being imported. When you import data using Remote UI, set [Auto Shutdown Time] to [Off] in advance.

\* If any settings of the [Timer Settings] are changed from Remote UI while the machine is in the sleep mode, the timer for the [Auto Shutdown Time] setting is reset to the beginning. The machine automatically shuts down after a specified period of idle time has elapsed since the timer was reset.

\* Depending on your country or region, the [Auto Shutdown Time] setting may not be available, or its content or default setting may be different.

0 (Off)  
1 to 4 to 8 (hr.)

## [Auto Sleep Time]

[Menu] ▶ [Preferences] ▶ [Timer/Energy Settings]

Set the time after which the machine automatically goes into sleep mode. ▶ **Reducing Power Consumption (Sleep Mode)(P. 107)**

\* Use of the default settings is recommended to achieve the most effective power savings.

1 to 60 (min.)

## [Network]

94WS-09Y

Specify the settings for the machine's network environment.

\* Values in bold red text are the default settings for each item.

- ▶ [Select Wired/Wireless LAN](P. 386)
- ▶ [Wireless LAN Settings](P. 386)
- ▶ [Direct Connection Settings](P. 386)
- ▶ [Easy Connection via PC](P. 387)
- ▶ [TCP/IP Settings](P. 387)
- ▶ [SNMP Settings](P. 387)
- ▶ [Dedicated Port Settings](P. 388)
- ▶ [Dedicated Port Authentication Method](P. 388)
- ▶ [Waiting Time for Connection at Startup] (P. 388)
- ▶ [Ethernet Driver Settings](P. 388)
- ▶ [IEEE 802.1X Settings](P. 389)
- ▶ [Firewall Settings](P. 389)
- ▶ [Web Service Setup](P. 390)
- ▶ [Web Service Inquiry](P. 390)
- ▶ [RMT-SW](P. 390)
- ▶ [Initialize Network Settings](P. 390)

### [Select Wired/Wireless LAN]

[Menu] ▶ [Preferences] ▶ [Network]

Set whether to connect the machine to the network using a wired or wireless LAN. ▶ **Selecting Wired or Wireless LAN(P. 51)**

\* If you are switching from a wired LAN to a wireless LAN, you can make the change within the procedure for configuring the wireless LAN.

<p>[Wired LAN]</p> <p>[Wireless LAN]</p>
--

### [Wireless LAN Settings]

[Menu] ▶ [Preferences] ▶ [Network]

Specify the settings for connecting the machine to a wireless LAN and to save energy while the machine is connected to a wireless LAN.

▶ [Wireless LAN Settings](P. 391)

### [Direct Connection Settings]

[Menu] ▶ [Preferences] ▶ [Network]

Specify the settings for using a direct connection and for the connection function. ▶ **Enabling the Direct Connection Function(P. 275)**

<p>[Use Direct Connection]</p> <p>[Off]</p> <p>[On]</p> <p>[Time Until Direct Connection Termination]</p> <p>0 (Off)</p> <p>1 to 60 (min.)</p> <p>[Access Point Mode Settings]</p>
--

[Use Custom SSID]
[Off]
[On]
[SSID (1-20 Characters)]
[Use Custom Network Key]
[Off]
[On]
[Network Key (10 Char.)]
[Keep Enabled If SSID/Ntwk Key Spcfd]* <sup>1</sup>
[Off]
[On]
[IP Address Settings for Direct Conn.]
<b>192.168.22.1</b>

\*<sup>1</sup> May not be displayed depending on the model, the installed options, and other settings.

## [Easy Connection via PC]

[Menu] ► [Preferences] ► [Network]

Start cableless setup mode.

To configure the network settings using the Canon Laser NW Device Setup Utility, select cableless setup mode.

\* You can download the Canon Laser NW Device Setup Utility from the Canon website for your country/region.  
<https://global.canon/en/support/>

## [TCP/IP Settings]

[Menu] ► [Preferences] ► [Network]

Specify the settings for using the machine on a TCP/IP network.

▶ **[TCP/IP Settings](P. 393)**

## [SNMP Settings]

[Menu] ► [Preferences] ► [Network]

Specify the settings for setting up, monitoring, and controlling the machine using SNMP management software. ▶  
**Configuring SNMP(P. 83)**

To ensure compliance with the protocol's advanced specifications (RFC2790) when the machine's status is being monitored, set [Format Host Resources MIB to RFC2790] to [On].

[SNMPv1 Settings]
[Off]
[On]
[SNMPv3 Settings]
[Off]
[On]
[Acquire Printer Mngt. Info. from Host]

[Off]  
 [On]  
 [Format Host Resources MIB to RFC2790]  
 [Off]  
 [On]

## [Dedicated Port Settings]

[Menu] ▶ [Preferences] ▶ [Network]

Specify whether to use a dedicated port.

Use a dedicated port for tasks such as printing from a computer, scanning using the MF Scan Utility, and configuring or browsing the machine's settings.

[Off]  
 [On]

## [Dedicated Port Authentication Method]

[Menu] ▶ [Preferences] ▶ [Network]

Set the authentication method when using a dedicated port.

If you specify [Mode 2], communication via the dedicated port will be limited to secure authentication methods only. This may mean that you cannot connect to the machine from device management software, drivers or other software.

[Mode 1]  
 [Mode 2]

## [Waiting Time for Connection at Startup]

[Menu] ▶ [Preferences] ▶ [Network]

Set the waiting time until a connection is established when the machine starts up.

If the machine is connected via a device such as a switching hub, you may not be able to connect to the network even when the setting on the machine is correct. If so, set the waiting time and reconnect.

0 to 300 (sec.)

## [Ethernet Driver Settings]

[Menu] ▶ [Preferences] ▶ [Network]

Set the Ethernet communication method. [▶ Manually Configuring the Ethernet Settings\(P. 77\)](#)

This also allows you to check the MAC address on a wired LAN. [▶ Viewing the MAC Address of the Wired LAN\(P. 90\)](#)

[Auto Detect]  
 [Off]  
 [Communication Mode]  
 [Half Duplex]  
 [Full Duplex]  
 [Ethernet Type]  
 [10BASE-T]

[100BASE-TX] <b>[On]</b> [MAC Address]
--

## [IEEE 802.1X Settings]

[Menu] ► [Preferences] ► [Network]

Specify whether to use IEEE 802.1X.

Use Remote UI from a computer to set the IEEE 802.1X authentication method. ► **Using IEEE 802.1X(P. 312)**

\* [IEEE 802.1X Settings] may not be displayed depending on the model, the installed options, and other settings.

<b>[Off]</b> [On]
----------------------

## [Firewall Settings]

[Menu] ► [Preferences] ► [Network]

Specify whether to enable an IP address filter and MAC address filter.

Use Remote UI from a computer to set the default policy for filtering and the exception addresses. ► **Setting the Firewall(P. 304)**

[IPv4 Address Filter] [Outbound Filter] <b>[Off]</b> [On] [Inbound Filter] <b>[Off]</b> [On]
[IPv6 Address Filter] [Outbound Filter] <b>[Off]</b> [On] [Inbound Filter] <b>[Off]</b> [On]
[MAC Address Filter] [Outbound Filter] <b>[Off]</b> [On] [Inbound Filter] <b>[Off]</b> [On]

## [Web Service Setup]

[Menu] ▶ [Preferences] ▶ [Network]

Specify whether to use the Canon cloud integration service.

- To use the Canon cloud integration service, you must register the machine to a dedicated server. You can use [Issue Registration Code] to issue a code to use for registration.

\* Depending on the country or region, this service may not be available and the available applications may vary.

[Web Service Usage] <input type="radio"/> [Off] <input type="radio"/> [On]  [Issue Registration Code]
---

## [Web Service Inquiry]

[Menu] ▶ [Preferences] ▶ [Network]

The machine accesses the server of the Canon cloud integration service to see if the sent print data is available. If print data is available, printing is performed.

\* Depending on the country or region, this service may not be available and the available applications may vary.

## [RMT-SW]

[Menu] ▶ [Preferences] ▶ [Network]

Normally, use the machine with this set to [Off].

When your service representative carries out device maintenance remotely, he or she may change this to [On].

<input type="radio"/> [Off] <input type="radio"/> [On]
---

## [Initialize Network Settings]

[Menu] ▶ [Preferences] ▶ [Network]

Use this to restore the network settings to the factory settings. **▶ Initializing Specific Settings and Data(P. 371)**

## [Wireless LAN Settings]

94WS-0A0

Specify the settings for connecting the machine to a wireless LAN and to save energy while the machine is connected to a wireless LAN.

\* Values in bold red text are the default settings for each item.

▶ [Select Network](P. 391)

▶ [Other Connections](P. 391)

▶ [Connection Settings](P. 392)

### [Select Network]

[Menu] ▶ [Preferences] ▶ [Network] ▶ [Wireless LAN Settings]

Select a wireless LAN router (access point) from the displayed list and enter the network key to connect. ▶ **Connecting to a Wireless LAN by Searching for a Router (Access Point Setup Method)(P. 62)**

### [Other Connections]

[Menu] ▶ [Preferences] ▶ [Network] ▶ [Wireless LAN Settings]

Connect to the wireless LAN by a method other than selecting the wireless LAN router from a list.

#### [Manually Enter Network Name]

[Menu] ▶ [Preferences] ▶ [Network] ▶ [Wireless LAN Settings] ▶ [Other Connections]

Connect to a wireless LAN router by manually entering all the router information, such as the SSID, network key and security settings. ▶ **Connecting to a Wireless LAN by Setting the Details (Manual Setup Method)(P. 65)**

[Security Settings]
[None]
[WEP]
<b>[Open System]</b>
Encryption keys 1 to 4
[Shared Key]
Encryption keys 1 to 4
[WPA/WPA2-PSK]
<b>[Auto]</b>
[AES-CCMP]
[WPA/WPA2-EAP]

#### [WPS Push Button Mode]

[Menu] ▶ [Preferences] ▶ [Network] ▶ [Wireless LAN Settings] ▶ [Other Connections]

Connect to a wireless LAN by pressing a button on a LAN router that supports WPS push button mode. ▶ **Connecting to a Wireless LAN by Using the Router Button (Push Button Mode)(P. 57)**

#### [WPS PIN Code Mode]

[Menu] ▶ [Preferences] ▶ [Network] ▶ [Wireless LAN Settings] ▶ [Other Connections]



Connect to a wireless LAN router that supports WPS PIN code mode by registering a PIN code generated by the machine. Use a computer or similar device to register the PIN code. **▶ Connecting to a Wireless LAN by Entering a PIN Code (WPS PIN Code Mode)(P. 59)**

## [Connection Settings]

[Menu] ▶ [Preferences] ▶ [Network] ▶ [Wireless LAN Settings]

Configure the setting to save power when connecting by wireless LAN, and check the wireless LAN connection information.

### [Power Save Mode]

[Menu] ▶ [Preferences] ▶ [Network] ▶ [Wireless LAN Settings] ▶ [Connection Settings]

Specify whether to periodically set the machine to Power Save Mode according to signals sent from the wireless LAN router.

[Off]  
[On]

### [Connection Information]

[Menu] ▶ [Preferences] ▶ [Network] ▶ [Wireless LAN Settings] ▶ [Connection Settings]

Check data such as the security settings, as well as the wireless LAN MAC address and other connection information. **▶ Viewing the MAC Address and Connection Information of the Wireless LAN(P. 91)**

[MAC Address]  
[Wireless LAN Status]  
[Latest Error Information]  
[Channel]  
[Network Name]  
[Security Settings]  
[Power Save Mode]

## [TCP/IP Settings]

Specify the settings to use the machine on a TCP/IP network.

\* Values in bold red text are the default settings for each item.

- ▶ [IPv4 Settings](P. 393)
- ▶ [IPv6 Settings](P. 395)
- ▶ [WINS Settings](P. 396)
- ▶ [LPD Settings](P. 396)
- ▶ [RAW Settings](P. 397)
- ▶ [WSD Settings](P. 397)
- ▶ [IPP Print Settings](P. 398)
- ▶ [Use HTTP](P. 398)
- ▶ [Network Link Scan Settings](P. 398)
- ▶ [Port Number Settings](P. 398)
- ▶ [MTU Size](P. 399)

### [IPv4 Settings]

[Menu] ▶ [Preferences] ▶ [Network] ▶ [TCP/IP Settings]

Specify the settings to use the machine in an IPv4 environment.

#### [IP Address Settings]

[Menu] ▶ [Preferences] ▶ [Network] ▶ [TCP/IP Settings] ▶ [IPv4 Settings]

Set the IPv4 address either automatically or manually. ▶ **Setting IPv4 Addresses(P. 70)**

[**Auto Acquire**]  
[Select Protocol]  
[Off]  
[**DHCP**]  
[Auto IP]  
[Off]  
[**On**]

[Manually Acquire]\*<sup>1</sup>  
[IP Address]: 0.0.0.0  
[Subnet Mask]: 0.0.0.0  
[Gateway Address]: 0.0.0.0

[Check Settings]

\*<sup>1</sup> May not be displayed depending on the model, the installed options, and other settings.

#### [PING Command]

[Menu] ▶ [Preferences] ▶ [Network] ▶ [TCP/IP Settings] ▶ [IPv4 Settings]

Execute a PING command to check whether the machine can connect to devices on the network. ▶ **Checking Whether the Machine Can Connect to Network Devices(P. 88)**

#### [DNS Settings]

[Menu] ▶ [Preferences] ▶ [Network] ▶ [TCP/IP Settings] ▶ [IPv4 Settings]

Specify the DNS settings when using the machine in an environment with a Domain Name System (DNS) implemented. ▶ **Configuring DNS(P. 78)**

[DNS Server Settings]  
 [Primary DNS Server]: 0.0.0.0  
 [Secondary DNS Server]: 0.0.0.0

[DNS Host Name/Domain Name Settings]  
 [Host Name]  
 [Domain Name]

[DNS Dynamic Update Settings]  
**[Off]**  
 [On]  
 [DNS Dyn. Updt. Intrvl.]  
 0 to **24** to 48 (hr.)

### [mDNS Settings]

---

[Menu] ► [Preferences] ► [Network] ► [TCP/IP Settings] ► [IPv4 Settings]

Specify the mDNS settings to use DNS functions in an environment such as Bonjour with no DNS installed.

[Off]  
**[On]**  
 [mDNS Name]

### [DHCP Option Settings]

---

[Menu] ► [Preferences] ► [Network] ► [TCP/IP Settings] ► [IPv4 Settings]

Specify the settings for using a DHCP server in an IPv4 environment with a Domain Name System (DNS) implemented. ► **Configuring DNS(P. 78)**

[Acquire Host Name]  
 [Off]  
**[On]**

[DNS Dynamic Update]  
**[Off]**  
 [On]

[Acquire DNS Server Address]  
 [Off]  
**[On]**

[Acquire Domain Name]  
 [Off]  
**[On]**

[Acquire WINS Server Address]  
 [Off]  
**[On]**

## [IPv6 Settings]

[Menu] ▶ [Preferences] ▶ [Network] ▶ [TCP/IP Settings]

Specify the settings for using the machine in an IPv6 environment.

You can set multiple IPv6 addresses and use them at the same time. [▶Setting IPv6 Addresses\(P. 74\)](#)

### [Use IPv6]

[Menu] ▶ [Preferences] ▶ [Network] ▶ [TCP/IP Settings] ▶ [IPv6 Settings]

Configure whether to use IPv6.

[Off]  
[On]  
[Check Settings]

### [Stateless Address Settings]

[Menu] ▶ [Preferences] ▶ [Network] ▶ [TCP/IP Settings] ▶ [IPv6 Settings]

Configure whether to use a stateless address.

[Off]  
[On]  
[Check Settings]

### [Use DHCPv6]

[Menu] ▶ [Preferences] ▶ [Network] ▶ [TCP/IP Settings] ▶ [IPv6 Settings]

Configure whether to use a stateful address obtained from a DHCP server using DHCPv6.

[Off]  
[On]  
[Check Settings]

### [DNS Settings]

[Menu] ▶ [Preferences] ▶ [Network] ▶ [TCP/IP Settings] ▶ [IPv6 Settings]

Specify the DNS settings when using the machine in an environment with a Domain Name System (DNS) implemented. [▶Configuring DNS\(P. 78\)](#)

[DNS Host Name/Domain Name Settings]  
[Use IPv4 Host/Domain]  
[Off]  
[Host Name]  
[Domain Name]  
[On]  
  
[DNS Dynamic Update Settings]  
[Off]  
[On]  
[Regist. Manual Addr.]  
[Off]  
[On]

[Regist. Stateful Addr.]
<input type="checkbox"/> [Off]
<input type="checkbox"/> [On]
[Regist Stateless Addr.]
<input type="checkbox"/> [Off]
<input type="checkbox"/> [On]
[DNS Dyn. Updt. Intrvl.]
0 to <b>24</b> to 48 (hr.)

### [mDNS Settings]

[Menu] ► [Preferences] ► [Network] ► [TCP/IP Settings] ► [IPv6 Settings]

Specify the mDNS settings to use DNS functions in an environment such as Bonjour with no DNS installed.

<input type="checkbox"/> [Off]
<input checked="" type="checkbox"/> [On]
[Use IPv4 Name for mDNS]
<input type="checkbox"/> [Off]
[mDNS Name]
<input checked="" type="checkbox"/> [On]

### [DHCP Option Settings]

[Menu] ► [Preferences] ► [Network] ► [TCP/IP Settings] ► [IPv6 Settings]

Specify the settings for using a DHCP server in an IPv4 environment with a Domain Name System (DNS) implemented. **►Configuring DNS(P. 78)**

[Acquire DNS Server Address]
<input type="checkbox"/> [Off]
<input checked="" type="checkbox"/> [On]
[Acquire Domain Name]
<input type="checkbox"/> [Off]
<input checked="" type="checkbox"/> [On]

### [WINS Settings]

[Menu] ► [Preferences] ► [Network] ► [TCP/IP Settings]

Configure WINS (Windows Internet Name Service) when using the machine in a network environment that uses both NetBIOS and TCP/IP. **►Configuring WINS(P. 82)**

[WINS Resolution]
<input type="checkbox"/> [Off]
<input type="checkbox"/> [On]
[WINS Server Address]: 0.0.0.0

### [LPD Settings]

[Menu] ► [Preferences] ► [Network] ► [TCP/IP Settings]

Specify whether to use the LPD protocol. **▶Configuring LPD, RAW, or WSD(P. 342)**

If the LPD protocol is used, you can also set the time from the start of reception standby, after print data reception is canceled, to the timeout.

[LPD Print Settings]
[Off]
<b>[On]</b>
[RX Timeout]
1 to <b>5</b> to 60 (min.)

## [RAW Settings]

[Menu] ▶ [Preferences] ▶ [Network] ▶ [TCP/IP Settings]

Specify whether to use the RAW protocol. **▶Configuring LPD, RAW, or WSD(P. 342)**

If the RAW protocol is used, you can also set the time from the start of reception standby, after print data reception is canceled, to the timeout.

[RAW Print Settings]
[Off]
<b>[On]</b>
[RX Timeout]
1 to <b>5</b> to 60 (min.)

## [WSD Settings]

[Menu] ▶ [Preferences] ▶ [Network] ▶ [TCP/IP Settings]

Specify whether to use the WSD protocol. You can specify this setting for each of the functions that use the WSD protocol. **▶Configuring LPD, RAW, or WSD(P. 342)**

[WSD Print Settings]
[Use WSD Print]
[Off]
<b>[On]</b>
[Use WSD Browsing]
[Off]
<b>[On]</b>
[Use Multicast Discovery]
[Off]
<b>[On]</b>
[WSD Scan Settings]
[Use WSD Scan]
<b>[Off]</b>
[On]
[Use Computer Scan]
<b>[Off]</b>
[On]

## [IPP Print Settings]

[Menu] ▶ [Preferences] ▶ [Network] ▶ [TCP/IP Settings]

Specify whether to use IPP (Internet Printing Protocol). You can use IPP when printing and sending fax with AirPrint. ▶

**Setting the Functions and Security to Be Used with AirPrint(P. 284)**

When using IPP, you can also specify whether TLS encryption is used for communication.

[Use IPP Printing] [Off] <b>[On]</b>
[Allow IPP Printing Only When Using TLS] <b>[Off]</b> [On]

## [Use HTTP]

[Menu] ▶ [Preferences] ▶ [Network] ▶ [TCP/IP Settings]

Specify whether to use HTTP. ▶ **Disabling HTTP Communication(P. 344)**

[Off] <b>[On]</b>
----------------------

## [Network Link Scan Settings]

[Menu] ▶ [Preferences] ▶ [Network] ▶ [TCP/IP Settings]

Specify whether to use Network Link Scan. You can use Network Link Scan when scanning documents with AirPrint. ▶

**Setting the Functions and Security to Be Used with AirPrint(P. 284)**

When using Network Link Scan, you can also specify whether TLS encryption is used for communication.

\* Setting [Use Network Link Scan] to [On] enables HTTP communication. ▶ **[Use HTTP](P. 398)**

[Use Network Link Scan] <b>[Off]</b> [On]
[Use TLS] <b>[Off]</b> [On]

## [Port Number Settings]

[Menu] ▶ [Preferences] ▶ [Network] ▶ [TCP/IP Settings]

Specify the port number for the protocol used in accordance with the port numbers for the computer, server or other device. ▶ **Changing the Port Number(P. 307)**

[LPD] 1 to <b>515</b> to 65535
-----------------------------------

[RAW]  
1 to **9100** to 65535

[WSD Multicast Discovery]  
1 to **3702** to 65535

[HTTP]  
1 to **80** to 65535

[SNMP]  
1 to **161** to 65535

## [MTU Size]

[Menu] ► [Preferences] ► [Network] ► [TCP/IP Settings]

If communication slows down due to the size of the packets sent, use this to change the maximum size for outgoing packets.

[1300]  
[1400]  
[**1500**]



## [External Interface]

---

94WS-0A2

Specify the settings for USB connections.

\* Values in bold red text are the default settings for each item.

### ▶ [USB Settings](P. 400)

#### [USB Settings]

[Menu] ▶ [Preferences] ▶ [External Interface]

Specify whether to use the USB port for connecting to a computer. ▶ **Preventing Connection to Computer via USB Port(P. 341)**

[Use as USB Device]

[Off]

[**On**]

## [Accessibility]

94WS-0A3

Configure operation panel screen features such as screen color inversion and message display time to make the screen easier to see.

\* Values in bold red text are the default settings for each item.

- ▶ [Invert Screen Colors](P. 401)
- ▶ [Contrast](P. 401)
- ▶ [Message Display Time](P. 401)
- ▶ [Scrolling Speed](P. 401)
- ▶ [Cursor Movement Type](P. 402)

### [Invert Screen Colors]

[Menu] ▶ [Preferences] ▶ [Accessibility]

Specify whether light and dark on the operation panel screen are reversed.

[Off]  
[On]

### [Contrast]

[Menu] ▶ [Preferences] ▶ [Accessibility]

Adjust the contrast to make the operation panel screen easier to view.

7 levels

### [Message Display Time]

[Menu] ▶ [Preferences] ▶ [Accessibility]

Set the number of seconds for which each message is displayed when 2 messages are displayed alternately on the operation panel screen.

1 to **2** to 5 (sec.)

### [Scrolling Speed]

[Menu] ▶ [Preferences] ▶ [Accessibility]

Set the scrolling speed when operating the screen.

[Slow]  
**[Standard]**  
[Fast]

## [Cursor Movement Type]

[Menu] ▶ [Preferences] ▶ [Accessibility]

Set the cursor operation when entering text.

Set to [Auto] to move the cursor automatically to the next input field after entering text. When set to [Manual], you must press ▶ to move the cursor.

[Auto]

[Manual]

## [Volume Settings] (Touch Panel Model)

94WS-0A4

For the touch panel model, set whether the machine emits sounds notifying you of operations and statuses. ▶  
**Adjusting the Sound Volume (Touch Panel Model)(P. 167)**

- |                                |   |
|--------------------------------|---|
| ▶ [Fax Tone](P. 403)           | ▶ [Invalid Entry Tone](P. 404)                |
| ▶ [Ring Tone](P. 403)          | ▶ [Restock Supplies Tone](P. 404)             |
| ▶ [TX Done Tone](P. 403)       | ▶ [Warning Tone](P. 404)                      |
| ▶ [RX Done Tone](P. 403)       | ▶ [Job Done Tone](P. 405)                     |
| ▶ [Scanning Done Tone](P. 404) | ▶ [Energy Saver Alert](P. 405)                |
| ▶ [Entry Tone](P. 404)         | ▶ [Original in Feeder Detection Tone](P. 405) |

### [Fax Tone]

[Menu] ▶ [Preferences] ▶ [Volume Settings]

Specify whether communication sounds are emitted when sending faxes.

- Dragging the slider to the right increases the volume.
- Dragging the slider to the far left mutes the sound.

4 levels

### [Ring Tone]

[Menu] ▶ [Preferences] ▶ [Volume Settings]

Specify whether a fax reception sound is emitted.

0 (Off)  
 1 to 3

### [TX Done Tone]

[Menu] ▶ [Preferences] ▶ [Volume Settings]

Specify whether a fax transmission completion sound is emitted.

0 (Off)  
 1 to 3  
 [When Error]  
 [Off]  
 [On]

### [RX Done Tone]

[Menu] ▶ [Preferences] ▶ [Volume Settings]

Specify whether a fax reception completion sound is emitted.

0 (Off)  
**1** to 3  
 [When Error]  
 [Off]  
 [On]

## [Scanning Done Tone]

[Menu] ▶ [Preferences] ▶ [Volume Settings]

Specify whether a fax scanning completion sound is emitted.

0 (Off)  
**1** to 3  
 [When Error]  
 [Off]  
 [On]

## [Entry Tone]

[Menu] ▶ [Preferences] ▶ [Volume Settings]

Set whether to emit a sound when you press the keys and buttons on the operation panel.

[Off]  
 [On]

## [Invalid Entry Tone]

[Menu] ▶ [Preferences] ▶ [Volume Settings]

Set whether to emit a sound when an invalid key is pressed, such as when you enter a value outside the setting range.

[Off]  
 [On]

## [Restock Supplies Tone]

[Menu] ▶ [Preferences] ▶ [Volume Settings]

Set whether to emit a sound when the toner cartridge is nearing the end of their lifetime.

[Off]  
 [On]

## [Warning Tone]

[Menu] ▶ [Preferences] ▶ [Volume Settings]

Set whether to emit a sound when the machine has a paper jam or other malfunction.

[Off]  
[On]

## [Job Done Tone]

[Menu] ▶ [Preferences] ▶ [Volume Settings]

Set whether to emit a sound when the print operation on the machine is completed.

[Off]  
[On]

## [Energy Saver Alert]

[Menu] ▶ [Preferences] ▶ [Volume Settings]

Set whether to emit a sound when the machine enters and exits sleep mode.

[Off]  
[On]

## [Original in Feeder Detection Tone]

[Menu] ▶ [Preferences] ▶ [Volume Settings]

Set whether to emit a sound when an original is loaded in the feeder.

[Off]  
[On]

## [Adjustment/Maintenance]

---

94WS-0A5

Use this setting to adjust the print or copy quality and when cleaning the machine.

▶[Adjust Image Quality](P. 406)

▶[Maintenance](P. 406)

### [Adjust Image Quality]

[Menu] ▶ [Adjustment/Maintenance]

Use this setting to adjust the image quality or print position and for special processing according to the paper used.

▶[Adjust Image Quality](P. 407)

### [Maintenance]

[Menu] ▶ [Adjustment/Maintenance]

Carry out maintenance to clean the machine.

▶[Maintenance](P. 413)

## [Adjust Image Quality]

Use this setting to adjust the image quality or print position and for special processing according to the paper used.

\* Values in bold red text are the default settings for each item.

▶ **[Printer Density](P. 407)**

▶ **[Toner Save](P. 407)**

▶ **[Special Processing](P. 407)**

### [Printer Density]

[Menu] ▶ [Adjustment/Maintenance] ▶ [Adjust Image Quality]

If printed text or fine lines appear faded, adjust the density. ▶ **Adjusting the Print Density(P. 480)**

9 levels

### [Toner Save]

[Menu] ▶ [Adjustment/Maintenance] ▶ [Adjust Image Quality]

Specify whether to adjust the print quality to save toner.  
To give priority to print quality, select [Off].

**[Off]**

[On]

### [Special Processing]

[Menu] ▶ [Adjustment/Maintenance] ▶ [Adjust Image Quality]

Use a range of processes to resolve problems that arise due to factors such as the paper type, the material used, or its condition.

▶ **[Special Processing](P. 408)**



## [Special Processing]

94WS-0A7

Use a range of processes to resolve problems that arise due to factors such as the paper type, the material used, or its condition.

\* Values in bold red text are the default settings for each item.

- |  |  |
|--|--|
| ▶ [Special Paper Processing](P. 408)       | ▶ [Correct Paper Conveyance](P. 410)                 |
| ▶ [Reduce Ppr. Sticking at Output](P. 409) | ▶ [Talc Paper Mode](P. 411)                          |
| ▶ [High Humidity Mode](P. 409)             | ▶ [Correct Blurry Image for Copy](P. 411)            |
| ▶ [Low Humidity Mode](P. 409)              | ▶ [Correct Blurry Image](P. 411)                     |
| ▶ [Reduce Ghosting 1](P. 410)              | ▶ [Transfer Adjustment Mode](P. 411)                 |
| ▶ [Prevent Fogging](P. 410)                | ▶ [Reduce Faint Print After Replacing Cart.](P. 411) |
| ▶ [Reduce Toner Flaking](P. 410)           |  |

### [Special Paper Processing]

[Menu] ▶ [Adjustment/Maintenance] ▶ [Adjust Image Quality] ▶ [Special Processing]

Specify special processing for the paper in the following situations:

- If you are using special paper
  - To print on the back of printed paper
  - For paper with a rough surface
- If the envelope flap is stuck down
- If the paper curls during printing

#### [Manual Back Side Print (2-Sided Only)]

[Menu] ▶ [Adjustment/Maintenance] ▶ [Adjust Image Quality] ▶ [Special Processing] ▶ [Special Paper Processing]

If you are using paper that has already been printed on, printing on the back side may appear faint. If so, specifying [On] for that paper source may improve the print results.

\* When this is set to [On], if some time has passed since the front side of the paper was printed, or depending on the operating environment humidity, changes in image quality may occur.

[Drawer 1] <b>[Off]</b> [On]
------------------------------------

\*1 May not be displayed depending on the model, the installed options, and other settings.

#### [Rough Surface Paper Mode]

[Menu] ▶ [Adjustment/Maintenance] ▶ [Adjust Image Quality] ▶ [Special Processing] ▶ [Special Paper Processing]

if you are using paper with a rough surface, printed images may appear faint. If so, specifying [On] for that paper source may improve the print results.

\* Specifying [On] in this setting may lead to slower print speeds or changes in the image quality.

[Drawer 1]
------------

[Off]  
[On]

### [Envelope Flap Closing Prevention]

[Menu] ▶ [Adjustment/Maintenance] ▶ [Adjust Image Quality] ▶ [Special Processing] ▶ [Special Paper Processing]

Depending on the type of envelope and the operating environment, the envelope flap may stick down during printing. If so, specifying [On] in this setting may reduce the likelihood of envelope flaps sticking down.

\* If this is set to [On], the print may be faded because the toner is not fully fixed on the paper.

[Off]  
[On]

### [Paper Curl Correction]

[Menu] ▶ [Adjustment/Maintenance] ▶ [Adjust Image Quality] ▶ [Special Processing] ▶ [Special Paper Processing]

Depending on paper used, the paper may curl during printing. If so, specifying [On] in this setting may alleviate paper curling.

\* Specifying [On] in this setting may lead to faded print.

[Off]  
[On]

## [Reduce Ppr. Sticking at Output]

[Menu] ▶ [Adjustment/Maintenance] ▶ [Adjust Image Quality] ▶ [Special Processing]

In 2-sided printing involving multiple pages, printed paper sheets may stick together. If so, specifying [On] in this setting may reduce the likelihood of paper sheets sticking together.

\* This setting is also effective for 1-sided printing.

[Off]  
[On]

## [High Humidity Mode]

[Menu] ▶ [Adjustment/Maintenance] ▶ [Adjust Image Quality] ▶ [Special Processing]

Printing in a high-humidity environment may cause uneven print density. If so, specifying [On] may improve the print results.

\* Specifying [On] in this setting may lead to blurred images and/or text in low-humidity environments.

[Off]  
[On]

## [Low Humidity Mode]

[Menu] ▶ [Adjustment/Maintenance] ▶ [Adjust Image Quality] ▶ [Special Processing]

Printing in a low-humidity environment may lead to blurred images and/or text. In this case, selecting [Mode 1] may improve the print results. If that does not work, try selecting [Mode 2] and then [Mode 3].

\* Enabling this setting may reduce the density or create fading in a humid environment.

[Off]
[Mode 1]
[Mode 2]
[Mode 3]

## [Reduce Ghosting 1]

[Menu] ▶ [Adjustment/Maintenance] ▶ [Adjust Image Quality] ▶ [Special Processing]

If you print on small-sized paper and then continue printing on a larger sized paper, ghost images may appear in the unprinted sections of the paper. In this case, selecting [On] may improve the print results.

\* When you select [On], the printing speed may decrease.

[Off]
[On]

## [Prevent Fogging]

[Menu] ▶ [Adjustment/Maintenance] ▶ [Adjust Image Quality] ▶ [Special Processing]

White (blank) areas in the printed image may be darkened. If so, specifying [On] may correct the problem.

\* When you select [On], the print density may decrease.

[Off]
[On]

## [Reduce Toner Flaking]

[Menu] ▶ [Adjustment/Maintenance] ▶ [Adjust Image Quality] ▶ [Special Processing]

Depending on the paper type and operating environment, the toner in printed images may peel off. If so, specifying [Mode 1] in this setting may improve the print results. If this does not solve the problem, specify [Mode 2].

\* Enabling this setting may result in ghosting in blank areas.

[Off]
[Mode 1]
[Mode 2]

## [Correct Paper Conveyance]

[Menu] ▶ [Adjustment/Maintenance] ▶ [Adjust Image Quality] ▶ [Special Processing]

Continuous printing may result in repeated paper jams. In this case, selecting [On] may reduce the frequency of paper jams.

\* When you select [On], the printing speed may decrease.

[Off]
-------

[On]

## [Talc Paper Mode]

[Menu] ▶ [Adjustment/Maintenance] ▶ [Adjust Image Quality] ▶ [Special Processing]

When you use very dusty paper, the printed image may be faded, or streaks may appear in the image. In this case, selecting [On] may improve the print results.

\*When you select [On], the print quality may be affected.

[Off]  
[On]

## [Correct Blurry Image for Copy]

[Menu] ▶ [Adjustment/Maintenance] ▶ [Adjust Image Quality] ▶ [Special Processing]

Depending on the paper type and operating environment, copied text or images may appear blurry. In this case, selecting [Mode 1] may improve the copy results. If that does not work, try selecting [Mode 2] and then [Mode 3].

[Off]  
[Mode 1]  
[Mode 2]  
[Mode 3]

## [Correct Blurry Image]

[Menu] ▶ [Adjustment/Maintenance] ▶ [Adjust Image Quality] ▶ [Special Processing]

Smudges may appear on the printed paper. In this case, selecting [Mode 1] may improve the print results. If that does not work, try selecting [Mode 2].

[Off]  
[Mode 1]  
[Mode 2]

## [Transfer Adjustment Mode]

[Menu] ▶ [Adjustment/Maintenance] ▶ [Adjust Image Quality] ▶ [Special Processing]

Depending on the paper used, printing may appear uneven with printing in a humid environment. In this case, selecting [Mode 1] may improve the print results. If that does not work, try selecting [Mode 2].

\* When this setting is enabled, the print density may vary in an environment with low humidity.

[Off]  
[Mode 1]  
[Mode 2]

## [Reduce Faint Print After Replacing Cart.]

[Menu] ▶ [Adjustment/Maintenance] ▶ [Adjust Image Quality] ▶ [Special Processing]

## Settings Menu Items

Print may be faded immediately after installing a new replacement toner cartridge. If so, specifying [On] in this setting may improve the print results. This setting takes effect the next time a toner cartridge is replaced.

\* Specifying [On] will result in a longer delay than usual between replacing toner cartridge and being able to print.

[Off]
[On]

## [Maintenance]

---

94WS-0A8

Carry out maintenance to clean the machine.

\* Values in bold red text are the default settings for each item.

▶ **[Clean Fixing Assembly](P. 413)**

▶ **[Clean Drum](P. 413)**

### [Clean Fixing Assembly]

[Menu] ▶ [Adjustment/Maintenance] ▶ [Maintenance]

Perform this operation to clean the fixing assembly if black streaks appear on printed paper following procedures such as toner cartridge replacement. ▶ **Cleaning the Fixing Assembly(P. 468)**

### [Clean Drum]

[Menu] ▶ [Adjustment/Maintenance] ▶ [Maintenance]

If the printout is smudged, the drum may be dirty. Perform this operation to clean the drum. ▶ **Cleaning the Drum(P. 469)**

## [Function Settings]

---

Specify the settings for printing, scanning, faxing, and copying.

\* Values in bold red text are the default settings for each item.

🔍 **[Common](P. 414)**

🔍 **[Copy](P. 414)**

🔍 **[Printer](P. 414)**

🔍 **[Send](P. 414)**

🔍 **[Receive/Forward](P. 414)**

### [Common]

[Menu] ▶ [Function Settings]

Specify the settings for function operation, such as the paper source, printing, and scanning.

🔍 **[Common](P. 415)**

### [Copy]

[Menu] ▶ [Function Settings]

Specify the settings for copying.

🔍 **[Copy](P. 420)**

### [Printer]

[Menu] ▶ [Function Settings]

Specify the printer settings.

🔍 **[Printer](P. 422)**

### [Send]

[Menu] ▶ [Function Settings]

Specify the settings for sending faxes and scanned data.

🔍 **[Send](P. 430)**

### [Receive/Forward]

[Menu] ▶ [Function Settings]

Specify the settings for receiving and forwarding faxes.

🔍 **[Receive/Forward] (Touch Panel Model)(P. 441)**

## [Common]

---

94WS-0AA

Specify the settings for function operations, such as the paper source, printing and scanning.

- ▶ [Paper Feed Settings](P. 415)
- ▶ [Print Settings](P. 415)
- ▶ [Scan Settings](P. 415)
- ▶ [Generate File](P. 415)
- ▶ [Fax Setup Guide] (Touch Panel Model)(P. 415)

### [Paper Feed Settings]

[Menu] ▶ [Function Settings] ▶ [Common]

Specify the settings for the paper source.

- ▶ [Paper Feed Settings](P. 416)

### [Print Settings]

[Menu] ▶ [Function Settings] ▶ [Common]

Specify the settings for printing.

- ▶ [Print Settings](P. 417)

### [Scan Settings]

[Menu] ▶ [Function Settings] ▶ [Common]

Specify the settings for scanning.

- ▶ [Scan Settings](P. 418)

### [Generate File]

[Menu] ▶ [Function Settings] ▶ [Common]

Specify the settings for scan file generation.

- ▶ [Generate File](P. 419)

### [Fax Setup Guide] (Touch Panel Model)

[Menu] ▶ [Function Settings] ▶ [Common]

Configure the settings for faxing by following the instructions on the screen. ▶ **Configuring the Fax Settings (Fax Setup Guide) (Touch Panel Model)(P. 94)**

\* [Fax Setup Guide] may not be displayed depending on the model, the installed options, and other settings.



## [Paper Feed Settings]

94WS-0AC

Specify the settings for the paper source.

\* Values in bold red text are the default settings for each item.

### ☉ [Switch Paper Feed Method](P. 416)

#### [Switch Paper Feed Method]

[Menu] ▶ [Function Settings] ▶ [Common] ▶ [Paper Feed Settings]

Specify the settings used when printing on paper with a pre-printed logo.

Normally, when such paper is used, you need to change the direction in which the paper is loaded and which side faces up according to whether printing is 1-sided or 2-sided.

If you set [Print Side Priority] as the paper source for the loaded paper, there is no need to change the direction of the paper loaded or which side faces up. If you specify [Print Side Priority], always load the paper using the method for 2-sided printing. ☉ **Orientation for Loading Paper with a Logo(P. 137)**

\* If you specify [Print Side Priority] in this setting, 1-sided printing will be slower. If you are using paper without a pre-printed logo, or if you are not using 2-sided printing for paper with a pre-printed logo, specify [Speed Priority].

[Drawer 1] <b>[Speed Priority]</b> [Print Side Priority]
--

## NOTE

- If you specify [Print Side Priority] for a paper source containing a paper that cannot be used for 2-sided printing, that setting is disabled and the machine operates using the [Speed Priority] setting.

## [Print Settings]

---

94WS-0AE

Specify the settings for printing.

\* Values in bold red text are the default settings for each item.

### ▶ [Auto Delete Suspended Jobs](P. 417)

#### [Auto Delete Suspended Jobs]

[Menu] ▶ [Function Settings] ▶ [Common] ▶ [Print Settings]

Specify whether to automatically delete the print or copy job when an error occurs and printing stops. If you specify automatic deletion, you can also specify the time before the job is deleted.

[**Off**]

[On]

0 to **5** to 240 (min.)

## [Scan Settings]

Specify the settings for scanning.

\* Values in bold red text are the default settings for each item.

◀ [Speed/Img. Qlty. Priority for Color Scan](P. 418)

◀ [Auto Online](P. 418)

◀ [Auto Offline](P. 418)

### [Speed/Img. Qlty. Priority for Color Scan]

[Menu] ▶ [Function Settings] ▶ [Common] ▶ [Scan Settings]

Select whether to give priority to speed or print quality when scanning color originals.

<p>[<b>Speed Priority</b>] [Image Quality Priority]</p>
---

### [Auto Online]

[Menu] ▶ [Function Settings] ▶ [Common] ▶ [Scan Settings]

Specify whether the machine automatically goes online (scan standby mode) when you are scanning from a computer. If you specify [Off] in this setting, you must press [Scan] ▶ [Remote Scanner] in the operation panel [Home] screen to bring the machine online before performing the scan.

<p>[Off] [<b>On</b>]</p>
------------------------------

### [Auto Offline]

[Menu] ▶ [Function Settings] ▶ [Common] ▶ [Scan Settings]

Specify whether the machine automatically reverts to offline mode if no scan is performed for a set time after the machine is brought online (scan standby mode).

If you specify automatic reversion to offline mode, you can also specify the time before the machine goes offline.

<p>0 (Off) 1 to <b>5</b> to 60 (min.)</p>
---

## [Generate File]

---

94WS-0AH

Specify the settings for scan file generation.

\* Values in bold red text are the default settings for each item.

### ▶ [Output File Image Settings](P. 419)

## [Output File Image Settings]

[Menu] ▶ [Function Settings] ▶ [Common] ▶ [Generate File]

Specify the gamma value used when a scan file is converted to YCbCr for transmission.

Setting a gamma value that matches that of the display used by the recipient ensures that image display is faithful to the original.

[YCbCr TX Gamma Value]
[Gamma 1.0]
[Gamma 1.4]
[ <b>Gamma 1.8</b> ]
[Gamma 2.2]

## NOTE

- For information on the display's gamma value, see the manual for the display.

## [Copy]

94WS-0AJ

Specify the settings for copying.

\* Values in bold red text are the default settings for each item.

▶[Change Default Settings](P. 420)

▶[Initialize Default Settings](P. 421)

### [Change Default Settings]

[Menu] ▶ [Function Settings] ▶ [Copy]

Change the default settings for copying. ▶**Changing the Default Settings(P. 165)**

The values specified here are also restored when you press [Reset] in the copy screen

[Number of Copies]	<b>1</b> to 999
[Density]	9 levels
[Background]	[Auto]
	<b>[Adjust (Manual)]</b>
	9 levels
[Original Type]	[Text]
	<b>[Text/Photo (High Speed)]</b>
	[Text/Photo (Quality)]
	[Photo]
[2-Sided]	<b>[Off]</b>
	[1->2-Sided]
[Original/Finishing Type]	[1->2-Sided]
	[Original Orientation]
	[Portrait]
	[Landscape]
	[Finishing Type]
	[Book Type]
	[Calendar Type]
[Copy Ratio]	[Custom Ratio]
	<b>[100% (1:1)]</b>
	[400% (Max)]
	[200%]
	[141% A5->A4]

[70% A4->A5]
[50%]
[25% (Min)]
[N on 1]
[Off]
[2 on 1]
[4 on 1]
[ID Card Copy]
[Select Layout]
[Collate]
[Off]
[On]
[Erase Frame]
[Off]
[On]
[Sharpness]
7 levels

## [Initialize Default Settings]

[Menu] ► [Function Settings] ► [Copy]

Use this to restore the copy settings to the factory default values.

## [Printer]

---

94WS-0AK

Specify the printer settings.

- ▶ **[Printer Settings](P. 422)**
- ▶ **[PDL Selection (Plug and Play)] (Touch Panel Model)(P. 422)**

### [Printer Settings]

[Menu] ▶ [Function Settings] ▶ [Printer]

Specify the settings for printer operation and for processing print data.

- ▶ **[Printer Settings](P. 423)**

### [PDL Selection (Plug and Play)] (Touch Panel Model)

[Menu] ▶ [Function Settings] ▶ [Printer]

Specify which Page Description Language (PDL) to use when connecting the machine to a computer using Plug and Play.

- ▶ **[PDL Selection (Plug and Play)] (Touch Panel Model)(P. 429)**

## [Printer Settings]

Specify the settings for printer operation and for processing print data.

\* Values in bold red text are the default settings for each item.

- |  |                                      |
|--|--------------------------------------|
| ▶ <b>[Prioritize Driver Settings When Printing]</b> (P. 423) | ▶ <b>[Layout]</b> (P. 425)           |
| ▶ <b>[Copies]</b> (P. 423)                                   | ▶ <b>[Auto Error Skip]</b> (P. 427)  |
| ▶ <b>[2-Sided Printing]</b> (P. 424)                         | ▶ <b>[Timeout]</b> (P. 427)          |
| ▶ <b>[Default Paper]</b> (P. 424)                            | ▶ <b>[UFR II]</b> (P. 427)           |
| ▶ <b>[Paper Size Override]</b> (P. 424)                      | ▶ <b>[Imaging Settings]</b> (P. 428) |
| ▶ <b>[Print Quality]</b> (P. 424)                            |                                      |

### NOTE

#### If the Operation Panel and Printer Driver Have the Same Settings

- Priority is given to the printer driver settings. The operation panel settings are valid for operating systems such as UNIX printing where printer drivers cannot be used and when printing from mobile devices.

### [Prioritize Driver Settings When Printing]

[Menu] ▶ [Function Settings] ▶ [Printer] ▶ [Printer Settings]

Specify whether the printer driver settings are given priority over the paper size and type specified in [Paper Settings] in the [Home] screen.

If you specify [On] in this setting, the machine will print from the paper source specified by the printer driver, regardless of the paper setting on the machine.

Also, if [On] is specified here and the size of the paper loaded differs markedly from that specified in the printer driver settings, you can specify whether printing proceeds anyway or printing is stopped and an error message is displayed.

\* Note that specifying [On] in this setting when the paper loaded in the machine does not match the paper specified by the printer driver could lead to paper jams or printing errors.

\* Several sheets of paper may be printed even if the machine is configured to cancel printing when an error message is displayed.

[Drawer 1]
<b>[Off]</b>
[On]
[Priority Target]
<b>[Paper Size and Type]</b>
[Size Mismatch Action]
<b>[Force Output]</b>
[Display Error]
[Paper Type Only]

### [Copies]

[Menu] ▶ [Function Settings] ▶ [Printer] ▶ [Printer Settings]

Specify the number of copies to be printed.



1 to 999

## [2-Sided Printing]

[Menu] ▶ [Function Settings] ▶ [Printer] ▶ [Printer Settings]

Specify whether to print on both sides of the paper.

[Off]  
[On]

## [Default Paper]

[Menu] ▶ [Function Settings] ▶ [Printer] ▶ [Printer Settings]

Specify the paper size and type to be used when printing from a mobile device or an OS that does not support the printer driver.

See below for the papers that can be specified.

🔍 **Usable Paper(P. 19)**

## [Paper Size Override]

[Menu] ▶ [Function Settings] ▶ [Printer] ▶ [Printer Settings]

Specify whether the machine substitutes A4 size paper for Letter size paper and vice-versa when printing. Specifying [On] in this setting means that if, for example, printing on A4 size paper is specified on the computer and there is only Letter size paper loaded, the job is printed on Letter size paper instead.

\* Print settings are specified in an application or printer driver, but this setting can only be specified on the operation panel.

[Off]  
[On]

## [Print Quality]

[Menu] ▶ [Function Settings] ▶ [Printer] ▶ [Printer Settings]

Adjust print quality settings such as the density according to the document being printed and the purpose.

### [Density]

[Menu] ▶ [Function Settings] ▶ [Printer] ▶ [Printer Settings] ▶ [Print Quality]

Adjust the toner density used when printing.

For more precise adjustment, you can adjust the levels of the three density areas in [Density (Fine Adjust)].

\* Note that you cannot adjust the toner density if [Toner Save] is set to [On]. 🔍 **[Toner Save](P. 425)**

\* [Density] may not be displayed depending on the model, the installed options, and other settings.

[Density]  
17 levels

[Density (Fine Adjust)]  
[High]/[Medium]/[Low]

17 levels

**[Toner Save]**

[Menu] ▶ [Function Settings] ▶ [Printer] ▶ [Printer Settings] ▶ [Print Quality]

Specify whether to save toner when printing.

Specify [On] in this setting when you only want to check the layout or other finishing prior to the final print, such as before printing a very large job.

 [Off]  
 [On]
**[Image Refinement]**

[Menu] ▶ [Function Settings] ▶ [Printer] ▶ [Printer Settings] ▶ [Print Quality]

Specify whether to use smoothing processing that will produce smoother printed outlines in text and figures.

 [Off]  
 [On]
**[Output Adjustment Mode]**

[Menu] ▶ [Function Settings] ▶ [Printer] ▶ [Printer Settings] ▶ [Print Quality]

Specify the resolution for printing. To print at a higher resolution, specify [On].

\* Selecting [On] decreases the printing speed.

 [Off]  
 [On]
**[Layout]**

[Menu] ▶ [Function Settings] ▶ [Printer] ▶ [Printer Settings]

Specify the gutter direction or margin and the print position.

**[Binding Location]**

[Menu] ▶ [Function Settings] ▶ [Printer] ▶ [Printer Settings] ▶ [Layout]

Specify whether the gutter will be on the long edge or the short edge when the printed document will be bound using a method such as staples.

Use this setting in conjunction with the [Gutter] setting to adjust the binding position and margins. ▶ **[Gutter]** (P. 426)

- To bind the paper on the long edge, specify [Long Edge] in this setting.



- To bind the paper on the short edge, specify [Short Edge] in this setting.



[Long Edge]  
[Short Edge]

**[Gutter]**

[Menu] ▶ [Function Settings] ▶ [Printer] ▶ [Printer Settings] ▶ [Layout]

Offset the print position to adjust the width of the margin that will form the gutter. Specify the offset width in 0.5 mm increments in the plus (+) or minus (-) offset direction, in accordance with the edge specified in [Binding Location]. **▶ [Binding Location](P. 425)**

**If [Binding Location] is set to [Long Edge]**

Specify the offset width by selecting a positive (+) value to bind on the left edge of the paper or a negative (-) value to bind on the right edge.



Specified as a positive (+) value



Specified as a negative (-) value

**If [Binding Location] is set to [Short Edge]**

Specify the offset width by selecting a positive (+) value to bind on the top edge of the paper or a negative (-) value to bind on the bottom edge.



Specified as a positive (+) value



Specified as a negative (-) value

-50.0 to **00.0** to +50.0 (mm)

**[Offset Short Edge] or [Offset Long Edge]**

[Menu] ▶ [Function Settings] ▶ [Printer] ▶ [Printer Settings] ▶ [Layout]

Offset the print position of text and images. Use this setting when the printed text and images are shifted towards one edge of the paper or when they extend beyond the print range. Specify the offset width as a positive (+) or negative (-) value in 0.5 mm increments for each paper edge direction and print side.

**To Offset Along the Short Edge (Horizontally)**

Specify the adjustment width by selecting a positive (+) value to adjust to the right on the paper or a negative (-) value to adjust to the left on the paper.

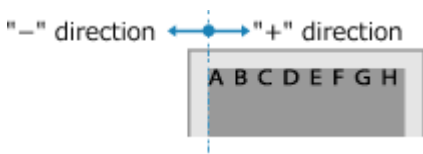

**To Offset Along the Long Edge (Vertically)**

Specify the adjustment width by selecting a positive (+) value to adjust down on the paper or a negative (-) value to adjust up on the paper.



-50.0 to **00.0** to +50.0 (mm)

## [Auto Error Skip]

[Menu] ▶ [Function Settings] ▶ [Printer] ▶ [Printer Settings]

Specify whether to continue printing if an error occurs during printing.  
It is recommended that the [Off] setting normally be used so that printing stops when an error occurs.

[Off]  
[On]

## [Timeout]

[Menu] ▶ [Function Settings] ▶ [Printer] ▶ [Printer Settings]

Specify the time from the start of waiting to receive print data until reception times out when print data reception is interrupted.

5 to **15** to 300 (sec.)

## [UFR II]

[Menu] ▶ [Function Settings] ▶ [Printer] ▶ [Printer Settings]

Specify the print data processing method used when the UFR II Printer Driver is used.

### [Halftones]

[Menu] ▶ [Function Settings] ▶ [Printer] ▶ [Printer Settings] ▶ [UFR II]

Specify the print method used to reproduce halftones (intermediate areas between light and dark areas) according to the print data content.

#### To print at high definition with clear text outlines

Specify [Resolution]. This is useful for printing files with text and fine lines.

To print at a higher resolution than the [Resolution] setting, specify [High Resolution]. This is useful for printing data with fine lines and small text, such as CAD files.

\* Selecting [High Resolution] may reduce the consistency of textures.

#### To print with highlighted contrast between light and dark areas

Specify [Color Tone]. This is useful for printing image files such as photos.

#### To print with smoother gradations and outlines

Specify [Gradation]. This is useful for printing files such as figures that use tonal gradations.

[Resolution/Gradation]\*1  
[Text]  
[Resolution]  
[Color Tone]  
[Gradation]  
[High Resolution]  
[Graphics]  
[Resolution]  
[Color Tone]  
[Gradation]  
[High Resolution]

[Image]
[Resolution]
<b>[Color Tone]</b>
[Gradation]
[High Resolution]

\*1 May not be displayed depending on the model, the installed options, and other settings.

## [Paper Save]

---

[Menu] ▶ [Function Settings] ▶ [Printer] ▶ [Printer Settings] ▶ [UFR II]

Specify whether to disable output for blank pages included in the print data.

[Off]
<b>[On]</b>

## [Imaging Settings]

[Menu] ▶ [Function Settings] ▶ [Printer] ▶ [Printer Settings]

Specify the print data processing method used for printing JPEG or TIFF format image files.

### [Halftones]

---

[Menu] ▶ [Function Settings] ▶ [Printer] ▶ [Printer Settings] ▶ [Imaging Settings]

Specify the print method used to reproduce halftones (intermediate areas between light and dark areas) according to the image content.

**To print with highlighted contrast between light and dark areas**

Specify [Gradation]. This is useful for printing image files such as photos.

**To print with smoother gradations and outlines**

Specify [Resolution]. This is useful for printing files such as figures that use tonal gradations.

**To print at high definition with clear text outlines**

Specify [High Resolution]. This is useful for printing files with text and fine lines.

<b>[Gradation]</b>
[Resolution]
[High Resolution]

## [PDL Selection (Plug and Play)] (Touch Panel Model)

94WS-0AR

Specify which Page Description Language (PDL) to use when the machine is connected to a computer using Plug and Play.

\* Values in bold red text are the default settings for each item.

### 🔍[Network](P. 429)

#### [Network]

[Menu] ▶ [Function Settings] ▶ [Printer] ▶ [PDL Selection (Plug and Play)]

Specify the Page Description Language (PDL) to use when the machine is connected to a networked computer using Plug and Play.

- To connect the machine as a fax machine, specify [FAX] in this setting.
- To connecting the machine as a UFR II printer, specify [UFR II] in this setting.

[FAX]
[ <b>UFR II</b> ]

## [Send]

---

94WS-0AS

Specify the settings for sending scanned data and faxes.

- ▶ [Common Settings](P. 430)
- ▶ [Scan and Send Settings](P. 430)
- ▶ [Fax Settings](P. 430)

### [Common Settings]

[Menu] ▶ [Function Settings] ▶ [Send]

Specify the settings for restricting the transmission of scanned data and faxes, and for displaying a destination confirmation screen.

- ▶ [Common Settings] (Touch Panel Model)(P. 431)

### [Scan and Send Settings]

[Menu] ▶ [Function Settings] ▶ [Send]

Specify the settings for sending scanned data.

- ▶ [Scan and Send Settings](P. 433)

### [Fax Settings]

[Menu] ▶ [Function Settings] ▶ [Send]

Specify the settings for sending faxes.

- ▶ [Fax Settings] (Touch Panel Model)(P. 435)

\* [Fax Settings] may not be displayed depending on the model, the installed options, and other settings.

## [Common Settings] (Touch Panel Model)

94WS-0AU

Specify the settings for restricting the transmission of faxes, and for displaying the confirmation screen when sending data.

\* Values in bold red text are the default settings for each item.

- ▶ [Restrict New Destinations](P. 431)
- ▶ [Restrict Resending from Log](P. 431)
- ▶ [One-Touch/Coded Dial TX Confirmation](P. 431)
- ▶ [Confirm Destination Before Sending](P. 431)
- ▶ [Display Notif. When Job Is Accepted](P. 432)

### [Restrict New Destinations]

[Menu] ▶ [Function Settings] ▶ [Send] ▶ [Common Settings]

Specify whether to restrict the destinations that can be specified when sending faxes to destinations that are registered in the Address Book. ▶ **Limiting Available Destinations(P. 324)**

[Off]  
[On]

### [Restrict Resending from Log]

[Menu] ▶ [Function Settings] ▶ [Send] ▶ [Common Settings]

Specify whether to prohibit the specification of destinations from the TX Job Log for fax jobs. ▶ **Limiting Available Destinations(P. 324)**

[Off]  
[On]

### [One-Touch/Coded Dial TX Confirmation]

[Menu] ▶ [Function Settings] ▶ [Send] ▶ [Common Settings]

Specify whether the registered destination confirmation screen is shown when the destination is specified using a Coded Dial number ▶ **Confirming the Destination before Sending(P. 326)**

[Off]  
[On]

### [Confirm Destination Before Sending]

[Menu] ▶ [Function Settings] ▶ [Send] ▶ [Common Settings]

Specify whether a destination confirmation screen is shown when you send a fax. ▶ **Confirming the Destination before Sending(P. 326)**

[Off]  
[On]  
[Only for Sequential Broadcast]



## [Display Notif. When Job Is Accepted]

[Menu] ▶ [Function Settings] ▶ [Send] ▶ [Common Settings]

Processes handled by the machine, including sending faxes are managed as jobs. Select whether to display the screen for confirming reception as a job after fax operations are performed.  
When you select [On], you can display a screen to view the sending status and log.

[Off]

[On]

## [Scan and Send Settings]

Specify the settings for scanned data.

\* Values in bold red text are the default settings for each item.

### 🔍 [Shortcut Key Settings](P. 433)

#### [Shortcut Key Settings]

[Menu] ▶ [Function Settings] ▶ [Send] ▶ [Scan and Send Settings]

This registers the scan type and the computer where scanned data will be saved to a shortcut key so that you can quickly perform a scan from the [Home] screen.

#### Touch Panel Model

[Register]
[Scan ▶ PC1]
[Scan ▶ PC2]
<b>[Off]</b>
[USB Connection]
[Color Scan]
[Black & White Scan]
[Custom 1]
[Custom 2]
[Network Connection]
[Color Scan]
[Black & White Scan]
[Custom 1]
[Custom 2]
[Confirm Destination]
[Scan ▶ PC1]
[Scan ▶ PC2]

#### 5 Lines LCD Model

[Register]
[Scan ▶ PC]
<b>[Off]</b>
[USB Connection]
[Color Scan]
[Black & White Scan]
[Custom 1]
[Custom 2]
[Network Connection]
[Color Scan]
[Black & White Scan]
[Custom 1]

[Custom 2]  
[Confirm Destination]  
[Scan ▶ PC]

## [Fax Settings] (Touch Panel Model)

94WS-0AX

Specify the settings for sending faxes.

\* Values in bold text are the default settings for each item.

\* [Fax Settings] may not be displayed depending on the model, the installed options, and other settings.

- ▶ [Change Default Settings](P. 435)
- ▶ [Off-Hook Alarm](P. 435)
- ▶ [ECM TX](P. 435)
- ▶ [Set Pause Time](P. 436)
- ▶ [Auto Redial](P. 436)
- ▶ [Check Dial Tone Before Sending](P. 437)
- ▶ [Set Line](P. 437)
- ▶ [TX Start Speed](P. 437)
- ▶ [R-Key Setting](P. 438)
- ▶ [Confirm Entered Fax Number](P. 438)
- ▶ [Allow Fax Driver TX](P. 438)
- ▶ [Use Address Book When On-Hook](P. 438)
- ▶ [Restrict Sequential Broadcast](P. 439)
- ▶ [Register Log Dest to Addr Book](P. 439)
- ▶ [TX Terminal ID](P. 439)
- ▶ [Auto Adjust VoIP Comm. Speed](P. 439)

### [Change Default Settings]

[Menu] ▶ [Function Settings] ▶ [Send] ▶ [Fax Settings]

Change the default settings for sending Faxes. ▶ **Changing the Default Settings(P. 165)**

When you press [Reset] in the fax send screen, the settings revert to the values specified here.

[Resolution]
[ <b>200 x 100 dpi (Normal)</b> ]
[200 x 200 dpi (Fine)]
[200 x 200 dpi (Photo)]
[200 x 400 dpi (Superfine)]
[Density]
9 levels
[Sharpness]
7 levels

### [Off-Hook Alarm]

[Menu] ▶ [Function Settings] ▶ [Send] ▶ [Fax Settings]

Adjust the volume of the alarm tone sounded when a telephone or the optional TELEPHONE 6 KIT is connected and the receiver or handset is left off the hook.

- Dragging the slider to the right increases the volume.
- Dragging the slider to the far left mutes the sound.

4 levels

### [ECM TX]

[Menu] ▶ [Function Settings] ▶ [Send] ▶ [Fax Settings]

ECM (Error Correction Mode) is a function that conducts checking and correction to ensure that corrupted images are not sent when an error occurs during image transmission. Here, specify whether the ECM function is used for transmissions.

- If you use ECM transmission, error checking is carried out by both the sender and recipient during communication, so the ECM function must also be enabled at the receiving end.
- ECM transmission may slow down communication because error checking and corrections are carried out during transmission. Note also that even when ECM transmission is enabled, errors may still occur depending on the state of the phone lines.
- Enable ECM reception on the machine to reduce the number of errors that occur when the machine receives data.  **[ECM RX](P. 444)**

[Off]  
[On]

## [Set Pause Time]

[Menu] ► [Function Settings] ► [Send] ► [Fax Settings]

Specify the number of seconds (wait time) in the pause inserted between numbers.

- To send a fax to an overseas destination, enter the international access number, country code, and fax number in that order. If the call will not connect, insert a pause between the different numbers.
- If you still cannot connect after inserting a pause, change the pause time.

\* Depending on your country or region, the [Set Pause Time] setting may not be available, or its content or default setting may be different.

1 to **4** to 15 (sec.)

## [Auto Redial]

[Menu] ► [Function Settings] ► [Send] ► [Fax Settings]

Specify whether the machine automatically redials if it fails to make a connection for reasons such as the line being busy.

If you specify Auto Redial, you can also specify the number of redials, the interval between redials, and whether to redial if a transmission error occurs.

\* Depending on your country or region, the [Auto Redial] setting may not be displayed, or its content or default setting may be different.

[Off]  
[On]  
[No. of Times to Redial]  
1 to **2** to 10 (times)  
[Redial Interval]  
**2** to 99 (min.)  
[Redial When Err Occurs]  
[Off]  
[On]

## [Check Dial Tone Before Sending]

[Menu] ▶ [Function Settings] ▶ [Send] ▶ [Fax Settings]

Specify whether to check for a dial tone before dialing when sending a fax.

[Off]  
[On]

## [Set Line]

[Menu] ▶ [Function Settings] ▶ [Send] ▶ [Fax Settings]

Specify the machine's fax number, unit name, and the number of lines.

\* The fax number and unit name are sent to the recipient as sender information. ▶[TX Terminal ID](P. 439)

### [Register Unit Telephone Number]

[Menu] ▶ [Function Settings] ▶ [Send] ▶ [Fax Settings] ▶ [Set Line]

Register the fax number of the machine. ▶**Changing the Fax Number and Unit Name(P. 217)**

### [Register Unit Name]

[Menu] ▶ [Function Settings] ▶ [Send] ▶ [Fax Settings] ▶ [Set Line]

Register the name (unit name) sent to the other party. ▶**Changing the Fax Number and Unit Name(P. 217)**

### [Select Line Type]

[Menu] ▶ [Function Settings] ▶ [Send] ▶ [Fax Settings] ▶ [Set Line]

If the machine is connected to a Private Branch Exchange (PBX) or to a line that is shared with a home phone or business phone, the line type may not be selected automatically. If so, select [Manual] and specify the line type.

\* Normally, if you connect the machine to a phone line and restart the machine, the line type is selected automatically. ▶**Configuring the Fax Settings (Fax Setup Guide) (Touch Panel Model)(P. 94)**

\* Depending on your country or region, the [Select Line Type] setting may not be displayed, or its content or default setting may be different.

[Pulse]  
[Tone]

## [TX Start Speed]

[Menu] ▶ [Function Settings] ▶ [Send] ▶ [Fax Settings]

It may take some time for transmission to begin due to factors such as a poor phone line connection. If this occurs, adjust the initial communication speed to a lower level.

[33600 bps]  
[14400 bps]  
[9600 bps]  
[7200 bps]  
[4800 bps]

[2400 bps]

## [R-Key Setting]

[Menu] ▶ [Function Settings] ▶ [Send] ▶ [Fax Settings]

If the machine is connected through a PBX (Private Branch Exchange), it is necessary to set the access method. If you set the machine to [PBX], the [R] key will be displayed on the Fax Basic Features screen. If you assign an outside line access number to the [R] key, you can easily access the outside line.

\* Select [PBX] when you want the machine to be connected through a PBX (Private Branch Exchange). Set the function of the [R] key displayed on the Fax Basic Features screen to [Prefix] or [Hooking]. If you select [Prefix], register the prefix code on the next screen. Enter the prefix code using the numeric keys, select [Pause], and then select [Apply]. If you do not insert a pause, the prefix code is not registered.

[PSTN]  
 [PBX]\*1  
 [Prefix]  
 Prefix Code  
 [Hooking]

\*1 Depending on your country or region, the setting may not be displayed, or its content or default setting may be different.

## [Confirm Entered Fax Number]

[Menu] ▶ [Function Settings] ▶ [Send] ▶ [Fax Settings]

Specify whether a screen for re-entering the number appears when you enter a fax number using the numeric keys. ▶ **Confirming the Destination before Sending(P. 326)**

[Off]  
 [On]

## [Allow Fax Driver TX]

[Menu] ▶ [Function Settings] ▶ [Send] ▶ [Fax Settings]

Specify whether to allow faxes to be sent from a computer (PC faxing). ▶ **Prohibit Fax Sending from a Computer(P. 328)**

[Off]  
 [On]

## [Use Address Book When On-Hook]

[Menu] ▶ [Function Settings] ▶ [Send] ▶ [Fax Settings]

When sending faxes manually, specify [Always Allow] to enter a specific number with the numeric keys, and then specify a destination registered in the Address Book.

[Do Not Allow After Numeric Key Use]  
 [Always Allow]

## [Restrict Sequential Broadcast]

[Menu] ▶ [Function Settings] ▶ [Send] ▶ [Fax Settings]

Specify whether to prohibit fax transmission to multiple destinations (Sequential Broadcast). **▶ Prohibiting Fax Sending to Multiple Destinations(P. 328)**

[Off]  
[On]

## [Register Log Dest to Addr Book]

[Menu] ▶ [Function Settings] ▶ [Send] ▶ [Fax Settings]

Specify whether to restrict destinations remaining in the TX Job Log so they cannot be registered in the Address Book. **▶ Prohibiting Registering Fax Sending Log Destinations to Address Book(P. 336)**

[Allow]  
[Do Not Allow]

## [TX Terminal ID]

[Menu] ▶ [Function Settings] ▶ [Send] ▶ [Fax Settings]

Specify whether to include sender information such as the transmission date and time and the machine's fax number in fax headers.

If you specify [On] in this setting, you can also specify the print position for the sender information and mark the fax number.

- Set [Print Position] to [Inside Image Area] to align the print position with the top of the text or images on transmitted pages. To print the sender information beyond the top of the text or images on transmitted pages, specify [Outside Image Area].
- To post the machine's fax number as a telephone number, set [Mark No. as: TEL/FAX] to [TEL].

[Off]  
[On]  
[Print Position]  
[Inside Image Area]  
[Outside Image Area]  
[Mark No. as: TEL/FAX]  
[FAX]  
[TEL]

## [Auto Adjust VoIP Comm. Speed]

[Menu] ▶ [Function Settings] ▶ [Send] ▶ [Fax Settings]

For more secure fax transmission and reception in VoIP communication systems that are prone to communication errors, specify [On] in this setting.

\* Specifying [On] will lower the communication speed.



[Off]  
[On]

## [Receive/Forward] (Touch Panel Model)

---

94WS-0AY

Specify the settings for receiving and forwarding faxes.

▶ **[Common Settings](P. 441)**

▶ **[Fax Settings](P. 441)**

### [Common Settings]

[Menu] ▶ [Function Settings] ▶ [Receive/Forward]

Specify the settings for Memory Lock operation with faxes.

▶ **[Common Settings] (Touch Panel Model)(P. 442)**

### [Fax Settings]

[Menu] ▶ [Function Settings] ▶ [Receive/Forward]

Specify the settings for receiving and forwarding faxes.

▶ **[Fax Settings] (Touch Panel Model)(P. 444)**

\* [Fax Settings] may not be displayed depending on the model, the installed options, and other settings.

## [Common Settings] (Touch Panel Model)

94WS-0C0

Specify the settings for Memory Lock operation with faxes.

\* Values in bold text are the default settings for each item.

▶ [Set Fax Inbox](P. 442)

▶ [Continue Print. When Amount in Cart. Low](P. 442)

▶ [Print RX Page Footer](P. 443)

### [Set Fax Inbox]

[Menu] ▶ [Function Settings] ▶ [Receive/Forward] ▶ [Common Settings]

Specify the settings for fax Memory Lock.

\* [Set Fax Inbox] may not be displayed depending on the model, the installed options, and other settings.

### [Fax Memory Lock Settings]

[Menu] ▶ [Function Settings] ▶ [Receive/Forward] ▶ [Common Settings] ▶ [Set Fax Inbox]

Instead of immediately printing received faxes, you can temporarily save them in the machine's memory. ▶  
**Saving Received Documents in the Machine (Memory Lock) (Touch Panel Model)(P. 331)**

[Off]

[On]

[Use Fax Preview]

[Off]

[On]

[Report Print]

[Off]

[On]

[Memory Lock Time]

[Off]

[On]

[Memory Lock Start Time]

[Memory Lock End Time]

### [Continue Print. When Amount in Cart. Low]

[Menu] ▶ [Function Settings] ▶ [Receive/Forward] ▶ [Common Settings]

Specify whether to print received faxes when a toner cartridge is low on toner.

- Printing when a toner cartridge is low on toner may lead to print results that are faint or faded. For this reason, this should normally be set to [Off]. When this setting is used and toner is low, received faxes are stored in the machine's memory.
- If [On] is specified in this setting, received faxes are not stored in the machine's memory. If this leads to print results that are too faint to read, you will need to ask the sender to re-send the fax.

[Off]

[On]

## [Print RX Page Footer]

[Menu] ▶ [Function Settings] ▶ [Receive/Forward] ▶ [Common Settings]

Select whether to print the received date and time, page number, and other reception information at the bottom of faxes.

▶ **Changing the Print Settings for Received Faxes(P. 233)**

[Off]  
[On]

## [Fax Settings] (Touch Panel Model)

94WS-0C1

Specify the settings for receiving and forwarding faxes.

\* Values in bold red text are the default settings for each item.

\* [Fax Settings] may not be displayed depending on the model, the installed options, and other settings.

- ▶ [Print on Both Sides](P. 444)
- ▶ [ECM RX](P. 444)
- ▶ [Incoming Ring](P. 444)
- ▶ [Remote RX](P. 445)
- ▶ [Switch to Auto RX](P. 445)
- ▶ [RX Start Speed](P. 445)
- ▶ [Reduce RX Size](P. 446)
- ▶ [Forwarding Settings](P. 446)

### [Print on Both Sides]

[Menu] ▶ [Function Settings] ▶ [Receive/Forward] ▶ [Fax Settings]

Specify whether to use 2-sided printing for received Faxes.

[Off]
[On]

### [ECM RX]

[Menu] ▶ [Function Settings] ▶ [Receive/Forward] ▶ [Fax Settings]

ECM (Error Correction Mode) is a function that conducts checking and correction to ensure that corrupted images are not sent when an error occurs during image reception. Here, specify whether the ECM function is used for reception.

- If you use ECM reception, error checking is carried out by both the sender and recipient during communication, so the ECM function must also be enabled at the sender's end.
- ECM reception may slow down communication because error checking and correction are conducted during communication. Note also that even when ECM reception is enabled, errors may still occur depending on the state of the phone lines.
- Enable ECM transmission on the machine to reduce the number of errors that occur when the machine sends data. ▶ [ECM TX](P. 435)

[Off]
[On]

### [Incoming Ring]

[Menu] ▶ [Function Settings] ▶ [Receive/Forward] ▶ [Fax Settings]

Specify whether the machine sounds an incoming ring tone if a fax is received when the fax RX mode is set to [Auto] or [Fax/Tel (Auto Switch)].

If you specify [On] in this setting, you can also specify the number of times the incoming ring tone sounds.

\* Specifying [Off] will prevent the use of sleep mode.

[Off]
[On]
[No. of Rings]* <sup>1</sup>
1 to 2 to 99 (times)

\*<sup>1</sup> Depending on your country or region, the setting may not be displayed, or its content or default setting may be different.

## [Remote RX]

[Menu] ▶ [Function Settings] ▶ [Receive/Forward] ▶ [Fax Settings]

Specify whether a telephone connected to the machine can be used to receive faxes (Remote RX). ▶ **Receiving Faxes via Telephone (Remote RX)(P. 232)**

If you specify [On] in this setting, you can also specify the number used for the external telephone (Remote RX ID).

\* Depending on your country or region, the [Remote RX] setting may not be displayed, or its content or default setting may be different.

[Off]
[On]
[Remote RX ID]
00 to 25 to 99

## [Switch to Auto RX]

[Menu] ▶ [Function Settings] ▶ [Receive/Forward] ▶ [Fax Settings]

Specify whether the machine switches to automatic receive mode (Auto RX) after a set period of time if you do not pick up the receiver for an incoming fax when the fax receive mode is set to [Manual].

If you specify [On] in this setting, you can also specify how long (in seconds) the incoming ring tone sounds before the machine switches to Auto RX.

[Off]
[On]
[Ring Time Till Auto RX]
1 to 15 to 99 (sec.)

## [RX Start Speed]

[Menu] ▶ [Function Settings] ▶ [Receive/Forward] ▶ [Fax Settings]

It may take some time for reception to begin due to factors such as a poor phone line connection. If this occurs, adjust the initial communication speed to a lower level.

[33600 bps]
[14400 bps]
[9600 bps]
[7200 bps]
[4800 bps]

[2400 bps]

## [Reduce RX Size]

[Menu] ► [Function Settings] ► [Receive/Forward] ► [Fax Settings]

Specify whether to reduce images when printing or saving received faxes.

- Set the reduction ratio to [Auto] in this setting to reduce images to fit the paper size.
- When specifying the reduction ratio, set a value between [97%] and [75%].
- To maintain the aspect ratio in reduced images, set the reduction direction to [Vertical/Horizontal]. To reduce images in the vertical direction only, specify [Vertical Only].

[Off]

[On]

[Reduction Ratio]

[Auto]

[97%]

[95%]

[90%]

[75%]

[Reduction Direction]

[Vertical/Horizontal]

[Vertical Only]

## [Forwarding Settings]

[Menu] ► [Function Settings] ► [Receive/Forward] ► [Fax Settings]

Specify the settings for forwarding faxes. ► **Auto Forwarding and Backing Up Received Faxes(P. 219)**

### [Enable Forwarding Settings]

[Menu] ► [Function Settings] ► [Receive/Forward] ► [Fax Settings] ► [Forwarding Settings]

Specify whether the content of received faxes is automatically forwarded or saved to a preset destination. If you specify [On] in this setting, also specify the forwarding or save destination and, if needed, the file name.

[Off]

[On]

[Forwarding Destination:]

[File Name:]

### [Print Images]

[Menu] ► [Function Settings] ► [Receive/Forward] ► [Fax Settings] ► [Forwarding Settings]

Specify whether to print forwarded faxes. You can also opt to print only faxes that cannot be forwarded.

[Off]

[On]

[Only When Error Occurs]

### **[Store Images in Memory]**

---

[Menu] ▶ [Function Settings] ▶ [Receive/Forward] ▶ [Fax Settings] ▶ [Forwarding Settings]

Specify whether faxes that could not be forwarded due to an error are stored in the machine's memory.

[Off]

[Only When Error Occurs]



## [Set Destination] (Touch Panel Model)

---

94WS-0C2

Specify the settings for the Address Book PIN.

▶[Address Book PIN](P. 448)

### [Address Book PIN]

[Menu] ▶ [Set Destination]

Specify that a PIN must be entered to add new entries to the Address Book or edit existing entries. ▶**Restricting Address Book Registration and Editing by Setting a PIN(P. 335)**

# [Management Settings]

94WS-0C3

Specify the settings for managing the machine users, the system, and other data.

- ▶[User Management](P. 449)
- ▶[Device Management](P. 449)
- ▶[Remote UI Settings/Update Firmware](P. 449)
- ▶[Data Management](P. 449)
- ▶[Security Settings](P. 449)
- ▶[Initialize All Data/Settings](P. 449)

## [User Management]

[Menu] ▶ [Management Settings]

Register and manage information on the machine's administrator.

- ▶[User Management](P. 451)

## [Device Management]

[Menu] ▶ [Management Settings]

Specify and manage the settings for information and operations relating to the machine's hardware.

- ▶[Device Management](P. 452)

## [Remote UI Settings/Update Firmware]

[Menu] ▶ [Management Settings]

Specify and manage the settings for information and operations relating to the machine's software.

- ▶[Remote UI Settings/Update Firmware](P. 455)

## [Data Management]

[Menu] ▶ [Management Settings]

Manage or initialize stored data and the machine's settings.

- ▶[Data Management](P. 457)

## [Security Settings]

[Menu] ▶ [Management Settings]

Specify and manage the security settings, such as the machine's authentication functions and system verification.

- ▶[Security Settings](P. 458)

## [Initialize All Data/Settings]

[Menu] ▶ [Management Settings]

Initialize the settings and registered data to reset the machine to the factory settings.  **Initializing the Settings and Data(P. 371)**

# [User Management]

---

94WS-0C4

Register and manage information on the machine's administrator.

\* Values in bold red text are the default settings for each item.

▶ **[System Manager Information Settings](P. 451)**

## [System Manager Information Settings]

[Menu] ▶ [Management Settings] ▶ [User Management]

Specify a System Manager ID and System Manager PIN to create a dedicated administrator account.

If needed, you can also specify the administrator's name.

Use Remote UI from a computer to specify other administrator information, such as the e-mail address. ▶ **Setting the Department ID and PIN for the Administrator(P. 301)**

\* By default, the System Manager ID and System Manager PIN are not set. ▶ **System Manager ID and PIN(P. 6)**

[System Manager ID and PIN] [System Manager ID] [System Manager PIN]  [System Manager Name]
---

## [Device Management]

94WS-0C5

Specify and manage settings for information and operations relating to the machine's hardware.

\* Values in bold red text are the default settings for each item.

- ▶ [Device Information Settings](P. 452)
- ▶ [Select Country/Region](P. 452)
- ▶ [Display Job Log](P. 453)
- ▶ [Displ. Consmbls. Info (RUI/Toner Status)](P. 453)
- ▶ [Scan with Canon PRINT Business](P. 453)
- ▶ [Notify to Check Paper Settings](P. 454)
- ▶ [Canon Genuine Mode](P. 454)

### [Device Information Settings]

[Menu] ▶ [Management Settings] ▶ [Device Management]

Specify a name to identify the machine and the installation location.

The information specified here appears in the Remote UI Portal page. ▶ **Portal Page of Remote UI(P. 351)**

[Device Name]
[Location]

### [Select Country/Region]

[Menu] ▶ [Management Settings] ▶ [Device Management]

Specify the country or region where the machine is used. The default setting may vary depending on the setting selected at initial power-ON.

\* Depending on your country or region, the [Select Country/Region] setting may not be available, or its content or default setting may be different.

[Austria (AT)]	[Luxembourg (LU)]
[Belarus (BY)]	[Netherlands (NL)]
[Belgium (BE)]	[Norway (NO)]
[Czech Republic (CZ)]	[Poland (PL)]
[Denmark (DK)]	[Portugal (PT)]
[Egypt (EG)]	[Russia (RU)]
[Finland (FI)]	[Saudi Arabia (SA)]
[France (FR)]	[Slovenia (SI)]
[Germany (DE)]	[South Africa (ZA)]
<b>[Great Britain (GB)]</b>	[Spain (ES)]
[Greece (GR)]	[Sweden (SE)]
[Hungary (HU)]	[Switzerland (CH)]
[Ireland (IE)]	[United Arab Emirates (AE)]
[Italy (IT)]	[Ukraine (UA)]
[Jordan (JO)]	[Other]

## [Display Job Log]

[Menu] ▶ [Management Settings] ▶ [Device Management]

Specify whether the logs for printing and faxing are shown on the Status Monitor screen and in the communication management reports.

▶ **[Status Monitor] Screen(P. 116)**

▶ **Checking Usage and Logs with Remote UI(P. 353)**

▶ **Printing and Viewing Reports and Lists(P. 358)**

[Off]  
[On]

## [Displ. Consmbls. Info (RUI/Toner Status)]

[Menu] ▶ [Management Settings] ▶ [Device Management]

Specify whether a button that accesses sites for purchasing toner cartridges is displayed in Toner Status and Remote UI. You can also specify whether Toner Status is used.

- Specify whether to show the button in Remote UI in [Displ. Consumables Purchase Button (RUI)].
- Specify whether to use Toner Status in [Toner Status] in the [Toner Status Settings].
- If you opt to use Toner Status, use [Displ Cnsmb1 Purch Btn] in the [Toner Status Settings] to specify whether to show the button.

Toner Status sends notification of the remaining amount of toner in the machine to the computer on which the tool is installed. Download Toner Status from the Canon website for your country/region, and install it on your computer.

**<https://global.canon/en/support/>**

\* If the machine is supplied with a CD-ROM or DVD-ROM, you can also use this to install Toner Status.

[Displ. Consumables Purchase Button (RUI)]  
[Off]  
[On]

[Toner Status Settings]  
[Off]  
[On]  
[Displ Cnsmb1 Purch Btn]  
[Off]  
[On]

## [Scan with Canon PRINT Business]

[Menu] ▶ [Management Settings] ▶ [Device Management]

Specify whether the machine's scanning functions can be used from a mobile device with Canon PRINT Business installed.

[Off]  
[On]

## [Notify to Check Paper Settings]

[Menu] ▶ [Management Settings] ▶ [Device Management]

Specify whether the Notify to Check Paper Settings screen appears when the paper drawer is loaded into the machine.

▶ **Loading Paper in the Paper Drawer(P. 133)**

[Off]  
[On]

## [Canon Genuine Mode]

[Menu] ▶ [Management Settings] ▶ [Device Management]

Specify whether to switch to Canon Genuine Mode.

- Normally, there is no need to change this setting.
- Your Canon service representative may change this setting. If this setting is not displayed, contact the machine's administrator.

[Off]  
[On]

## [Remote UI Settings/Update Firmware]

94WS-0C6

Specify and manage the settings for information and operations relating to the machine's software.

▶ [Remote UI Settings](P. 455)

▶ [Update Firmware](P. 455)

### [Remote UI Settings]

[Menu] ▶ [Management Settings] ▶ [Remote UI Settings/Update Firmware]

Specify the settings for using Remote UI and for Restrict Access for Remote UI.

▶ [Remote UI Settings](P. 456)

### [Update Firmware]

[Menu] ▶ [Management Settings] ▶ [Remote UI Settings/Update Firmware]

Check the machine's firmware version and update the firmware via the Internet or a computer.

▶ **Updating the Firmware (Touch Panel Model)(P. 365)**

▶ **Updating the Firmware (5 Lines LCD Model)(P. 368)**

[Via PC]

[Via Internet]

[Version Information]

[Notification Settings]

[Off]

[**On**]



## [Remote UI Settings]

94WS-0C7

Specify the settings for using Remote UI and for Restrict Access for Remote UI.

\* Values in bold text are the default settings for each item.

▶ **[Use Remote UI](P. 456)**

▶ **[Remote UI Access Security Settings](P. 456)**

### [Use Remote UI]

[Menu] ▶ [Management Settings] ▶ [Remote UI Settings/Update Firmware] ▶ [Remote UI Settings]

Specify whether to use Remote UI. ▶ **[Disabling Remote UI(P. 338)]**

If you opt to use Remote UI, you can also specify whether to use TLS encryption for communication when using Remote UI. ▶ **[Using TLS(P. 310)]**

[Off]
<b>[On]</b>
[Use TLS]
<b>[Off]</b>
[On]

### [Remote UI Access Security Settings]

[Menu] ▶ [Management Settings] ▶ [Remote UI Settings/Update Firmware] ▶ [Remote UI Settings]

When using Remote UI, set this setting to [On], and set the Remote UI Access PIN. ▶ **[Setting the PIN to Use for Remote UI(P. 337)]**

<b>[Off]</b>
[On]
[Remote UI Access PIN]

## [Data Management]

94WS-0C8

Manage or initialize the data and settings on the machine.  
 \* Values in bold red text are the default settings for each item.

- ▶ [Enable Product Extended Survey Program](P. 457)
- ▶ [Initialize Key and Certificate](P. 457)
- ▶ [Initialize Address Book] (Touch Panel Model)(P. 457)
- ▶ [Initialize Menu](P. 457)

### [Enable Product Extended Survey Program]

[Menu] ▶ [Management Settings] ▶ [Data Management]

Specify whether to use the Product Extended Survey Program (a program for surveying machine usage).

The Product Extended Survey Program is installed at the same time as the drivers. It automatically sends monthly updates of information on device usage to Canon over a 10-year period. The program does not send personal information or any information other than that shown above.

[Off]  
 [On]

### [Initialize Key and Certificate]

[Menu] ▶ [Management Settings] ▶ [Data Management]

Initialize the key and certificate settings and CA certificate settings, and delete all keys and certificates other than pre-installed ones. ▶ **Initializing Specific Settings and Data(P. 371)**

### [Initialize Address Book] (Touch Panel Model)

[Menu] ▶ [Management Settings] ▶ [Data Management]

Delete the destinations registered in the Address Book. ▶ **Initializing Specific Settings and Data(P. 371)**

### [Initialize Menu]

[Menu] ▶ [Management Settings] ▶ [Data Management]

Initialize the [Menu] settings in the [Home] screen. Select the settings to be initialized. ▶ **Initializing Specific Settings and Data(P. 371)**

[Preferences]  
 [Adjustment/Maintenance]  
 [Function Settings]  
 [Set Destination] (Touch Panel Model)  
 [Management Settings]  
 [Initialize All]

## [Security Settings]

Specify and manage security settings such as the machine's authentication functions and system verification.

\* Values in bold red text are the default settings for each item.

▶ [Authentication/Password Settings](P. 458)

▶ [Encryption Settings](P. 458)

▶ [Verify System at Startup](P. 458)

### [Authentication/Password Settings]

[Menu] ▶ [Management Settings] ▶ [Security Settings]

Configure the authentication functions for the machine.

▶ [Authentication/Password Settings](P. 459)

### [Encryption Settings]

[Menu] ▶ [Management Settings] ▶ [Security Settings]

Specify whether to restrict the use of weak encryption or keys and certificates that use weak encryption.

[Prohibit Use of Weak Encryption]

[**Off**]

[On]

[Prohibit Key/Cert. with Weak Encryption]

[**Off**]

[On]

### [Verify System at Startup]

[Menu] ▶ [Management Settings] ▶ [Security Settings]

Verify that the system has not been tampered with when starting up the machine.

#### **If Tampering is Detected**

- The machine switches to update standby mode. You need to update the firmware.
  - ▶ **Updating the Firmware (Touch Panel Model)(P. 365)**
  - ▶ **Updating the Firmware (5 Lines LCD Model)(P. 368)**
- If the screen remains blank after some time, system recovery may not be possible. Contact your dealer or service representative. ▶ **If the Problem Persists(P. 581)**

[**Off**]

[On]

# [Authentication/Password Settings]

---

94WS-0CA

Specify the settings for the machine's authentication functions.

\* Values in bold red text are the default settings for each item.

## 🔍 [Authentication Function Settings](P. 459)

### [Authentication Function Settings]

[Menu] ▶ [Management Settings] ▶ [Security Settings] ▶ [Authentication/Password Settings]

Specify the settings for enhanced security using the authentication functions.

#### [Lockout Settings]

[Menu] ▶ [Management Settings] ▶ [Security Settings] ▶ [Authentication/Password Settings] ▶ [Authentication Function Settings]

Specify whether to switch to a state that does not permit login (lockout) for a set period if authentication fails. If you use lockout, you can also specify how many consecutive times authentication fails before lockout is invoked in [Lockout Threshold] and specify the length of the lockout period in [Lockout Period].

[Enable Lockout]

**[Off]**

[On]

[Lockout Threshold]

**1** to 10 (times)

[Lockout Period]

**1** to 60 (min.)

# Maintenance

<b>Maintenance</b> .....	461
<b>Cleaning the Machine</b> .....	463
Cleaning the Surface of the Machine .....	464
Cleaning the Platen Glass .....	465
Cleaning the Feeder .....	466
Cleaning the Fixing Assembly .....	468
Cleaning the Drum .....	469
<b>Replacing Consumables</b> .....	470
Replacing the Toner Cartridge .....	471
Checking the Remaining Amount of Consumables .....	477
List of Consumables .....	478
<b>Adjusting the Print Density</b> .....	480
<b>Moving the Machine</b> .....	482

# Maintenance

94WS-0CC

To ensure safe and convenient use of the machine, daily maintenance that includes cleaning and replacement of consumables is required.

If you notice a deterioration in the print quality or frequent paper jams, perform cleaning and adjustment to improve it.

## Performing Maintenance Operations

In addition to performing regular maintenance, operations are required according to the machine status and print quality.

### Cleaning

Regularly clean the various parts of the machine. If the original or paper becomes dirty, or the print quality has deteriorated, clean the parts causing the problem according to the symptoms.

🔍 **Cleaning the Machine(P. 463)**

### Replacing Consumables

If a message about consumables appears on the screen of the operation panel or Remote UI, or the print quality deteriorates, replace the consumables.

🔍 **Replacing Consumables(P. 470)**

### Adjusting the Print Density

If printed text or fine lines appear faded, adjust the print density.

🔍 **Adjusting the Print Density(P. 480)**

## Changing the Installation Location

When moving the machine, perform the prescribed procedure to prevent accident or damage.

🔍 **Moving the Machine(P. 482)**

## ! IMPORTANT

### Maintenance and Inspections

- The minimum holding period for performance parts for repairs and toner cartridges is seven (7) years after production of the machine model is discontinued.
- If a problem occurs during operation, see the following:
  - 🔍 **Troubleshooting(P. 486)**

If the problem still cannot be resolved or you think the machine needs to be checked, contact your dealer or service representative. 🔍 **If the Problem Persists(P. 581)**

### Installation

- If you find the machine's operation to be noisy in some operating modes or due to your surroundings, we recommend setting up the machine in a separate location from your office.
- Water droplets (condensation) may form inside the machine if the room where the machine is installed is heated rapidly, or if the machine is moved from a cool, dry location to a warm, humid location. Using the machine under these conditions may result in problems such as paper jams, poor print quality, or faults. Allow the machine adjust to the ambient temperature and humidity for at least two hours before use.
- Machines with storage devices such as hard disks may not operate properly when used at high altitudes (3,000 meters above sea level or higher).

## ■ See Also

### Checking the Required Troubleshooting Solutions from the Symptoms

You can check the required maintenance operations and settings according to the status of the machine and the error description.

- ▶ **Paper Jams(P. 487)**
- ▶ **Problems with Printing Results(P. 496)**
- ▶ **Paper and Paper Feeding Problems(P. 519)**

**Viewing the Number of Printed Pages and Machine Usage**

As a guide to when to perform maintenance, you can view the number of printed pages using the counter and view the usage of the machine from reports and lists.

- ▶ **Monitoring the Usage(P. 355)**

# Cleaning the Machine

To ensure efficient use of the machine, regularly clean the various parts and keep them clean. If the original or paper becomes dirty, or the print quality has deteriorated, clean the parts causing the problem according to the symptoms.

## Parts to Clean on a Regular Basis

Regularly clean the upper surfaces of the machine (a) and the underside of the platen glass/feeder or platen glass cover (b).

▶ **Cleaning the Surface of the Machine(P. 464)**

▶ **Cleaning the Platen Glass(P. 465)**

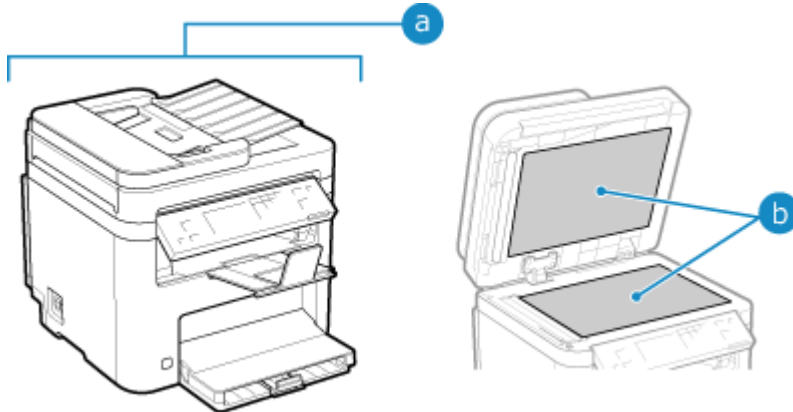

## Parts to Clean When Symptoms Occur

If the following symptoms occur, clean the feeder (c) or fixing assembly and drum (d) inside the machine.

- Original becomes dirty, paper is jammed, or smudges appear on printouts.
  - ▶ **Cleaning the Feeder(P. 466)**
- Paper becomes dirty or print quality has deteriorated.
  - ▶ **Cleaning the Fixing Assembly(P. 468)**
  - ▶ **Cleaning the Drum(P. 469)**

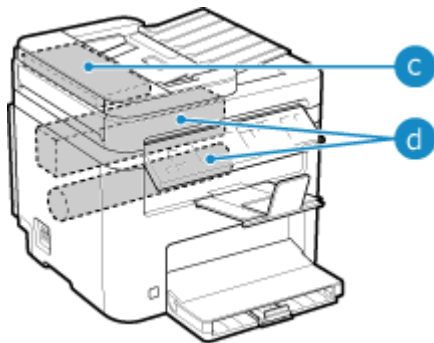



## Cleaning the Surface of the Machine

---

94WS-OCF

Regularly clean the surface of the machine to keep it clean. In addition, remove dust from the ventilation holes to ensure efficient ventilation and cooling of the inside of the machine.

### 1 Turn OFF the power and remove the power cord from the outlet. ▶Turning OFF the Machine(P. 104)

Turning OFF the machine deletes any data waiting to be printed.

### 2 Wipe the surface of the machine and the ventilation slots.



- Wipe with a soft cloth soaked in water or diluted neutral detergent and wrung out.
- For the location of the ventilation slots, see the part names on the front of the machine. ▶Front Side(P. 10)

### 3 Allow the parts to fully dry.

### 4 Plug the power cord into the outlet, and turn ON the machine. ▶Turning ON the Machine(P. 103)

## Cleaning the Platen Glass

Regularly clean the platen glass and feeder or the rear of the platen glass cover to prevent originals from becoming dirty and printouts from appearing to be smudged. If the platen glass, feeder or the rear of the platen glass cover is dirty, originals can become dirty and printouts can appear smudged after scanning, copying, or sending faxes.

- 1 Turn OFF the power and remove the power cord from the outlet. ▶Turning OFF the Machine(P. 104)**

Turning OFF the machine deletes any data waiting to be printed.

- 2 Open the feeder or platen glass cover.**

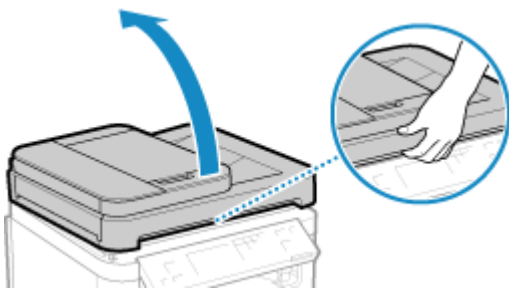

- 3 Wipe the platen glass and the underside of the feeder or platen glass cover.**

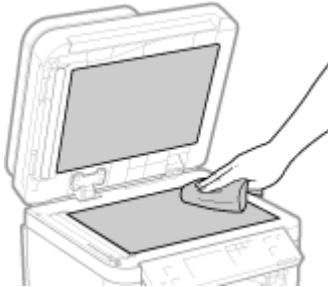

Wipe with a cloth soaked in water and wrung out. Next, wipe with a soft, dry cloth.

- 4 Allow the parts to fully dry.**

- 5 Gently close the feeder or platen glass cover.**

- 6 Plug the power cord into the outlet, and turn ON the machine. ▶Turning ON the Machine(P. 103)**

## Cleaning the Feeder

If any of the symptoms below occur when using the feeder, wipe the rollers inside the feeder and the feeder original scanning area to remove any adhering graphite powder and dust.

- Originals become dirty
- Originals frequently jam
- Printouts appear smudged after scanning, copying, or sending faxes

### 1 Turn OFF the power and remove the power cord from the outlet. Turning OFF the Machine(P. 104)

Turning OFF the machine deletes any data waiting to be printed.

### 2 Open the original supply tray.

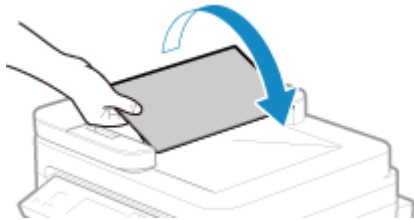

### 3 Open the feeder cover.

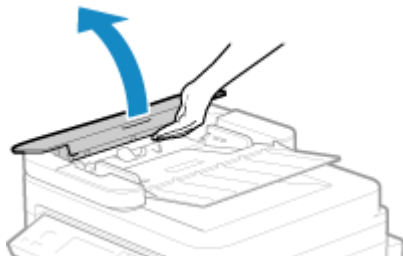

### 4 Wipe the rollers (a) inside the feeder and surrounding areas.

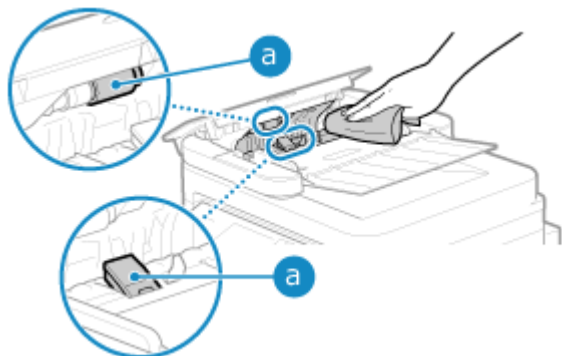

Wipe with a cloth soaked in water and wrung out. Next, wipe with a soft, dry cloth.

### 5 Close the feeder cover and original supply tray.

**6** Open the feeder.

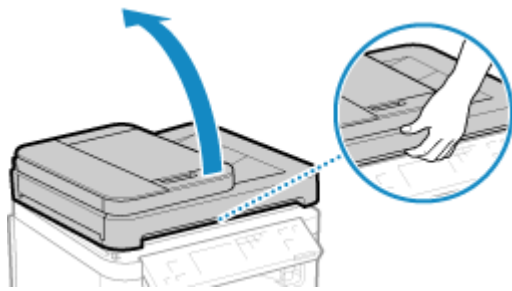

**7** Wipe the feeder original scanning area.



Wipe with a cloth soaked in water and wrung out. Next, wipe with a soft, dry cloth.

**8** Allow the parts to fully dry.

**9** Gently close the feeder.

**10** Plug the power cord into the outlet, and turn ON the machine. ▶Turning ON the Machine(P. 103)

## NOTE

- You can configure the machine to display a message when dirt is detected in the feeder's original scanning area. ▶[Notify to Clean Original Scanning Area](P. 382)

# Cleaning the Fixing Assembly

If the printout is smudged, the fixing assembly may be dirty. In this case, you can clean the fixing assembly using paper.

The fixing assembly cannot be cleaned when data is waiting to be printed or a toner cartridge has reached the end of its lifetime.

## Required Preparations

- Check that there is enough amount of toner remaining in the toner cartridge. [▶Checking the Remaining Amount of Consumables\(P. 477\)](#)

[▶Touch Panel Model\(P. 468\)](#)

[▶5 Lines LCD Model\(P. 468\)](#)

## Touch Panel Model

**1** On the operation panel, press [Menu] in the [Home] screen. [▶\[Home\] Screen\(P. 113\)](#)

**2** Press [Adjustment/Maintenance] ▶ [Maintenance] ▶ [Clean Fixing Assembly].

⇒ The available paper sizes and types are displayed on the confirmation screen.

**3** Check that available paper is loaded, and then press [Start].

⇒ The paper is fed to the machine, and cleaning starts.

When cleaning is completed, a sheet of paper with a printed image (pattern) is output.

## 5 Lines LCD Model

**1** On the operation panel, select [Menu] in the [Home] screen, and press **OK**. [▶\[Home\] Screen\(P. 113\)](#)

**2** Press [Adjustment/Maintenance] ▶ **OK** ▶ [Maintenance] ▶ **OK** ▶ [Clean Fixing Assembly] ▶ **OK**.

⇒ The available paper sizes and types are displayed on the confirmation screen.

**3** Check that available paper is loaded, and then press **OK**.

⇒ The paper is fed to the machine, and cleaning starts.

When cleaning is completed, a sheet of paper with a printed image (pattern) is output.

# Cleaning the Drum

If the printout is smudged, the drum may be dirty. Clean the drum using the procedure below. The drum cannot be cleaned when data is waiting to be printed.

▶ **Touch Panel Model(P. 469)**

▶ **5 Lines LCD Model(P. 469)**

## Touch Panel Model

**1** On the operation panel, press [Menu] in the [Home] screen. ▶ [Home] Screen(P. 113)

**2** Press [Adjustment/Maintenance] ▶ [Maintenance] ▶ [Clean Drum].

⇒ The [Clean Drum] screen is displayed.

**3** Press [Start].

⇒ Cleaning is performed.

When cleaning is completed, the message [Finished.] appears, and then the [Maintenance] screen is displayed.

## 5 Lines LCD Model

**1** On the operation panel, select [Menu] in the [Home] screen, and press **OK**. ▶ [Home] Screen(P. 113)

**2** Press [Adjustment/Maintenance] ▶ **OK** ▶ [Maintenance] ▶ **OK** ▶ [Clean Drum] ▶ **OK**.

⇒ The [Clean Drum] screen is displayed.

**3** Select [Start], and press **OK**.

⇒ Cleaning is performed.

When cleaning is completed, the message [Finished.] appears, and then the [Maintenance] screen is displayed.

# Replacing Consumables

---

94WS-0CR

If a message about consumables appears on the screen of the operation panel or Remote UI, or the print quality deteriorates, replace the consumables.

You can view the current remaining amount of consumables on the operation panel and Remote UI. For the consumable item names and number of sheets that can be printed, see the list of consumables.

- ▶ **Replacing the Toner Cartridge(P. 471)**
- ▶ **Checking the Remaining Amount of Consumables(P. 477)**
- ▶ **List of Consumables(P. 478)**

# Replacing the Toner Cartridge

94WS-0CS

Replace the toner cartridge at the appropriate time according to messages that appear and a change in print quality.

Before replacing the toner cartridge, check the precautions in Important Safety Instructions. **▶Manuals of the Machine(P. 584)**

**▶When to Replace the Toner Cartridge(P. 472)**

**▶Before Replacing Toner Cartridge(P. 472)**

**▶Replacing Toner Cartridge(P. 474)**

## CAUTION

- Do not touch the contacts (a) inside the machine. Doing so may result in a fault.

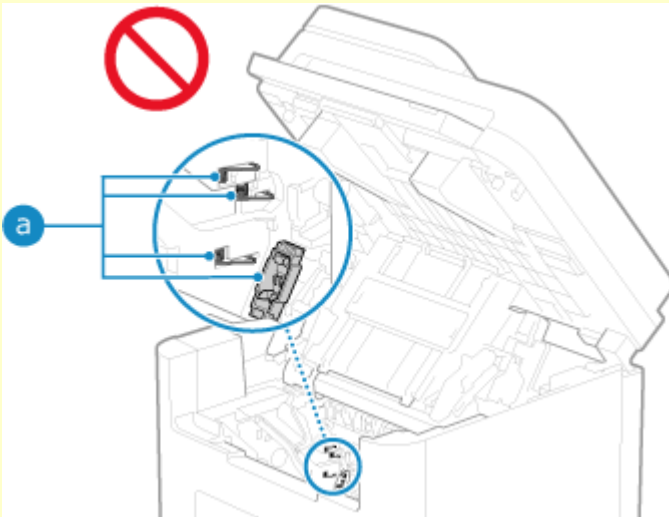

## IMPORTANT

- Be sure to hold the toner cartridge using the handle.

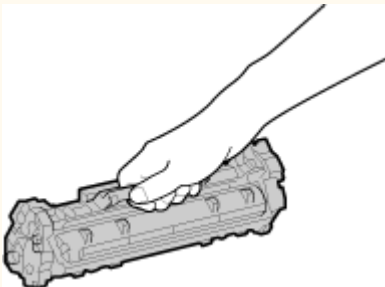

- Do not scratch the drum surface (a) or expose it to light. Also, do not touch the electrical contacts (b) or the toner cartridge memory (c).



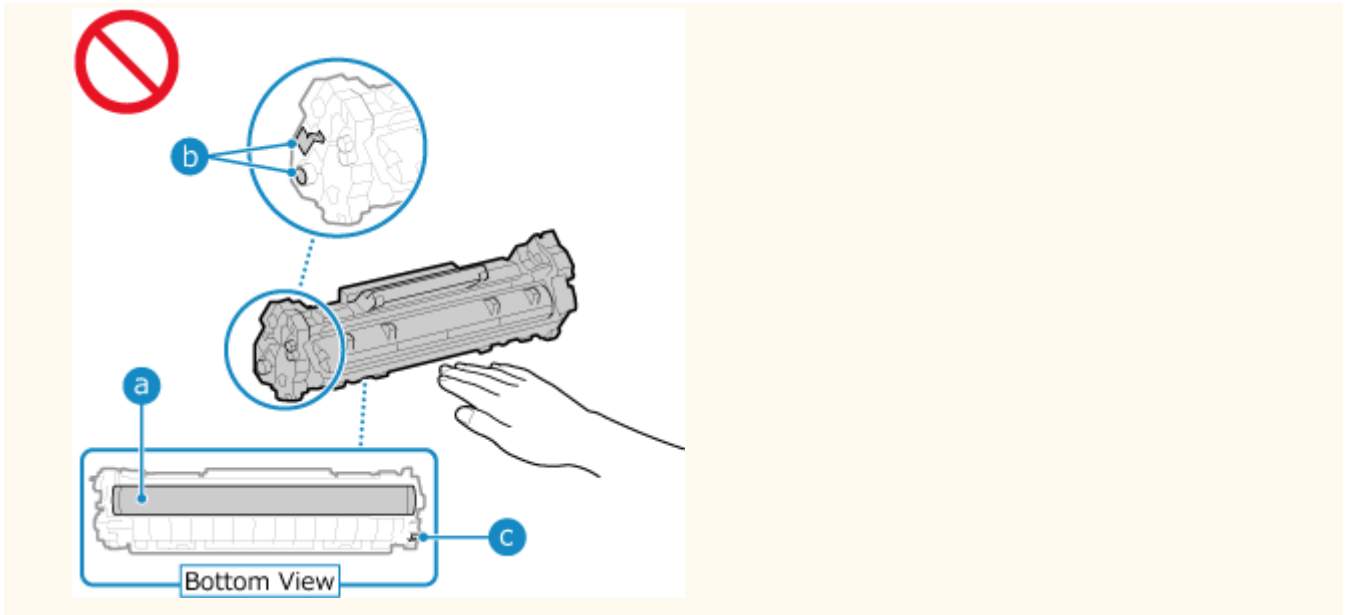

## When to Replace the Toner Cartridge

### When a Message Appears on the Screen of the Operation Panel or Remote UI

Follow the message on the screen to prepare a new toner cartridge and replace the old one. Print quality may suffer if you continue using the toner cartridge without replacing it. For details about the message and how to resolve it, see the following:

#### 🔴 A Message Appears (P. 560)

### When Print Quality Deteriorates

If printouts show any of the symptoms below, the toner cartridge is near the end of their lifetime. It is recommended to replace the toner cartridge even if a message does not appear.

#### Streaks appear



#### Printing is uneven



#### Toner smudges and splatters appear



#### White spots appear



#### Partially faded



#### The entire background is darkened



## Before Replacing Toner Cartridge

Perform the following procedure before replacing the toner cartridge. The message on the screen may disappear, and the print quality may improve.

### 1 Lift the operation panel.

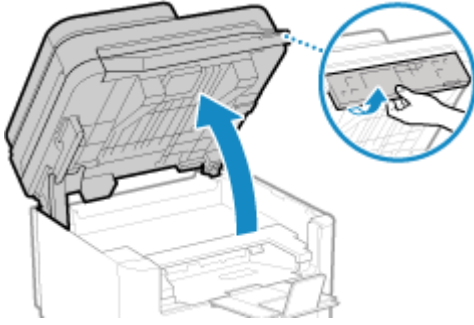

Check the following before lifting up the operation panel:

- The feeder or platen glass cover is completely closed.
  - There are no thick originals such as books placed on the platen glass.
- \* Using excessive force to raise the operation panel could cause a fault.

**2 Close the paper stopper, and then open the toner cover.**

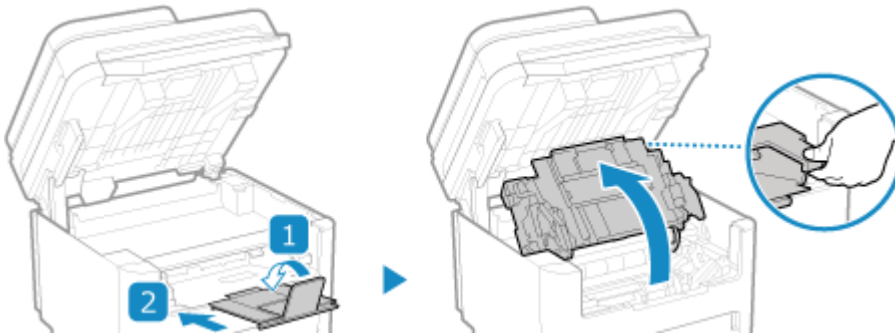

**3 Remove the toner cartridge.**

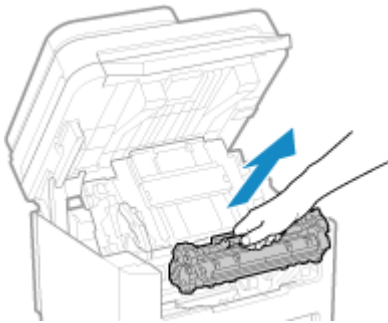

Slowly pull it out at the same angle as the slot.

**4 Shake the toner cartridge five or six times to evenly distribute the toner inside the cartridge.**

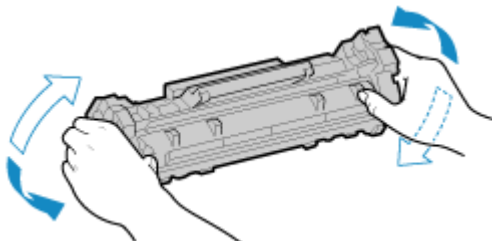

Be careful not to touch the drum surface on the bottom of the toner cartridge.

**5 Install the toner cartridge.**

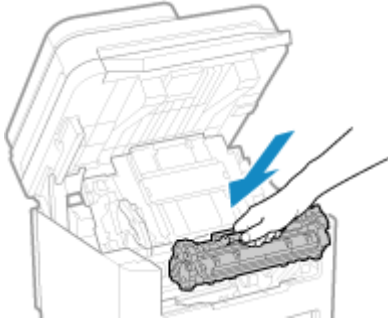

The bottom of the toner cartridge is unprotected. Be careful not to bump the bottom of the toner cartridge against the slot frame or other parts when installing.

**6 Close the toner cover.**

**7 Lower the operation panel.**

## Replacing Toner Cartridge

**1 Lift the operation panel.**

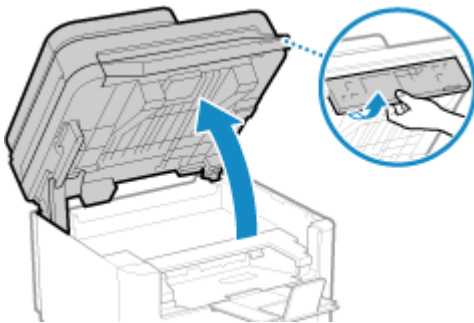

Check the following before lifting up the operation panel:

- The feeder or platen glass cover is completely closed.
  - There are no thick originals such as books placed on the platen glass.
- \* Using excessive force to raise the operation panel could cause a fault.

**2 Close the paper stopper, and then open the toner cover.**

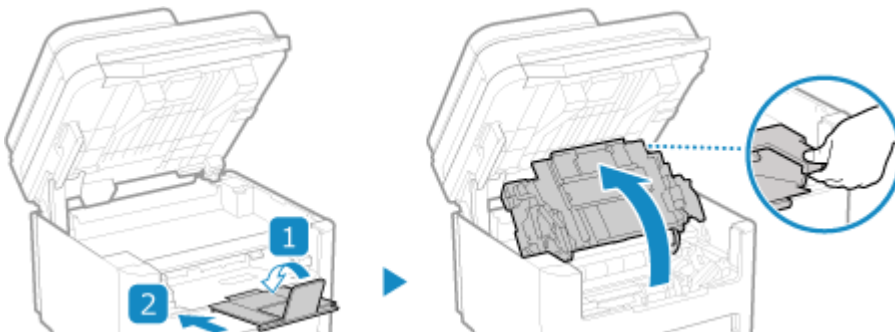

**3 Remove the toner cartridge.**

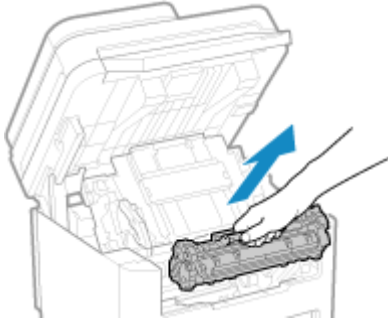

Slowly pull it out at the same angle as the slot.

**4 Remove the toner cartridge from the packing material on a level surface.**

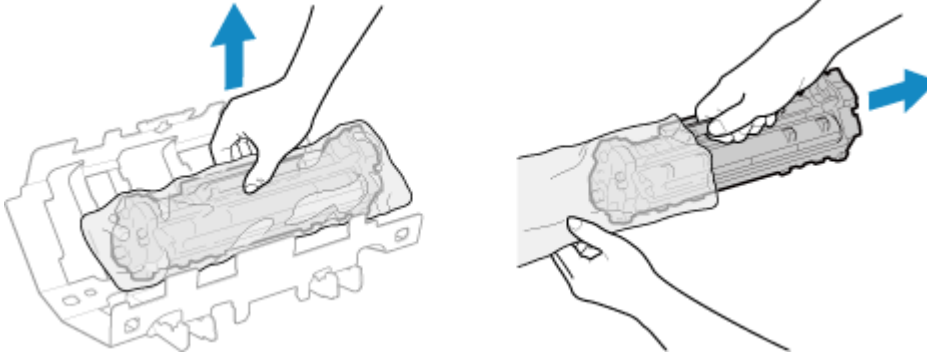

**5 Shake the toner cartridge five or six times to evenly distribute the toner inside the cartridge.**

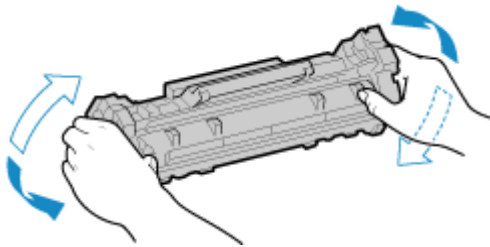

**6 Remove the protective cover of the toner cartridge.**

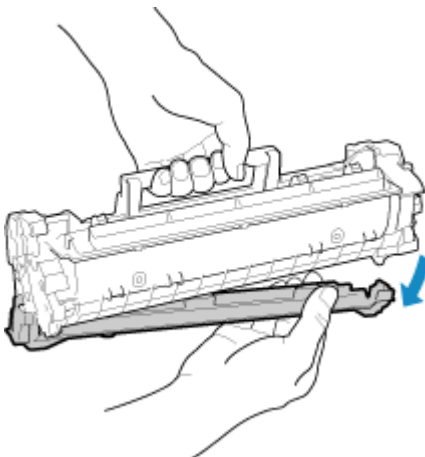

Be careful not to touch the drum surface on the bottom of the toner cartridge.

**7 Install the toner cartridge.**

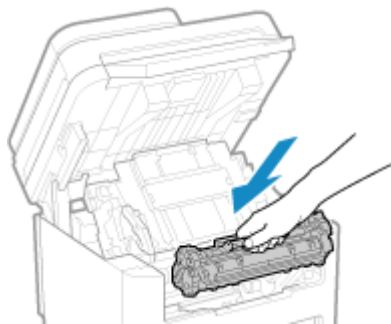

The bottom of the toner cartridge is unprotected. Be careful not to bump the bottom of the toner cartridge against the slot frame or other parts when installing.

**8** Close the toner cover.

**9** Lower the operation panel.

# Checking the Remaining Amount of Consumables

94WS-0CU

You can view the percentage of the current remaining amount of toner in the toner cartridge in increments of 10%. Check the remaining amount of toner in the toner cartridge, for example, to see if you need to prepare a new toner cartridge before printing a large volume document.

\* The displayed value for the remaining amount of toner in the toner cartridge is for reference and may not indicate the actual amount remaining.

This section describes how to view this information using the operation panel.

You can also check this information using Remote UI from a computer. ▶ **Managing the Machine from a Computer (Remote UI)(P. 348)**

▶ **Touch Panel Model(P. 477)**

▶ **5 Lines LCD Model(P. 477)**

## Touch Panel Model

**1** Press  on the operation panel. ▶ **Operation Panel(P. 14)**

**2** Press [Device Status] ▶ [Cartridge Level].

⇒ The remaining amount of toner in the toner cartridge is displayed by the color.

**3** Check the remaining amount of toner in the toner cartridge.

## 5 Lines LCD Model

**1** On the operation panel, press [Status Monitor] in the [Home] screen ▶ . ▶ [Home] Screen(P. 113)

**2** Press [Device Status] ▶  ▶ [Cartridge Level] ▶ .

⇒ The remaining amount of toner in the toner cartridge is displayed.

**3** Check the remaining amount of toner in the toner cartridge.

## NOTE

- You can configure the settings to notify you to prepare a new toner cartridge when the current toner cartridge reaches a specified amount. ▶ **[Displ. Timing for Cartridge Prep. Notif.](P. 381)**

# List of Consumables

94WS-0CW

The item names of the machine consumables and number of sheets that can be printed are shown below. In addition, precautions must be taken when handling and storing consumables. See also "Important Safety Instructions."  **Manuals of the Machine(P. 584)**

For optimum print quality, using Canon genuine Toner, Cartridge and Parts is recommended.



## ■ Toner Cartridge

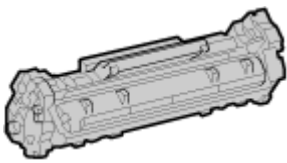

### Supplied Toner Cartridge

The average number of sheets that can be printed\*<sup>1</sup> with the supplied toner cartridge is shown below.

\*<sup>1</sup> The average yield is based on "ISO/IEC 19752" (the global standard related to "Method for the determination of toner cartridge yield for monochromatic electrophotographic printers and multi-function devices that contain printer components" issued by International Organization for Standardization (ISO)) when printing A4 size plain paper with the default print density setting.

700 sheets

### Replacement Toner Cartridge

The Canon genuine toner cartridge for replacement and average number of sheets that can be printed\*<sup>1</sup> are shown below.

For optimum print quality, using Canon genuine toner cartridges is recommended.

\*<sup>1</sup> The average yield is based on "ISO/IEC 19752" (the global standard related to "Method for the determination of toner cartridge yield for monochromatic electrophotographic printers and multi-function devices that contain printer components" issued by International Organization for Standardization (ISO)) when printing A4 size plain paper with the default print density setting.

#### Canon Cartridge 071

1200 sheets

#### Canon Cartridge 071 H

2500 sheets

## CAUTION

Store toner cartridge as described below. Storing toner cartridge in an improper location or environment may cause problems such as data loss.

- Store unopened until immediately prior to use.
- Do not store toner cartridge upright or upside down.

 **CAUTION**

- Do not store toner cartridge in the following locations:
  - Locations exposed to open flames
  - Locations exposed to direct sunlight or bright light for five minutes or more
  - Locations exposed to excessively salty air
  - Locations heavily exposed to corrosive gases (e.g. aerosol sprays or ammonia)
  - Very hot and/or humid locations
  - Locations subject to dramatic changes in temperature and humidity likely to cause condensation
  - Very dusty locations
  - Locations within the reach of children
  - Locations close to products affected by magnetism (e.g. floppy disks or disk drives)
- Store the packaging material safely for future use. It will be needed for situations such as storing the machine with the toner cartridge removed.
- Canon reserves the right to reposition, reshape, add, or remove packaging material without notice.
- Store toner cartridge in the following conditions:
  - Storage temperature range: -20 - 40 °C
  - Storage humidity range: 35% to 85% RH (relative humidity, condensation-free)\*1

\*1 Even within the approved storage humidity range, water droplets (condensation) may develop inside the toner cartridge if the temperatures inside and outside the toner cartridge differ. Condensation will adversely affect the print quality.

 **IMPORTANT****Be careful of counterfeit toner cartridges**

- Please be aware that there are counterfeit Canon toner cartridges in the marketplace. Use of counterfeit toner cartridge may result in poor print quality or machine performance. Canon is not responsible for any malfunction, accident or damage caused by the use of counterfeit toner cartridge. For more information, see <https://global.canon/ctc/>.

**NOTE**

- The toner cartridge may need to be replaced before reaching the average number of sheets that can be printed depending on the installation environment, paper size to be printed, and original type.
- Shortening the automatic shutdown time from the default setting (4 hours), may reduce the lifetime of the toner cartridge.



# Adjusting the Print Density

94WS-0E1

If print results are too dark or too faint, adjust the print density.

Use the operation panel to perform adjustment. You cannot perform adjustment using Remote UI from a computer.

▶ **Touch Panel Model(P. 480)**

▶ **5 Lines LCD Model(P. 480)**

## Touch Panel Model

**1** On the operation panel, press [Menu] in the [Home] screen. ▶ [Home] Screen(P. 113)

**2** Press [Adjustment/Maintenance] ▶ [Adjust Image Quality] ▶ [Printer Density].

⇒ The [Printer Density] screen is displayed.

**3** Adjust the density, and press [Apply].

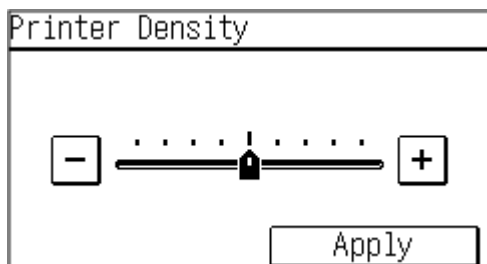

Specify [+] to increase the density and [-] to reduce it.

## 5 Lines LCD Model

**1** On the operation panel, select [Menu] in the [Home] screen, and press **OK**. ▶ [Home] Screen(P. 113)

**2** Press [Adjustment/Maintenance] ▶ **OK** ▶ [Adjust Image Quality] ▶ **OK** ▶ [Printer Density] ▶ **OK**.

⇒ The [Printer Density] screen is displayed.

**3** Adjust the density, and press **OK**.

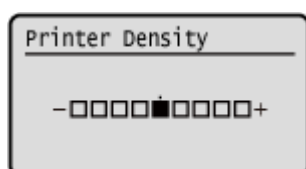

Specify [+] to increase the density and [-] to reduce it.

# Moving the Machine

94WS-0E3

The machine is a heavy object. When moving the machine for cleaning or to change locations, be sure to perform the procedure below to prevent injury, accident, or damage to the machine.

## ! IMPORTANT

- If the machine is to be transported for relocation, removals, etc., take the following steps to prevent damage and faults during transportation:
  - Remove the toner cartridge.
  - Securely pack the machine in the original packaging (box) and packing materials.

### 1 Turn OFF the machine. ▶Turning OFF the Machine(P. 104)

Turning OFF the machine deletes any data waiting to be printed.

### 2 Unplug the power cord in the order shown.

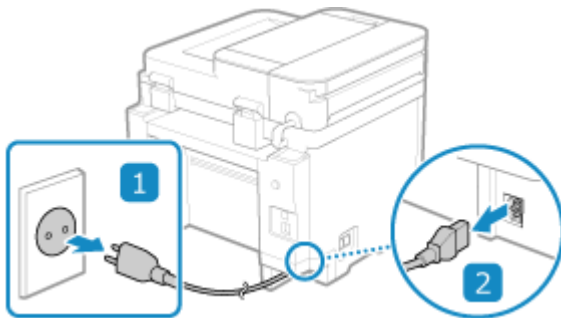

### 3 Unplug all cables and cords connected to the machine.

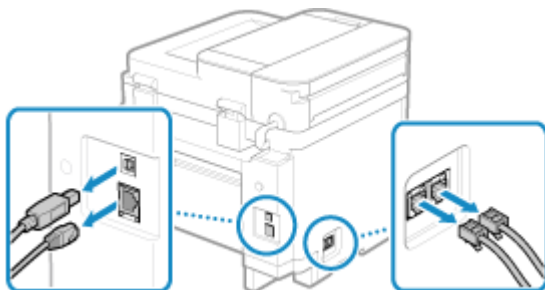

\* The number of connected cables and cords varies depending on the usage environment.

### 4 When the optional TELEPHONE 6 KIT is installed, remove the handset from the base.

### 5 When moving the machine a long distance, remove the toner cartridge to prevent spilling of toner. ▶Replacing Toner Cartridge(P. 474)

### 6 Open the paper cover and remove any paper.

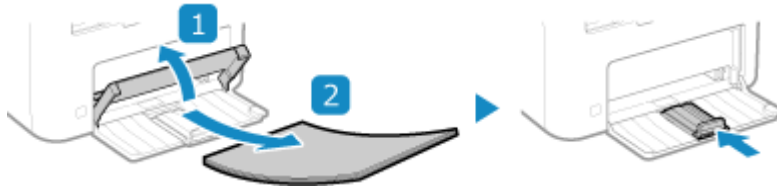

If the paper guides are extended, return them so that they fit in the drawer.

**7 Close the front cover and all other open components.**

**8 Grab the lift handles, and lift up the machine to move it.**

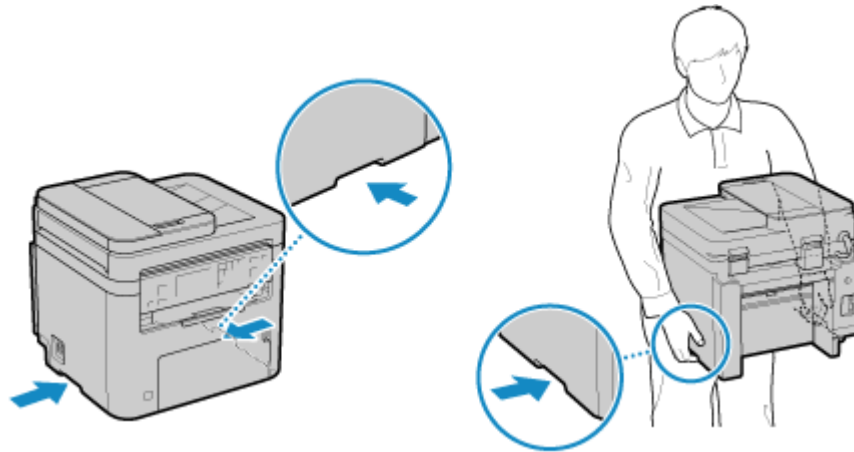

The machine is a heavy object. For the dimensions and weight of the machine, see the basic specifications. ▶ **Basic Specifications(P. 24)**

**9 Gently lower the machine.**

For the installation procedure after moving, see "Setup Guide." ▶ **Manuals of the Machine(P. 584)**

# Troubleshooting

<b>Troubleshooting</b> .....	486
<b>Paper Jams</b> .....	487
Paper Jams in the Paper Drawer, Output Tray, and Rear Side .....	489
Paper Jams in the Feeder .....	493
Paper Jams That Occur Repeatedly .....	494
<b>Problems with Printing Results</b> .....	496
Toner Smudges and Splatters Appear .....	498
Streaks Appear .....	500
Printing Is Uneven .....	502
Printed Paper Is Blank .....	504
Smudge Marks Appear on the Edge of Printouts .....	505
Text or Images Are Blurry .....	506
Printouts Have Ghost Images .....	508
Printouts Are Faded .....	510
The Edge of the Page Is Not Printed .....	512
The Background Is Generally Dark .....	513
White Spots Appear .....	514
Smudge Marks Appear on the Back Side of Printouts .....	516
Printouts Are Skewed .....	517
The Printed Barcode Cannot be Scanned .....	518
<b>Paper and Paper Feeding Problems</b> .....	519
Paper Creases .....	520
Paper Curls .....	521
Paper Is Not Fed or Two or More Sheets Are Fed Together .....	522
Printed Paper Sticks Together .....	523
<b>Setting Up</b> .....	524
The Machine Connected via WSD Port Is Not Displayed During Driver Installation .....	525
Cannot Connect to Wireless LAN .....	526
<b>Network</b> .....	527
Cannot Switch to Wireless LAN .....	528
Cannot Find the Print Server to Connect to .....	530
Cannot Connect to a Shared Printer .....	531
Cannot Find the IP Address of the Machine .....	532
AirPrint Does Not Work .....	533

**Printing and Copying** ..... 534

    Cannot Print or Copy ..... 535

        Cannot Print (Wireless LAN) ..... 536

        Cannot Print (Wired LAN) ..... 538

        Cannot Print (USB Connection) ..... 540

        Cannot Print (via Print Server) ..... 541

    Printing Is Slow ..... 542

**Scanning** ..... 543

    Cannot Save Scanned Data to a Computer ..... 544

**Faxing and Using the Telephone** ..... 546

    Cannot Send a Fax ..... 547

    Cannot Receive a Fax ..... 549

    Machine Does Not Automatically Switch Between Telephone and Fax ..... 551

    Cannot Send or Receive a Fax via Optical Line ..... 552

    Cannot Send a Fax to an International Destination ..... 553

    Other Party's Telephone or Fax Number Is Not Displayed ..... 554

**Management Functions and Environment Settings** ..... 555

    Cannot Access Remote UI ..... 556

    Changing the Time Until Sleep Mode ..... 557

    Lost Department ID or PIN for the Administrator ..... 558

    Checking the Items That Can Be Configured on the Machine and Their Settings ..... 559

**A Message Appears** ..... 560

**An Error Code Is Displayed** ..... 575

**If the Problem Persists** ..... 581

# Troubleshooting

---

94WS-0E4

This chapter describes how to troubleshoot problems and answers frequently asked questions.

Select an item to check from the contents or the list below.

You can click [  ] at the top of the screen to search for the message or error code (three-digit number starting with #) that appears on the operation panel, and check how to troubleshoot problems.

## ■ Frequently Asked Questions

- ▶ **Lost Department ID or PIN for the Administrator(P. 558)**
- ▶ **Cannot Print or Copy(P. 535)**
- ▶ **Cannot Send or Receive a Fax via Optical Line(P. 552)**

## ■ Frequently Asked Questions about Operations

### **I Want to Scan an Original.**

Make preparations according to the scanned data save destination and, and then scan the original.

- ▶ **Scanning(P. 193)**

### **I Want to Forward a Received Fax.**

Configure the settings to automatically forward received faxes to a computer or other fax machine.

- ▶ **Auto Forwarding and Backing Up Received Faxes(P. 219)**

### **I Want to Send a Fax from a Computer.**

You can send a document as a fax from a computer using a fax driver.

- ▶ **Sending Faxes from a Computer (PC Faxing)(P. 225)**

### **I Want to Print on an Envelope.**

Place the envelope in the paper drawer tray while paying attention to the orientation and side of the envelope.

Then, set the paper size and type according to the placed envelope.

Next, use the print driver of the computer to set the paper size of the document and the paper size to print, and then perform printing.

- ▶ **Preparations and Orientation for Loading Envelopes(P. 135)**
- ▶ **Specifying the Paper Size and Type(P. 139)**
- ▶ **Printing from a Computer(P. 182)**

# Paper Jams

94WS-0E5

If paper jams in the machine, [Paper jammed.] appears on operation panel.

### Touch Panel Model

Press [Next], and follow the displayed instructions on how to clear the paper jam.

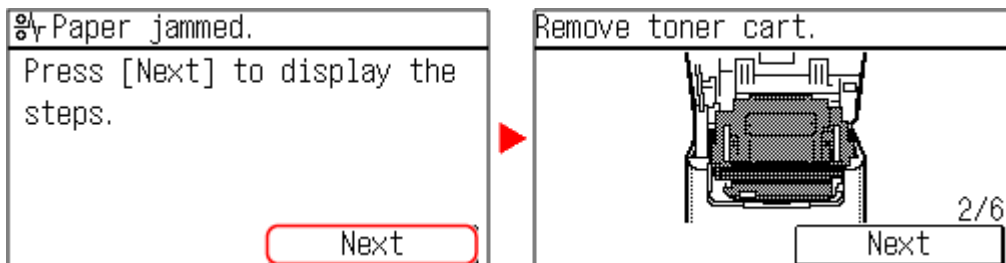

### 5 Lines LCD Model

Press , and follow the displayed instructions on how to clear the paper jam.

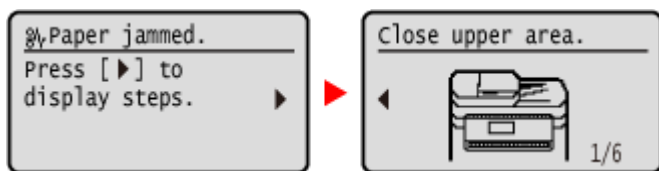

For details about clearing paper jams from various parts of the machine, see below.

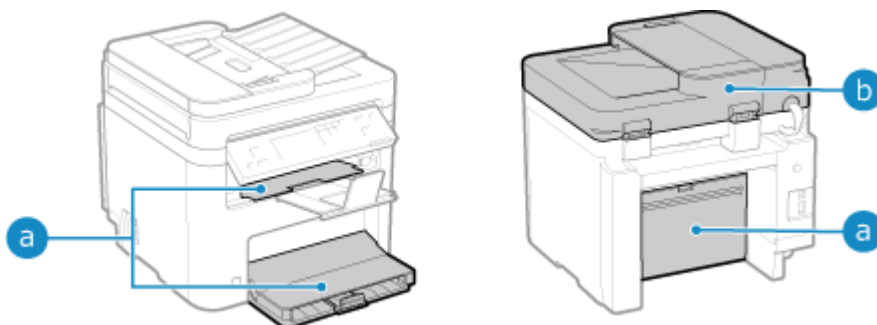

**a** Paper drawer, output tray, and rear side

 **Paper Jams in the Paper Drawer, Output Tray, and Rear Side(P. 489)**

**b** Feeder

 **Paper Jams in the Feeder(P. 493)**

## CAUTION

### Do not forcibly remove the jammed paper from the machine.

- Forcibly removing the paper may result in personal injury or damage parts of the machine. If you cannot remove the paper, contact your dealer or service representative.  **If the Problem Persists(P. 581)**

### When All Paper Jams Have Been Cleared

- Immediately remove your hands from the machine so that your clothing and hands do not get caught in the rollers.



 **IMPORTANT**

**When clearing paper jams, do not turn the power OFF.**

- Data being printed is erased when you turn the power OFF.

**When the Paper Gets Torn**

- Be sure to remove it so that no pieces remain.

# Paper Jams in the Paper Drawer, Output Tray, and Rear Side

94WS-0E6

Use the procedure below to check the paper drawer, output tray, rear side, and to remove any jammed paper. If the paper tears, be sure to remove the parts so that no pieces remain.

## 1 Lift the operation panel.

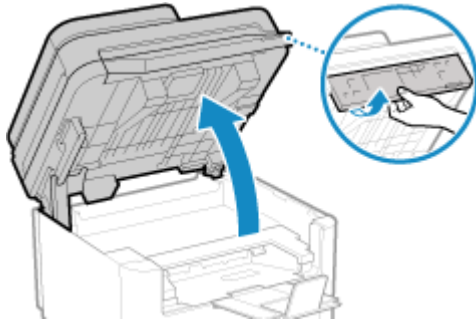

Check the following before lifting up the operation panel:

- The feeder or platen glass cover is completely closed
- There are no thick originals such as books placed on the platen glass
- \* Using excessive force to raise the operation panel could cause a fault.

## 2 Close the paper stopper before opening the toner cover.

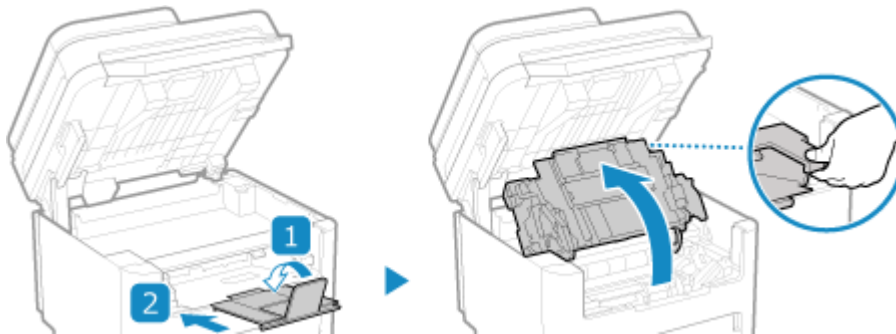

## 3 Remove the toner cartridge.

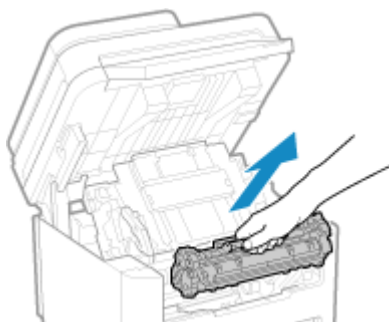

Slowly pull it out at the same angle as the slot.

## 4 Remove the paper jammed in the paper drawer.

- 1** Open the paper cover.
- 2** If other paper is loaded, remove that paper.
- 3** Gently pull out the paper.

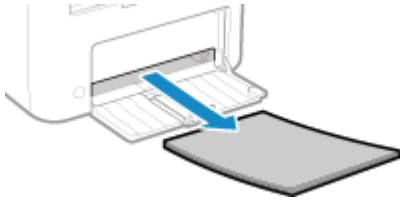

- 4** Load the paper and close the paper cover.

## **5** Remove the paper jammed inside the paper exit guide.

- 1** Pull out the transport guide.

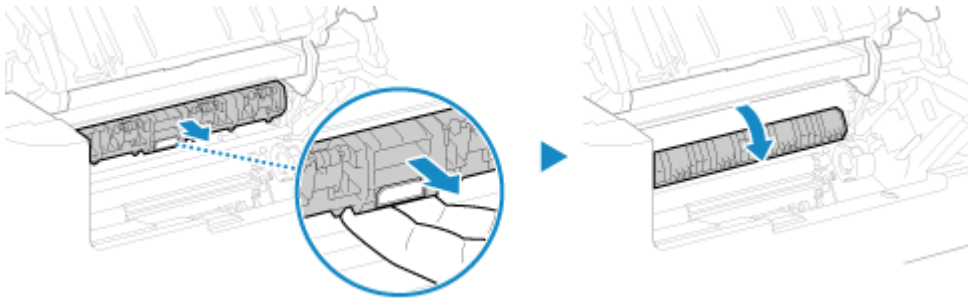

- 2** Gently pull out the paper.

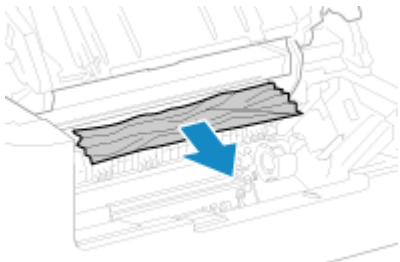

- 3** Close the paper exit guide.

## **6** Remove the paper jammed inside the machine.

- 1** Gently pull out the paper.

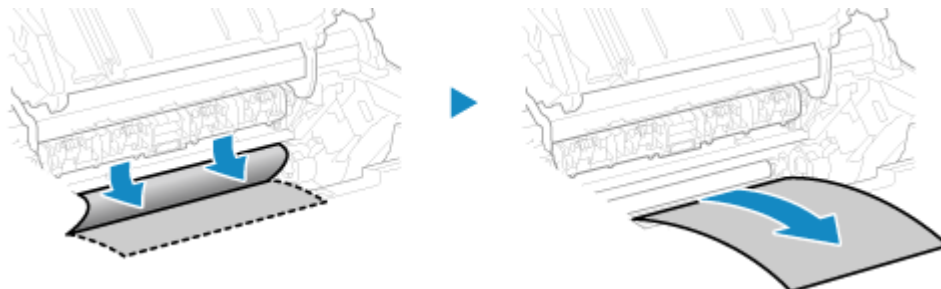

Holding both sides of the paper, pull the front edge of the paper out and downwards.

- 2** Check whether paper is jammed in the guides.

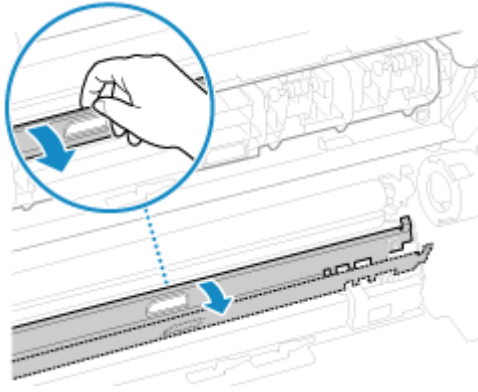

**If paper is jammed**

Open the paper cover and remove any other loaded paper. Then slowly pull out the jammed paper.

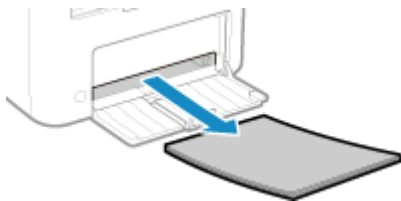

Load paper in the paper drawer and close the paper cover.

**7 Remove the paper jammed inside rear cover.**

**1** Open the rear cover.

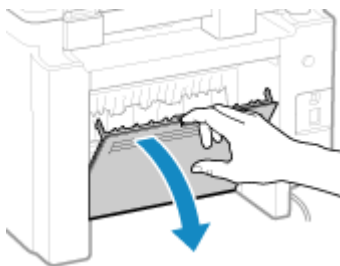

**2** Gently pull out the paper.

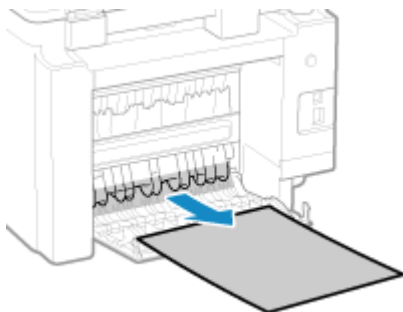

**3** Close the rear cover.

**8 Insert the toner cartridge.**

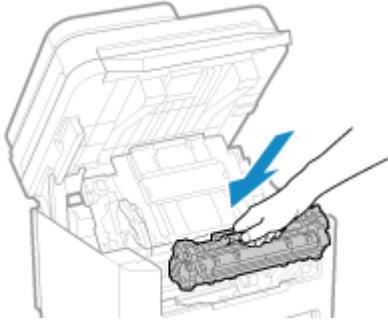

**9 Close the toner cover, and lower the operation panel.**

- ▣ The message [Paper jammed.] disappears, and printing resumes automatically.  
If printing does not resume automatically, try printing again.

## NOTE

### If Paper Jams Occur Repeatedly

- Check the status of the machine and paper. [▶ Paper Jams That Occur Repeatedly\(P. 494\)](#)

## Paper Jams in the Feeder

Remove the original jammed inside or at the rear side of the feeder. If the original tears, be sure to remove the parts so that no pieces remain.

**1** If another original is placed in the feeder, remove that original.

**2** Remove the original jammed inside the feeder.

**1** Open the feeder cover.

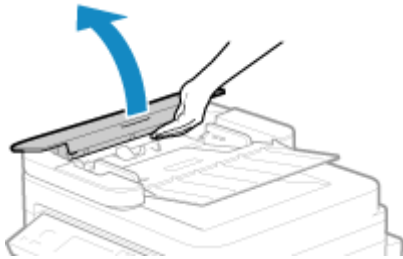

**2** Gently pull out the original.

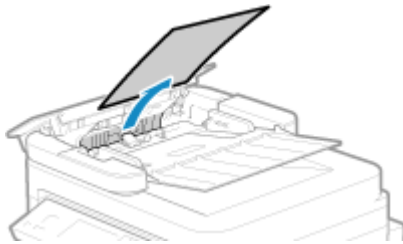

**3** Close the feeder cover.

**3** Place the original in the feeder again.

- ➡ The message [Paper jammed.] disappears, and you can scan the original.
- Jobs in which an original jammed are canceled automatically. The job does not resume even if you place the original again, so execute the job again.

### NOTE

#### If Paper Jams Occur Repeatedly

- Check the status of the machine and original. ▶ [Paper Jams That Occur Repeatedly\(P. 494\)](#)

# Paper Jams That Occur Repeatedly

94WS-0E9

Troubleshoot by checking the items below.

## Are There Paper Scraps or Foreign Objects Inside the Machine?

Remove any paper scraps or foreign objects. **▶ Paper Jams (P. 487)**

## Are You Using Appropriate Paper?

Check whether the paper in the machine is usable, and replace it with appropriate paper, as needed.

**▶ Usable Paper (P. 19)**

**▶ Loading Paper (P. 132)**

## Is Paper Loaded Correctly?

- Fan the paper thoroughly in small batches so that it is not stuck together.
- Align the edges by tapping the paper on a flat surface a few times before loading the paper. **▶ Loading Paper (P. 132)**
- Make sure the loaded paper does not exceed the load limit line ( **a** ).

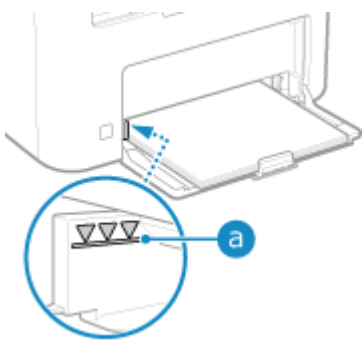

- Check that the paper guides are not too loose or too tight.

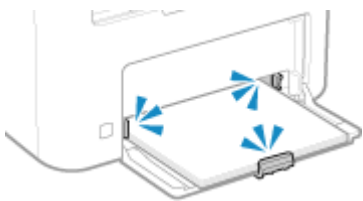

## Do Paper Jams Occur When Printing on the Back Side of Printed Paper?

Flatten the edges of the paper to thoroughly remove any curls.

\* When printing on the back side of printed paper, you can only use paper printed with this machine. Do not use paper printed with another printer or multifunction machine, as this can cause paper jams or damage the machine.







## Does This Occur When Printing Continuously?

If so, setting [Correct Paper Conveyance] to [On] may reduce the frequency of paper jams.

### Touch Panel Model

On the [Home] screen of the operation panel ▶ [Menu] ▶ [Adjustment/Maintenance] ▶ [Adjust Image Quality] ▶ [Special Processing] ▶ [Correct Paper Conveyance] ▶ [On]

### 5 Lines LCD Model

[Home] screen on the operation panel ▶ [Menu] ▶  ▶ [Adjustment/Maintenance] ▶  ▶ [Adjust Image Quality] ▶  ▶ [Special Processing] ▶  ▶ [Correct Paper Conveyance] ▶  ▶ [On] ▶ 

\* When you select [On], the printing speed may decrease.



## Problems with Printing Results

94WS-0EA

If printouts show any of the symptoms below, check how to troubleshoot the problem based on the symptom.



▶ **Toner Smudges and Splatters Appear(P. 498)**

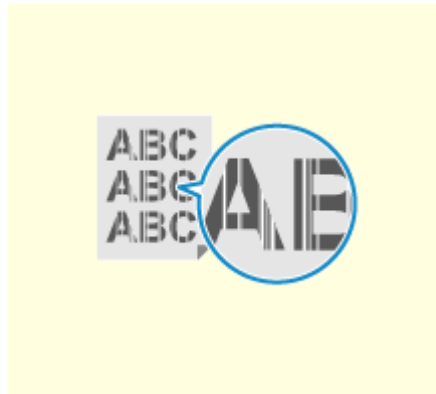

▶ **Streaks Appear(P. 500)**



▶ **Printing Is Uneven(P. 502)**

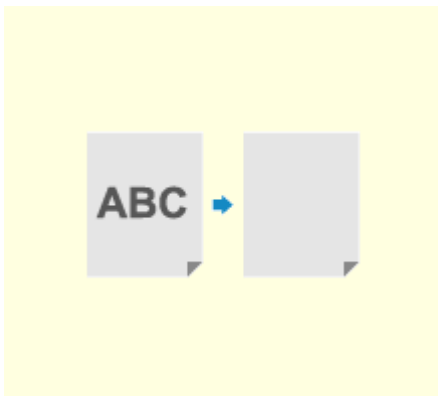

▶ **Printed Paper Is Blank(P. 504)**

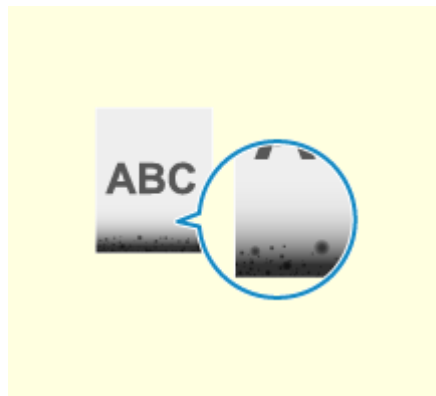

▶ **Smudge Marks Appear on the Edge of Printouts(P. 505)**



▶ **Text or Images Are Blurry(P. 506)**

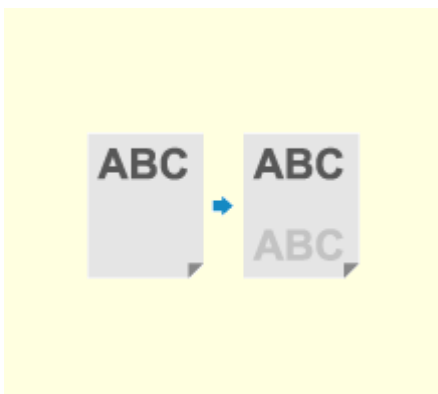

▶ **Printouts Have Ghost Images(P. 508)**



▶ **Printouts Are Faded(P. 510)**

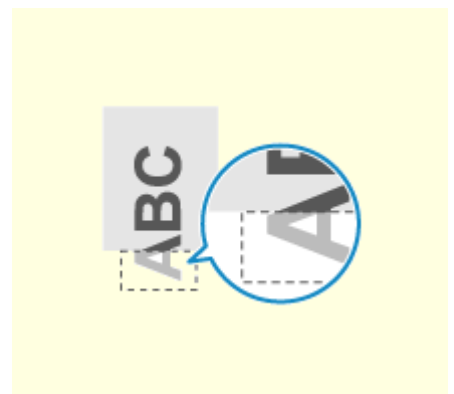

▶ **The Edge of the Page Is Not Printed(P. 512)**

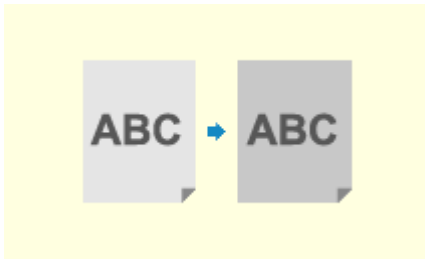

▶ **The Background Is Generally Dark(P. 513)**



▶ **White Spots Appear(P. 514)**

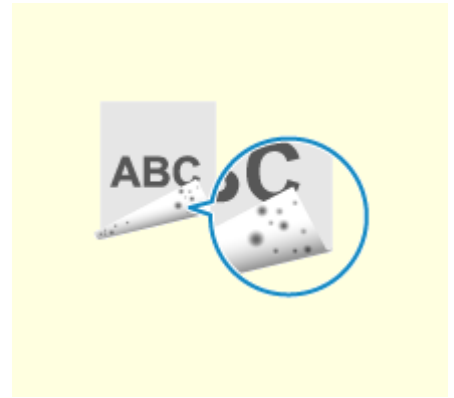

▶ **Smudge Marks Appear on the Back Side of Printouts(P. 516)**

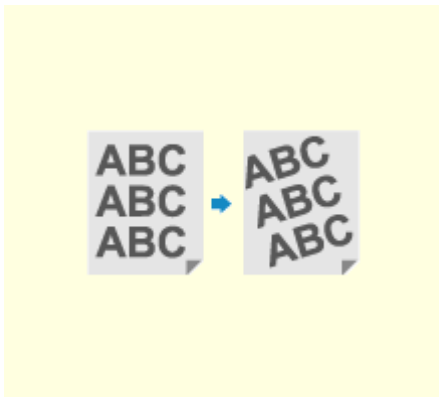

▶ **Printouts Are Skewed(P. 517)**



▶ **The Printed Barcode Cannot be Scanned(P. 518)**

# Toner Smudges and Splatters Appear

94WS-0EC

Troubleshoot by checking in the following order:

- ▶ **Step 1: Checking the Paper(P. 498)**
- ▶ **Step 2: Checking the Toner Cartridge(P. 498)**
- ▶ **Step 3: Checking the Usage Environment of the Machine(P. 498)**
- ▶ **Step 4: Checking the Maintenance Status(P. 499)**

## Step 1: Checking the Paper

### Are You Using Appropriate Paper?

Check whether the paper in the machine is usable, and replace it with appropriate paper, as needed.

- ▶ **Usable Paper(P. 19)**
- ▶ **Loading Paper(P. 132)**

## Step 2: Checking the Toner Cartridge

### Check the Remaining Amount of Toner in the Toner Cartridge.

If the remaining amount of toner in the toner cartridge is low, replace the toner cartridge.

- ▶ **Checking the Remaining Amount of Consumables(P. 477)**
- ▶ **Replacing the Toner Cartridge(P. 471)**

\* Depending on the usage condition of the machine, the actual remaining amount of toner may be lower than indicated or the parts may be deteriorated.

## Step 3: Checking the Usage Environment of the Machine

### Are You Using the Machine in an Environment with Low Humidity?

Setting [Low Humidity Mode] to [Mode 1] may solve the problem. If that does not work, try selecting [Mode 2] and then [Mode 3] in sequence.

#### Touch Panel Model

[Home] screen on the operation panel ▶ [Menu] ▶ [Adjustment/Maintenance] ▶ [Adjust Image Quality] ▶ [Special Processing] ▶ [Low Humidity Mode] ▶ select the mode.

#### 5 Lines LCD Model

[Home] screen on the operation panel ▶ [Menu] ▶ **OK** ▶ [Adjustment/Maintenance] ▶ **OK** ▶ [Adjust Image Quality] ▶ **OK** ▶ [Special Processing] ▶ **OK** ▶ [Low Humidity Mode] ▶ **OK** ▶ select the mode.

\* Enabling this setting may reduce the density or create fading in a humid environment.

## Step 4: Checking the Maintenance Status

### **Have You Cleaned the Fixing Assembly?**

---

These symptoms may occur when the fixing assembly is dirty. In this case, clean the fixing assembly. ▶  
**Cleaning the Fixing Assembly(P. 468)**

# Streaks Appear

94WS-0EE

Troubleshoot by checking in the following order:

- ▶ **Step 1: Checking the Paper(P. 500)**
- ▶ **Step 2: Checking the Platen Glass(P. 500)**
- ▶ **Step 3: Checking the Toner Cartridge(P. 500)**
- ▶ **Step 4: Checking the Usage Environment of the Machine(P. 500)**
- ▶ **Step 5: Checking the Maintenance Status(P. 501)**

## Step 1: Checking the Paper

### Are You Using Appropriate Paper?

Check whether the paper in the machine is usable, and replace it with appropriate paper, as needed.

- ▶ **Usable Paper(P. 19)**
- ▶ **Loading Paper(P. 132)**

## Step 2: Checking the Platen Glass

### Is the Platen Glass Dirty?

Clean the platen glass, feeder, and underside of the platen glass cover if they are dirty.

- ▶ **Cleaning the Platen Glass(P. 465)**
- ▶ **Cleaning the Feeder(P. 466)**

## Step 3: Checking the Toner Cartridge

### Check the Remaining Amount of Toner in the Toner Cartridge.

If the remaining amount of toner in the toner cartridge is low, replace the toner cartridge.

- ▶ **Checking the Remaining Amount of Consumables(P. 477)**
- ▶ **Replacing the Toner Cartridge(P. 471)**

\* Depending on the usage condition of the machine, the actual remaining amount of toner may be lower than indicated or the parts may be deteriorated.

## Step 4: Checking the Usage Environment of the Machine

### Are You Using the Machine in an Environment with Sudden Temperature Changes?

Sudden temperature changes can create condensation, which can result in faded or blurry images and text. Continuing to use the machine under these conditions may result in paper jams, printing defects, faults, or other problems. Allow the machine to adjust to the ambient temperature and humidity for at least 2 hours before use.

### Is the Machine Installed in a Location Subject to Strong Wind Such as from an Air Conditioner?

If so, adjust the air direction and volume of the air conditioner.  
If that does not work, setting [Switch Paper Feed Method] to [Print Side Priority] may improve the problem.

**Touch Panel Model**

[Home] on the operation panel ▶ [Menu] ▶ [Function Settings] ▶ [Common] ▶ [Paper Feed Settings] ▶ [Switch Paper Feed Method] ▶ [Drawer 1] ▶ [Print Side Priority]

#### 5 Lines LCD Model

[Home] on the operation panel ▶ [Menu] ▶ **OK** ▶ [Function Settings] ▶ **OK** ▶ [Common] ▶ **OK** ▶ [Paper Feed Settings] ▶ **OK** ▶ [Switch Paper Feed Method] ▶ **OK** ▶ [Drawer 1] ▶ **OK** ▶ [Print Side Priority] ▶ **OK**

\* When you select [Print Side Priority], the printing speed for 1-Sided printing will decrease.

### Try using Output Adjustment Mode

Setting [Output Adjustment Mode] to [On] may solve the problem.

#### Touch Panel Model

[Home] on the operation panel ▶ [Menu] ▶ [Function Settings] ▶ [Printer] ▶ [Printer Settings] ▶ [Print Quality] ▶ [Output Adjustment Mode] ▶ [On]

#### 5 Lines LCD Model

[Home] on the operation panel ▶ [Menu] ▶ **OK** ▶ [Function Settings] ▶ **OK** ▶ [Printer] ▶ **OK** ▶ [Printer Settings] ▶ **OK** ▶ [Print Quality] ▶ **OK** ▶ [Output Adjustment Mode] ▶ **OK** ▶ [On]

\* When you select [On], the printing speed may decrease.

## Step 5: Checking the Maintenance Status

### Have You Cleaned the Fixing Assembly?

These symptoms may occur when the fixing assembly is dirty. In this case, clean the fixing assembly. ▶ **Cleaning the Fixing Assembly(P. 468)**

# Printing Is Uneven

94WS-0EF

Troubleshoot by checking in the following order:

- ▶ **Step 1: Checking the Paper(P. 502)**
- ▶ **Step 2: Checking the Toner Cartridge(P. 502)**
- ▶ **Step 3: Checking the Usage Environment of the Machine(P. 502)**

## Step 1: Checking the Paper

### Are You Using Appropriate Paper?

Check whether the paper in the machine is usable, and replace it with appropriate paper, as needed.

- ▶ **Usable Paper(P. 19)**
- ▶ **Loading Paper(P. 132)**

## Step 2: Checking the Toner Cartridge

### Check the Remaining Amount of Toner in the Toner Cartridge.

If the remaining amount of toner in the toner cartridge is low, replace the toner cartridge.

- ▶ **Checking the Remaining Amount of Consumables(P. 477)**
- ▶ **Replacing the Toner Cartridge(P. 471)**

\* Depending on the usage condition of the machine, the actual remaining amount of toner may be lower than indicated or the parts may be deteriorated.

## Step 3: Checking the Usage Environment of the Machine

### Are You Using the Machine in a Humid Environment?

Setting [High Humidity Mode] to [On] may solve the problem.

#### Touch Panel Model

[Home] screen on the operation panel ▶ [Menu] ▶ [Adjustment/Maintenance] ▶ [Adjust Image Quality] ▶ [Special Processing] ▶ [High Humidity Mode] ▶ [On]

#### 5 Lines LCD Model

[Home] screen on the operation panel ▶ [Menu] ▶ **OK** ▶ [Adjustment/Maintenance] ▶ **OK** ▶ [Adjust Image Quality] ▶ **OK** ▶ [Special Processing] ▶ **OK** ▶ [High Humidity Mode] ▶ **OK** ▶ [On] ▶ **OK**

\* Setting this to [On] may blur images and text in an environment with low humidity.

### Are You Using the Machine in an Environment with Sudden Temperature Changes?

Sudden temperature changes can create condensation, which can result in faded or blurry images and text. Continuing to use the machine under these conditions may result in paper jams, printing defects, faults, or other problems. Allow the machine to adjust to the ambient temperature and humidity for at least 2 hours before use.

## Is the Machine Installed in a Location Subject to Strong Wind Such as from an Air Conditioner?

If so, adjust the air direction and volume of the air conditioner.

If that does not work, setting [Switch Paper Feed Method] to [Print Side Priority] may improve the problem.

### Touch Panel Model

[Home] on the operation panel ▶ [Menu] ▶ [Function Settings] ▶ [Common] ▶ [Paper Feed Settings] ▶ [Switch Paper Feed Method] ▶ [Drawer 1] ▶ [Print Side Priority]

### 5 Lines LCD Model

[Home] on the operation panel ▶ [Menu] ▶ **OK** ▶ [Function Settings] ▶ **OK** ▶ [Common] ▶ **OK** ▶ [Paper Feed Settings] ▶ **OK** ▶ [Switch Paper Feed Method] ▶ **OK** ▶ [Drawer 1] ▶ [Print Side Priority] ▶ **OK**

\* When you select [Print Side Priority], the printing speed for 1-Sided printing will decrease.



# Printed Paper Is Blank

---

94WS-0EH

Troubleshoot by checking the following steps:

## Is Original Placed Correctly?

---

Place the original correctly while paying attention to the orientation of the side to be scanned.

### When Placing It on the Platen Glass

Place the original with the side to be scanned face down. ▶ [Placing Originals on the Platen Glass\(P. 129\)](#)

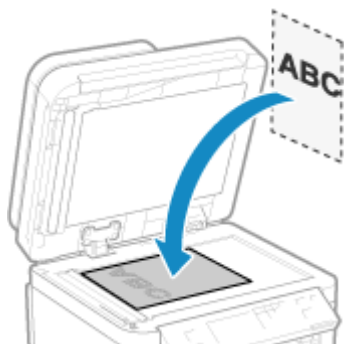

### When Placing Originals in the Feeder

Place the original with the side to be scanned face up. ▶ [Placing Originals in the Feeder\(P. 130\)](#)



# Smudge Marks Appear on the Edge of Printouts

---

94WS-0EJ

Troubleshoot by checking in the following order:

## Are You Using Appropriate Paper?

---

- Check whether the paper in the machine is usable, and replace it with appropriate paper, as needed.
  - ▶ **Usable Paper(P. 19)**
  - ▶ **Loading Paper(P. 132)**

## Are You Printing to the Edge of the Paper Without Margins?

---

This symptom may occur when the margin is set to none in the printer driver. To print with this machine, a margin of 5 mm (15 mm at the top and bottom and 10 mm on the left and right sides) is required.

On the [Printing preferences] screen of the printer driver, configure the following setting to provide a margin.

[Finishing] tab ▶ [Advanced Settings] ▶ [Expand Print Region and Print] ▶ [Off]

## Have You Cleaned the Fixing Assembly?

---

These symptoms may occur when the fixing assembly is dirty. In this case, clean the fixing assembly. ▶ **Cleaning the Fixing Assembly(P. 468)**

# Text or Images Are Blurry

94WS-0EK

Troubleshoot by checking the following steps:

- ▶ **Step 1: Checking the Paper(P. 506)**
- ▶ **Step 2: Checking the Usage Environment of the Machine(P. 506)**
- ▶ **Step 3: Checking the Special Processing Settings(P. 507)**

## Step 1: Checking the Paper

### Are You Using Appropriate Paper?

Check whether the paper in the machine is usable, and replace it with appropriate paper, as needed.

- ▶ **Usable Paper(P. 19)**
- ▶ **Loading Paper(P. 132)**

## Step 2: Checking the Usage Environment of the Machine

### Are You Using the Machine in an Environment with Low Humidity?

Setting [Low Humidity Mode] to [Mode 1] may solve the problem. If that does not work, try selecting [Mode 2] and then [Mode 3] in sequence.

#### Touch Panel Model

[Home] screen on the operation panel ▶ [Menu] ▶ [Adjustment/Maintenance] ▶ [Adjust Image Quality] ▶ [Special Processing] ▶ [Low Humidity Mode] ▶ select the mode

#### 5 Lines LCD Model

[Home] screen on the operation panel ▶ [Menu] ▶ **OK** ▶ [Adjustment/Maintenance] ▶ **OK** ▶ [Adjust Image Quality] ▶ **OK** ▶ [Special Processing] ▶ **OK** ▶ [Low Humidity Mode] ▶ **OK** ▶ select the mode ▶ **OK**

\* Enabling this setting may reduce the density or create fading in a humid environment.

### Are You Using the Machine in a Humid Environment?

Setting [High Humidity Mode] to [On] may solve the problem.

#### Touch Panel Model

[Home] screen on the operation panel ▶ [Menu] ▶ [Adjustment/Maintenance] ▶ [Adjust Image Quality] ▶ [Special Processing] ▶ [High Humidity Mode] ▶ [On]

#### 5 Lines LCD Model

[Home] screen on the operation panel ▶ [Menu] ▶ **OK** ▶ [Adjustment/Maintenance] ▶ **OK** ▶ [Adjust Image Quality] ▶ **OK** ▶ [Special Processing] ▶ **OK** ▶ [High Humidity Mode] ▶ **OK** ▶ [On] ▶ **OK**

\* Setting this to [On] may blur images and text in an environment with low humidity.

### Are You Using the Machine in an Environment with Sudden Temperature Changes?

Sudden temperature changes can create condensation, which can result in faded or blurry images and text. Continuing to use the machine under these conditions may result in paper jams, printing defects, faults, or

other problems. Allow the machine to adjust to the ambient temperature and humidity for at least 2 hours before use.

## Step 3: Checking the Special Processing Settings

### Is [Correct Blurry Image] enabled?

Setting [Correct Blurry Image] to [Mode 1] may improve the print results. If that does not work, select [Mode 2].

#### Touch Panel Model

[Home] screen on the operation panel ▶ [Menu] ▶ [Adjustment/Maintenance] ▶ [Adjust Image Quality] ▶ [Special Processing] ▶ [Correct Blurry Image] ▶ [Mode 1] or [Mode 2]

#### 5 Lines LCD Model

[Home] screen on the operation panel ▶ [Menu] ▶ **OK** ▶ [Adjustment/Maintenance] ▶ **OK** ▶ [Adjust Image Quality] ▶ **OK** ▶ [Special Processing] ▶ **OK** ▶ [Correct Blurry Image] ▶ **OK** ▶ [Mode 1] or [Mode 2] ▶ **OK**

# Printouts Have Ghost Images

94WS-0EL

Troubleshoot by checking the following steps:

- ▶ **Step 1: Checking the Paper and Toner Cartridge(P. 508)**
- ▶ **Step 2: Checking the Occurrence of Ghost Images(P. 508)**
- ▶ **Step 3: Checking the Maintenance Status of the Machine(P. 509)**
- ▶ **Step 4: Checking the Special Processing Setting(P. 509)**

## Step 1: Checking the Paper and Toner Cartridge

### Are You Using Appropriate Paper?

Check whether the paper in the machine is usable, and replace it with appropriate paper, as needed.

- ▶ **Usable Paper(P. 19)**
- ▶ **Loading Paper(P. 132)**

### Have the Toner Cartridge Reached the End of Their Lifetime?

Parts inside the toner cartridge may have deteriorated. If this symptom occurs, it is recommended to replace the toner cartridge regardless of the remaining amount of toner or messages displayed. ▶ **Replacing the Toner Cartridge(P. 471)**

## Step 2: Checking the Occurrence of Ghost Images

### Do Ghost Images Appear in Unprinted Sections?

If you print on small-sized paper and then continue printing on a larger sized paper, ghost images may appear in the unprinted sections of the paper. In this event, setting [Reduce Ghosting 1] to [On] may improve the print results.

#### Touch Panel Model

[Home] screen on the operation panel ▶ [Menu] ▶ [Adjustment/Maintenance] ▶ [Adjust Image Quality] ▶ [Special Processing] ▶ [Reduce Ghosting 1] ▶ [On]

#### 5 Lines LCD Model

[Home] screen on the operation panel ▶ [Menu] ▶ **OK** ▶ [Adjustment/Maintenance] ▶ **OK** ▶ [Adjust Image Quality] ▶ **OK** ▶ [Special Processing] ▶ **OK** ▶ [Reduce Ghosting 1] ▶ **OK** ▶ [On] ▶ **OK**

\* When you select [On], the printing speed may decrease.

### Do Ghost Images Appear Within the Same Page?

Setting [Transfer Adjust. Mode] to [Mode 1] may solve the problem. If that does not work, select [Mode 2].

#### Touch Panel Model

[Home] screen on the operation panel ▶ [Menu] ▶ [Adjustment/Maintenance] ▶ [Adjust Image Quality] ▶ [Special Processing] ▶ [Transfer Adjust. Mode] ▶ [Mode 1] or [Mode 2]

#### 5 Lines LCD Model

[Home] screen on the operation panel ▶ [Menu] ▶ **OK** ▶ [Adjustment/Maintenance] ▶ **OK** ▶ [Adjust Image Quality] ▶ **OK** ▶ [Special Processing] ▶ **OK** ▶ [Transfer Adjust. Mode] ▶ **OK** ▶ [Mode 1] or [Mode 2] ▶ **OK**

\* When this setting is enabled, the print density may vary in an environment with low- humidity.

## Step 3: Checking the Maintenance Status of the Machine

### Have You Cleaned the Fixing Assembly?

These symptoms may occur when the fixing assembly is dirty. In this case, clean the fixing assembly. ▶ **Cleaning the Fixing Assembly(P. 468)**

## Step 4: Checking the Special Processing Setting

### Is [Reduce Toner Flaking] Enabled?

If so, setting [Reduce Toner Flaking] to [Off] may improve the problem.

#### Touch Panel Model

[Home] screen on the operation panel ▶ [Menu] ▶ [Adjustment/Maintenance] ▶ [Adjust Image Quality] ▶ [Special Processing] ▶ [Reduce Toner Flaking] ▶ [Off]

#### 5 Lines LCD Model

[Home] screen on the operation panel ▶ [Menu] ▶ **OK** ▶ [Adjustment/Maintenance] ▶ **OK** ▶ [Adjust Image Quality] ▶ **OK** ▶ [Special Processing] ▶ **OK** ▶ [Reduce Toner Flaking] ▶ **OK** ▶ [Off] ▶ **OK**

# Printouts Are Faded

94WS-0ER

Troubleshoot by checking the following steps:

- ▶ **Step 1: Checking the Paper and Toner Cartridge(P. 510)**
- ▶ **Step 2: Checking the Usage Environment of the Machine(P. 510)**
- ▶ **Step 3: Checking the Special Processing Setting(P. 511)**

## Step 1: Checking the Paper and Toner Cartridge

### Are You Using Appropriate Paper?

- Check whether the paper in the machine is usable, and replace it with appropriate paper, as needed.
  - ▶ **Usable Paper(P. 19)**
  - ▶ **Loading Paper(P. 132)**
- Set the paper size and type correctly according to the loaded paper. ▶ **Specifying the Paper Size and Type(P. 139)**

### Does the Printed Toner Flake Off Depending on Paper Type or Usage Environment?

If so, setting [Reduce Toner Flaking] to [Mode 1] may improve the problem. If that does not work, select [Mode 2].

#### Touch Panel Model

[Home] screen on the operation panel ▶ [Menu] ▶ [Adjustment/Maintenance] ▶ [Adjust Image Quality] ▶ [Special Processing] ▶ [Reduce Toner Flaking] ▶ [Mode 1] or [Mode 2]

#### 5 Lines LCD Model

[Home] screen on the operation panel ▶ [Menu] ▶ **OK** ▶ [Adjustment/Maintenance] ▶ **OK** ▶ [Adjust Image Quality] ▶ **OK** ▶ [Special Processing] ▶ **OK** ▶ [Reduce Toner Flaking] ▶ **OK** ▶ [Mode 1] or [Mode 2] ▶ **OK**

\* When this setting is enabled, ghost images may appear in unprinted areas.

### Have the Toner Cartridge Reached the End of Their Lifetime?

Parts inside the toner cartridge may have deteriorated. If this symptom occurs, it is recommended to replace the toner cartridge regardless of the remaining amount of toner or messages displayed. ▶ **Replacing the Toner Cartridge(P. 471)**

\* Depending on the usage condition of the machine, the actual remaining amount of toner may be lower than indicated or the parts may be deteriorated.

## Step 2: Checking the Usage Environment of the Machine

### Are You Using the Machine in an Environment with Sudden Temperature Changes?

Sudden temperature changes can create condensation, which can result in faded or blurry images and text. Continuing to use the machine under these conditions may result in paper jams, printing defects, faults, or other problems. Allow the machine to adjust to the ambient temperature and humidity for at least 2 hours before use.

## Is the Machine Installed in a Location Subject to Strong Wind Such as from an Air Conditioner?

If so, adjust the air direction and volume of the air conditioner.  
If that does not work, setting [Switch Paper Feed Method] to [Print Side Priority] may improve the problem.

### Touch Panel Model

[Home] on the operation panel ▶ [Menu] ▶ [Function Settings] ▶ [Common] ▶ [Paper Feed Settings] ▶ [Switch Paper Feed Method] ▶ [Drawer 1] ▶ [Print Side Priority]

### 5 Lines LCD Model

[Home] on the operation panel ▶ [Menu] ▶ **OK** ▶ [Function Settings] ▶ **OK** ▶ [Common] ▶ **OK** ▶ [Paper Feed Settings] ▶ **OK** ▶ [Switch Paper Feed Method] ▶ **OK** ▶ [Drawer 1] ▶ **OK** ▶ [Print Side Priority] ▶ **OK**

\* When you select [Print Side Priority], the printing speed for 1-Sided printing will decrease.

## Step 3: Checking the Special Processing Setting

### Is [Special Processing] Enabled?

If so, setting [Special Processing] below to [Off] may improve the problem. ▶**[Special Processing](P. 408)**

- [Reduce Ppr. Sticking at Output]
- [Envelope Flap Closing Prevention]
- [Paper Curl Correction]

### Touch Panel Model

[Home] screen on the operation panel ▶ [Menu] ▶ [Adjustment/Maintenance] ▶ [Adjust Image Quality] ▶ [Special Processing]

### 5 Lines LCD Model

[Home] screen on the operation panel ▶ [Menu] ▶ **OK** ▶ [Adjustment/Maintenance] ▶ **OK** ▶ [Adjust Image Quality] ▶ **OK** ▶ [Special Processing] ▶ **OK**



# The Edge of the Page Is Not Printed

---

94WS-0ES

Troubleshoot by checking in the following order:

## Are You Using Appropriate Paper?

---

Check whether the paper in the machine is usable, and replace it with appropriate paper, as needed.

▶ **Usable Paper(P. 19)**

▶ **Loading Paper(P. 132)**

## Are the Paper Guides Correctly Aligned with the Paper?

---

Paper guides that are aligned but too loose or too tight can cause part of the page to not be printed. Check the paper guides, and align them with the width of the paper. ▶ **Loading Paper(P. 132)**

## Are You Printing to the Edge of the Paper Without Margins?

---

This symptom may occur when the margin is set to none in the printer driver. To print with this machine, a margin of 5 mm (15 mm at the top and bottom and 10 mm on the left and right sides) is required.

On the [Printing preferences] screen of the printer driver, configure the following setting to provide a margin.

[Finishing] tab ▶ [Advanced Settings] ▶ [Expand Print Region and Print] ▶ [Off]

## The Background Is Generally Dark

94WS-0EU

Troubleshoot by checking in the following order:

### Are White Areas Generally Dark?

Setting [Prevent Fogging] to [On] may solve the problem.

#### Touch Panel Model

[Home] screen on the operation panel ▶ [Menu] ▶ [Adjustment/Maintenance] ▶ [Adjust Image Quality] ▶ [Special Processing] ▶ [Prevent Fogging] ▶ [On]

#### 5 Lines LCD Model

[Home] screen on the operation panel ▶ [Menu] ▶ **OK** ▶ [Adjustment/Maintenance] ▶ **OK** ▶ [Adjust Image Quality] ▶ **OK** ▶ [Special Processing] ▶ **OK** ▶ [Prevent Fogging] ▶ [On] ▶ **OK**

\* When you select [On], the print density may decrease.

### Check the Remaining Amount of Toner in the Toner Cartridge.

If the remaining amount of toner in the toner cartridge is low, replace the toner cartridge.

▶ **Checking the Remaining Amount of Consumables(P. 477)**

▶ **Replacing the Toner Cartridge(P. 471)**

\* Depending on the usage condition of the machine, the actual remaining amount of toner may be lower than indicated or the parts maybe deteriorated.

# White Spots Appear

94WS-0EW

Troubleshoot by checking the following steps:

- ▶ **Step 1: Checking the Paper(P. 514)**
- ▶ **Step 2: Checking the Toner Cartridge(P. 514)**
- ▶ **Step 3: Checking the Occurrence of White Spots(P. 514)**
- ▶ **Step 4: Checking the Usage Environment of the Machine(P. 515)**
- ▶ **Step 5: Checking the Maintenance Status(P. 515)**

## Step 1: Checking the Paper

### Are You Using Appropriate Paper?

Check whether the paper in the machine is usable, and replace it with appropriate paper, as needed.

- ▶ **Usable Paper(P. 19)**
- ▶ **Loading Paper(P. 132)**

### Are You Using Paper That Has Absorbed Moisture?

Check the precautions, and replace the paper with dry paper.

- ▶ **Precautions When Handling Paper(P. 22)**
- ▶ **Loading Paper(P. 132)**

## Step 2: Checking the Toner Cartridge

### Check the Remaining Amount of Toner in the Toner Cartridge.

If the remaining amount of toner in the toner cartridge is low, replace the toner cartridge.

- ▶ **Checking the Remaining Amount of Consumables(P. 477)**
- ▶ **Replacing the Toner Cartridge(P. 471)**

\* Depending on the usage condition of the machine, the actual remaining amount of toner may be lower than indicated or the parts may be deteriorated.

## Step 3: Checking the Occurrence of White Spots

### Are Dark Characters and Lines Printed Hollowed Out?

Setting [Transfer Adjust. Mode] to [Mode 1] may solve the problem. If that does not work, select [Mode 2].

#### Touch Panel Model

[Home] screen on the operation panel ▶ [Menu] ▶ [Adjustment/Maintenance] ▶ [Adjust Image Quality] ▶ [Special Processing] ▶ [Transfer Adjustment Mode] ▶ [Mode 1] or [Mode 2]

#### 5 Lines LCD Model

[Home] screen on the operation panel ▶ [Menu] ▶ **OK** ▶ [Adjustment/Maintenance] ▶ **OK** ▶ [Adjust Image Quality] ▶ **OK** ▶ [Special Processing] ▶ **OK** ▶ [Transfer Adjustment Mode] ▶ **OK** ▶ [Mode 1] or [Mode 2] ▶ **OK**

\* When this setting is enabled, the print density may vary in an environment with low- humidity.

## Step 4: Checking the Usage Environment of the Machine

### Does the Printed Toner Flake Off Depending on Paper Type or Usage Environment?

If so, setting [Reduce Toner Flaking] to [Mode 1] may improve the problem. If that does not work, select [Mode 2].

#### Touch Panel Model

[Home] screen on the operation panel ▶ [Menu] ▶ [Adjustment/Maintenance] ▶ [Adjust Image Quality] ▶ [Special Processing] ▶ [Reduce Toner Flaking] ▶ [Mode 1] or [Mode 2]

#### 5 Lines LCD Model

[Home] screen on the operation panel ▶ [Menu] ▶ **OK** ▶ [Adjustment/Maintenance] ▶ **OK** ▶ [Adjust Image Quality] ▶ **OK** ▶ [Special Processing] ▶ **OK** ▶ [Reduce Toner Flaking] ▶ **OK** ▶ [Mode 1] or [Mode 2] ▶ **OK**

\* When this setting is enabled, ghost images may appear in unprinted areas.

### Are You Using Very Dusty Paper?

Setting [Talc Paper Mode] to [On] may solve the problem.

#### Touch Panel Model

[Home] screen on the operation panel ▶ [Menu] ▶ [Adjustment/Maintenance] ▶ [Adjust Image Quality] ▶ [Special Processing] ▶ [Talc Paper Mode] ▶ [On]

#### 5 Lines LCD Model

[Home] screen on the operation panel ▶ [Menu] ▶ **OK** ▶ [Adjustment/Maintenance] ▶ **OK** ▶ [Adjust Image Quality] ▶ **OK** ▶ [Special Processing] ▶ **OK** ▶ [Talc Paper Mode] ▶ **OK** ▶ [On] ▶ **OK**

\* Specifying [On] in this setting may lead to changes in the image quality.

### Are You Using the Machine in an Environment with Sudden Temperature Changes?

Sudden temperature changes can create condensation, which can result in faded or blurry images and text. Continuing to use the machine under these conditions may result in paper jams, printing defects, faults, or other problems. Allow the machine to adjust to the ambient temperature and humidity for at least 2 hours before use.

## Step 5: Checking the Maintenance Status

### Have You Cleaned the Drum?

These symptoms may occur when the drum is dirty. In this case, clean the drum. ▶ **Cleaning the Drum(P. 469)**

## Smudge Marks Appear on the Back Side of Printouts

---

94WS-0EX

Troubleshoot by checking in the following order:

### **Are You Using Paper That Is Smaller Than the Size of the Print Data?**

---

Replace with paper that is the same size as the print data. ▶ **Loading Paper(P. 132)**

### **Have You Cleaned the Fixing Assembly?**

---

These symptoms may occur when the fixing assembly is dirty. In this case, clean the fixing assembly. ▶ **Cleaning the Fixing Assembly(P. 468)**

## Printouts Are Skewed

---

94WS-0EY

This symptom may occur when the paper guides are aligned but too loose or too tight. Check the paper guides, and align them with the width of the paper. [▶ Loading Paper \(P. 132\)](#)

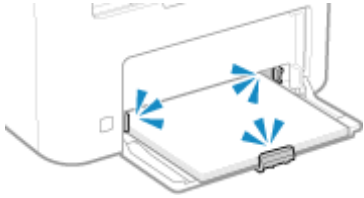

# The Printed Barcode Cannot be Scanned

---

94WS-0J8

Troubleshoot by checking in the following order:

## Are You Using a Very Small Barcode or One With Thick Lines?

---

- Enlarge the barcode.
- If the barcode lines are perpendicular to the output feed direction, rotate the image 90° so that the lines are parallel.

## Try using Barcode Adjustment Mode

---

Setting [Barcode Adjustment Mode] to [Mode 1] in the printer driver may solve the problem. If that does not work, try selecting [Mode 2] and then [Mode 3] in sequence.

- Specify the settings below in the [Printing preferences] screen of the printer driver.

[Finishing] tab ▶ [Advanced Settings] ▶ [Barcode Adjustment Mode] ▶ select the mode

\* When this setting is enabled, the print density may decrease.

- If setting [Barcode Adjustment Mode] to [Mode 3] does not work, changing the [Printer Density] may solve the problem. ▶ **[Printer Density](P. 407)**

## Paper and Paper Feeding Problems

---

94WS-0F0

Check how to troubleshoot the problem based on the symptom.

- ▶ **Paper Creases(P. 520)**
- ▶ **Paper Curls(P. 521)**
- ▶ **Paper Is Not Fed or Two or More Sheets Are Fed Together(P. 522)**
- ▶ **Printed Paper Sticks Together(P. 523)**



## Paper Creases

94WS-0F1

Troubleshoot by checking the items below.

### Is Paper Loaded Correctly?

- Make sure the loaded paper does not exceed the load limit line (a).

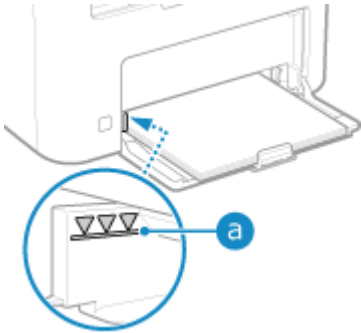

- Check that the paper guides are aligned with the markings and are not too loose or too tight.

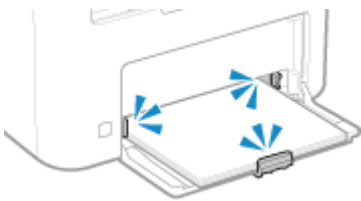

### Are You Using Paper That Has Absorbed Moisture?

Check the precautions, and replace the paper with dry paper.

- ▶ **Precautions When Handling Paper**(P. 22)
- ▶ **Loading Paper**(P. 132)

### Are You Using Appropriate Paper?

Check whether the paper in the machine is usable, and replace it with appropriate paper, as needed.

- ▶ **Usable Paper**(P. 19)
- ▶ **Loading Paper**(P. 132)

# Paper Curls

94WS-0F2

Troubleshoot by checking the items below.

## Are You Using Appropriate Paper?

- Check whether the paper in the machine is usable, and replace it with appropriate paper, as needed.
  - ▶ **Usable Paper(P. 19)**
  - ▶ **Loading Paper(P. 132)**
- Set the paper size and type correctly according to the loaded paper. ▶ **Specifying the Paper Size and Type(P. 139)**
- Setting [Paper Curl Correction] to [On] may improve the problem.

### Touch Panel Model

[Home] screen on the operation panel ▶ [Menu] ▶ [Adjustment/Maintenance] ▶ [Adjust Image Quality] ▶ [Special Processing] ▶ [Special Paper Processing] ▶ [Paper Curl Correction] ▶ [On]

### 5 Lines LCD Model

[Home] screen on the operation panel ▶ [Menu] ▶ **OK** ▶ [Adjustment/Maintenance] ▶ **OK** ▶ [Adjust Image Quality] ▶ **OK** ▶ [Special Processing] ▶ **OK** ▶ [Special Paper Processing] ▶ **OK** ▶ [Paper Curl Correction] ▶ **OK** ▶ [On] ▶ **OK**

\* When you select [On], this may result in faded printouts.

- Setting [Switch Paper Feed Method] to [Print Side Priority] may improve the problem.

### Touch Panel Model

[Home] on the operation panel ▶ [Menu] ▶ [Function Settings] ▶ [Common] ▶ [Paper Feed Settings] ▶ [Switch Paper Feed Method] ▶ [Drawer 1] ▶ [Print Side Priority]

### 5 Lines LCD Model

[Home] on the operation panel ▶ [Menu] ▶ **OK** ▶ [Function Settings] ▶ **OK** ▶ [Common] ▶ **OK** ▶ [Paper Feed Settings] ▶ **OK** ▶ [Switch Paper Feed Method] ▶ **OK** ▶ [Drawer 1] ▶ **OK** ▶ [Print Side Priority] ▶ **OK**

\* When you select [Print Side Priority], the printing speed for 1-Sided printing will decrease.

- Load the paper with the side to be printed (paper front and back) reversed.
  - \* In rare cases, the symptom may worsen depending on the paper used. In this case, print on the original side of the paper.

## Are You Using Paper That Has Absorbed Moisture?

Try the following in the order below:

- Check the precautions, and replace the paper with dry paper.
  - ▶ **Precautions When Handling Paper(P. 22)**
  - ▶ **Loading Paper(P. 132)**
- Change the paper type setting to a thinner paper. ▶ **Specifying the Paper Size and Type(P. 139)**

# Paper Is Not Fed or Two or More Sheets Are Fed Together

---

94WS-0F3

Troubleshoot by checking the items below.

## Are You Using Appropriate Paper?

---

Check whether the paper in the machine is usable, and replace it with appropriate paper, as needed.

- ▶ **Usable Paper(P. 19)**
- ▶ **Loading Paper(P. 132)**

## Is Paper Loaded Correctly?

---

- Fan the paper thoroughly in small batches so that it is not stuck together.
- Align the edges by tapping the paper on a flat surface a few times before loading the paper. ▶ **Loading Paper(P. 132)**
- Do not load paper of different sizes or types together.

# Printed Paper Sticks Together

94WS-0J9

Troubleshoot by checking the items below.

## Are You Using Appropriate Paper?

- Check whether the paper in the machine is usable, and replace it with appropriate paper, as needed.
  - ▶ **Usable Paper(P. 19)**
  - ▶ **Loading Paper(P. 132)**
- Set the paper size and type correctly according to the loaded paper. ▶ **Specifying the Paper Size and Type(P. 139)**

## Try using [Reduce Ppr. Sticking at Output].

- Setting [Reduce Ppr. Sticking at Output] to [On] may improve the problem.

### Touch Panel Model

[Home] screen on the operation panel ▶ [Menu] ▶ [Adjustment/Maintenance] ▶ [Adjust Image Quality] ▶ [Special Processing] ▶ [Reduce Ppr. Sticking at Output] ▶ [On]

### 5 Lines LCD Model

[Home] screen on the operation panel ▶ [Menu] ▶ **OK** ▶ [Adjustment/Maintenance] ▶ **OK** ▶ [Adjust Image Quality] ▶ **OK** ▶ [Special Processing] ▶ **OK** ▶ [Reduce Ppr. Sticking at Output] ▶ **OK** ▶ [On] ▶ **OK**

\* If selecting [On] does not solve the problem, set [Output Adjustment Mode] to [On] also. ▶ **[Output Adjustment Mode](P. 425)**

\* This setting is also effective for 1-sided printing.

# Setting Up

---

94WS-0F5

This is a list of problems that can occur during setup of the machine. Check how to troubleshoot the problem based on the symptom.

## ■ Problems During Driver Installation

### ▶ **The Machine Connected via WSD Port Is Not Displayed During Driver Installation(P. 525)**

## ■ Problems with Wireless LAN and Wired LAN Connection

### **Cannot Connect to Wireless LAN**

Check whether the machine can connect to the network.

#### ▶ **Cannot Connect to Wireless LAN(P. 526)**

### **Cannot Connect to Wired LAN**

The IP address setting may have failed. Set the IP address again.

#### ▶ **Setting IPv4 Addresses(P. 70)**

#### ▶ **Setting IPv6 Addresses(P. 74)**

### **Cannot Connect to Wireless LAN and Wired LAN at the Same Time**

You cannot connect the machine to a wireless LAN and wired LAN at the same time. You can connect to USB and wireless LAN or USB and wired LAN at the same time.

### **Cannot Connect Using TLS Encryption**

If you specify a TLS version that is not supported by your OS operating system, browser, or other software, you will not be able to connect to the machine using TLS encryption.

Update your OS operating system and other software, or incrementally downgrade the TLS version until you can successfully connect to the machine. Note, however, that downgrading your TLS version may result in a connected environment that is not protected by adequate security.

#### ▶ **Using TLS(P. 310)**

## ■ Problems with USB Connection

### **The Computer Cannot Communicate with the Machine**

Try the following:

- Replace the USB cable. If the USB cable is long, replace it with a short cable.
- If you are using a USB hub, connect the machine directly to the computer using a USB cable.

# The Machine Connected via WSD Port Is Not Displayed During Driver Installation

94WS-0F6

Troubleshoot by checking the items below.

## Check the Settings of the Machine.

Configure the settings below if they have not been configured. The machine must be restarted to apply the settings.



### WSD Printing and Multicast Discovery Settings

Log in to Remote UI in System Manager Mode ▶ [Settings/Registration] ▶ [Network Settings] ▶ [WSD Settings] ▶ [Edit] ▶ select the [Use WSD Printing] and [Use Multicast Discovery] checkboxes ▶ [OK] ▶ restart the machine.

On the operation panel, select [Menu] in the [Home] screen, and then select [Preferences] to configure the settings.  **[WSD Settings](P. 397)**

## Check the OS Network Settings.

Configure the settings below if they have not been configured.

In Windows, click [] (Start) ▶ [] (Settings) ▶ [Network & Internet] ▶ [Status] ▶ [Change connection properties] ▶ [Network profile] ▶ [Private]

## Check Whether the Driver Is Installed.

Use the following procedure to check whether the driver of the machine is displayed.

In Windows, click [] (Start) ▶ [] (Settings) ▶ [Devices] ▶ [Printers & scanners] ▶ check whether the driver is displayed.

If the driver is displayed, it is installed. In this case, uninstall the driver, and then reinstall it. For details about uninstalling and installing drivers, see the driver manual at the online manual site. <https://oip.manual.canon/>

# Cannot Connect to Wireless LAN

94WS-0F7

Troubleshoot by checking the status of the computer, wireless LAN router (access point), and machine with the steps below.

- ▶ **Step 1: Checking the Status of the Computer and Wireless LAN Router(P. 526)**
- ▶ **Step 2: Checking the Status of the Machine and Wireless LAN Router(P. 526)**
- ▶ **Step 3: Reconnecting to a Wireless LAN(P. 526)**

## Step 1: Checking the Status of the Computer and Wireless LAN Router

### Have You Configured the Settings of the Computer and Wireless LAN Router?

Configure the required settings if they have not been configured.

### Are the Power Cables and Ethernet Cable Connected Correctly?

If any cables are connected incorrectly or disconnected, connect them correctly.

### Is the Power of Wireless LAN Router On?

If you cannot establish a connection even if the power is on, turn off the power of the computer and router and turn it on again.

## Step 2: Checking the Status of the Machine and Wireless LAN Router

### Is the Power of the Machine ON?

If the power is ON, turn OFF the power and turn it ON again.

### Is the Location Appropriate?

- The machine and wireless LAN router should be installed in a location without walls or other obstructions between the devices and within range of 50 m.
- Do not install near a microwave oven, cordless telephone, or other device that generates radio waves.

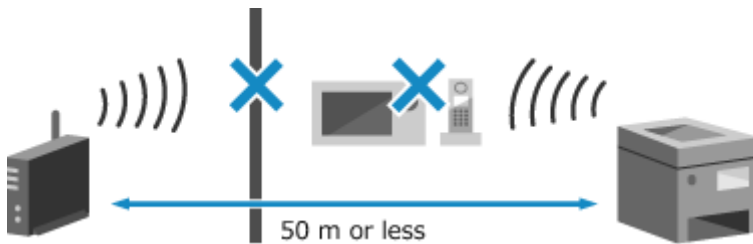

## Step 3: Reconnecting to a Wireless LAN

Connect to the wireless LAN using the connection type according to your wireless LAN router. ▶ **Connecting to a Wireless LAN(P. 54)**

# Network

---

94WS-0F8

This is a list of problems that can occur with the network. Check how to troubleshoot the problem based on the symptom.

- ▶ **Cannot Switch to Wireless LAN(P. 528)**
- ▶ **Cannot Find the Print Server to Connect to(P. 530)**
- ▶ **Cannot Connect to a Shared Printer(P. 531)**
- ▶ **Cannot Find the IP Address of the Machine(P. 532)**
- ▶ **AirPrint Does Not Work(P. 533)**



# Cannot Switch to Wireless LAN

94WS-0F9

Use the network settings to switch from wired LAN connection to wireless LAN connection.

▶ **Touch Panel Model(P. 528)**

▶ **5 Lines LCD Model(P. 528)**

## ■ Touch Panel Model

**1** On the operation panel, press [Menu] in the [Home] screen. ▶ [Home] Screen(P. 113)

**2** Press [Preferences] ▶ [Network] ▶ [Select Wired/Wireless LAN].

If the login screen appears, enter the System Manager ID and PIN, and then press [Log In]. ▶ **System Manager ID and PIN(P. 6)**

**3** Press [Wireless LAN].

⇒ The message [Settings applied.] appears.

**4** Connect the machine to the wireless LAN. ▶ **Connecting to a Wireless LAN(P. 54)**

**5** Install the driver to the computer that will use the machine.

When switching the machine from wired LAN connection to wireless LAN connection, any installed drivers must be uninstalled and then reinstalled.

For details about uninstalling and installing drivers, see the driver manual at the online manual site.  
<https://oip.manual.canon/>

## ■ 5 Lines LCD Model

**1** On the operation panel, select [Menu] in the [Home] screen, and press **OK**. ▶ [Home] Screen(P. 113)

**2** Press [Preferences] ▶ **OK** ▶ [Network] ▶ **OK** [Select Wired/Wireless LAN] ▶ **OK**.

⇒ The [Select Wired/Wireless LAN] screen is displayed.

If the login screen appears, enter the System Manager ID and PIN, and then press [<Log In>] ▶ **OK**. ▶ **System Manager ID and PIN(P. 6)**

**3** Press [Wireless LAN] ▶ **OK**.

⇒ The message [Settings applied.] appears.

**4 Connect the machine to the wireless LAN. ▶Connecting to a Wireless LAN(P. 54)**

**5 Install the driver to the computer that will use the machine.**

When switching the machine from wired LAN connection to wireless LAN connection, any installed drivers must be uninstalled and then reinstalled.

For details about uninstalling and installing drivers, see the driver manual at the online manual site.  
**<https://oip.manual.canon/>**

# Cannot Find the Print Server to Connect to

---

94WS-0FA

Troubleshoot by checking the items below.

## **Are the Print Server and Computer Connected Correctly?**

---

- Check the network settings of the print server and computer, and make sure they are connected correctly.
- If they are connected using an Ethernet cable, make sure the cable is connected correctly.

## **Is the Print Server Started?**

---

Start the print server if it has not been started.

## **Are there Any Restrictions with Connecting to the Print Server?**

---

Check with the administrator of the print server, and ask for permission, if needed.

## **Is Network Discovery Enabled? (Windows)**

---

Enable network discovery if not enabled. [▶Enabling Network Discovery\(P. 591\)](#)

## Cannot Connect to a Shared Printer

---

94WS-0FC

Check if a shared printer is displayed on the network computer. ▶ **Displaying a Shared Printer in the Print Server(P. 591)**

If it is not displayed, contact the network or print server administrator.

# Cannot Find the IP Address of the Machine

94WS-0FE

View the IP address using the following procedure:

## ■ Touch Panel Model

### Viewing the IPv4 Address



 on the operation panel ▶ [Status Monitor] ▶ [Network Information] ▶ [IPv4] ▶ view the setting.

### Viewing the IPv6 Address



 on the operation panel ▶ [Status Monitor] ▶ [Network Information] ▶ [IPv6] ▶ view the setting.

## ■ 5 Lines LCD Model

### Viewing the IPv4 Address

[Home] screen on the operation panel ▶ [Status Monitor] ▶  ▶ [Network Information] ▶  ▶ [IPv4] ▶  ▶ view the setting.

### Viewing the IPv6 Address

[Home] screen on the operation panel ▶ [Status Monitor] ▶  ▶ [Network Information] ▶  ▶ [IPv6] ▶  ▶ view the setting.

## NOTE

### If the IP Address Is Displayed as "0.0.0.0"

- A suitable IP address is not set. Set the IP address again.
  - ▶ [Setting IPv4 Addresses\(P. 70\)](#)
  - ▶ [Setting IPv6 Addresses\(P. 74\)](#)

# AirPrint Does Not Work

---

94WS-0FF

Troubleshoot by checking the items below.

## Is the Power of the Machine ON?

---

If the machine is ON, restart the machine, and try AirPrint again. [▶Restarting the Machine\(P. 106\)](#)

## Does an Error Message Appear on the Operation Panel?

---

Follow the instructions of the error message on the screen to fix the problem. [▶A Message Appears\(P. 560\)](#)

## When Using a Mac, Is it Correctly Connected to the Machine?

---

Connect the Mac to the network on the same LAN as the machine. [▶Setting Up the Network\(P. 49\)](#)  
When connecting via USB, directly connect the Mac to the USB port for computer connection on the back of the machine with a USB cable. [▶Rear Side\(P. 12\)](#)

## Have the Functions Usable with AirPrint Been Restricted?

---

If the protocol (IPP or Network Link Scan) for use with AirPrint has been disabled to restrict functions, cancel this restriction to enable the use of AirPrint. [▶Setting the Functions and Security to Be Used with AirPrint\(P. 284\)](#)

## Is Bonjour Enabled on Your Apple Device?

---

Enable Bonjour if it is not enabled. For details, see the manual of your Apple device.

# Printing and Copying

---

94WS-0FH

This is a list of problems that can occur when printing and copying. Check how to troubleshoot the problem based on the symptom.

▶ **Cannot Print or Copy(P. 535)**

▶ **Printing Is Slow(P. 542)**

## ■ Problems with Printing Results

If the printing or copying results are not as expected, see the following:

▶ **Problems with Printing Results(P. 496)**

## ■ Frequently Asked Questions about Operations

### **I Want to Print on an Envelope.**

Place the envelope in the paper drawer while paying attention to the orientation and side of the envelope. Then, set the paper size and type according to the placed envelope.

Next, use the printer driver of the computer to set the paper size of the document and the paper size to print, and then perform printing.

▶ **Preparations and Orientation for Loading Envelopes(P. 135)**

▶ **Specifying the Paper Size and Type(P. 139)**

▶ **Printing from a Computer(P. 182)**

# Cannot Print or Copy

---

94WS-0FJ

Troubleshoot by checking the items below.

## Has an Error Occurred?

---

Check the print or copy processing status and log, and if a three-digit number starting with "#" (error code) is displayed, check how to troubleshoot the problem based on the error code.

- ▶ **Viewing the Print Job Status and Log(P. 190)**
- ▶ **Checking the Copy Status(P. 270)**
- ▶ **An Error Code Is Displayed(P. 575)**

## Can You Print a Test Page?

---

If you can print a test page, check if the print settings of the application are correct.

- ▶ **Printing a Test Page(P. 597)**

## Check the Network Status and Settings.

---

Check the required items according to the usage environment.

- ▶ **Cannot Print (Wireless LAN)(P. 536)**
- ▶ **Cannot Print (Wired LAN)(P. 538)**
- ▶ **Cannot Print (USB Connection)(P. 540)**
- ▶ **Cannot Print (via Print Server)(P. 541)**



# Cannot Print (Wireless LAN)

94WS-0FK

Troubleshoot by checking the items below.

## Check the Wireless LAN Connection Status.

Check the connection status of the machine, and take action according to the status. [▶Viewing the MAC Address and Connection Information of the Wireless LAN\(P. 91\)](#)

### If the Machine Is Not Connected to the Wireless LAN

Check the status of the computer and wireless LAN router (access point) and the status of the machine, and reconnect to the wireless LAN. [▶Cannot Connect to Wireless LAN\(P. 526\)](#)

### If the Connection Is Poor

Change the following settings on the wireless LAN router, and try printing:

- Change the channel of the wireless LAN router. If there are multiple wireless LAN routers, separate the channels by five or more channels.
- Increase the wireless output of the wireless LAN router if possible.

## Are the Machine and Computer Connected to the Same Wireless LAN Router?

- When you are using a computer connected to a wireless LAN, check that the SSID (identifier of the wireless LAN router) of the machine matches that of the computer.
  - ▶[Viewing the MAC Address and Connection Information of the Wireless LAN\(P. 91\)](#)
  - ▶[Viewing the Network Connection Information of the Computer\(P. 594\)](#)
- If the SSID of the machine and the computer do not match, configure the wireless LAN connection settings on the machine again, and connect the machine to the SSID to which the computer is connected. [▶Connecting to a Wireless LAN\(P. 54\)](#)

## Is the Printer Port of the Computer Configured Correctly? (Windows)

Change the settings if they have not been configured correctly. If there is no available port, add a new port.

- ▶[Viewing the Printer Port\(P. 596\)](#)
- ▶[Configuring a Printer Port \(Windows\)\(P. 176\)](#)

## Can You Access Remote UI?

If you cannot access Remote UI, the firewall settings of the machine may be incorrect, preventing communication with the computer.

Use the following procedure to disable the firewall settings with the operation panel, and then use Remote UI to configure the firewall again.

Administrator privileges are required. The machine must be restarted to apply the settings.

- ▶[Touch Panel Model\(P. 536\)](#)
- ▶[5 Lines LCD Model\(P. 537\)](#)

### ■Touch Panel Model

- 1 Disable the firewall settings.

#### To Disable IPv4 Address Filter

[Home] screen on the operation panel ▶ [Menu] ▶ [Preferences] ▶ [Network] ▶ [Firewall Settings] ▶ [IPv4 Address Filter] ▶ [Outbound Filter] or [Inbound Filter] ▶ [Off] ▶ Restart the machine.

#### To Disable IPv6 Address Filter

[Home] screen on the operation panel ▶ [Menu] ▶ [Preferences] ▶ [Network] ▶ [Firewall Settings] ▶ [IPv6 Address Filter] ▶ [Outbound Filter] or [Inbound Filter] ▶ [Off] ▶ Restart the machine.

**To Disable MAC Address Filter**

[Home] screen on the operation panel ▶ [Menu] ▶ [Preferences] ▶ [Network] ▶ [Firewall Settings] ▶ [MAC Address Filter] ▶ [Outbound Filter] or [Inbound Filter] ▶ [Off] ▶ Restart the machine.

2 Configure the firewall correctly. ▶ **Setting the Firewall(P. 304)**

**■5 Lines LCD Model**

1 Disable the firewall settings.

**To Disable IPv4 Address Filter**

[Home] screen on the operation panel ▶ [Menu] ▶ **OK** ▶ [Preferences] ▶ **OK** ▶ [Network] ▶ **OK** ▶ [Firewall Settings] ▶ **OK** ▶ [IPv4 Address Filter] ▶ **OK** ▶ [Outbound Filter] or [Inbound Filter] ▶ **OK** ▶ [Off] ▶ **OK** ▶ Restart the machine.

**To Disable IPv6 Address Filter**

[Home] screen on the operation panel ▶ [Menu] ▶ **OK** ▶ [Preferences] ▶ **OK** ▶ [Network] ▶ **OK** ▶ [Firewall Settings] ▶ **OK** ▶ [IPv6 Address Filter] ▶ **OK** ▶ [Outbound Filter] or [Inbound Filter] ▶ **OK** ▶ [Off] ▶ **OK** ▶ Restart the machine.

**To Disable MAC Address Filter**

[Home] screen on the operation panel ▶ [Menu] ▶ **OK** ▶ [Preferences] ▶ **OK** ▶ [Network] ▶ **OK** ▶ [Firewall Settings] ▶ **OK** ▶ [MAC Address Filter] ▶ **OK** ▶ [Outbound Filter] or [Inbound Filter] ▶ **OK** ▶ [Off] ▶ **OK** ▶ Restart the machine.

2 Configure the firewall correctly. ▶ **Setting the Firewall(P. 304)**

**Reinstall the Printer Driver.**

Uninstall the installed driver, and then reinstall it.  
 For details about uninstalling and installing drivers, see the driver manual at the online manual site.  
<https://oip.manual.canon/>

**Are You Using Resident Software?**

If you are using resident software, such as security software, disable it and then try printing.

**Can You Print from Another Computer in the Network?**

If you cannot print from another computer, contact your dealer or service representative. ▶ **If the Problem Persists(P. 581)**

# Cannot Print (Wired LAN)

94WS-0FL

Troubleshoot by checking the items below.

## Is the Printer Port of the Computer Configured Correctly? (Windows)

Change the settings if they have not been configured correctly. If there is no available port, add a new port.

- ▶ **Viewing the Printer Port(P. 596)**
- ▶ **Configuring a Printer Port (Windows)(P. 176)**

## Can You Access Remote UI?

If you cannot access Remote UI, the firewall settings of the machine may be incorrect, preventing communication with the computer.

Use the following procedure to disable the firewall settings with the operation panel, and then use Remote UI to configure the firewall again.

Administrator privileges are required. The machine must be restarted to apply the settings.

- ▶ **Touch Panel Model(P. 538)**
- ▶ **5 Lines LCD Model(P. 538)**

### ■ Touch Panel Model

- 1 Disable the firewall settings.

#### To Disable IPv4 Address Filter

[Home] screen on the operation panel ▶ [Menu] ▶ [Preferences] ▶ [Network] ▶ [Firewall Settings] ▶ [IPv4 Address Filter] ▶ [Outbound Filter] or [Inbound Filter] ▶ [Off] ▶ Restart the machine.

#### To Disable IPv6 Address Filter

[Home] screen on the operation panel ▶ [Menu] ▶ [Preferences] ▶ [Network] ▶ [Firewall Settings] ▶ [IPv6 Address Filter] ▶ [Outbound Filter] or [Inbound Filter] ▶ [Off] ▶ Restart the machine.

#### To Disable MAC Address Filter

[Home] screen on the operation panel ▶ [Menu] ▶ [Preferences] ▶ [Network] ▶ [Firewall Settings] ▶ [MAC Address Filter] ▶ [Outbound Filter] or [Inbound Filter] ▶ [Off] ▶ Restart the machine.

- 2 Configure the firewall correctly. ▶ **Setting the Firewall(P. 304)**

### ■ 5 Lines LCD Model

- 1 Disable the firewall settings.

#### To Disable IPv4 Address Filter

[Home] screen on the operation panel ▶ [Menu] ▶ **OK** ▶ [Preferences] ▶ **OK** ▶ [Network] ▶ **OK** ▶ [Firewall Settings] ▶ **OK** ▶ [IPv4 Address Filter] ▶ **OK** ▶ [Outbound Filter] or [Inbound Filter] ▶ **OK** ▶ [Off] ▶ **OK** ▶ Restart the machine.

#### To Disable IPv6 Address Filter

[Home] screen on the operation panel ▶ [Menu] ▶ **OK** ▶ [Preferences] ▶ **OK** ▶ [Network] ▶ **OK** ▶ [Firewall Settings] ▶ **OK** ▶ [IPv6 Address Filter] ▶ **OK** ▶ [Outbound Filter] or [Inbound Filter] ▶ **OK** ▶ [Off] ▶ **OK** ▶ Restart the machine.

### To Disable MAC Address Filter

[Home] screen on the operation panel ▶ [Menu] ▶ **OK** ▶ [Preferences] ▶ **OK** ▶ [Network] ▶ **OK** ▶ [Firewall Settings] ▶ **OK** ▶ [MAC Address Filter] ▶ **OK** ▶ [Outbound Filter] or [Inbound Filter] ▶ **OK** ▶ [Off] ▶ **OK** ▶ Restart the machine.

- 2 Configure the firewall correctly. ▶ **Setting the Firewall(P. 304)**

### Reinstalling the Printer Driver

---

Uninstall the installed driver, and then reinstall it.

For details about uninstalling and installing drivers, see the driver manual at the online manual site.

<https://oip.manual.canon/>

### Are You Using Resident Software?

---

If you are using resident software, such as security software, disable it and then try printing.

### Can You Print from Another Computer in the Network?

---

If you cannot print from another computer, contact your dealer or service representative. ▶ **If the Problem Persists(P. 581)**

# Cannot Print (USB Connection)

---

94WS-0FR

Troubleshoot by checking the items below.

## Check the USB Cable.

---

- If you are using a long USB cable, replace it with a short USB cable.
- If you still cannot print with a short USB cable, the cable may be damaged. Replace with a new USB cable, and try printing.

## Are You Using a USB Hub?

---

Connect the machine directly to the computer using a USB cable.

## Try Using Another USB Port.

---

Connect the USB cable to another USB port on your computer.

## Is the Printer Port of the Computer Configured Correctly? (Windows)

---

If the printer port is not configured correctly or there is no available port, reinstall the printer driver. When you reinstall the driver, the correct port is configured automatically. ▶ **Viewing the Printer Port(P. 596)**  
For details about installing the driver, see the manual of the driver at the online manual site.  
<https://oip.manual.canon/>

## Is Two-way Communication Between the Machine and Computer Enabled? (Windows)

---

Enable two-way communication if it is not enabled, and restart the computer and machine. ▶ **Viewing Two-way Communication(P. 597)**

## Is a Setting Preventing the Machine from Establishing a USB Connection to the Computer?

---

If usage of the USB port for computer connection on the back of the machine is restricted, cancel this setting. ▶ **Preventing Connection to Computer via USB Port(P. 341)**

## Are You Using Resident Software?

---

If you are using resident software, such as security software, disable it and then try printing.

## Can You Print via USB Connection from Another Computer?

---

If you cannot print from another computer, contact your dealer or service representative. ▶ **If the Problem Persists(P. 581)**

## Cannot Print (via Print Server)

---

94WS-0FS

Troubleshoot by checking the items below.

### Can You Print from the Print Server?

---

If you can print, check the connection between the computer and the print server. ▶ **Cannot Find the Print Server to Connect to(P. 530)**

### Reinstall the Printer Driver.

---

Uninstall the installed driver, and then reinstall it.

For details about uninstalling and installing drivers, see the driver manual at the online manual site.

<https://oip.manual.canon/>

#### Installing in Windows

Use a print server to install the printer driver.

Double-click the shared printer on the print server, and follow the instructions on the screen to install the printer driver. ▶ **Displaying a Shared Printer in the Print Server(P. 591)**

### Are You Using Resident Software?

---

If you are using resident software, such as security software, disable it and then try printing.

### Can You Print via a Print Server from Another Computer?

---

If you cannot print from another computer, contact your dealer or service representative. ▶ **If the Problem Persists(P. 581)**

## Printing Is Slow

---

94WS-0FU

It takes time until the first page is printed. The printing speed may be slower after continuous printing or printing on narrow paper to allow for adjustments of the temperature or image quality of the machine.

In all other cases, an error may have occurred. Troubleshoot by checking the items below.

### **Check the Paper Orientation.**

---

This symptom may occur depending on the paper orientation. Change the paper orientation if possible. ▶  
**Loading Paper(P. 132)**

# Scanning

---

94WS-0FW

If you have problems when scanning, restart the machine and computer.

If the problem persists even after restarting, check the following troubleshooting methods.

▶ **Cannot Save Scanned Data to a Computer(P. 544)**

## ■ Frequently Asked Questions about Operations

### **I Want to Scan an Original.**

Make preparations according to the scanned data save destination and sending method, and then scan the original.

▶ **Scanning(P. 193)**



# Cannot Save Scanned Data to a Computer

94WS-0FX

Use the following steps to check the status of the computer used as the store location and the machine:

- ▶ **Step 1: Checking the Occurrence of the Problem(P. 544)**
- ▶ **Step 2: Checking the Status of the Computer(P. 544)**
- ▶ **Step 3: Checking the Status of the Machine(P. 544)**
- ▶ **Step 4: Checking the Store Location of the Scanned Data(P. 545)**

## Step 1: Checking the Occurrence of the Problem

Check using the following in the order below:

### Does the Problem Occur on All Computers?

If so, check the network status and settings of the machine. If the machine is not connected to a network, reconfigure the network settings.

- ▶ **Checking the Network Status and Settings(P. 88)**
- ▶ **Setting Up the Network(P. 49)**

### Are You Saving Scanned Data to the Computer for the First Time?

If so, make preparations such as installing the scanner driver (ScanGear MF) and application (MF Scan Utility) to the computer used as the store location. ▶ **Preparing to Save Scanned Data to a Computer(P. 194)**

### On the Screen for Selecting the Computer to Be Used as the Store Location, Is the Computer Displayed? (Only When Scanning from the Machine)

If the computer to be used as the store location is not displayed, scanned data communication may be blocked due to the security software settings.

For details about the security software settings, contact the software manufacturer.

## Step 2: Checking the Status of the Computer

### Did You Install and Update the Security Software?

If so, the security may have been strengthened, preventing communication between the machine and computer.

For a workaround, contact the software manufacturer.

### Reinstall the Scanner Driver.

Uninstall the installed driver, and then reinstall it.

For details about uninstalling and installing drivers, see the driver manual at the online manual site.

<https://oip.manual.canon/>

## Step 3: Checking the Status of the Machine

### Was the IP Address of the Machine or Other Device Changed?

If so, check whether the machine and other device have the same IP address. If they have the same IP address, change it to a different IP address.

- ▶ **Setting IPv4 Addresses(P. 70)**
- ▶ **Setting IPv6 Addresses(P. 74)**

## Step 4: Checking the Store Location of the Scanned Data

### Check the Attributes of the Store Location (Windows).

---

On the computer, check that the attributes of the store location are not read only.

- 1** Right-click the store location, and click [Properties].
  - ▣ The properties screen of the store location is displayed.
- 2** On the [General] tab, check that the [Read-only] checkbox in [Attributes] is not selected.
- 3** If the checkbox is selected, clear the [Read-only] checkbox.

# Faxing and Using the Telephone

---

94WS-0H0

This is a list of problems that can occur when faxing and using the telephone. Check how to troubleshoot the problem based on the symptom.

- ▶ **Cannot Send a Fax(P. 547)**
- ▶ **Cannot Receive a Fax(P. 549)**
- ▶ **Machine Does Not Automatically Switch Between Telephone and Fax(P. 551)**
- ▶ **Cannot Send or Receive a Fax via Optical Line(P. 552)**
- ▶ **Cannot Send a Fax to an International Destination(P. 553)**
- ▶ **Other Party's Telephone or Fax Number Is Not Displayed(P. 554)**

## ■ Frequently Asked Questions about Operations

### **I Want to Forward or Save a Received Fax.**

Configure the settings to automatically forward or save received faxes to a computer, other fax machine, or other destination.

- ▶ **Auto Forwarding and Backing Up Received Faxes(P. 219)**

### **I Want to Send a Fax from a Computer.**

You can send a document as a fax from a computer using a fax driver.

- ▶ **Sending Faxes from a Computer (PC Faxing)(P. 225)**

# Cannot Send a Fax

94WS-0H1

Troubleshoot by checking the following steps:

- ▶ **Step 1: Checking the Original(P. 547)**
- ▶ **Step 2: Checking the Status of the Machine(P. 547)**
- ▶ **Step 3: Checking the Send Status(P. 548)**

## Step 1: Checking the Original

### Is Original Placed Correctly?

Place the original correctly while paying attention to the orientation of the side to be scanned.

#### When Placing It on the Platen Glass

Place the original with the side to be scanned face down. ▶ **Placing Originals on the Platen Glass(P. 129)**

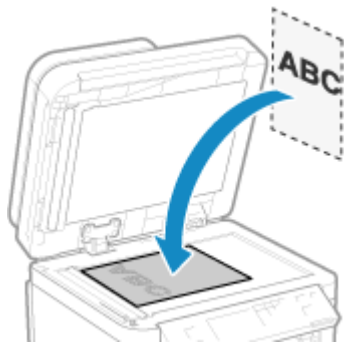

#### When Placing Originals in the Feeder

Place the original with the side to be scanned face up. ▶ **Placing Originals in the Feeder(P. 130)**



## Step 2: Checking the Status of the Machine

### Is the Data Indicator on the Operation Panel Lit or Blinking?

If so, data is being processed. Data is sent after the data indicator turns off. ▶ **Operation Panel(P. 14)**

### Is the Telephone Cord Connected Correctly?

Check that the supplied telephone cord is connected correctly to the telephone line jack (LINE) on the machine and the telephone line connector on the wall, and fix the connection, as needed.

For details about the connection method, see the procedure for connecting to the telephone line. ▶ **Step 4: Connecting to Telephone Line(P. 96)**

### Are You Talking on a Telephone Connected to the Machine?

Send the fax after the call is completed.

### Has an Error Occurred?

Check the fax sending status and log, and if a three-digit number (error code) starting with "#" is displayed, check how to troubleshoot the problem based on the error code.

- ▶ **Checking the Status and Log for Sent and Received Faxes(P. 236)**
- ▶ **An Error Code Is Displayed(P. 575)**

### Is [Memory is full.] Displayed on the Operation Panel?

If so, scanning of the original cannot be performed due to insufficient available memory. Try the following:

- If there is data waiting to be printed or sent, wait until the processing is completed.
- When sending an original with many pages, divide the original and send it.
- Check the faxes received in the memory of the machine, and print or forward them as needed, and delete any unnecessary faxes. ▶ **Viewing and Printing Faxes Saved in the Memory(P. 332)**
- Change the set resolution to a lower resolution when scanning the original.

[Home] screen on the operation panel ▶ [Fax] ▶ [Resolution] ▶ select the resolution.

## Step 3: Checking the Send Status

### Did You Specify a Correct Destination?

A telephone number may have been specified, or the fax number may be incorrect. Check that the specified destination is correct, and send again.

### Are You Sending a Fax via Optical Line

The machine conforms to analog line standards, and sending of faxes via optical line cannot be guaranteed. You may be able to perform operations via optical line, so see the following.

- ▶ **Cannot Send or Receive a Fax via Optical Line(P. 552)**

### Is the Type of Telephone Line Configured Correctly?

The type of telephone line may not be automatically configured correctly. Configure the type of telephone line manually.

Log in to Remote UI ▶ [Settings/Registration] ▶ [TX Settings] ▶ [Fax TX Settings] ▶ [Edit] ▶ in [Select Line Type], select [Manual] ▶ in [Line], select the type of telephone line ▶ [OK]

On the operation panel, select [Menu] in the [Home] screen, and then select [Function Settings] to configure the settings. ▶ **Select Line Type(P. 437)**

\* If you do not know the type of telephone line, contact your telephone company.

### Did You Specify an Overseas Destination?

If so, you may not have been able to connect correctly to the destination. After entering the international access number or country code, enter the wait time (pause) and lower the communication start speed before sending the fax. ▶ **Cannot Send a Fax to an International Destination(P. 553)**

### Is the Send Destination Ready to Receive a Fax?

The power of the receiving device may not be turned on, or the RX Mode may not be configured correctly. Have the other party check these.

# Cannot Receive a Fax

94WS-0H2

Troubleshoot by checking the following steps:

- ▶ **Step 1: Checking the Remaining Amount of Toner in the Toner Cartridge(P. 549)**
- ▶ **Step 2: Checking the RX Mode Setting(P. 549)**
- ▶ **Step 3: Checking the Fax Reception Environment(P. 550)**
- ▶ **Step 4: Free Up Memory on the Machine(P. 550)**

## Step 1: Checking the Remaining Amount of Toner in the Toner Cartridge

If the remaining amount of toner in the toner cartridge is low, the received data may be saved to the memory of the machine without being printed to prevent printing text that is difficult to read or images that are difficult to see.

- Check the remaining amount of toner in the toner cartridge, and replace any toner cartridge, as needed.
  - ▶ **Checking the Remaining Amount of Consumables(P. 477)**
  - ▶ **Replacing the Toner Cartridge(P. 471)**
- To print the received data even when the amount of toner in the toner cartridge is low, enable [Continue Printing When Amount in Cartridge Is Low].

Log in to Remote UI ▶ [Settings/Registration] ▶ [RX/Forwarding Settings] or [RX Settings] ▶ [Common Settings] ▶ [Edit] in [Common Settings] ▶ select the [Continue Printing When Amount in Cartridge Is Low] checkbox ▶ [OK]

On the operation panel, select [Menu] in the [Home] screen, and then select [Function Settings] to configure the settings. ▶ **[Continue Print. When Amount in Cart. Low](P. 442)**

\* When this setting is enabled, the print result may be light or faded. The received data is not saved to the memory, so if the printed content is illegible, you may have to request the sender to send the data again.

## Step 2: Checking the RX Mode Setting

### Is the RX Mode Set Appropriately?

Check that the RX Mode is set according to your fax purpose, and change the setting, as needed. ▶ **Changing Fax RX Mode and Setting the Action when Receiving a Fax(P. 215)**

### Is the RX Mode Set to [Answering Machine]?

If so, check the following, and connect the telephone correctly:

- An answering machine is connected to the machine.
- The power is turned on with a message recorded properly.

### Is the RX Mode Set to [Manual]?

If so, press [Start Receiving] before hanging up the receiver when receiving a fax. Hanging up the receiver beforehand may end the call.

If a telephone is connected to the machine, you can receive the fax by operating the telephone without operating the machine. ▶ **Receiving Faxes via Telephone (Remote RX)(P. 232)**

## Step 3: Checking the Fax Reception Environment

### Are You Receiving a Fax via an Optical Line?

The machine conforms to analog line standards, and receiving of faxes via optical line cannot be guaranteed. You may be able to perform operations via optical line, so see the following:

❏ **Cannot Send or Receive a Fax via Optical Line(P. 552)**

### Are You Receiving a Fax from a Fax Information Service?

If so, perform the following operations according to the type of telephone line connected to the machine.

#### When Using a Tone Dialing Line

Configure the type of telephone line manually, and then call your service provider.

Log in to Remote UI ▶ [Settings/Registration] ▶ [TX Settings] ▶ [Fax TX Settings] ▶ [Edit] ▶ in [Select Line Type], select [Manual] ▶ in [Line], select [Tone] ▶ [OK]

On the operation panel, select [Menu] in the [Home] screen, and then select [Function Settings] to configure the settings. ❏ **[Select Line Type](P. 437)**

#### When Using a Pulse Dialing Line

After calling your service provider, press " \* " (Tone) on the numeric keys, and then enter the number to receive service.

\* If you do not know the type of telephone line, contact your telephone company.

## Step 4: Free Up Memory on the Machine

Check the faxes received in the memory of the machine, and print or forward them as needed, and delete any unnecessary faxes. ❏ **Viewing and Printing Faxes Saved in the Memory(P. 332)**

# Machine Does Not Automatically Switch Between Telephone and Fax

94WS-0H3

Troubleshoot by checking the items below.

## Is the RX Mode Set Appropriately?

- Check that the RX Mode is set according to your fax purpose, and change the setting, as needed. **▶ Changing Fax RX Mode and Setting the Action when Receiving a Fax(P. 215)**
- When a regular telephone or optional TELEPHONE 6 KIT is connected, set the RX Mode to [Fax/Tel (Auto Switch)].

## Is the Ring Start Time Too Short When the RX Mode Is Set to [Fax/Tel (Auto Switch)]?

If the time until ringing starts after receiving a fax is too short, the machine may not be able to determine that it is a fax and you may hear an incoming ring when the fax is received. Check the [Ring Start Time] setting, and increase the time, as needed.

[Home] screen on the operation panel ▶ [Fax] ▶ [RX Mode] ▶ [Fax/Tel (Auto Switch)] ▶ [Ring Start Time] ▶ enter a time ▶ [Apply]

## Is the Line Status of the Sender Good?

If the line status of the sender is poor, the machine may not switch to fax at a fast communication start speed. Check the [RX Start Speed] setting, and decrease the speed, as needed.

Log in to Remote UI in System Manager Mode ▶ [Settings/Registration] ▶ [RX/Forwarding Settings] ▶ [Fax RX Settings] ▶ [Edit] in [Basic Settings] ▶ in [RX Start Speed], select the speed ▶ [OK]

On the operation panel, select [Menu] in the [Home] screen, and then select [Function Settings] to configure the settings. **▶ [RX Start Speed](P. 445)**

## Does the Machine Have Sufficient Free Memory?

Check the faxes received in the memory of the machine, and print or forward them as needed, and delete any unnecessary faxes. **▶ Viewing and Printing Faxes Saved in the Memory(P. 332)**

## Does the Sender's Fax Machine Support a Fax Identification Signal (CNG Signal)\*1?

If it does not support this signal, the machine will not switch automatically to fax receiving mode. Change the RX Mode to [Manual] to receive faxes manually. **▶ Changing Fax RX Mode and Setting the Action when Receiving a Fax(P. 215)**

\*1 The fax identification signal (CNG signal) is a beeping sound transmitted by the sending fax machine.



## Cannot Send or Receive a Fax via Optical Line

94WS-0H4

The machine conforms to analog line standards, and sending and receiving of faxes via optical line cannot be guaranteed. You may be able to perform operations via optical line, so use the following steps:

### Check the Optical Line Provider.

Check with the optical line provider that the following two items are guaranteed:

- Call quality equivalent to analog line level
- Guaranteed operation of Super G3 (fax communication standard)

### Lower the Communication Start Speed and Check the Sending and Receiving Status.

Use the following procedure to lower the communication start speed in phases and check whether you can send and receive faxes:

#### Cannot Send a Fax

Log in to Remote UI in System Manager Mode ▶ [Settings/Registration] ▶ [TX Settings] ▶ [Fax TX Settings] ▶ [Edit] ▶ in [TX Start Speed], select the speed ▶ [OK]

On the operation panel, select [Menu] in the [Home] screen, and then select [Function Settings] to configure the settings. **Ⓞ[TX Start Speed](P. 437)**

#### Cannot Receive a Fax

Log in to Remote UI in System Manager Mode ▶ [Settings/Registration] ▶ [RX/Forwarding Settings] ▶ [Fax RX Settings] ▶ [Edit] in [Basic Settings] ▶ in [RX Start Speed], select the speed ▶ [OK]

On the operation panel, select [Menu] in the [Home] screen, and then select [Function Settings] to configure the settings. **Ⓞ[RX Start Speed](P. 445)**

## Cannot Send a Fax to an International Destination

94WS-0H5

Troubleshoot by checking the items below.

### Enter the Wait Time (Pause).

- When sending a fax to an international destination, enter the international access number, country code, and fax number of the destination in that order. Press [Pause] in between the numbers to add a pause.

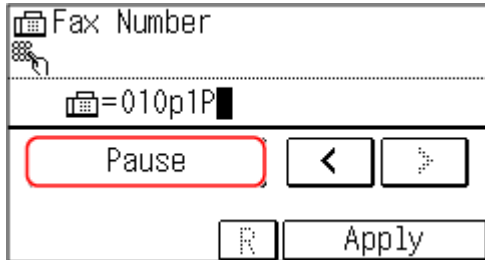

- If you still cannot send a fax after entering a pause, change the pause time.

Log in to Remote UI ▶ [Settings/Registration] ▶ [TX Settings] ▶ [Fax TX Settings] ▶ [Edit] ▶ in [Set Pause Time], enter the pause time ▶ [OK]

On the operation panel, select [Menu] in the [Home] screen, and then select [Function Settings] to change the setting. ◀[Set Pause Time](P. 436)

### Lower the Communication Start Speed.

Try sending a fax after lowering the communication start speed in phases.

Log in to Remote UI in System Manager Mode ▶ [Settings/Registration] ▶ [TX Settings] ▶ [Fax TX Settings] ▶ [Edit] ▶ in [TX Start Speed], select the speed ▶ [OK]

On the operation panel, select [Menu] in the [Home] screen, and then select [Function Settings] to configure the settings. ◀[TX Start Speed](P. 437)

# Other Party's Telephone or Fax Number Is Not Displayed

---

94WS-0H6

Troubleshoot by checking the items below.

## Is the Machine Connected to a Telephone That Supports Number Display?

---

The machine does not support number display. When a telephone that supports number display is connected to the machine, the other party's number can be displayed on the display of the telephone.

\* The other party's number may not be displayed even if a telephone that supports number display is connected to the machine. For details, see the manual of the telephone.

## Is the RX Mode Set to [Auto] or [Fax/Tel (Auto Switch)]?

---

If so, when the settings are configured so that the machine rings when receiving a fax, the other party's number can be displayed on a connected telephone that supports number display while the machine is ringing.

Log in to Remote UI ▶ [Settings/Registration] ▶ [RX/Forwarding Settings] or [RX Settings] ▶ [Fax RX Settings] ▶ [Edit] ▶ select the [Use Incoming Ring] checkbox ▶ enter the number of rings ▶ [OK]

On the operation panel, select [Menu] in the [Home] screen, and then select [Function Settings] to configure the settings. ▶ **[Incoming Ring](P. 444)**

# Management Functions and Environment Settings

---

94WS-0H7

This is a list of frequently asked questions about management functions. Check the applicable item.

- ▶ **Cannot Access Remote UI(P. 556)**
- ▶ **Changing the Time Until Sleep Mode(P. 557)**
- ▶ **Lost Department ID or PIN for the Administrator(P. 558)**
- ▶ **Checking the Items That Can Be Configured on the Machine and Their Settings(P. 559)**

## Cannot Access Remote UI

94WS-0H8

If the message [Cannot access Remote UI.] or [Cannot continue the settings because the function to perform settings for the device is restricted.] appears and you cannot access Remote UI, troubleshoot by checking the items below.

### Set the Remote UI Access PIN.

To access the Remote UI, you must set the Remote UI Access PIN.

Administrator privileges are required to configure the setting.

#### Touch Panel Model

[Home] screen on the operation panel ▶ [Menu] ▶ [Management Settings] ▶ [Remote UI Settings/Update Firmware] ▶ [Remote UI Settings] ▶ [Remote UI Access Security Settings] ▶ [On] ▶ enter the PIN ▶ [Apply] ▶ enter the PIN again ▶ [Apply]

#### 5 Lines LCD Model

[Home] screen on the operation panel ▶ [Menu] ▶ **OK** ▶ [Management Settings] ▶ **OK** ▶ [Remote UI Settings/Update Firmware] ▶ **OK** ▶ [Remote UI Settings] ▶ **OK** ▶ [Remote UI Access Security Settings] ▶ **OK** ▶ [On] ▶ **OK** ▶ enter the PIN ▶ **OK** ▶ enter the PIN again ▶ **OK**

\* You cannot set a PIN consisting of all zeros, such as "00" or "0000000."

### Change the System Manager PIN.

When logging in with System Manager Mode, you must change the System Manager PIN from the default settings.

Administrator privileges are required to change the settings.

#### Touch Panel Model

[Home] screen on the operation panel ▶ [Menu] ▶ [Management Settings] ▶ [User Management] ▶ [System Manager Information Settings] ▶ [System Manager ID and PIN] ▶ enter the System Manager ID ▶ [Apply] ▶ enter the PIN ▶ [Apply] ▶ enter the PIN again ▶ [Apply]

#### 5 Lines LCD Model

[Home] screen on the operation panel ▶ [Menu] ▶ **OK** ▶ [Management Settings] ▶ **OK** ▶ [User Management] ▶ **OK** ▶ [System Manager Information Settings] ▶ **OK** ▶ [System Manager ID and PIN] ▶ **OK** ▶ enter the System Manager ID ▶ **OK** ▶ enter the PIN ▶ **OK** ▶ enter the PIN again ▶ **OK**

\* You cannot set a System Manager ID or PIN consisting of all zeros, such as "00" or "0000000."

\* Only allow certain administrators to have access to the System Manager ID and PIN after the settings are changed.

## Changing the Time Until Sleep Mode

---

94WS-0HA

In addition to being able to change the time until the machine enters sleep mode, you can also configure a specified time the machine enters sleep mode.

▶ **Reducing Power Consumption (Sleep Mode)(P. 107)**

## Lost Department ID or PIN for the Administrator

---

94WS-0HC

Contact the administrator to check whether the System Manager ID and System Manager PIN were changed from the default settings.

The System Manager ID and System Manager PIN are not set by default.

\* If they have not been changed from the default settings, change them for enhanced security, and allow only certain administrators to know this information. ▶ **Setting the Department ID and PIN for the Administrator(P. 301)**

### NOTE

- If you still cannot recover your System Manager ID and PIN even after confirming the above information, contact your dealer or service representative. ▶ **If the Problem Persists(P. 581)**

# Checking the Items That Can Be Configured on the Machine and Their Settings

---

94WS-0HE

You can print the User Data List and System Manager Data List to check the items that can be configured on the machine and their settings.

▶ **Printing and Viewing Reports and Lists(P. 358)**

**User Data List**

Displays the settings that do not require administrator privileges.

**System Manager Data List**

Displays the settings that require administrator privileges.



## A Message Appears

94WS-0HF

If a message appears on the operation panel, select the message from the list below, and check how to troubleshoot the problem.

- ▶ Cannot analyze the authentication server certificate.(P. 561)
- ▶ Cannot change the destination type of any destination that is registered to a group.(P. 561)
- ▶ Cannot find the access point.(P. 562)
- ▶ Cannot print. A non-Canon or counterfeit cartridge may be in use. Close: Press OK(P. 562)
- ▶ Cannot print RX data.(P. 562)
- ▶ Cannot receive the fax. Make sure the fax was sent correctly by the sender.(P. 563)
- ▶ Cannot send because more than one destination is specified.(P. 563)
- ▶ Cannot specify a group.(P. 563)
- ▶ Cart. Comm. Error Cannot print. A non-Canon or counterfeit cartridge may be in use. Close: Press OK(P. 563)
- ▶ Cartridge Comm. Error Problems caused by non-Canon cart. not covered by warranty. Close: Press OK(P. 563)
- ▶ Change the authentication password.(P. 564)
- ▶ Check the authentication settings.(P. 564)
- ▶ Could not connect.(P. 564)
- ▶ Could not connect. Check the encryption key settings.(P. 564)
- ▶ Could not connect. Max connections to access point reached(P. 564)
- ▶ Could not connect using the wireless LAN.(P. 565)
- ▶ Could not connect using WPS.(P. 565)
- ▶ Could not detect any connections from wireless devices.(P. 565)
- ▶ Could not perform cleaning.(P. 566)
- ▶ Could not perform IEEE 802.1X authentication. Cannot analyze the authentication server certificate. (P. 566)
- ▶ Could not perform IEEE 802.1X authentication. Change the authentication password.(P. 566)
- ▶ Could not perform IEEE 802.1X authentication. Check the authentication settings.(P. 566)
- ▶ Could not perform IEEE 802.1X authentication. Configure the correct authentication information.(P. 566)
- ▶ Could not perform IEEE 802.1X authentication. Configure the information required for authentication. (P. 566)
- ▶ Could not perform IEEE 802.1X authentication. No reply from the destination.(P. 567)
- ▶ Could not perform IEEE 802.1X authentication. The authentication server certificate has expired.(P. 567)
- ▶ Could not perform IEEE 802.1X authentication. The authentication server certificate is incorrect.(P. 567)
- ▶ Could not perform Open System auth. Chk encryp. key set.(P. 567)
- ▶ Could not perform Shared Key auth. Chk encryp. key set.(P. 567)
- ▶ Device will restart to connect using Easy Connection via PC. Is it OK?(P. 568)
- ▶ Direct Connection terminated.(P. 568)
- ▶ Easy Conn. via PC ended due to timeout Device will restart.(P. 568)
- ▶ Encryption key is not set correctly. Check the encryption key settings.(P. 568)
- ▶ End of Cart. Lifetime(P. 569)
- ▶ IEEE 802.1X error. Cannot analyze auth. server certificate.(P. 569)
- ▶ IEEE 802.1X error. Change the auth. password.(P. 569)
- ▶ IEEE 802.1X error. Check the auth. settings.(P. 570)
- ▶ IEEE 802.1X error. Configure correct authentication info.(P. 570)
- ▶ IEEE 802.1X error. Configure the info. required for auth.(P. 570)
- ▶ IEEE 802.1X error. No reply from the destination.(P. 570)
- ▶ IEEE 802.1X error. The auth. server cert. has expired.(P. 569)
- ▶ IEEE 802.1X error. The auth. server cert. is incorrect.(P. 569)
- ▶ Incorrect number of characters/invalid characters entered.(P. 570)
- ▶ Low Cartridge Level(P. 570)

- ▶ **Mem. Full (Skip Error)(P. 571)**
- ▶ **Memory is full.(P. 571)**
- ▶ **No reply from the destination.(P. 571)**
- ▶ **No response from host.(P. 571)**
- ▶ **Paper jammed.(P. 572)**
- ▶ **Prepare a cartridge.(P. 572)**
- ▶ **Set the correct authentication information.(P. 572)**
- ▶ **Set the information necessary for authentication.(P. 572)**
- ▶ **Size/Settings Mismatch(P. 573)**
- ▶ **Specifying and registering new destinations is restricted.(P. 573)**
- ▶ **The authentication server certificate has expired.(P. 573)**
- ▶ **The authentication server certificate is incorrect.(P. 573)**
- ▶ **The fax number has too many digits.(P. 573)**
- ▶ **The memory is full. Scanning will be canceled. Print?(P. 574)**
- ▶ **Use Remote UI to set info. necessary for authentication.(P. 574)**

## NOTE

- If the problem persists even after trying the troubleshooting methods, contact your dealer or service representative. ▶ **If the Problem Persists(P. 581)**

### Cannot analyze the authentication server certificate.

The certificate of the authentication server may not be correct, or it may be a format unsupported by the machine.

**Check the Certificate of the Authentication Server, and Change the Setting, as Needed.**

- ▶ **Setting IEEE 802.1X(P. 312)**

### Cannot change the destination type of any destination that is registered to a group.

The selected destination is registered to a group, so you cannot change the destination type.

**Delete the Destination from the Group, Change the Destination Type, and Then Register It to the Group Again.**

- 1 Delete the destination from the group.

#### **Deleting Using Remote UI**

Log in to Remote UI in System Manager Mode ▶ [Address Book] ▶ [One-Touch] or [Coded Dial] ▶ select the group to which the destination is registered ▶ [Edit] ▶ select the destination ▶ [Delete] ▶ [OK]

#### **Deleting Using the Operation Panel**

[Home] screen on the operation panel ▶ [Addr. Book] ▶ [Details/Edit] ▶ select the group to which the destination is registered ▶ [Edit] ▶ [Number of Destinations:] ▶ select the destination ▶ [Remove] ▶ [Yes] ▶ [Apply] ▶ [Apply]

- 2 Change the destination type.

▶ **Registering Destinations to the Address Book (Remote UI) (Touch Panel Model)(P. 155)**

▶ **Editing and Deleting Destinations in the Address Book (Operation Panel) (Touch Panel Model) (P. 154)**

- 3 Register the destination to the group again.
  - ▶ **Registering Groups to the Address Book (Remote UI) (Touch Panel Model)(P. 157)**
  - ▶ **Registering Groups to the Address Book (Operation Panel) (Touch Panel Model)(P. 152)**

## Cannot find the access point.

An error occurred, preventing the machine from detecting the wireless LAN router (access point).

### Is Connection Type Configured Correctly?

Select the connection type (WPS) according to the method supported by the wireless LAN router. ▶ **Connecting to a Wireless LAN by Using the Router Button (Push Button Mode)(P. 57)**

### Did You Connect Within the Fixed Time?

When connecting by pressing a button on the wireless LAN router, set the connection type on the operation panel of the machine, and then press the button on the wireless LAN router within one or two minutes. ▶ **Connecting to a Wireless LAN by Using the Router Button (Push Button Mode)(P. 57)**

### Are the SSID and Network Key Configured Correctly?

When entering the wireless LAN router information manually, check the SSID and network key of the wireless LAN router, and configure the settings correctly on the machine. ▶ **Connecting to a Wireless LAN by Setting the Details (Manual Setup Method)(P. 65)**

### Are the Machine and Wireless LAN Router Located Appropriately?

- The machine and wireless LAN router should be installed in a location without walls or other obstructions between the devices and within range of 50 m.
- Do not install near a microwave oven, digital cordless telephone, or other device that generates radio waves.

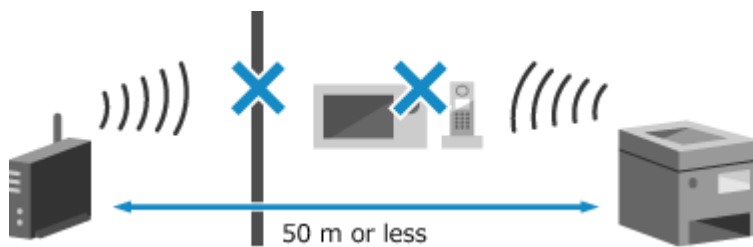

### Check the Security Settings of the Wireless LAN Router.

For details, see the manual of the wireless LAN router or contact the manufacturer.

## Cannot print. A non-Canon or counterfeit cartridge may be in use. Close: Press OK

Printing cannot be performed due to the use of a toner cartridge whose print quality cannot be guaranteed.

### Replace with a New Toner Cartridge.

▶ **Replacing the Toner Cartridge(P. 471)**

For optimum print quality, using Canon genuine toner cartridges is recommended. ▶ **List of Consumables(P. 478)**

## Cannot print RX data.

Received data cannot be printed for some reason.

### Do the Cause and Solution Appear on the Operation Panel?

If so, follow the instructions on the screen.

### Is the Front Cover, Rear Cover, or Feeder Cover Open on the Machine?

Close the covers if they are open.

### Is Paper Loaded?

Load paper if not loaded. ▶ **Loading Paper(P. 132)**

**Is Paper Jammed?**

If so, remove any jammed paper. ▶ **Paper Jams(P. 487)**

**Have the Toner Cartridge Reached the End of Their Lifetime?**

Check the remaining amount of toner in the toner cartridge, and replace any toner cartridge, as needed.

▶ **Checking the Remaining Amount of Consumables(P. 477)**

▶ **Replacing the Toner Cartridge(P. 471)**

**Cannot receive the fax. Make sure the fax was sent correctly by the sender.**

Operations were not performed within the fixed time when receiving a fax manually, and the machine timed out.

**When You Hear a Beep During Fax Reception, Press [Start Receiving] Within 35 Seconds.**

[Home] screen on the operation panel ▶ [Fax] ▶ [Start Receiving]

**Cannot send because more than one destination is specified.**

Sending of faxes to multiple destinations is restricted.

**To Cancel Restriction, Change the [Restrict Sequential Broadcast] Setting.**

Log in to Remote UI in System Manager Mode ▶ [Settings/Registration] ▶ [TX Settings] ▶ [Fax TX Settings] ▶ [Edit] ▶ in [Restrict Sequential Broadcast], select [Off] ▶ [OK]

On the operation panel, select [Menu] in the [Home] screen, and then select [Function Settings] to change the setting. ▶ **[Restrict Sequential Broadcast](P. 439)**

**Cannot specify a group.**

If you press [Hook] when sending a fax, you cannot specify a group destination. Specify the destination without pressing [Hook].

You cannot specify multiple destinations or group destinations when the handset is off the hook. Return the handset, and then specify the destination.

**Cart. Comm. Error Cannot print. A non-Canon or counterfeit cartridge may be in use. Close: Press OK**

Printing cannot be performed due to incorrect installation of the toner cartridge, a damaged toner cartridge, or the use of a toner cartridge whose print quality cannot be guaranteed.

**Reinstall the Toner Cartridge or Replace with New Toner Cartridge.**

▶ **Replacing the Toner Cartridge(P. 471)**

- For optimum print quality, using Canon genuine toner cartridges is recommended. ▶ **List of Consumables(P. 478)**
- If the message still appears after repeatedly reinstalling the toner cartridge, contact your dealer or service representative. ▶ **If the Problem Persists(P. 581)**

**Cartridge Comm. Error Problems caused by non-Canon cart. not covered by warranty. Close: Press OK**

Printing cannot be performed due to incorrect installation of the toner cartridge, a damaged toner cartridge, or the use of a non-Canon toner cartridge, resulting in a communication error.

**Reinstall the Toner Cartridge.**

▶ **Replacing the Toner Cartridge(P. 471)**

- For optimum print quality, using Canon genuine toner cartridges is recommended. ▶ **List of Consumables(P. 478)**
- If the message still appears after repeatedly reinstalling the toner cartridge, contact your dealer or service representative. ▶ **If the Problem Persists(P. 581)**

**Change the authentication password.**

The password has expired.  
Set a new password.

**Check the authentication settings.**

The authentication method set on the machine does not match that set on the RADIUS server.

**Check the Authentication Method Set on the RADIUS Server, and Set This Correctly.**

▶ **Setting IEEE 802.1X(P. 312)**

**Could not connect.**

An error occurred, preventing the machine from establishing a direct connection.

**Wait a Moment, and Try Connecting Again.**

If you still cannot establish a connection, restart the machine.

**Set the IP Address for Connection to Something Other Than "192.168.22.xx".**

The machine must be restarted to apply the settings.

Log in to Remote UI in System Manager Mode ▶ [Settings/Registration] ▶ [Network Settings] ▶ [Direct Connection Settings] ▶ [Edit] ▶ in [IP Address for Direct Connection], enter the IP address ▶ [OK] ▶ restart the machine

On the operation panel, select [Menu] in the [Home] screen, and then select [Preferences] to configure the settings. ▶ **[Direct Connection Settings](P. 386)**

**Is the Subnet Mask Configured Correctly?**

Check the IPv4 subnet mask settings. Change the settings if they have not been configured correctly. For details, contact the network administrator.

▶ **Viewing the IP address set to the machine(P. 89)**

▶ **Setting IPv4 Addresses(P. 70)**

**Could not connect. Check the encryption key settings.**

The network key (encryption key) of the wireless LAN router (access point) is not configured correctly, preventing connection.

**Reset the Network Key.**

Check the network key of the wireless LAN router, and configure the settings correctly on the machine. ▶ **Connecting to a Wireless LAN(P. 54)**

**Could not connect. Max connections to access point reached**

The maximum number of devices that can be connected to the wireless LAN router (access point) has been reached, preventing connection.

**Reduce the Number of Devices (Clients) Connected to the Wireless LAN Router.**

For the maximum number of connections, see the manual of the wireless LAN router or contact the manufacturer.

## Could not connect using the wireless LAN.

An error occurred, preventing the machine from connecting to the wireless LAN.

**Restart the Machine, and Configure the Wireless LAN Connection Again.**

▶ **Connecting to a Wireless LAN(P. 54)**

**Are the Machine and Wireless LAN Router (Access Point) Located Appropriately?**

- The machine and wireless LAN router should be installed in a location without walls or other obstructions between the devices and within range of 50 m.
- Do not install near a microwave oven, digital cordless telephone, or other device that generates radio waves.

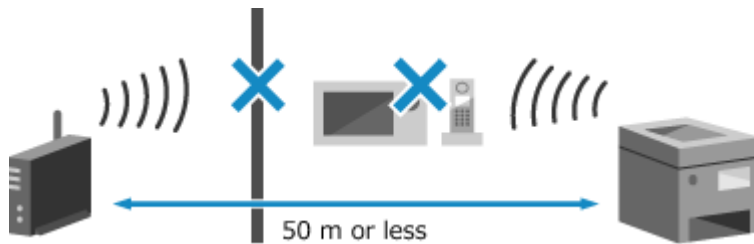

**Check the Security Settings of the Wireless LAN Router.**

For details, see the manual of the wireless LAN router or contact the manufacturer.

## Could not connect using WPS.

An error occurred, preventing the machine from establishing a WPS connection.

**Wait a Moment, and Configure the Settings Again.**

If you still cannot establish a WPS connection, check whether the wireless LAN router (access point) supports WPS.

**If It Supports WPS**

Check that the machine and wireless LAN router are located appropriately.

- The machine and wireless LAN router should be installed in a location without walls or other obstructions between the devices and within range of 50 m.
- Do not install near a microwave oven, digital cordless telephone, or other device that generates radio waves.

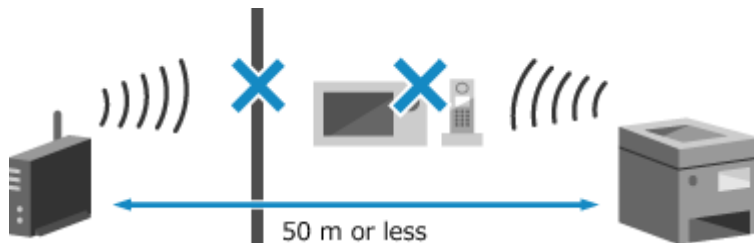

**If It Does Not Support WPS**

Connect using a different connection type. ▶ **Connecting to a Wireless LAN(P. 54)**

## Could not detect any connections from wireless devices.

An error occurred, preventing the machine from detecting mobile devices.

**Did You Connect Within the Fixed Time?**

Connect the mobile device to the machine within five minutes of the SSID and network key being displayed.

## Could not perform cleaning.

Cleaning could not be performed due to jammed paper, loading of incorrect paper, or another problem.

### **Is Paper Loaded?**

Load paper in the paper drawer if not loaded. ▶ **Loading Paper in the Paper Drawer(P. 133)**

### **Is Paper Jammed?**

If so, remove any jammed paper. ▶ **Paper Jams(P. 487)**

## Could not perform IEEE 802.1X authentication. Cannot analyze the authentication server certificate.

The certificate of the authentication server may not be correct, or it may be a format unsupported by the machine. Check the certificate of the authentication server, and change the setting, as needed.

### **Check the Certificate of the RADIUS Server, and Change the Setting, as Needed.**

▶ **Setting IEEE 802.1X(P. 312)**

## Could not perform IEEE 802.1X authentication. Change the authentication password.

The password has expired.

### **Set a New Password.**

▶ **Setting IEEE 802.1X(P. 312)**

## Could not perform IEEE 802.1X authentication. Check the authentication settings.

The authentication method set on the machine does not match that set on the RADIUS server.

### **Check the Authentication Method Set on the RADIUS Server, and Set This Correctly.**

▶ **Setting IEEE 802.1X(P. 312)**

## Could not perform IEEE 802.1X authentication. Configure the correct authentication information.

The authentication method or authentication information of IEEE 802.1X is not set correctly.

### **Set the Authentication Method and Authentication Information (Keys and Certificates, Password, CA Certificate) Correctly.**

▶ **Setting IEEE 802.1X(P. 312)**

▶ **Managing and Verifying a Key and Certificate(P. 314)**

## Could not perform IEEE 802.1X authentication. Configure the information required for authentication.

The authentication method or authentication information of IEEE 802.1X is not set correctly.

### **Set the Authentication Method and Authentication Information (Keys and Certificates, Password, CA Certificate) Correctly.**

- ▶ **Setting IEEE 802.1X(P. 312)**
- ▶ **Managing and Verifying a Key and Certificate(P. 314)**

**Could not perform IEEE 802.1X authentication. No reply from the destination.**

The network connection may have a problem.

**Check the Network Status and Settings.**

- Check the Ethernet cable and switch status.
- Check the network key of the wireless LAN router, and configure the settings correctly on the machine.

**Could not perform IEEE 802.1X authentication. The authentication server certificate has expired.**

The server certificate sent from the RADIUS server has expired.

**Check the Expiry Date of the RADIUS Server.**

- ▶ **Setting IEEE 802.1X(P. 312)**

**Could not perform IEEE 802.1X authentication. The authentication server certificate is incorrect.**

A CA certificate that supports the certificate of the authentication server is not registered to the machine.

**Check the Certificate Information of the Authentication Server, and Register a Supported CA Certificate.**

- ▶ **Setting IEEE 802.1X(P. 312)**
- ▶ **Registering a Key and Certificate or CA Certificate Obtained from an Issuing Authority(P. 320)**

**Could not perform Open System auth. Chk encryp. key set.**

The WEP authentication methods of the machine and wireless LAN router (access point) do not match, or MAC address filtering of the wireless LAN router is set to prevent a connection to the machine, thereby preventing Open System Authentication.

**Use the Manual Setup Method to Change the WEP Authentication Method to [Shared Key], and Connect Again.**

- ▶ **Connecting to a Wireless LAN by Setting the Details (Manual Setup Method)(P. 65)**

**In the MAC address filtering setting of the wireless LAN router, allow the connection to the machine.**

Check the MAC address of the machine, and configure the wireless LAN router to allow a connection from that MAC address. ▶ **Viewing the MAC Address and Connection Information of the Wireless LAN(P. 91)**  
 For the setup method, see the manual of the wireless LAN router or contact the manufacturer.

**Could not perform Shared Key auth. Chk encryp. key set.**

The network key (encryption key) of the wireless LAN router (access point) is not configured correctly, or the WEP authentication methods of the machine and wireless LAN router do not match, preventing Shared Key Authentication.

**Reset the Network Key.**

Check the network key of the wireless LAN router, and configure the settings correctly on the machine. ▶ **Connecting to a Wireless LAN(P. 54)**

**Match the WEP Authentication Method on the Machine and Wireless LAN Router.**



The machine may be set to Shared Key Authentication, and the wireless LAN router may be set to Open System Authentication. Change the WEP setting according to the authentication method you are using.

**When Using Open System Authentication**

Connect to the wireless LAN using either of the following methods:

- Connect with the access point setup method. ▶ **Connecting to a Wireless LAN by Searching for a Router (Access Point Setup Method)(P. 62)**
- Using the Manual Setup Method, connect with the WEP authentication method set to [Open System]. ▶ **Connecting to a Wireless LAN by Setting the Details (Manual Setup Method)(P. 65)**

**When Using Shared Key Authentication**

On the wireless LAN router, change the WEP authentication method to "Shared Key", and connect again. For the setup method, see the manual of the wireless LAN router or contact the manufacturer.

**Device will restart to connect using Easy Connection via PC. Is it OK?**

An error occurred, preventing the machine from connecting in Access Point Mode. Alternatively, an error occurred when starting cableless setup mode.

**Restart the Machine, and Start Cableless Setup Mode Again.**  
Administrator privileges are required.

[Home] on the operation panel ▶ [Menu] ▶ [Preferences] ▶ [Network] ▶ [Easy Connection via PC] ▶ [Yes] ▶ start the settings on the computer

**Direct Connection terminated.**

The connection with a mobile device was terminated.

**Directly Connect Again.**  
▶ **Connecting a Mobile Device Directly to the Machine (Direct Connection)(P. 288)**

**Easy Conn. via PC ended due to timeout Device will restart.**

30 minutes have elapsed since the start of the cableless setup mode without connecting to the computer.

**Restart the Machine, and Start Cableless Setup Mode Again.**  
Administrator privileges are required.

**Touch Panel Model**

[Home] on the operation panel ▶ [Menu] ▶ [Preferences] ▶ [Network] ▶ [Easy Connection via PC] ▶ [Yes] ▶ start the settings on the computer

**5 Lines LCD Model**

[Home] on the operation panel ▶ [Menu] ▶ **OK** ▶ [Preferences] ▶ **OK** ▶ [Network] ▶ **OK** ▶ [Easy Connection via PC] ▶ **OK** ▶ start the settings on the computer

**Encryption key is not set correctly. Check the encryption key settings.**

The network key (encryption key) of the wireless LAN router (access point) is not configured correctly on the machine. Alternatively, the WEP authentication method of the machine does not match that of the wireless LAN router.

**Reset the Network Key.**

Check the network key of the wireless LAN router, and configure the settings correctly on the machine. ▶  
**Connecting to a Wireless LAN(P. 54)**

**Match the WEP Authentication Method on the Machine and Wireless LAN Router.**

The machine may be set to Shared Key Authentication, and the wireless LAN router may be set to Open System Authentication. Change the WEP setting according to the authentication method you are using.

**When Using Open System Authentication**

Connect to the wireless LAN using either of the following methods:

- Connect with the access point setup method. ▶**Connecting to a Wireless LAN by Searching for a Router (Access Point Setup Method)(P. 62)**
- Using the Manual Setup Method, connect with the WEP authentication method set to [Open System]. ▶  
**Connecting to a Wireless LAN by Setting the Details (Manual Setup Method)(P. 65)**

**When Using Shared Key Authentication**

On the wireless LAN router, change the WEP authentication method to "Shared Key", and connect again. For the setup method, see the manual of the wireless LAN router or contact the manufacturer.

**End of Cart. Lifetime**

The toner cartridge has reached the end of their lifetime.

**It Is Recommended to Replace with New Toner Cartridge.**  
 Replace the toner cartridge. ▶**Replacing the Toner Cartridge(P. 471)**

**IEEE 802.1X error. Cannot analyze auth. server certificate.**

The certificate of the authentication server may not be correct, or it may be a format unsupported by the machine. Check the certificate of the authentication server, and change the setting, as needed.

**Check the Certificate of the RADIUS Server, and Change the Setting, as Needed.**  
 ▶ **Setting IEEE 802.1X(P. 312)**

**IEEE 802.1X error. The auth. server cert. has expired.**

The server certificate sent from the RADIUS server has expired.

**Check the Expiry Date of the RADIUS Server.**  
 ▶ **Setting IEEE 802.1X(P. 312)**

**IEEE 802.1X error. The auth. server cert. is incorrect.**

A CA certificate that supports the certificate of the authentication server is not registered to the machine.

**Check the Certificate Information of the Authentication Server, and Register a Supported CA Certificate.**  
 ▶ **Setting IEEE 802.1X(P. 312)**  
 ▶ **Registering a Key and Certificate or CA Certificate Obtained from an Issuing Authority(P. 320)**

**IEEE 802.1X error. Change the auth. password.**

The password has expired.

**Set a New Password.**  
 ▶ **Setting IEEE 802.1X(P. 312)**

## IEEE 802.1X error. Check the auth. settings.

The authentication method set on the machine does not match that set on the RADIUS server.

**Check the Authentication Method Set on the RADIUS Server, and Set This Correctly.**

▶ **Setting IEEE 802.1X(P. 312)**

## IEEE 802.1X error. Configure correct authentication info.

The authentication method or authentication information of IEEE 802.1X is not set correctly.

**Set the Authentication Method and Authentication Information (Keys and Certificates, Password, CA Certificate) Correctly.**

▶ **Setting IEEE 802.1X(P. 312)**

▶ **Managing and Verifying a Key and Certificate(P. 314)**

## IEEE 802.1X error. Configure the info. required for auth.

The authentication method or authentication information of IEEE 802.1X is not set correctly.

**Set the Authentication Method and Authentication Information (Keys and Certificates, Password, CA Certificate) Correctly.**

▶ **Setting IEEE 802.1X(P. 312)**

▶ **Managing and Verifying a Key and Certificate(P. 314)**

## IEEE 802.1X error. No reply from the destination.

The network connection may have a problem.

**Check the Network Status and Settings.**

- Check the Ethernet cable and switch status.
- Check the network key of the wireless LAN router, and configure the settings correctly on the machine.

## Incorrect number of characters/invalid characters entered.

The network key of the wireless LAN router (access point) is not configured correctly on the machine.

**Reset the Network Key.**

Check the network key of the wireless LAN router, and configure the settings correctly on the machine. ▶ **Connecting to a Wireless LAN(P. 54)**

## Low Cartridge Level

It is nearing the time to replace the toner cartridge.

**Prepare New Toner Cartridge, and Replace the Old Ones, as Needed.**

When printing large printing jobs, it is recommended to replace the toner cartridge. ▶ **Replacing the Toner Cartridge(P. 471)**

**To Continue Printing, Press [Continue Printing].**

**When Faxing, or Printing an Auto Report**

In the following cases, the data may be saved to the memory of the machine without being printed to prevent printing text that is difficult to read or images that are difficult to see:

- When receiving a Fax

- When communication results reports are set to be printed automatically  
To continue printing, enable [Continue Printing When Amount in Cartridge Is Low].

Log in to Remote UI ▶ [Settings/Registration] ▶ [RX/Forwarding Settings] or [RX Settings] ▶ [Common Settings] ▶ [Edit] in [Common Settings] ▶ select the [Continue Printing When Amount in Cartridge Is Low] checkbox ▶ [OK]

On the operation panel, select [Menu] in the [Home] screen, and then select [Function Settings] to configure the settings. ▶[Displ. Timing for Cartridge Prep. Notif.](P. 381)

\* When this setting is enabled, the printing results may be light or faded.

## NOTE

- You can manually specify when this message appears (when toner is low). ▶[Displ. Timing for Cartridge Prep. Notif.](P. 381)

## Mem. Full (Skip Error)

The memory is full with data that has not been printed due to an error.

**Cancel Printing of the Data with an Error, or Press [Skip Error] on the [Status Monitor] Screen.**

▶**Canceling Printing with the Operation Panel(P. 188)**

▶**Viewing the Print Job Status and Log(P. 190)**

## Memory is full.

Faxing cannot be performed due to insufficient available memory. If there is data waiting to be printed or sent, wait until the processing is completed.

**Check the Received Faxes Saved in the Memory.**

Print or forward them as needed, and delete any unnecessary faxes. ▶**Viewing and Printing Faxes Saved in the Memory(P. 332)**

**When Sending Faxes, Divide the Original or Lower the Resolution.**

- When sending an original with many pages, divide the original and send it.
- Change the set resolution to a lower resolution when scanning the original.

## No reply from the destination.

The Ethernet cable may not be connected or there may be a problem with the switch. Check the Ethernet cable and switch status.

## No response from host.

The machine is not connected correctly to the network.

**Check the Settings of the Machine and Network, and Connect Again.**

**When Connected via Wireless LAN**

Configure the settings correctly according to your usage environment. ▶**Connecting to a Wireless LAN(P. 54)**

**When Connected via Wired LAN**

Check that the Ethernet cable is properly connected. ▶**Connecting to a Wired LAN(P. 53)**

## Paper jammed.

Paper jammed in the machine during printing.

**Remove the Jammed Paper, and If Printing Does Not Resume Automatically, Try Printing Again.**

▶ **Paper Jams(P. 487)**

## Prepare a cartridge.

It is nearing the time to replace the toner cartridge.

**Prepare New Toner Cartridge, and Replace the Old Ones, as Needed.**

When printing large jobs, it is recommended to replace the toner cartridge. ▶ **Replacing the Toner Cartridge(P. 471)**

**To Continue Printing, Use the Procedure Below.**

### When Faxing, or Printing an Auto Report

In the following cases, the data may be saved to the memory of the machine without being printed to prevent printing text that is difficult to read or images that are difficult to see:

- When receiving a Fax
- When communication results reports are set to be printed automatically

To continue printing, enable [Continue Printing When Amount in Cartridge Is Low].

Log in to Remote UI ▶ [Settings/Registration] ▶ [RX/Forwarding Settings] or [RX Settings] ▶ [Common Settings] ▶ [Edit] in [Common Settings] ▶ select the [Continue Printing When Amount in Cartridge Is Low] checkbox ▶ [OK]

On the operation panel, select [Menu] in the [Home] screen, and then select [Function Settings] to configure the settings. ▶ **[Displ. Timing for Cartridge Prep. Notif.](P. 381)**

\* When this setting is enabled, the printing results may be light or faded.

## NOTE

- You can manually specify when this message appears (when toner is low). ▶ **[Displ. Timing for Cartridge Prep. Notif.](P. 381)**

## Set the correct authentication information.

The authentication method or authentication information of IEEE 802.1X is not set correctly.

**Set the Authentication Method and Authentication Information (Keys and Certificates, Password, CA Certificate) Correctly.**

▶ **Setting IEEE 802.1X(P. 312)**

▶ **Managing and Verifying a Key and Certificate(P. 314)**

## Set the information necessary for authentication.

The authentication method or authentication information of IEEE 802.1X is not set correctly.

**Set the Authentication Method and Authentication Information (Keys and Certificates, Password, CA Certificate) Correctly.**

▶ **Setting IEEE 802.1X(P. 312)**

▶ **Managing and Verifying a Key and Certificate(P. 314)**

## Size/Settings Mismatch

The size of the paper loaded in the machine does not match that set on the operation panel or printer driver.

### Match the Size of the Loaded Paper with the Paper Size Setting.

#### When Using the Loaded Paper

- Change the paper size setting on the operation panel to match the size of the loaded paper.
  - ▶ **Setting the Paper Size and Type for the Paper Drawer(P. 140)**
- When printing from a computer, change the paper size setting on the printer driver to match the size of the loaded paper. ▶ **Printing from a Computer(P. 182)**

#### When Reloading Paper

Load paper of this size set on the operation panel or printer driver. ▶ **Loading Paper(P. 132)**

### Check That the Paper Guides Are Not Too Loose or Too Tight.

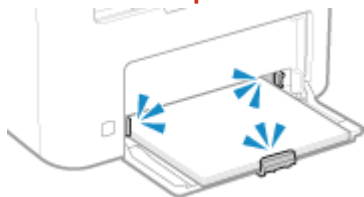

## Specifying and registering new destinations is restricted.

Destinations that can be specified for sending are restricted to those destinations registered in the Address Book.

### To Cancel Restriction, Change the [Restrict New Destinations] Setting.

Log in to Remote UI in System Manager Mode ▶ [Settings/Registration] ▶ [TX Settings] ▶ [Restrict New Destinations] ▶ [Edit] ▶ clear the [Restrict New Destinations] checkbox ▶ [OK]

On the operation panel, select [Menu] in the [Home] screen, and then select [Function Settings] to change the setting. ▶ **[Restrict New Destinations](P. 431)**

## The authentication server certificate has expired.

The server certificate sent from the RADIUS server has expired.

### Check the Expiry Date of the RADIUS Server.

- ▶ **Setting IEEE 802.1X(P. 312)**

## The authentication server certificate is incorrect.

A CA certificate that supports the certificate of the authentication server is not registered to the machine.

### Check the certificate information of the authentication server, and register a supported CA certificate.

- ▶ **Setting IEEE 802.1X(P. 312)**
- ▶ **Registering a Key and Certificate or CA Certificate Obtained from an Issuing Authority(P. 320)**

## The fax number has too many digits.

Sending of a fax cannot be performed because the specified fax number has too many digits.

### Specify a Fax Number That Does Not Exceed the Maximum Number of Digits to Send a Fax.

If the settings are configured to send a fax after entering a designated number before you specify a destination registered in the Address Book, the maximum number of digits to send a fax may be exceeded.

➤ **[Use Address Book When On-Hook](P. 438)**

## The memory is full. Scanning will be canceled. Print?

Reading of the original cannot be performed due to insufficient available memory. Alternatively, all the pages could not be read when sorting and copying.

**Divide the Original Before Copying.**

Print up to the pages that were read or cancel the job, and then divide the original before copying.

**Try Configuring the Setting as Follows.**

**Touch Panel Model**

[Home] screen on the operation panel ▶ [Copy] ▶ [Original Type] ▶ [Text/Photo (High Speed)].

**5 Lines LCD Model**

[Home] screen on the operation panel ▶ [Copy] ▶ **OK** ▶ [Original Type] ▶ **OK** ▶ [Text/Photo (High Speed)].

## Use Remote UI to set info. necessary for authentication.

The authentication method or authentication information of IEEE 802.1X is not set correctly.

**Check the IEEE 802.1X Setting, and Set This Correctly.**

Check the following, and change the setting, as needed. ➤ **Setting IEEE 802.1X(P. 312)**

- The login name is specified correctly.
- At least one of the following checkboxes is selected: [Use TLS], [Use TTLS], and [Use PEAP].
- When using TLS, a key and certificate are registered.
- When using TTLS or PEAP, the user name and password are set correctly.

# An Error Code Is Displayed

94WS-0HH

If printing cannot be performed, or a fax cannot be sent or received, or another error occurs, an error code (three-digit number starting with "#") is displayed in the report or job log.

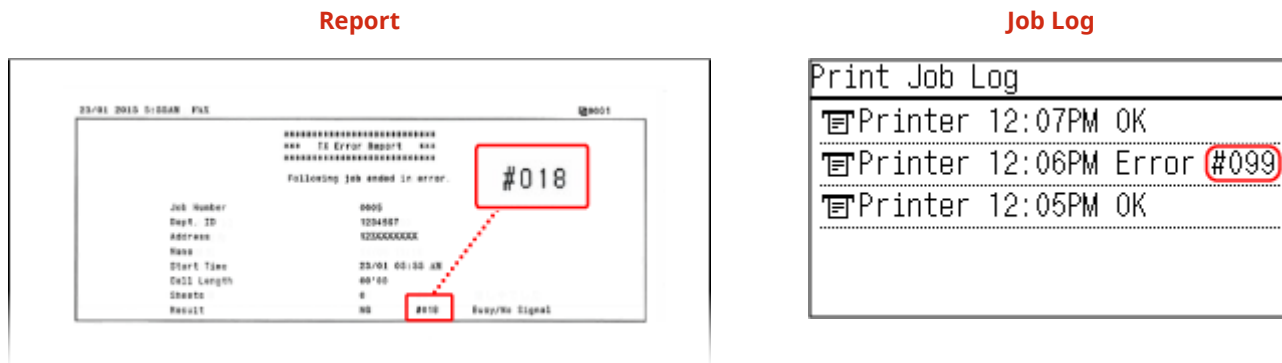

Select the error code from the list below, and check how to troubleshoot the problem.

**#001 to #099**

- ▶ #001(P. 575)   ▶ #003(P. 575)   ▶ #005(P. 576)   ▶ #012(P. 576)   ▶ #018(P. 576)   ▶ #022(P. 576)   ▶ #037(P. 577)   ▶ #099(P. 577)

**#701 to #799**

- ▶ #703(P. 577)   ▶ #751(P. 578)   ▶ #753(P. 578)   ▶ #755(P. 578)   ▶ #766(P. 578)

**#801 to #899**

- ▶ #818(P. 579)   ▶ #819(P. 579)   ▶ #820(P. 579)   ▶ #821(P. 579)   ▶ #827(P. 579)   ▶ #829(P. 579)   ▶ #852(P. 579)   ▶ #853(P. 579)   ▶ #861(P. 580)   ▶ #863(P. 580)

**#901 to #999**

- ▶ #934(P. 580)   ▶ #995(P. 580)

## NOTE

- If the problem persists even after trying the troubleshooting methods, contact your dealer or service representative. ▶ **If the Problem Persists(P. 581)**

### #001

The original is jammed in the feeder.

**Remove the Jammed Original.**

- ▶ **Paper Jams in the Feeder(P. 493)**

### #003

The data volume is too large to send or receive a fax.

**Divide the Original or Lower the Resolution.**

**Cannot Send a Fax**

- When sending an original with many pages, divide the original and send it.



- Change the set resolution to a lower resolution when scanning the original.

[Home] screen on the operation panel ▶ [Fax] ▶ [Resolution] ▶ select the resolution.

### Cannot Receive a Fax

Ask the sender to divide the original or lower the resolution and send the fax again.

## #005

There was no response from the other party's device within the time limit.

#### Did You Specify an Overseas Destination?

You may not have been able to connect correctly to the destination. After entering the international access number or country code, enter the wait time (pause) or lower the communication start speed before sending the fax. **▶ Cannot Send a Fax to an International Destination(P. 553)**

#### Is the Other Party's Device Ready to Receive a Fax?

The power of the other party's device may not be turned on, or the RX Mode may not be configured correctly. Have the other party check these.

## #012

The receiving device is out of paper (recording paper).  
Have the other party add more paper.

## #018

There was no response from the other party's device due to it being busy or another reason.

#### Did You Specify an Overseas Destination?

You may not have been able to connect correctly to the destination. After entering the international access number or country code, enter the wait time (pause) or lower the communication start speed before sending the fax. **▶ Cannot Send a Fax to an International Destination(P. 553)**

#### Is the Other Party's Device Ready to Receive a Fax?

The power of the other party's device may not be turned on, or the RX Mode may not be configured correctly. Have the other party check these.

## #022

Sending of faxes from a computer is restricted. Alternatively, the destination specified as the forwarding destination may have been deleted from the Address Book.

#### To Cancel Restriction of Sending Faxes from a Computer, Change the [Fax TX Settings] Setting.

Log in to Remote UI in System Manager Mode ▶ [Settings/Registration] ▶ [TX Settings] ▶ [Fax TX Settings] ▶ [Edit] ▶ select the [Allow Fax Driver TX] checkbox ▶ [OK]

On the operation panel, select [Menu] in the [Home] screen, and then select [Function Settings] to change the setting. **▶ [Allow Fax Driver TX](P. 438)**

#### Register the Forwarding Destination to the Address Book.

**▶ Registering Destinations to the Address Book (Remote UI) (Touch Panel Model)(P. 155)**

#### Check Whether the Fax That Could Not Be Forwarded Is Saved in the Memory.

If the fax is saved in the memory, you can try forwarding it again. **▶ Checking Faxes that Failed to Be Forwarded(P. 237)**

**#037**

Sending of a fax failed due to insufficient available memory or the maximum number of destinations to which a fax can be sent was exceeded. Alternatively, printing could not be performed due to the file size. If there is data waiting to be printed or sent by fax, wait until the processing is completed.

**Check Received Data Saved to the Memory.**

Print or forward them as needed, and delete any unnecessary data.

▶ **Viewing and Printing Faxes Saved in the Memory(P. 332)**

▶ **Checking Faxes that Failed to Be Forwarded(P. 237)**

**When Sending Faxes, Divide the Original or Lower the Resolution.**



- When sending an original with many pages, divide the original and send it.
- Change the set resolution to a lower resolution when scanning the original.

[Home] screen on the operation panel ▶ [Fax] ▶ [Resolution] ▶ select the resolution.

**When Sending a Fax Using Windows, Are You Trying to Send the Fax to Multiple Destinations?**

Sending of the fax may have failed due to the maximum number of destinations that can be specified at a time was exceeded.

Use the following procedure to change the fax driver setting and increase the number of destinations that can be specified at a time.

- 1 Log on to the computer using an administrator account.
- 2 [  ] (Start) ▶ [  ] (Settings) ▶ [Devices] ▶ click [Printers & scanners]  
 ▶▶ The [Printers & scanners] screen is displayed.
- 3 Select the fax driver of the machine ▶ [Manage] ▶ click [Printer properties]  
 ▶▶ The fax driver properties screen is displayed.
- 4 On the [Device Settings] tab, select the [Set the number of destinations that can be specified at once to 2000] checkbox.
- 5 Click [OK].

**Reduce the File Size or Divide the File.**

Optimize the file to make it smaller, or divide the file and then print it.

**#099**

The job was canceled.

This does not indicate a malfunction. Perform the operation again, as needed.

**#703**

The machine does not have sufficient free memory.

**Is Any Other Data Being Sent?**

Wait for sending to be completed before sending again.

**Are You Sending an Original with Many Pages?**

Divide the original and send it.

**Check the Received Faxes Saved in the Memory.**

Print or forward them as needed, and delete any unnecessary faxes. ▶ **Viewing and Printing Faxes Saved in the Memory(P. 332)**

**Restart the Machine, and Then Send or Save the Data Again.**

▶ **Restarting the Machine(P. 106)**

## #751

The machine was unable to connect to the network due to a disconnection.

### Check the Network Status and Settings.

If the machine is not connected to a network, reconfigure the network settings.

- ▶ **Checking the Network Status and Settings(P. 88)**
- ▶ **Setting Up the Network(P. 49)**

## #753

The machine was unable to connect to the network due to a disconnected Ethernet cable.

### Check That the Ethernet Cable Is Properly Connected.

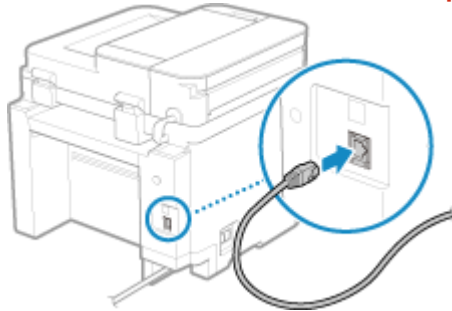

## #755

The TCP/IP is not configured correctly, or the machine was unable to connect to the network due to the set wait time before connection.

### Check the Network Status and Settings.

If the machine is not connected to a network, reconfigure the network settings.

- ▶ **Checking the Network Status and Settings(P. 88)**
- ▶ **Setting Up the Network(P. 49)**

### Is There a Set Wait Time Before Connection?

Check whether a wait time is set.

Log in to Remote UI in System Manager Mode ▶ [Settings/Registration] ▶ [Network Settings] ▶ [Waiting Time for Connection at Startup]

On the operation panel, select [Menu] in the [Home] screen, and then select [Preferences] to view this information. ▶ **[Waiting Time for Connection at Startup](P. 388)**

- If a wait time is set, a connection cannot be established immediately after turning ON the power of the machine. Sending starts after the wait time has elapsed.
- To change the wait time, click [Edit] on the above [Waiting Time for Connection at Startup] screen, enter the wait time, and then click [OK].

## #766

The certificate has expired.

### Renew the certificate, or use a certificate that is not expired.

- ▶ **Managing and Verifying a Key and Certificate(P. 314)**

### Are the current date and time on the machine correct?

Check the date and time settings. If the settings are not correct, set the time zone, and then set the current date and time. ▶ **Setting the Date and Time(P. 347)**

## #818

The received data is in a format that cannot be printed.  
Have the sender change the file format and resend the file.

## #819

The received data has invalid MIME information and cannot be processed.  
Have the sender check the settings and resend the data.

## #820

The received data has invalid BASE64 or uuencode data and cannot be processed.  
Have the sender check the settings and resend the data.

## #821

The received data has a TIFF analysis error and cannot be processed.  
Have the sender check the settings and resend the data.

## #827

The received data includes unsupported MIME information and cannot be processed.  
Have the sender check the settings and resend the data.

## #829

The received data exceeds the maximum size that can be received by the machine.

### **Have the Sender Check and Resend the Data.**

#### **When Receiving a Fax**

The machine prints or saves to memory pages 1 to 999 and deletes page 1,000 and beyond. Have the sender resend page 1,000 and beyond.

## #852

The power of the machine turned OFF for some reason.  
Make sure the power plug is firmly inserted into an outlet.

## #853

Printing failed for some reason.  
If the operation was canceled when print data was being sent from a computer to the machine, try printing again.  
Otherwise, check the following:

#### **Are You Printing a Large Job?**

The data volume may have exceeded the processing capacity of the machine. Reduce the number of pages to print, or print when there is no print data being printed or waiting to be printed.

#### **Is the Data to Be Printed Corrupted?**

If the data is corrupted or otherwise damaged, fix the data.

## #861

You are using an unsupported printer driver, or the data you are trying to print is corrupted.

**Use the printer driver of the machine, and try printing again.**

▶ **Printing from a Computer(P. 182)**

**Is the Data to Be Printed Corrupted?**

If the data is corrupted or otherwise damaged, fix the data.

## #863

An error occurred, preventing printing.

**Restart the Machine, and Then Print the Data Again.**

▶ **Restarting the Machine(P. 106)**

## #934

The job was deleted by the Auto Delete Suspended Jobs function.

**Resolve the Error That Caused the Job to Be Suspended.**

Resolve the error, and try printing or copying again.

\* Disable the Auto Delete Suspended Jobs function, or change the time until the data is automatically deleted. ▶ **[Auto Delete Suspended Jobs](P. 417)**

## #995

Sending or receiving of a waiting job was canceled.  
Try sending or receiving again, as needed.

## If the Problem Persists

94WS-0HJ

If the problem persists even after trying the troubleshooting methods, contact your dealer or service representative.

### **IMPORTANT**

**Do not disassemble or repair the machine yourself.**

- Disassembling or repairing the machine yourself may void the warranty.

### Checks Before Contacting Us



- Product name (MF275dw / MF272dw)
- Dealer purchased from
- Details of the problem (such as operation details and their results)
- Serial number

#### How to Look Up the Serial Number

##### Touch Panel Model

 on the operation panel ▶ [Device Status] ▶ [Serial Number]

##### 5 Lines LCD Model

[Home] screen on the operation panel ▶ [Status Monitor] ▶  ▶ [Device Status] ▶  ▶ [Serial Number] ▶ 

- You can also check this information using Remote UI from a computer.  **Managing the Machine from a Computer (Remote UI)(P. 348)**
- You can also check this information on the label on the back of the machine.

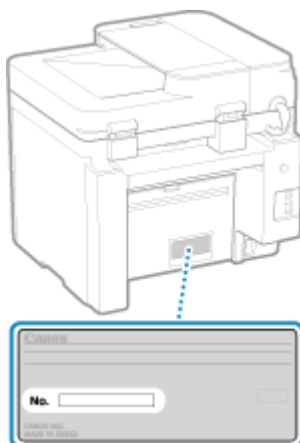

# Appendix

<b>Appendix</b> .....	583
<b>Manuals of the Machine</b> .....	584
<b>Using the User's Guide</b> .....	585
<b>Manual Display Settings</b> .....	588
<b>Operation Examples When Using a Computer</b> .....	589
<b>Environmental Information, Regulations, and Standards</b> .....	599
<b>Notice</b> .....	601
<b>Trademarks and Copyrights</b> .....	602
<b>Third-party Software</b> .....	604

# Appendix

---

94WS-0HK

In this chapter, you can view the manuals of the machine and the basic operations required when using the machine with a computer.

## Manuals of the Machine

Manuals are provided according to your purpose.

### ▶ Manuals of the Machine(P. 584)

The User's Guide (this manual) contains information on all functions of the machine and specifications as well as how to maintain the machine. You can search for specific information and change the text size and layout.

### ▶ Using the User's Guide(P. 585)

### ▶ Manual Display Settings(P. 588)

## Basic Operations When Using with a Computer

You must set up a computer to use the machine from the computer and view information set on the machine from the computer. The operations are introduced using Windows and macOS operation examples.

### ▶ Operation Examples When Using a Computer(P. 589)

## Other Information

### ▶ Environmental Information, Regulations, and Standards(P. 599)

### ▶ Notice(P. 601)

### ▶ Trademarks and Copyrights(P. 602)

### ▶ Third-party Software(P. 604)



# Manuals of the Machine

---

94WS-0HL

The manuals below are provided with the machine. Use these according to your purpose. Click on the icon to display the corresponding manual (PDF).

### Important Safety Instructions

This contains required information to prevent injury and accidental damage to property.



### Setup Guide

This explains the process from unpacking the machine to setting it up so that it is ready to use.



### User's Guide (this manual)

This describes all the functions of the machine in detail. It also contains the specifications and describes how to maintain the machine. The User's Guide is displayed in a Web browser.

▶ **Using the User's Guide(P. 585)**

## NOTE

- For information on drivers, and software manuals, see the online manual site.  
<https://oip.manual.canon/>

# Using the User's Guide

94WS-0HR

The User's Guide (this manual) contains information on all functions of the machine and specifications as well as how to maintain the machine.

You can use the User's Guide to find useful information through the contents and search function.

\* Click [☰] or [🔍] at the top of the screen to change between contents and search keyword display.

▶ **Screens and Illustrations(P. 585)**

▶ **Symbols(P. 585)**

▶ **Key and Button Indicators(P. 586)**

▶ **Search Function(P. 586)**

▶ **Operating Environment(P. 587)**

## NOTE

- The User's Guide describes the various functions of all model series including the machine. You can view a table indicating which functions and options are supported for each model. ▶ **Supported Functions and Options(P. 3)**

## Screens and Illustrations

In the User's Guide, unless otherwise stated, the following are used in the screens and illustrations.

### Model

MF275dw

### Toner Cartridges

Canon Cartridge 071

### Computer Operating System

Windows 10

macOS 11

- The screens may vary depending on the model.
- The operations and screens may vary depending on the computer operating system.
- The screens are subject to change due to updates of the drivers and software.

## Symbols

The warnings and cautions are also listed in the Important Safety Instructions supplied with the machine. See this for more information. ▶ **Manuals of the Machine(P. 584)**



**WARNING**

Indicates a warning concerning operations that may lead to death or serious personal injury if not performed correctly. To ensure that you use the machine safely, always observe these warnings.



**CAUTION**

Indicates a precaution for preventing the risk of personal injury or property damage other than a product fault due to improper use of the machine. To ensure that you use the machine safely, always observe these cautions.



Indicates an operation that must not be performed. Read these items carefully, and make sure not to perform the described operations.



## IMPORTANT

Indicates important requirements and restrictions for security and data protection as well as precautions that should be observed. Be sure to read these items to avoid malfunction, fault, or property damage due to incorrect operation.

## NOTE

Indicates a clarification of an operation, or contains additional explanations for a procedure.

## Key and Button Indicators

The operation panel keys and buttons displayed on the screen are indicated as follows:

### Operation Panel Keys

Indicated with an icon.

**Example:** Back key



### Buttons Displayed on the Operation Panel and Computer Screen

Enclosed in square brackets [ ].

**Example:**

[Menu]

[Cancel] ► [Yes]

[Settings applied.]

## Search Function



### 1 Click [ ] at the top of the screen.

⇒ The search keyword input field is displayed at the top left of the screen.

### 2 Enter a keyword, and click [ ] or press the [Enter] key on the computer.

- Separate multiple keywords with spaces to search for pages that include all keywords.
- Enclose keywords in double quotation marks ("") to search for pages that only contain complete matches including spaces.

### 3 Click the search result to view the page.

- Click [  ] to show or hide the search results.
- Click [  ] to display the contents.

## Operating Environment

The User's Guide can be viewed in the following operating environments:

### **Windows**

Internet Explorer 9 or later

Microsoft Edge

Firefox

Firefox ESR

Chrome<sup>\*1</sup>

### **macOS**

Safari

Firefox

Chrome<sup>\*1</sup>

### **Linux**

Firefox

### **iOS**

Safari<sup>\*1</sup>

### **Android**

Chrome<sup>\*1</sup>

<sup>\*1</sup> Only available when viewing at the online manual site.

# Manual Display Settings

---

94WS-0HS

# Operation Examples When Using a Computer

94WS-0HU

When using the machine from a computer, you must configure the settings of the computer according to the function you are using. In addition, you may need the computer information to view the information set on the machine. In this case, use the operation examples below to check the required settings and information on the computer.

- ▶ **Creating a Shared Folder(P. 589)**
- ▶ **Enabling Network Discovery(P. 591)**
- ▶ **Displaying a Shared Printer in the Print Server(P. 591)**
- ▶ **Viewing the System Information of the Computer(P. 592)**
- ▶ **Viewing the Network Connection Information of the Computer(P. 594)**
- ▶ **Viewing the Printer Port(P. 596)**
- ▶ **Viewing Two-way Communication(P. 597)**
- ▶ **Printing a Test Page(P. 597)**

## Creating a Shared Folder

- ▶ **When Using Windows(P. 589)**
- ▶ **When Using macOS(P. 590)**

### ■ When Using Windows

#### 1 Create a folder in any location (such as Desktop).

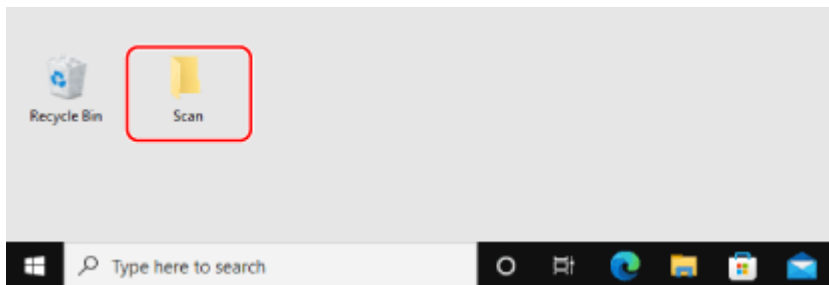

#### 2 Right-click the created folder, and click [Properties].

#### 3 On the [Sharing] tab, click [Advanced Sharing].

⇒ The [Advanced Sharing] screen is displayed.

#### 4 Select the [Share this folder] checkbox, and click [Permissions].

#### 5 Configure the access privilege.

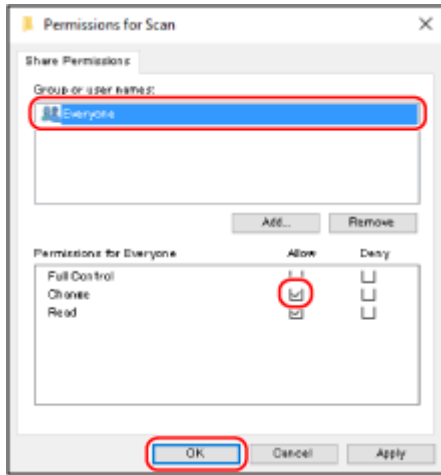

- 1 In [Group or user names], select [Everyone].
- 2 In [Permissions], select the [Allow] checkbox in [Change].
- 3 Click [OK].

## 6 Click [OK] ► [Close].

► The created folder can be used as a shared folder.

### ■ When Using macOS

## 1 Click [Apple] ► [System Preferences] ► [Sharing].

► The [Sharing] screen is displayed.

## 2 Select the [File Sharing] checkbox, and click [+] in [Shared Folders].

## 3 Create a folder in any location (such as Desktop), and click [Add].

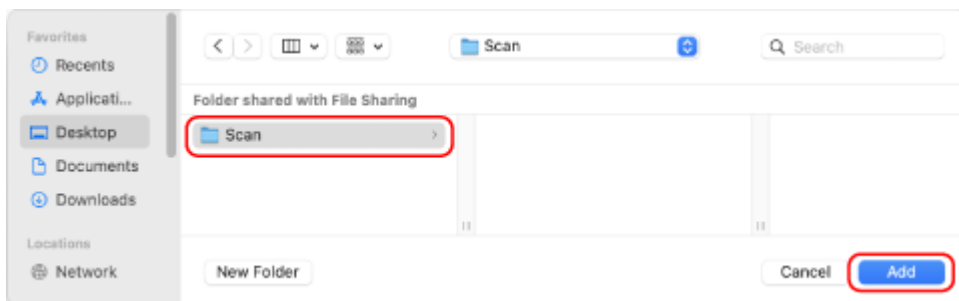

## 4 Configure the access privilege.

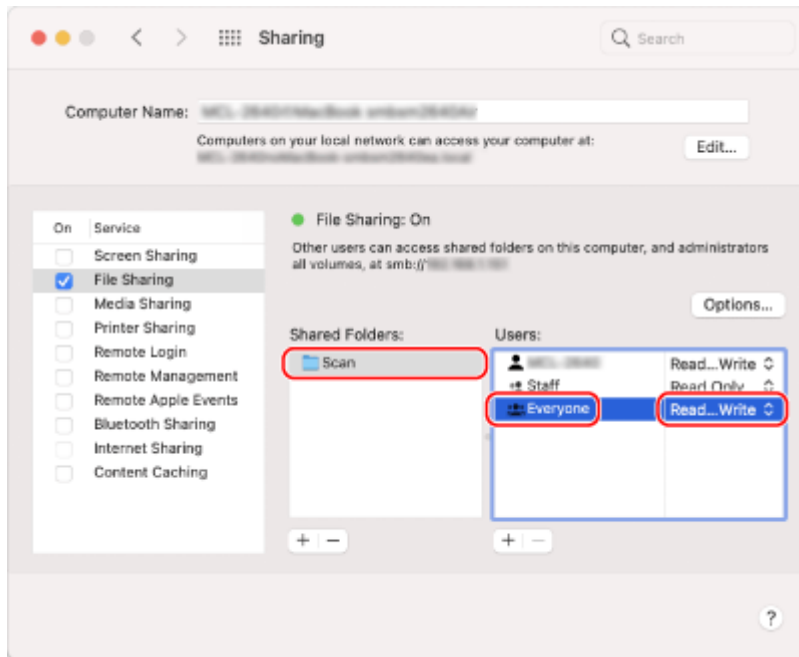

- 1 In [Shared Folders], select the created folder.
- 2 In [Users], select [Everyone] ► [Read & Write].

## 5 Close the screen.

►► The created folder can be used as a shared folder.

## Enabling Network Discovery

### 1 Right-click [⊞] (Start), and click [Network Connections].

►► The [Status] screen is displayed.

### 2 Click [Network and Sharing Center] ► [Change advanced sharing settings].

►► The [Advanced sharing settings] screen is displayed.

### 3 In [Network discovery], select [Turn on network discovery], and click [Save changes].

## Displaying a Shared Printer in the Print Server

- When Using Windows(P. 592)
- When Using macOS(P. 592)



## ■ When Using Windows

- 1 Right-click [⊞] (Start), and click [File Explorer].
- 2 In [Network], select the print server to display the shared printer.

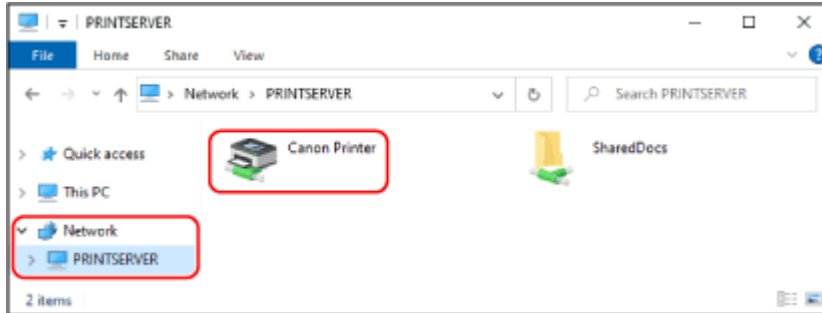

If nothing is displayed in [Network], enable network discovery. ▶ [Enabling Network Discovery\(P. 591\)](#)

## ■ When Using macOS

- 1 Click [🍏] ▶ [System Preferences] ▶ [Printers & Scanners].
  - ⇒ The [Printers & Scanners] screen is displayed.
- 2 Click [+] at the bottom left.
  - ⇒ The [Add] screen is displayed.
- 3 Click [🖨️], to display the shared printer.

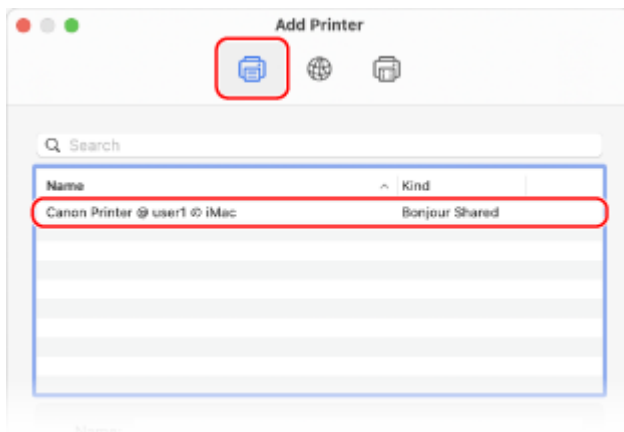

## Viewing the System Information of the Computer

- ▶ [When Using Windows\(P. 593\)](#)
- ▶ [When Using macOS\(P. 593\)](#)

## ■ When Using Windows

### 1 Right-click [Start] (Windows logo), and click [System].

⇒ The [About] screen is displayed.

### 2 In [Device specifications], view the computer name and operating system version.

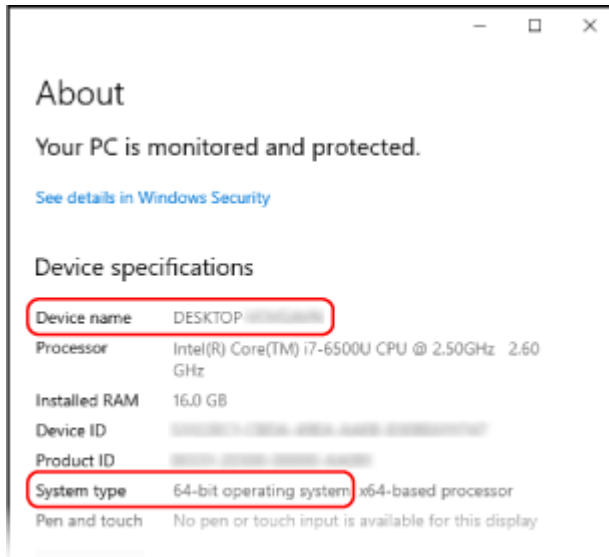

- The computer name is displayed in [Device name].
- The operating system version is displayed in [System type].  
If the computer has a 32-bit operating system, "32-bit Operating System" is displayed.  
If the computer has a 64-bit operating system, "64-bit Operating System" is displayed.

## ■ When Using macOS

### 1 Click [Apple logo] ▶ [System Preferences] ▶ [Sharing].

⇒ The [Sharing] screen is displayed.

The name displayed in [Computer Name] on the [Sharing] screen may not be usable on the network. Use the following procedure to view the computer name used on the network.

### 2 Click [Edit].

### 3 In [Local Hostname], view the computer name.

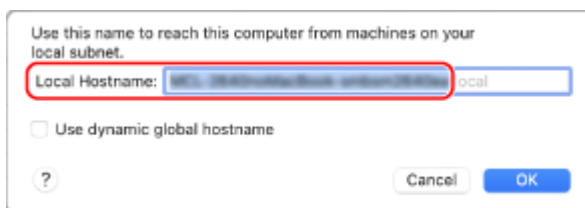

Parts displayed in gray are not included in the computer name.

## 4 Click [Cancel].

### Viewing the Network Connection Information of the Computer

▶ When Using Windows(P. 594)

▶ When Using macOS(P. 595)

#### ■ When Using Windows

## 1 Right-click [ ] (Start), and click [Network Connections].

⇒ The [Status] screen is displayed.

## 2 View the network connection information.

### ■ Viewing the SSID of the Wired LAN

View the SSID in [Network status].

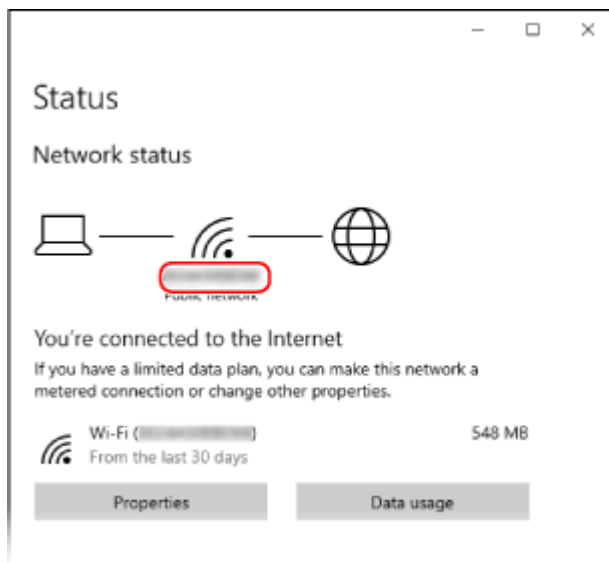

### ■ Viewing the IP Address and DNS Server

- 1 Click [Properties] for the connected network.
- 2 In [Properties], view the IP address and DNS server.

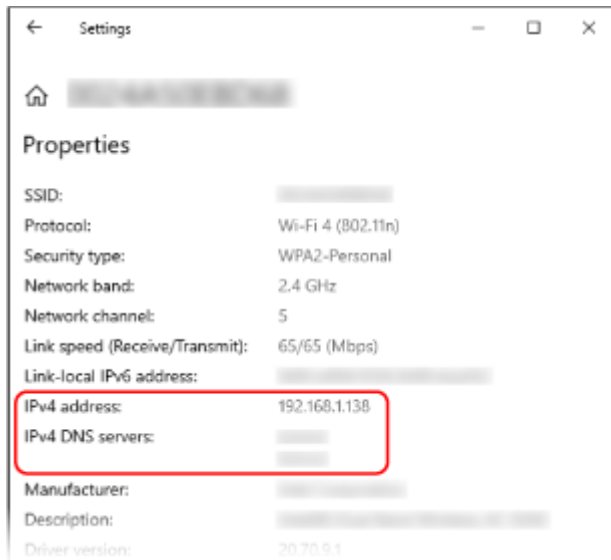

## ■ When Using macOS

**1** Click [🍏] ► [System Preferences] ► [Network].

⇒ The [Network] screen is displayed.

**2** View the IP address, DNS server, and other information.

### ■ For Wired LAN

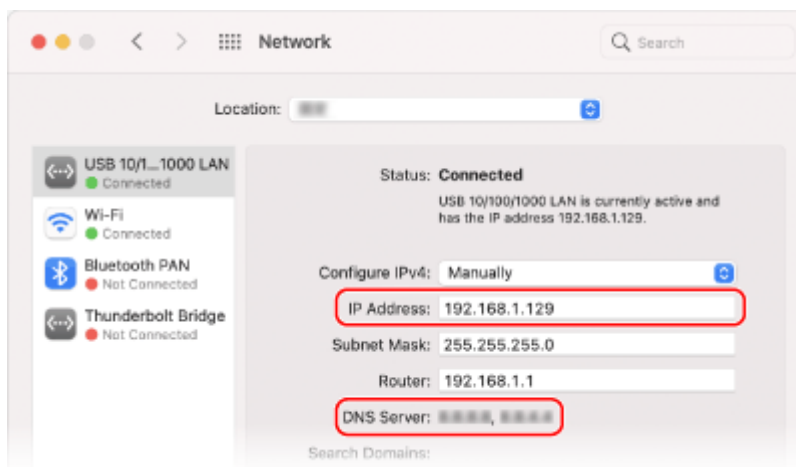

## ■ For Wireless LAN

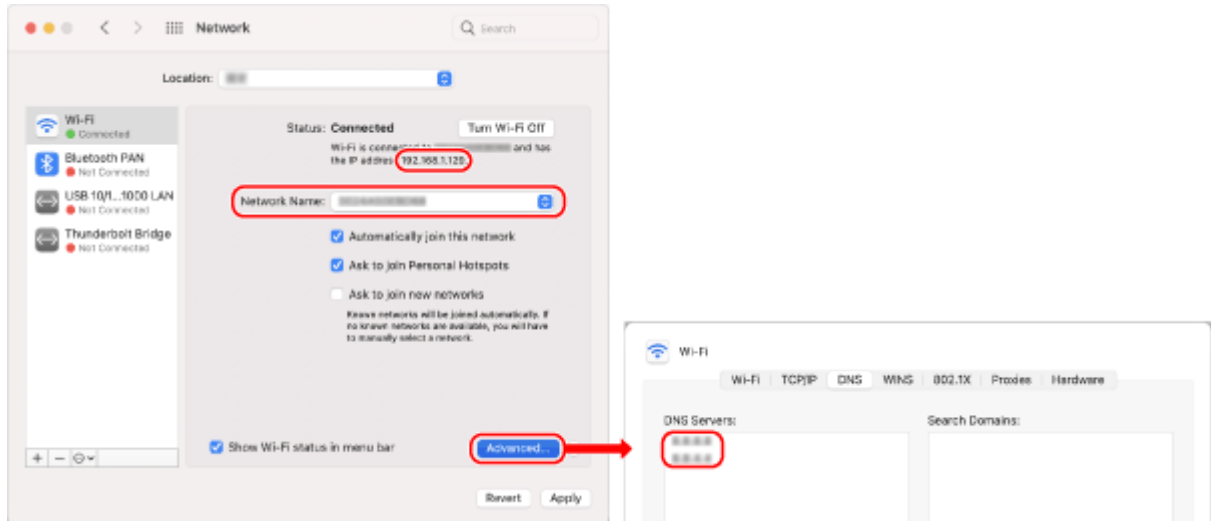

- View the SSID in [Network Name].
- View the IP address in [Status].
- Click [Advanced], and view the DNS server on the [DNS] tab.

## Viewing the Printer Port

### 1 Click [Start] ► [Settings] ► [Devices] ► [Printers & scanners].

► The [Printers & scanners] screen is displayed.

### 2 Click the printer driver of the machine ► [Manage] ► [Printer properties].

► The printer driver properties screen is displayed.

### 3 On the [Ports] tab, view the port being used.

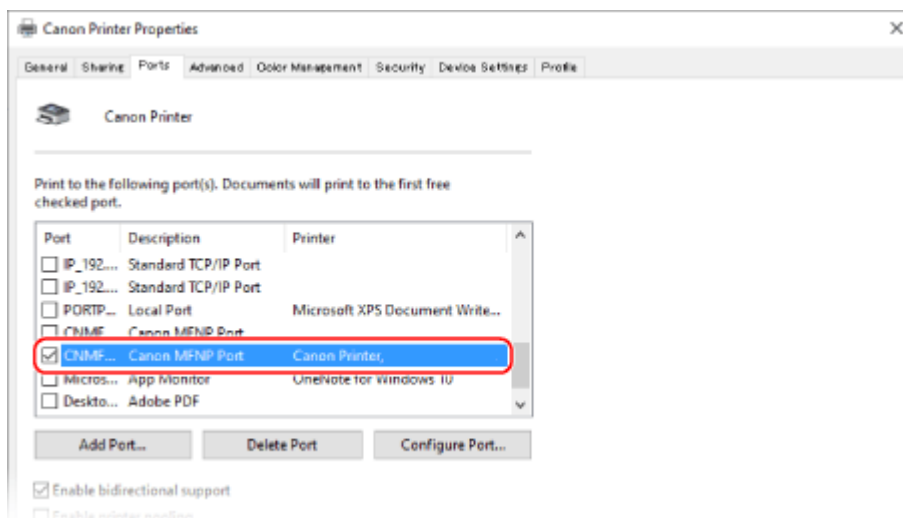

## NOTE

### If the IP Address of the Machine Is Changed

- The required action depends on the port you are using.
  - If [Canon MFNP Port] is displayed in [Description], the connection is maintained as long as the machine and computer belong to the same subnet, so no action is required on the computer.
  - If [Standard TCP/IP Port] is displayed in [Description], you must add a new port. ▶ **Adding a Port(P. 176)**

## Viewing Two-way Communication

### 1 Click [Start] ▶ [Settings] ▶ [Devices] ▶ [Printers & scanners].

⇒ The [Printers & scanners] screen is displayed.

### 2 Click the printer driver of the machine ▶ [Manage] ▶ [Printer properties].

⇒ The printer driver properties screen is displayed.

### 3 On the [Ports] tab, check that the [Enable bidirectional support] checkbox is selected.

## Printing a Test Page

### Required Preparations

- Load A4 size paper in the paper drawer. ▶ **Loading Paper in the Paper Drawer(P. 133)**

▶ **When Using Windows(P. 597)**

▶ **When Using macOS(P. 598)**

### ■ When Using Windows

### 1 Click [Start] ▶ [Settings] ▶ [Devices] ▶ [Printers & scanners].

⇒ The [Printers & scanners] screen is displayed.

### 2 Click the printer driver of the machine ▶ [Manage] ▶ [Printer properties].

⇒ The printer driver properties screen is displayed.

### 3 On the [General] tab, click [Print Test Page].

⇒ When the print data is sent correctly, a test page is printed from the machine.

## ■ When Using macOS

**1** Click [  ] ▶ [System Preferences] ▶ [Printers & Scanners].

▢ The [Printers & Scanners] screen is displayed.

**2** Select the machine, and click [Open Print Queue].

**3** From the [Printer] menu, click [Print Test Page].

▢ When the print data is sent correctly, a test page is printed from the machine.

# Environmental Information, Regulations, and Standards

94WS-0HW

## ■ IPv6 Ready Logo



The protocol stack included in this product has obtained the IPv6 Ready Logo Phase-2 established by the IPv6 Forum.

## ■ Product Information required by COMMISSION REGULATION (EU) No.801/2013 amending Regulation (EC) No.1275/2008

Power consumption of a product in networked standby mode where wired network ports are connected and all wireless network ports are activated (if available at the same time).

Model Name	Power consumption of the product in networked standby mode
MF275dw / MF272dw	3.0 W or less

## NOTE

- The above value(s) are the actual values for a single machine, chosen arbitrarily, and may therefore differ from the value(s) of the actual machine used. Optional network ports are either not connected or not activated in the measurement.

## ■ EU WEEE and Battery Directives



Only for European Union and EEA (Norway, Iceland and Liechtenstein)

These symbols indicate that this product is not to be disposed of with your household waste, according to the WEEE Directive (2012/19/EU), the Battery Directive (2006/66/EC) and/or national legislation implementing those Directives. If a chemical symbol is printed beneath the symbol shown above, in accordance with the Battery Directive, this indicates that a heavy metal (Hg = Mercury, Cd = Cadmium, Pb = Lead) is present in this battery or accumulator at a concentration above an applicable threshold specified in the Battery Directive.

This product should be handed over to a designated collection point, e.g., on an authorized one-for-one basis when you buy a new similar product or to an authorized collection site for recycling waste electrical and electronic equipment (EEE) and batteries and accumulators. Improper handling of this type of waste could have a possible impact on the environment and human health due to potentially hazardous substances that are generally associated with EEE. Your cooperation in the correct disposal of this product will contribute to the effective usage of natural resources.

For more information about the recycling of this product, please contact your local city office, waste authority, approved scheme or your household waste disposal service or visit [www.canon-europe.com/sustainability/approach/](http://www.canon-europe.com/sustainability/approach/).



## ■ Environmental Information

### Reducing your environmental impact while saving money

#### Power Consumption and Activation Time

The amount of electricity a device consumes depends on the way the device is used. This product is designed and set in a way to allow you to reduce your electricity costs. After the last print it switches to Ready Mode. In this mode it can print again immediately if required. If the product is not used for a time, the device switches to its Power Save Mode. The devices consume less power (Watt) in these modes.

If you wish to set a longer Activation Time or would like to completely deactivate the Power Save Mode, please consider that this device may then only switch to a lower energy level after a longer period of time or not at all. Canon does not recommend extending the Activation Times from the optimum ones set as default.

#### Energy Star®

The Energy Star® programme is a voluntary scheme to promote the development and purchase of energy efficient models, which help to minimise environmental impact.

Products which meet the stringent requirements of the Energy Star® programme for both environmental benefits and the amount of energy consumption will carry the Energy Star® logo accordingly.

#### Paper types

This product can be used to print on both recycled and virgin paper (certified to an environmental stewardship scheme), which complies with EN12281 or a similar quality standard. In addition it can support printing on media down to a weight of 64g/m<sup>2</sup>.

Lighter paper means less resources used and a lower environmental footprint for your printing needs.

#### Duplex printing (Standard duplex printing products only)

Duplex printing capability enables you to print on both sides automatically, and therefore helps to reduce the use of valuable resources by reducing your paper consumption.

The duplex function has been auto enabled during the set up and driver installation and Canon strongly recommends that you do not disable this function. You should continue to use the duplex function to reduce the environmental impact of your work with this product at all times.

## ■ When disposing of used toner cartridges

- To protect the environment and make more effective use of resources, Canon promotes the recovery and recycling of used toner cartridges. Please cooperate in the recovery of toner cartridges (resource reuse). For details on resource reuse, see the Canon website:

[global.canon/ctc](http://global.canon/ctc)

When disposing of toner cartridges, pack them in their original packaging to prevent toner dispersal and dispose of the cartridges in accordance with your local government instructions.

## Notice

---

94WS-0HX

- The information in this document is subject to change without notice.
- CANON INC. MAKES NO WARRANTY OF ANY KIND WITH REGARD TO THIS MANUAL, EITHER EXPRESS OR IMPLIED, EXCEPT AS STIPULATED HEREIN, INCLUDING WITHOUT LIMITATION THEREOF WARRANTIES AS TO MARKETABILITY, MERCHANTABILITY, FITNESS FOR A PARTICULAR PURPOSE OF USE, OR NON-INFRINGEMENT OF PATENT RIGHTS. CANON INC. SHALL NOT BE LIABLE FOR ANY DIRECT, INCIDENTAL OR CONSEQUENTIAL DAMAGES OF ANY NATURE, NOR FOR LOSSES OR EXPENSES RESULTING FROM THE USE OF THIS MANUAL.
- If you are unable to view the manual in PDF format, download Adobe Acrobat Reader from the Adobe Systems website (<https://get.adobe.com/reader/>).

# Trademarks and Copyrights

---

94WS-0HY

## ■ Trademarks

Adobe, Acrobat and Reader are registered trademarks of Adobe Systems Incorporated in the United States and/or other countries.

Apple, Bonjour, iPad, iPhone, iPod touch, Mac, macOS, OS X, and Safari are trademarks of Apple Inc. AirPrint and the AirPrint logo are trademarks of Apple Inc.

iOS is a trademark or registered trademark of Cisco in the U.S. and other countries and is used under license.

Mopria®, the Mopria® Logo and the Mopria® Alliance logo are registered trademarks and service marks of Mopria Alliance, Inc. in the United States and other countries. Unauthorized use is strictly prohibited.

Google Chrome, Chrome OS, Chromebook, and Android are trademarks of Google LLC.

This product contains the Universal Font Scaling Technology or UFST® under license from Monotype Imaging, Inc.

UFST® is a trademark of Monotype Imaging, Inc. registered in the United States Patent and Trademark Office and may be registered in certain jurisdictions.

UFST: Copyright © 1989 - 1996, 1997, 2003, 2004, 2008, 2014 all rights reserved, by Monotype Imaging Inc.

All other trademarks are the property of their respective owners.



Copyright © 2008 Adobe Systems Incorporated. All rights reserved.

Protected by U.S. Patents 6,185,684; 6,205,549; 7,213,269; 7,272,628; 7,278,168; Patents pending in the U.S. and other countries.

All instances of the name PostScript in the text are references to the PostScript language as defined by Adobe Systems Incorporated unless otherwise stated. The name PostScript also is used as a product trademark for Adobe Systems' implementation of the PostScript language interpreter.

Except as otherwise stated, any reference to a "PostScript printing device," "PostScript display device," or similar item refers to a printing device, display device or item (respectively) that contains PostScript technology created or licensed by Adobe Systems Incorporated and not to devices or items that purport to be merely compatible with the PostScript language.

Adobe, the Adobe logo, PostScript, the PostScript Logo, and PostScript 3 are either registered trademarks or trademarks of Adobe Systems Incorporated in the United States and/or other countries.

Linux is a registered trademark of Linus Torvalds. Microsoft and Windows are either registered trademarks or trademarks of Microsoft Corporation in the United States and/or other countries.

All other trademarks are the property of their respective owners.

All brand names and product names appearing on this document are registered trademarks or trademarks of their respective owners.

■ Copyright

Unauthorized reproduction of the contents of this document in whole or in part is prohibited.

V\_220726

# Third-party Software

---

94WS-0J0

For details about third-party software, click the following icon:

**Third-Party Services**



**Third-Party Software Included in This Manual**



This Font Software is licensed under the SIL Open Font License, Version 1.1.

This license is copied below, and is also available with a FAQ at: <http://scripts.sil.org/OFL>

-----  
SIL OPEN FONT LICENSE Version 1.1 - 26 February 2007  
-----

#### PREAMBLE

The goals of the Open Font License (OFL) are to stimulate worldwide development of collaborative font projects, to support the font creation efforts of academic and linguistic communities, and to provide a free and open framework in which fonts may be shared and improved in partnership with others.

The OFL allows the licensed fonts to be used, studied, modified and redistributed freely as long as they are not sold by themselves. The fonts, including any derivative works, can be bundled, embedded, redistributed and/or sold with any software provided that any reserved names are not used by derivative works. The fonts and derivatives, however, cannot be released under any other type of license. The requirement for fonts to remain under this license does not apply to any document created using the fonts or their derivatives.

#### DEFINITIONS

"Font Software" refers to the set of files released by the Copyright Holder(s) under this license and clearly marked as such. This may include source files, build scripts and documentation.

"Reserved Font Name" refers to any names specified as such after the copyright statement(s).

"Original Version" refers to the collection of Font Software components as distributed by the Copyright Holder(s).

"Modified Version" refers to any derivative made by adding to, deleting, or substituting -- in part or in whole -- any of the components of the Original Version, by changing formats or by porting the Font Software to a new environment.

"Author" refers to any designer, engineer, programmer, technical writer or other person who contributed to the Font Software.

#### PERMISSION & CONDITIONS

Permission is hereby granted, free of charge, to any person obtaining a copy of the Font Software, to use, study, copy, merge, embed, modify, redistribute, and sell modified and unmodified copies of the Font Software, subject to the following conditions:

- 1) Neither the Font Software nor any of its individual components, in Original or Modified Versions, may be sold by itself.
- 2) Original or Modified Versions of the Font Software may be bundled, redistributed and/or sold with any software, provided that each copy contains the above copyright notice and this license. These can be included either as stand-alone text files, human-readable headers or in the appropriate machine-readable metadata fields within text or binary files as long as those fields can be easily viewed by the user.
- 3) No Modified Version of the Font Software may use the Reserved Font Name(s) unless explicit written permission is granted by the corresponding Copyright Holder. This restriction only applies to the primary font name as presented to the users.
- 4) The name(s) of the Copyright Holder(s) or the Author(s) of the Font Software shall not be used to promote, endorse or advertise any Modified Version, except to acknowledge the contribution(s) of the Copyright Holder(s) and the Author(s) or with their explicit written permission.
- 5) The Font Software, modified or unmodified, in part or in whole, must be distributed entirely under this license, and must not be distributed under any other license. The requirement for fonts to remain under this license does not apply to any document created using the Font Software.

#### TERMINATION

This license becomes null and void if any of the above conditions are not met.

#### DISCLAIMER

THE FONT SOFTWARE IS PROVIDED "AS IS", WITHOUT WARRANTY OF ANY KIND, EXPRESS OR IMPLIED, INCLUDING BUT NOT LIMITED TO ANY WARRANTIES OF MERCHANTABILITY, FITNESS FOR A PARTICULAR PURPOSE AND NONINFRINGEMENT OF COPYRIGHT, PATENT, TRADEMARK, OR OTHER RIGHT. IN NO EVENT SHALL THE COPYRIGHT HOLDER BE LIABLE FOR ANY CLAIM, DAMAGES OR OTHER LIABILITY, INCLUDING ANY GENERAL, SPECIAL, INDIRECT, INCIDENTAL, OR CONSEQUENTIAL DAMAGES, WHETHER IN AN ACTION OF CONTRACT, TORT OR OTHERWISE, ARISING FROM, OUT OF THE USE OR INABILITY TO USE THE FONT SOFTWARE OR FROM OTHER DEALINGS IN THE FONT SOFTWARE.

## The Software Subjected to Other License Conditions

Please refer to Contents of Software and respective License terms below, for more detail and corresponding license conditions.

### Contents of Software

Names of Software	page
1.Adobe PDF Scan Library .....	2
2.Amazon Root CA.....	5
3. expat .....	11
4.Net-SNMP .....	12
5.XKCP.....	24



## 1. Adobe PDF Scan Library

Portions use software under the following terms:

-----  
This product contains either BSAFE and/or TIPEM software by RSA Security Inc.  
-----

This product includes software developed by the Apache Software Foundation (<http://www.apache.org/>).

Copyright (c) 1998–2000 The Apache Software Foundation. All rights reserved.

Redistribution and use in source and binary forms, with or without modification, are permitted provided that the following conditions are met:

1. Redistributions of source code must retain the above copyright notice, this list of conditions and the following disclaimer.
2. Redistributions in binary form must reproduce the above copyright notice, this list of conditions and the following disclaimer in the documentation and/or other materials provided with the distribution.
3. The end–user documentation included with the redistribution, if any, must include the following acknowledgment:

"This product includes software developed by the Apache Software Foundation (<http://www.apache.org/>)."

Alternately, this acknowledgment may appear in the software itself, if and wherever such third–party acknowledgments normally appear.

4. The names "Xerces" and "Apache Software Foundation" must not be used to endorse or promote products derived from this software without prior written permission. For written permission, please contact [apache@apache.org](mailto:apache@apache.org).
5. Products derived from this software may not be called "Apache", nor may "Apache" appear in their name, without prior written permission of the Apache Software Foundation.

THIS SOFTWARE IS PROVIDED ``AS IS" AND ANY EXPRESSED OR IMPLIED WARRANTIES, INCLUDING, BUT NOT LIMITED TO, THE IMPLIED WARRANTIES OF MERCHANTABILITY AND FITNESS FOR A PARTICULAR PURPOSE ARE DISCLAIMED. IN NO EVENT SHALL THE APACHE SOFTWARE FOUNDATION OR ITS CONTRIBUTORS BE LIABLE FOR ANY DIRECT, INDIRECT, INCIDENTAL, SPECIAL, EXEMPLARY, OR CONSEQUENTIAL DAMAGES (INCLUDING, BUT NOT LIMITED TO, PROCUREMENT OF SUBSTITUTE GOODS OR SERVICES; LOSS OF USE, DATA, OR PROFITS; OR BUSINESS INTERRUPTION) HOWEVER CAUSED AND ON ANY THEORY OF LIABILITY, WHETHER IN CONTRACT, STRICT LIABILITY, OR TORT

(INCLUDING NEGLIGENCE OR OTHERWISE) ARISING IN ANY WAY OUT OF THE USE OF THIS SOFTWARE, EVEN IF ADVISED OF THE POSSIBILITY OF SUCH DAMAGE.

This software consists of voluntary contributions made by many individuals on behalf of the Apache Software Foundation and was originally based on software copyright (c) 1999, International Business Machines, Inc., <http://www.ibm.com>. For more information on the Apache Software Foundation, please see <http://www.apache.org/>.

---

March 27, 2003

Portions of this product are based on Modifications created from the Original Code known as the "Sablotron XSLT Processor". The Sablotron XSLT Processor is subject to the Mozilla Public License Version 1.1 (the "License"). You may obtain a copy of the License at <http://www.mozilla.org/MPL/>

Software distributed under the License is distributed on an "AS IS" basis, WITHOUT WARRANTY OF ANY KIND, either express or implied. See the License for the specific language governing rights and limitations under the License.

The Original Code is the Sablotron XSLT Processor.

The Initial Developer of the Original Code is Ginger Alliance Ltd. Portions created by Ginger Alliance are Copyright (C) 2000 Ginger Alliance Ltd. All Rights Reserved.

Pursuant to sections 3.2 and 3.6 of the License, the Modifications created by Adobe Systems Incorporated are available as Source Code. The Modifications may be downloaded via the Internet from:

<http://partners.adobe.com/asn/tech/xml/sablotron/index.jsp>

The Original Code may be downloaded via the Internet from:

<https://sourceforge.net/projects/sablotron/>

---

Portions Copyright (c) 1997–1999 Silicon Graphics Computer Systems, Inc.

Permission to use, copy, modify, distribute and sell this software and its documentation for any purpose is hereby granted without fee, provided that the above copyright notice appear in all copies

and that both that copyright notice and this permission notice appear in supporting documentation. Silicon Graphics makes no representations about the suitability of this software for any purpose. It is provided "as is" without express or implied warranty.

---

The Loki Library

Portions Copyright (c) 2001 by Andrei Alexandrescu . This code accompanies the book: Alexandrescu, Andrei. "Modern C++ Design: Generic Programming and Design Patterns Applied".

Portions Copyright (c) 2001. Addison-Wesley. Permission to use, copy, modify, distribute and sell this software for any purpose is hereby granted without fee, provided that the above copyright notice appear in all copies and that both that copyright notice and this permission notice appear in supporting documentation. The author or Addison-Wesley Longman make no representations about the suitability of this software for any purpose. It is provided "as is" without express or implied warranty.

---

Updated Information/Additional Third Party Code Information available at <http://www.adobe.com/go/thirdparty> .

---

## 2. Amazon Root CA

### Creative Commons Attribution–NoDerivatives 4.0 International Public License

By exercising the Licensed Rights (defined below), You accept and agree to be bound by the terms and conditions of this Creative Commons Attribution–NoDerivatives 4.0 International Public License ("Public License"). To the extent this Public License may be interpreted as a contract, You are granted the Licensed Rights in consideration of Your acceptance of these terms and conditions, and the Licensor grants You such rights in consideration of benefits the Licensor receives from making the Licensed Material available under these terms and conditions.

#### Section 1 – Definitions.

Adapted Material means material subject to Copyright and Similar Rights that is derived from or based upon the Licensed Material and in which the Licensed Material is translated, altered, arranged, transformed, or otherwise modified in a manner requiring permission under the Copyright and Similar Rights held by the Licensor. For purposes of this Public License, where the Licensed Material is a musical work, performance, or sound recording, Adapted Material is always produced where the Licensed Material is synched in timed relation with a moving image.

Copyright and Similar Rights means copyright and/or similar rights closely related to copyright including, without limitation, performance, broadcast, sound recording, and Sui Generis Database Rights, without regard to how the rights are labeled or categorized. For purposes of this Public License, the rights specified in Section 2(b)(1)–(2) are not Copyright and Similar Rights.

Effective Technological Measures means those measures that, in the absence of proper authority, may not be circumvented under laws fulfilling obligations under Article 11 of the WIPO Copyright Treaty adopted on December 20, 1996, and/or similar international agreements.

Exceptions and Limitations means fair use, fair dealing, and/or any other exception or limitation to Copyright and Similar Rights that applies to Your use of the Licensed Material.

Licensed Material means the artistic or literary work, database, or other material to which the Licensor applied this Public License.

Licensed Rights means the rights granted to You subject to the terms and conditions of this Public License, which are limited to all Copyright and Similar Rights that apply to Your use of the Licensed Material and that the Licensor has authority to license.

Licensor means the individual(s) or entity(ies) granting rights under this Public License.

Share means to provide material to the public by any means or process that requires permission under the Licensed Rights, such as reproduction, public display, public performance, distribution, dissemination, communication, or importation, and to make material available to the public including

in ways that members of the public may access the material from a place and at a time individually chosen by them.

Sui Generis Database Rights means rights other than copyright resulting from Directive 96/9/EC of the European Parliament and of the Council of 11 March 1996 on the legal protection of databases, as amended and/or succeeded, as well as other essentially equivalent rights anywhere in the world.

You means the individual or entity exercising the Licensed Rights under this Public License. Your has a corresponding meaning.

Section 2 – Scope.

License grant.

Subject to the terms and conditions of this Public License, the Licensor hereby grants You a worldwide, royalty-free, non-sublicensable, non-exclusive, irrevocable license to exercise the Licensed Rights in the Licensed Material to:

reproduce and Share the Licensed Material, in whole or in part; and

produce and reproduce, but not Share, Adapted Material.

Exceptions and Limitations. For the avoidance of doubt, where Exceptions and Limitations apply to Your use, this Public License does not apply, and You do not need to comply with its terms and conditions.

Term. The term of this Public License is specified in Section 6(a).

Media and formats; technical modifications allowed. The Licensor authorizes You to exercise the Licensed Rights in all media and formats whether now known or hereafter created, and to make technical modifications necessary to do so. The Licensor waives and/or agrees not to assert any right or authority to forbid You from making technical modifications necessary to exercise the Licensed Rights, including technical modifications necessary to circumvent Effective Technological Measures. For purposes of this Public License, simply making modifications authorized by this Section 2(a)(4) never produces Adapted Material.

Downstream recipients.

Offer from the Licensor – Licensed Material. Every recipient of the Licensed Material automatically receives an offer from the Licensor to exercise the Licensed Rights under the terms and conditions of this Public License.

No downstream restrictions. You may not offer or impose any additional or different terms or conditions on, or apply any Effective Technological Measures to, the Licensed Material if doing so restricts exercise of the Licensed Rights by any recipient of the Licensed Material.

No endorsement. Nothing in this Public License constitutes or may be construed as permission to assert or imply that You are, or that Your use of the Licensed Material is, connected with, or sponsored, endorsed, or granted official status by, the Licensor or others designated to receive attribution as provided in Section 3(a)(1)(A)(i).

Other rights.

Moral rights, such as the right of integrity, are not licensed under this Public License, nor are publicity, privacy, and/or other similar personality rights; however, to the extent possible, the Licensor waives and/or agrees not to assert any such rights held by the Licensor to the limited extent necessary to allow You to exercise the Licensed Rights, but not otherwise.

Patent and trademark rights are not licensed under this Public License.

To the extent possible, the Licensor waives any right to collect royalties from You for the exercise of the Licensed Rights, whether directly or through a collecting society under any voluntary or waivable statutory or compulsory licensing scheme. In all other cases the Licensor expressly reserves any right to collect such royalties.

Section 3 – License Conditions.

Your exercise of the Licensed Rights is expressly made subject to the following conditions.

Attribution.

If You Share the Licensed Material, You must:

retain the following if it is supplied by the Licensor with the Licensed Material:

identification of the creator(s) of the Licensed Material and any others designated to receive attribution, in any reasonable manner requested by the Licensor (including by pseudonym if designated);

a copyright notice;

a notice that refers to this Public License;

a notice that refers to the disclaimer of warranties;

a URI or hyperlink to the Licensed Material to the extent reasonably practicable;

indicate if You modified the Licensed Material and retain an indication of any previous modifications;

and

indicate the Licensed Material is licensed under this Public License, and include the text of, or the URI or hyperlink to, this Public License.

For the avoidance of doubt, You do not have permission under this Public License to Share Adapted Material.

You may satisfy the conditions in Section 3(a)(1) in any reasonable manner based on the medium, means, and context in which You Share the Licensed Material. For example, it may be reasonable to satisfy the conditions by providing a URI or hyperlink to a resource that includes the required information.

If requested by the Licensor, You must remove any of the information required by Section 3(a)(1)(A) to the extent reasonably practicable.

#### Section 4 – Sui Generis Database Rights.

Where the Licensed Rights include Sui Generis Database Rights that apply to Your use of the Licensed Material:

for the avoidance of doubt, Section 2(a)(1) grants You the right to extract, reuse, reproduce, and Share all or a substantial portion of the contents of the database, provided You do not Share Adapted Material;

if You include all or a substantial portion of the database contents in a database in which You have Sui Generis Database Rights, then the database in which You have Sui Generis Database Rights (but not its individual contents) is Adapted Material; and

You must comply with the conditions in Section 3(a) if You Share all or a substantial portion of the contents of the database.

For the avoidance of doubt, this Section 4 supplements and does not replace Your obligations under this Public License where the Licensed Rights include other Copyright and Similar Rights.

#### Section 5 – Disclaimer of Warranties and Limitation of Liability.

Unless otherwise separately undertaken by the Licensor, to the extent possible, the Licensor offers the Licensed Material as-is and as-available, and makes no representations or warranties of any kind concerning the Licensed Material, whether express, implied, statutory, or other. This includes, without limitation, warranties of title, merchantability, fitness for a particular purpose, non-infringement, absence of latent or other defects, accuracy, or the presence or absence of errors, whether or not known or discoverable. Where disclaimers of warranties are not allowed in full or in part, this disclaimer may not apply to You.

To the extent possible, in no event will the Licensor be liable to You on any legal theory (including, without limitation, negligence) or otherwise for any direct, special, indirect, incidental, consequential, punitive, exemplary, or other losses, costs, expenses, or damages arising out of this Public License or use of the Licensed Material, even if the Licensor has been advised of the possibility of such losses, costs, expenses, or damages. Where a limitation of liability is not allowed in full or in part, this limitation may not apply to You.

The disclaimer of warranties and limitation of liability provided above shall be interpreted in a manner that, to the extent possible, most closely approximates an absolute disclaimer and waiver of all liability.

#### Section 6 – Term and Termination.

This Public License applies for the term of the Copyright and Similar Rights licensed here. However, if You fail to comply with this Public License, then Your rights under this Public License terminate automatically.

Where Your right to use the Licensed Material has terminated under Section 6(a), it reinstates:

automatically as of the date the violation is cured, provided it is cured within 30 days of Your discovery of the violation; or

upon express reinstatement by the Licensor.

For the avoidance of doubt, this Section 6(b) does not affect any right the Licensor may have to seek remedies for Your violations of this Public License.

For the avoidance of doubt, the Licensor may also offer the Licensed Material under separate terms or conditions or stop distributing the Licensed Material at any time; however, doing so will not terminate this Public License.

Sections 1, 5, 6, 7, and 8 survive termination of this Public License.

Section 7 – Other Terms and Conditions.

The Licensor shall not be bound by any additional or different terms or conditions communicated by You unless expressly agreed.

Any arrangements, understandings, or agreements regarding the Licensed Material not stated herein are separate from and independent of the terms and conditions of this Public License.

Section 8 – Interpretation.

For the avoidance of doubt, this Public License does not, and shall not be interpreted to, reduce, limit, restrict, or impose conditions on any use of the Licensed Material that could lawfully be made without permission under this Public License.

To the extent possible, if any provision of this Public License is deemed unenforceable, it shall be automatically reformed to the minimum extent necessary to make it enforceable. If the provision cannot be reformed, it shall be severed from this Public License without affecting the enforceability of the remaining terms and conditions.

No term or condition of this Public License will be waived and no failure to comply consented to unless expressly agreed to by the Licensor.

Nothing in this Public License constitutes or may be interpreted as a limitation upon, or waiver of, any privileges and immunities that apply to the Licensor or You, including from the legal processes of any jurisdiction or authority.

Creative Commons is not a party to its public licenses. Notwithstanding, Creative Commons may elect to apply one of its public licenses to material it publishes and in those instances will be considered the “Licensor.” The text of the Creative Commons public licenses is dedicated to the public domain under the CC0 Public Domain Dedication. Except for the limited purpose of indicating that material is shared under a Creative Commons public license or as otherwise permitted by the Creative Commons policies published at [creativecommons.org/policies](https://creativecommons.org/policies), Creative Commons does not authorize the use of the trademark “Creative Commons” or any other trademark or logo of Creative



Commons without its prior written consent including, without limitation, in connection with any unauthorized modifications to any of its public licenses or any other arrangements, understandings, or agreements concerning use of licensed material. For the avoidance of doubt, this paragraph does not form part of the public licenses.

Creative Commons may be contacted at [creativecommons.org](https://creativecommons.org).

### 3. expat

Copyright (c) 1998, 1999, 2000 Thai Open Source Software Center Ltd  
and Clark Cooper

Copyright (c) 2001, 2002, 2003, 2004, 2005, 2006 Expat maintainers.

Permission is hereby granted, free of charge, to any person obtaining a copy of this software and associated documentation files (the "Software"), to deal in the Software without restriction, including without limitation the rights to use, copy, modify, merge, publish, distribute, sublicense, and/or sell copies of the Software, and to permit persons to whom the Software is furnished to do so, subject to the following conditions:

The above copyright notice and this permission notice shall be included in all copies or substantial portions of the Software.

THE SOFTWARE IS PROVIDED "AS IS", WITHOUT WARRANTY OF ANY KIND, EXPRESS OR IMPLIED, INCLUDING BUT NOT LIMITED TO THE WARRANTIES OF MERCHANTABILITY, FITNESS FOR A PARTICULAR PURPOSE AND NONINFRINGEMENT. IN NO EVENT SHALL THE AUTHORS OR COPYRIGHT HOLDERS BE LIABLE FOR ANY CLAIM, DAMAGES OR OTHER LIABILITY, WHETHER IN AN ACTION OF CONTRACT, TORT OR OTHERWISE, ARISING FROM, OUT OF OR IN CONNECTION WITH THE SOFTWARE OR THE USE OR OTHER DEALINGS IN THE SOFTWARE.

## 4.Net-SNMP

Various copyrights apply to this package, listed in various separate parts below. Please make sure that you read all the parts.

----- Part 1: CMU/UCD copyright notice: (BSD like) -----

Copyright 1989, 1991, 1992 by Carnegie Mellon University

Derivative Work - 1996, 1998-2000

Copyright 1996, 1998-2000 The Regents of the University of California

All Rights Reserved

Permission to use, copy, modify and distribute this software and its documentation for any purpose and without fee is hereby granted, provided that the above copyright notice appears in all copies and that both that copyright notice and this permission notice appear in supporting documentation, and that the name of CMU and The Regents of the University of California not be used in advertising or publicity pertaining to distribution of the software without specific written permission.

CMU AND THE REGENTS OF THE UNIVERSITY OF CALIFORNIA DISCLAIM ALL WARRANTIES WITH REGARD TO THIS SOFTWARE, INCLUDING ALL IMPLIED WARRANTIES OF MERCHANTABILITY AND FITNESS. IN NO EVENT SHALL CMU OR THE REGENTS OF THE UNIVERSITY OF CALIFORNIA BE LIABLE FOR ANY SPECIAL, INDIRECT OR CONSEQUENTIAL DAMAGES OR ANY DAMAGES WHATSOEVER RESULTING FROM THE LOSS OF USE, DATA OR PROFITS, WHETHER IN AN ACTION OF CONTRACT, NEGLIGENCE OR OTHER TORTIOUS ACTION, ARISING OUT OF OR IN CONNECTION WITH THE USE OR PERFORMANCE OF THIS SOFTWARE.

----- Part 2: Networks Associates Technology, Inc copyright notice (BSD) -----

Copyright (c) 2001-2003, Networks Associates Technology, Inc

All rights reserved.

Redistribution and use in source and binary forms, with or without modification, are permitted provided that the following conditions are met:

- \* Redistributions of source code must retain the above copyright notice, this list of conditions and the following disclaimer.
- \* Redistributions in binary form must reproduce the above copyright notice, this list of conditions and the following disclaimer in the documentation and/or other materials provided with the distribution.
- \* Neither the name of the Networks Associates Technology, Inc nor the names of its contributors may be used to endorse or promote products derived from this software without specific prior written permission.

THIS SOFTWARE IS PROVIDED BY THE COPYRIGHT HOLDERS AND CONTRIBUTORS "AS IS" AND ANY EXPRESS OR IMPLIED WARRANTIES, INCLUDING, BUT NOT LIMITED TO, THE IMPLIED WARRANTIES OF MERCHANTABILITY AND FITNESS FOR A PARTICULAR PURPOSE ARE DISCLAIMED. IN NO EVENT SHALL THE COPYRIGHT HOLDERS OR CONTRIBUTORS BE LIABLE FOR ANY DIRECT, INDIRECT, INCIDENTAL, SPECIAL, EXEMPLARY, OR CONSEQUENTIAL DAMAGES (INCLUDING, BUT NOT LIMITED TO, PROCUREMENT OF SUBSTITUTE GOODS OR SERVICES; LOSS OF USE, DATA, OR PROFITS; OR BUSINESS INTERRUPTION) HOWEVER CAUSED AND ON ANY THEORY OF LIABILITY, WHETHER IN CONTRACT, STRICT LIABILITY, OR TORT (INCLUDING NEGLIGENCE OR OTHERWISE) ARISING IN ANY WAY OUT OF THE USE OF THIS SOFTWARE, EVEN IF ADVISED OF THE POSSIBILITY OF SUCH DAMAGE.

----- Part 3: Cambridge Broadband Ltd. copyright notice (BSD) -----

Portions of this code are copyright (c) 2001-2003, Cambridge Broadband Ltd.  
All rights reserved.

Redistribution and use in source and binary forms, with or without modification, are permitted provided that the following conditions are met:

- \* Redistributions of source code must retain the above copyright notice,

this list of conditions and the following disclaimer.

- \* Redistributions in binary form must reproduce the above copyright notice, this list of conditions and the following disclaimer in the documentation and/or other materials provided with the distribution.
- \* The name of Cambridge Broadband Ltd. may not be used to endorse or promote products derived from this software without specific prior written permission.

THIS SOFTWARE IS PROVIDED BY THE COPYRIGHT HOLDER "AS IS" AND ANY EXPRESS OR IMPLIED WARRANTIES, INCLUDING, BUT NOT LIMITED TO, THE IMPLIED WARRANTIES OF MERCHANTABILITY AND FITNESS FOR A PARTICULAR PURPOSE ARE DISCLAIMED. IN NO EVENT SHALL THE COPYRIGHT HOLDER BE LIABLE FOR ANY DIRECT, INDIRECT, INCIDENTAL, SPECIAL, EXEMPLARY, OR CONSEQUENTIAL DAMAGES (INCLUDING, BUT NOT LIMITED TO, PROCUREMENT OF SUBSTITUTE GOODS OR SERVICES; LOSS OF USE, DATA, OR PROFITS; OR BUSINESS INTERRUPTION) HOWEVER CAUSED AND ON ANY THEORY OF LIABILITY, WHETHER IN CONTRACT, STRICT LIABILITY, OR TORT (INCLUDING NEGLIGENCE OR OTHERWISE) ARISING IN ANY WAY OUT OF THE USE OF THIS SOFTWARE, EVEN IF ADVISED OF THE POSSIBILITY OF SUCH DAMAGE.

----- Part 4: Sun Microsystems, Inc. copyright notice (BSD) -----

Copyright (c) 2003 Sun Microsystems, Inc., 4150 Network Circle, Santa Clara, California 95054, U.S.A. All rights reserved.

Use is subject to license terms below.

This distribution may include materials developed by third parties.

Sun, Sun Microsystems, the Sun logo and Solaris are trademarks or registered trademarks of Sun Microsystems, Inc. in the U.S. and other countries.

Redistribution and use in source and binary forms, with or without modification, are permitted provided that the following conditions are met:

- \* Redistributions of source code must retain the above copyright notice, this list of conditions and the following disclaimer.
- \* Redistributions in binary form must reproduce the above copyright notice, this list of conditions and the following disclaimer in the documentation and/or other materials provided with the distribution.
- \* Neither the name of the Sun Microsystems, Inc. nor the names of its contributors may be used to endorse or promote products derived from this software without specific prior written permission.

THIS SOFTWARE IS PROVIDED BY THE COPYRIGHT HOLDERS AND CONTRIBUTORS "AS IS" AND ANY EXPRESS OR IMPLIED WARRANTIES, INCLUDING, BUT NOT LIMITED TO, THE IMPLIED WARRANTIES OF MERCHANTABILITY AND FITNESS FOR A PARTICULAR PURPOSE ARE DISCLAIMED. IN NO EVENT SHALL THE COPYRIGHT HOLDERS OR CONTRIBUTORS BE LIABLE FOR ANY DIRECT, INDIRECT, INCIDENTAL, SPECIAL, EXEMPLARY, OR CONSEQUENTIAL DAMAGES (INCLUDING, BUT NOT LIMITED TO, PROCUREMENT OF SUBSTITUTE GOODS OR SERVICES; LOSS OF USE, DATA, OR PROFITS; OR BUSINESS INTERRUPTION) HOWEVER CAUSED AND ON ANY THEORY OF LIABILITY, WHETHER IN CONTRACT, STRICT LIABILITY, OR TORT (INCLUDING NEGLIGENCE OR OTHERWISE) ARISING IN ANY WAY OUT OF THE USE OF THIS SOFTWARE, EVEN IF ADVISED OF THE POSSIBILITY OF SUCH DAMAGE.

----- Part 5: Sparta, Inc copyright notice (BSD) -----

Copyright (c) 2003–2013, Sparta, Inc  
All rights reserved.

Redistribution and use in source and binary forms, with or without modification, are permitted provided that the following conditions are met:

- \* Redistributions of source code must retain the above copyright notice, this list of conditions and the following disclaimer.
- \* Redistributions in binary form must reproduce the above copyright notice, this list of conditions and the following disclaimer in the documentation and/or other materials provided with the distribution.

- \* Neither the name of Sparta, Inc nor the names of its contributors may be used to endorse or promote products derived from this software without specific prior written permission.

THIS SOFTWARE IS PROVIDED BY THE COPYRIGHT HOLDERS AND CONTRIBUTORS "AS IS" AND ANY EXPRESS OR IMPLIED WARRANTIES, INCLUDING, BUT NOT LIMITED TO, THE IMPLIED WARRANTIES OF MERCHANTABILITY AND FITNESS FOR A PARTICULAR PURPOSE ARE DISCLAIMED. IN NO EVENT SHALL THE COPYRIGHT HOLDERS OR CONTRIBUTORS BE LIABLE FOR ANY DIRECT, INDIRECT, INCIDENTAL, SPECIAL, EXEMPLARY, OR CONSEQUENTIAL DAMAGES (INCLUDING, BUT NOT LIMITED TO, PROCUREMENT OF SUBSTITUTE GOODS OR SERVICES; LOSS OF USE, DATA, OR PROFITS; OR BUSINESS INTERRUPTION) HOWEVER CAUSED AND ON ANY THEORY OF LIABILITY, WHETHER IN CONTRACT, STRICT LIABILITY, OR TORT (INCLUDING NEGLIGENCE OR OTHERWISE) ARISING IN ANY WAY OUT OF THE USE OF THIS SOFTWARE, EVEN IF ADVISED OF THE POSSIBILITY OF SUCH DAMAGE.

----- Part 6: Cisco/BUPTNIC copyright notice (BSD) -----

Copyright (c) 2004, Cisco, Inc and Information Network  
Center of Beijing University of Posts and Telecommunications.  
All rights reserved.

Redistribution and use in source and binary forms, with or without modification, are permitted provided that the following conditions are met:

- \* Redistributions of source code must retain the above copyright notice, this list of conditions and the following disclaimer.
- \* Redistributions in binary form must reproduce the above copyright notice, this list of conditions and the following disclaimer in the documentation and/or other materials provided with the distribution.
- \* Neither the name of Cisco, Inc, Beijing University of Posts and Telecommunications, nor the names of their contributors may be used to endorse or promote products derived from this software without specific prior written permission.

THIS SOFTWARE IS PROVIDED BY THE COPYRIGHT HOLDERS AND CONTRIBUTORS ``AS IS" AND ANY EXPRESS OR IMPLIED WARRANTIES, INCLUDING, BUT NOT LIMITED TO, THE IMPLIED WARRANTIES OF MERCHANTABILITY AND FITNESS FOR A PARTICULAR PURPOSE ARE DISCLAIMED. IN NO EVENT SHALL THE COPYRIGHT HOLDERS OR CONTRIBUTORS BE LIABLE FOR ANY DIRECT, INDIRECT, INCIDENTAL, SPECIAL, EXEMPLARY, OR CONSEQUENTIAL DAMAGES (INCLUDING, BUT NOT LIMITED TO, PROCUREMENT OF SUBSTITUTE GOODS OR SERVICES; LOSS OF USE, DATA, OR PROFITS; OR BUSINESS INTERRUPTION) HOWEVER CAUSED AND ON ANY THEORY OF LIABILITY, WHETHER IN CONTRACT, STRICT LIABILITY, OR TORT (INCLUDING NEGLIGENCE OR OTHERWISE) ARISING IN ANY WAY OUT OF THE USE OF THIS SOFTWARE, EVEN IF ADVISED OF THE POSSIBILITY OF SUCH DAMAGE.

----- Part 7: Fabasoft R&D Software GmbH & Co KG copyright notice (BSD) -----

Copyright (c) Fabasoft R&D Software GmbH & Co KG, 2003

oss@fabasoft.com

Author: Bernhard Penz <bernhard.penz@fabasoft.com>

Redistribution and use in source and binary forms, with or without modification, are permitted provided that the following conditions are met:

- \* Redistributions of source code must retain the above copyright notice, this list of conditions and the following disclaimer.
- \* Redistributions in binary form must reproduce the above copyright notice, this list of conditions and the following disclaimer in the documentation and/or other materials provided with the distribution.
- \* The name of Fabasoft R&D Software GmbH & Co KG or any of its subsidiaries, brand or product names may not be used to endorse or promote products derived from this software without specific prior written permission.

THIS SOFTWARE IS PROVIDED BY THE COPYRIGHT HOLDER ``AS IS" AND ANY EXPRESS OR IMPLIED WARRANTIES, INCLUDING, BUT NOT LIMITED TO, THE IMPLIED WARRANTIES OF MERCHANTABILITY AND FITNESS FOR A PARTICULAR PURPOSE ARE DISCLAIMED. IN NO EVENT SHALL THE COPYRIGHT HOLDER BE LIABLE FOR ANY DIRECT, INDIRECT, INCIDENTAL, SPECIAL, EXEMPLARY, OR CONSEQUENTIAL DAMAGES (INCLUDING, BUT NOT LIMITED TO, PROCUREMENT OF



SUBSTITUTE GOODS OR SERVICES; LOSS OF USE, DATA, OR PROFITS; OR BUSINESS INTERRUPTION) HOWEVER CAUSED AND ON ANY THEORY OF LIABILITY, WHETHER IN CONTRACT, STRICT LIABILITY, OR TORT (INCLUDING NEGLIGENCE OR OTHERWISE) ARISING IN ANY WAY OUT OF THE USE OF THIS SOFTWARE, EVEN IF ADVISED OF THE POSSIBILITY OF SUCH DAMAGE.

----- Part 8: Apple Inc. copyright notice (BSD) -----

Copyright (c) 2007 Apple Inc. All rights reserved.

Redistribution and use in source and binary forms, with or without modification, are permitted provided that the following conditions are met:

1. Redistributions of source code must retain the above copyright notice, this list of conditions and the following disclaimer.
2. Redistributions in binary form must reproduce the above copyright notice, this list of conditions and the following disclaimer in the documentation and/or other materials provided with the distribution.
3. Neither the name of Apple Inc. ("Apple") nor the names of its contributors may be used to endorse or promote products derived from this software without specific prior written permission.

THIS SOFTWARE IS PROVIDED BY APPLE AND ITS CONTRIBUTORS "AS IS" AND ANY EXPRESS OR IMPLIED WARRANTIES, INCLUDING, BUT NOT LIMITED TO, THE IMPLIED WARRANTIES OF MERCHANTABILITY AND FITNESS FOR A PARTICULAR PURPOSE ARE DISCLAIMED. IN NO EVENT SHALL APPLE OR ITS CONTRIBUTORS BE LIABLE FOR ANY DIRECT, INDIRECT, INCIDENTAL, SPECIAL, EXEMPLARY, OR CONSEQUENTIAL DAMAGES (INCLUDING, BUT NOT LIMITED TO, PROCUREMENT OF SUBSTITUTE GOODS OR SERVICES; LOSS OF USE, DATA, OR PROFITS; OR BUSINESS INTERRUPTION) HOWEVER CAUSED AND ON ANY THEORY OF LIABILITY, WHETHER IN CONTRACT, STRICT LIABILITY, OR TORT (INCLUDING NEGLIGENCE OR OTHERWISE) ARISING IN ANY WAY OUT OF THE USE OF THIS SOFTWARE, EVEN IF ADVISED OF THE POSSIBILITY OF SUCH DAMAGE.

----- Part 9: ScienceLogic, LLC copyright notice (BSD) -----

Copyright (c) 2009, ScienceLogic, LLC  
All rights reserved.

Redistribution and use in source and binary forms, with or without modification, are permitted provided that the following conditions are met:

- \* Redistributions of source code must retain the above copyright notice, this list of conditions and the following disclaimer.
- \* Redistributions in binary form must reproduce the above copyright notice, this list of conditions and the following disclaimer in the documentation and/or other materials provided with the distribution.
- \* Neither the name of ScienceLogic, LLC nor the names of its contributors may be used to endorse or promote products derived from this software without specific prior written permission.

THIS SOFTWARE IS PROVIDED BY THE COPYRIGHT HOLDERS AND CONTRIBUTORS  
`AS IS" AND ANY EXPRESS OR IMPLIED WARRANTIES, INCLUDING, BUT NOT  
LIMITED TO, THE IMPLIED WARRANTIES OF MERCHANTABILITY AND FITNESS FOR  
A PARTICULAR PURPOSE ARE DISCLAIMED. IN NO EVENT SHALL THE COPYRIGHT  
HOLDERS OR CONTRIBUTORS BE LIABLE FOR ANY DIRECT, INDIRECT,  
INCIDENTAL, SPECIAL, EXEMPLARY, OR CONSEQUENTIAL DAMAGES (INCLUDING,  
BUT NOT LIMITED TO, PROCUREMENT OF SUBSTITUTE GOODS OR SERVICES; LOSS  
OF USE, DATA, OR PROFITS; OR BUSINESS INTERRUPTION) HOWEVER CAUSED AND  
ON ANY THEORY OF LIABILITY, WHETHER IN CONTRACT, STRICT LIABILITY, OR  
TORT (INCLUDING NEGLIGENCE OR OTHERWISE) ARISING IN ANY WAY OUT OF THE  
USE OF THIS SOFTWARE, EVEN IF ADVISED OF THE POSSIBILITY OF SUCH  
DAMAGE.

----- Part 10: Lennart Poettering copyright notice (BSD-like) -----

Copyright 2010 Lennart Poettering

Permission is hereby granted, free of charge, to any person  
obtaining a copy of this software and associated documentation files

(the "Software"), to deal in the Software without restriction, including without limitation the rights to use, copy, modify, merge, publish, distribute, sublicense, and/or sell copies of the Software, and to permit persons to whom the Software is furnished to do so, subject to the following conditions:

The above copyright notice and this permission notice shall be included in all copies or substantial portions of the Software.

THE SOFTWARE IS PROVIDED "AS IS", WITHOUT WARRANTY OF ANY KIND, EXPRESS OR IMPLIED, INCLUDING BUT NOT LIMITED TO THE WARRANTIES OF MERCHANTABILITY, FITNESS FOR A PARTICULAR PURPOSE AND NONINFRINGEMENT. IN NO EVENT SHALL THE AUTHORS OR COPYRIGHT HOLDERS BE LIABLE FOR ANY CLAIM, DAMAGES OR OTHER LIABILITY, WHETHER IN AN ACTION OF CONTRACT, TORT OR OTHERWISE, ARISING FROM, OUT OF OR IN CONNECTION WITH THE SOFTWARE OR THE USE OR OTHER DEALINGS IN THE SOFTWARE.

----- Part 11: IETF copyright notice (BSD) -----

Copyright (c) 2013 IETF Trust and the persons identified as authors of the code. All rights reserved.

Redistribution and use in source and binary forms, with or without modification, are permitted provided that the following conditions are met:

- \* Redistributions of source code must retain the above copyright notice, this list of conditions and the following disclaimer.
- \* Redistributions in binary form must reproduce the above copyright notice, this list of conditions and the following disclaimer in the documentation and/or other materials provided with the distribution.
- \* Neither the name of Internet Society, IETF or IETF Trust, nor the names of specific contributors, may be used to endorse or promote products derived from this software without specific prior written permission.

THIS SOFTWARE IS PROVIDED BY THE COPYRIGHT HOLDERS AND CONTRIBUTORS ``AS IS" AND ANY EXPRESS OR IMPLIED WARRANTIES, INCLUDING, BUT NOT LIMITED TO, THE IMPLIED WARRANTIES OF MERCHANTABILITY AND FITNESS FOR A PARTICULAR PURPOSE ARE DISCLAIMED. IN NO EVENT SHALL THE COPYRIGHT OWNER OR CONTRIBUTORS BE LIABLE FOR ANY DIRECT, INDIRECT, INCIDENTAL, SPECIAL, EXEMPLARY, OR CONSEQUENTIAL DAMAGES (INCLUDING, BUT NOT LIMITED TO, PROCUREMENT OF SUBSTITUTE GOODS OR SERVICES; LOSS OF USE, DATA, OR PROFITS; OR BUSINESS INTERRUPTION) HOWEVER CAUSED AND ON ANY THEORY OF LIABILITY, WHETHER IN CONTRACT, STRICT LIABILITY, OR TORT (INCLUDING NEGLIGENCE OR OTHERWISE) ARISING IN ANY WAY OUT OF THE USE OF THIS SOFTWARE, EVEN IF ADVISED OF THE POSSIBILITY OF SUCH DAMAGE.

----- Part 12: Arista Networks copyright notice (BSD) -----

Copyright (c) 2013, Arista Networks, Inc.  
All rights reserved.

Redistribution and use in source and binary forms, with or without modification, are permitted provided that the following conditions are met:

- \* Redistributions of source code must retain the above copyright notice, this list of conditions and the following disclaimer.
- \* Redistributions in binary form must reproduce the above copyright notice, this list of conditions and the following disclaimer in the documentation and/or other materials provided with the distribution.
- \* Neither the name of Arista Networks, Inc. nor the names of its contributors may be used to endorse or promote products derived from this software without specific prior written permission.

THIS SOFTWARE IS PROVIDED BY THE COPYRIGHT HOLDERS AND CONTRIBUTORS ``AS IS" AND ANY EXPRESS OR IMPLIED WARRANTIES, INCLUDING, BUT NOT LIMITED TO, THE IMPLIED WARRANTIES OF MERCHANTABILITY AND FITNESS FOR A PARTICULAR PURPOSE ARE DISCLAIMED. IN NO EVENT SHALL THE COPYRIGHT HOLDERS OR CONTRIBUTORS BE LIABLE FOR ANY DIRECT, INDIRECT,

INCIDENTAL, SPECIAL, EXEMPLARY, OR CONSEQUENTIAL DAMAGES (INCLUDING, BUT NOT LIMITED TO, PROCUREMENT OF SUBSTITUTE GOODS OR SERVICES; LOSS OF USE, DATA, OR PROFITS; OR BUSINESS INTERRUPTION) HOWEVER CAUSED AND ON ANY THEORY OF LIABILITY, WHETHER IN CONTRACT, STRICT LIABILITY, OR TORT (INCLUDING NEGLIGENCE OR OTHERWISE) ARISING IN ANY WAY OUT OF THE USE OF THIS SOFTWARE, EVEN IF ADVISED OF THE POSSIBILITY OF SUCH DAMAGE.

----- Part 13: VMware, Inc. copyright notice (BSD) -----

Copyright (c) 2016, VMware, Inc.  
All rights reserved.

Redistribution and use in source and binary forms, with or without modification, are permitted provided that the following conditions are met:

- \* Redistributions of source code must retain the above copyright notice, this list of conditions and the following disclaimer.
- \* Redistributions in binary form must reproduce the above copyright notice, this list of conditions and the following disclaimer in the documentation and/or other materials provided with the distribution.
- \* Neither the name of VMware, Inc. nor the names of its contributors may be used to endorse or promote products derived from this software without specific prior written permission.

THIS SOFTWARE IS PROVIDED BY THE COPYRIGHT HOLDERS AND CONTRIBUTORS "AS IS" AND ANY EXPRESS OR IMPLIED WARRANTIES, INCLUDING, BUT NOT LIMITED TO, THE IMPLIED WARRANTIES OF MERCHANTABILITY AND FITNESS FOR A PARTICULAR PURPOSE ARE DISCLAIMED. IN NO EVENT SHALL THE COPYRIGHT HOLDERS OR CONTRIBUTORS BE LIABLE FOR ANY DIRECT, INDIRECT, INCIDENTAL, SPECIAL, EXEMPLARY, OR CONSEQUENTIAL DAMAGES (INCLUDING, BUT NOT LIMITED TO, PROCUREMENT OF SUBSTITUTE GOODS OR SERVICES; LOSS OF USE, DATA, OR PROFITS; OR BUSINESS INTERRUPTION) HOWEVER CAUSED AND ON ANY THEORY OF LIABILITY, WHETHER IN CONTRACT, STRICT LIABILITY, OR TORT (INCLUDING NEGLIGENCE OR OTHERWISE) ARISING IN ANY WAY OUT OF THE USE OF THIS SOFTWARE, EVEN IF ADVISED OF THE POSSIBILITY OF SUCH DAMAGE.

----- Part 14: USC/Information Sciences Institute copyright notice (BSD) -----

Copyright (c) 2017–2018, Information Sciences Institute  
All rights reserved.

Redistribution and use in source and binary forms, with or without  
modification, are permitted provided that the following conditions are met:

- \* Redistributions of source code must retain the above copyright notice,  
this list of conditions and the following disclaimer.
- \* Redistributions in binary form must reproduce the above copyright  
notice, this list of conditions and the following disclaimer in the  
documentation and/or other materials provided with the distribution.
- \* Neither the name of Information Sciences Institute nor the names of its  
contributors may be used to endorse or promote products derived from  
this software without specific prior written permission.

THIS SOFTWARE IS PROVIDED BY THE COPYRIGHT HOLDERS AND CONTRIBUTORS "AS IS" AND ANY EXPRESS OR IMPLIED WARRANTIES, INCLUDING, BUT NOT LIMITED TO, THE IMPLIED WARRANTIES OF MERCHANTABILITY AND FITNESS FOR A PARTICULAR PURPOSE ARE DISCLAIMED. IN NO EVENT SHALL THE COPYRIGHT HOLDERS OR CONTRIBUTORS BE LIABLE FOR ANY DIRECT, INDIRECT, INCIDENTAL, SPECIAL, EXEMPLARY, OR CONSEQUENTIAL DAMAGES (INCLUDING, BUT NOT LIMITED TO, PROCUREMENT OF SUBSTITUTE GOODS OR SERVICES; LOSS OF USE, DATA, OR PROFITS; OR BUSINESS INTERRUPTION) HOWEVER CAUSED AND ON ANY THEORY OF LIABILITY, WHETHER IN CONTRACT, STRICT LIABILITY, OR TORT (INCLUDING NEGLIGENCE OR OTHERWISE) ARISING IN ANY WAY OUT OF THE USE OF THIS SOFTWARE, EVEN IF ADVISED OF THE POSSIBILITY OF SUCH DAMAGE.

## 5.XKCP

# Implementation by the Keccak Team, namely, Guido Bertoni, Joan Daemen,  
#Michael Peeters, Gilles Van Assche and Ronny Van Keer,  
#hereby denoted as "the implementer".

# To the extent possible under law, the implementer has waived all copyright  
# and related or neighboring rights to the source code in this file.

# <http://creativecommons.org/publicdomain/zero/1.0/>