

**TCL** K70 Power 4G

## Note:

This is a user manual for TCL T522E/T522E1.

This document is for reference only. The actual product (including but not limited to color, size, screen layout, etc.) may differ from the description depending on the region, service provider, or software version. This document is subject to changes without prior notice. Please refer to the actual product for accurate details. All statements, information and recommendations in this document do not constitute any form of warranty, whether express or implied.

## Help

Refer to the following resources to get more FAQ, software, and service information:

### Consulting FAQ

Go to [www.tcl.com/global/en/service-support-mobile/faq.html](http://www.tcl.com/global/en/service-support-mobile/faq.html)

### Finding your serial number or IMEI

You can find your serial number or International Mobile Equipment Identity (IMEI) on the packaging materials. Alternatively, choose **Settings > My device > Status > IMEI** on the phone itself.

### Obtaining warranty service

First follow the advice in this guide or go to <https://www.tcl.com/global/en/mobile-support.html>. Then check hotlines and repair centre information.

For more information about limited warranty, please go to <https://www.tcl.com/global/en/warranty>

### Viewing legal information

On the phone, go to **Settings > My device > Legal information**.

### Cybersecurity requirements

To comply with the cybersecurity requirements of the Radio Equipment Directive 2014/53/EU, please set a strong password upon the device's first use.

### Viewing information about energy labelling

For detailed information about energy label, please go to <https://eprel.ec.europa.eu/screen/product/smartphonetablets20231669/2408150>

# Table of Contents

<b>1</b>	<b>Basics.....</b>	<b>4</b>
1.1	Device overview.....	4
1.2	Accessibility.....	6
1.3	Getting started .....	7
1.4	Home screen.....	10
1.5	Text input.....	18
<b>2</b>	<b>Multimedia applications .....</b>	<b>20</b>
2.1	Camera .....	20
2.2	Photos.....	24
<b>3</b>	<b>Apps and features .....</b>	<b>26</b>
3.1	Phone.....	26
3.2	Contacts .....	31
3.3	Messages .....	34
3.4	Switch Phone.....	37
3.5	Clock.....	38
3.6	TCL apps .....	39
3.7	Other applications .....	39
3.8	Google applications.....	39
<b>4</b>	<b>Settings .....</b>	<b>42</b>
4.1	My device .....	42
4.2	Wi-Fi.....	42
4.3	Bluetooth.....	43
4.4	Network & internet.....	44
4.5	Connections .....	44

4.6	Wallpaper & style.....	47
4.7	Home screen & lock screen.....	47
4.8	Display.....	47
4.9	Sound & vibration.....	50
4.10	Notifications.....	51
4.11	Battery.....	51
4.12	Smart Manager.....	51
4.13	Storage.....	51
4.14	Apps.....	51
4.15	Advanced features.....	52
4.16	Security & privacy.....	53
4.17	Location.....	54
4.18	Safety & emergency.....	54
4.19	Accounts.....	55
4.20	Digital Wellbeing and parental controls.....	55
4.21	Google.....	55
4.22	Accessibility.....	55
4.23	System.....	58
<b>5</b>	<b>Making the most of your phone.....</b>	<b>60</b>
<b>6</b>	<b>Troubleshooting.....</b>	<b>61</b>
<b>7</b>	<b>Specifications.....</b>	<b>67</b>
<b>8</b>	<b>ECO design technical information.....</b>	<b>69</b>
<b>9</b>	<b>Accessories.....</b>	<b>70</b>
<b>10</b>	<b>Licences.....</b>	<b>70</b>
<b>11</b>	<b>Disclaimer.....</b>	<b>70</b>

# 1 Basics

## 1.1 Device overview



- 1 Front camera
- 2 Touch screen
- 3 Microphone
- 4 Headset connector
- 5 Type-C USB

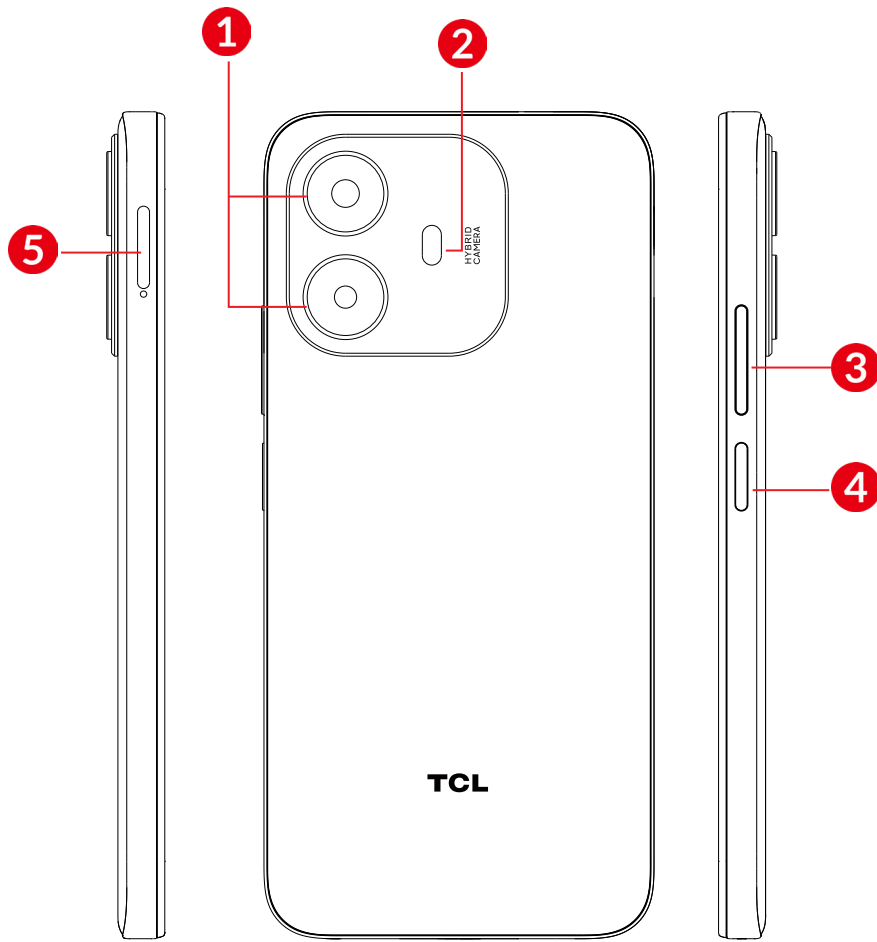

- 1** Camera
- 2** Back flash
- 3** Volume up/down keys
- 4** Power key/Fingerprint key
- 5** SIM card slot

## Power key/Fingerprint key

- Press: Lock the screen/Light up the screen.
- Long press the **Power key**: Sign in to use Gemini
- Press and hold the **Power key** and **Volume down** key to take a screenshot.
- Double-press the Power key to open the camera.

## Volume Keys

- In call mode, adjusts the earpiece or headset volume.
- In Music/Video/Streaming mode, adjusts the media volume.
- In general mode, adjusts the media volume.
- Mutes the ringtone of an incoming call.
- In camera preview mode, press the **Volume up** or **down** key to take a photo or press and hold to take burst shots.

## 1.2 Accessibility<sup>(1)</sup>

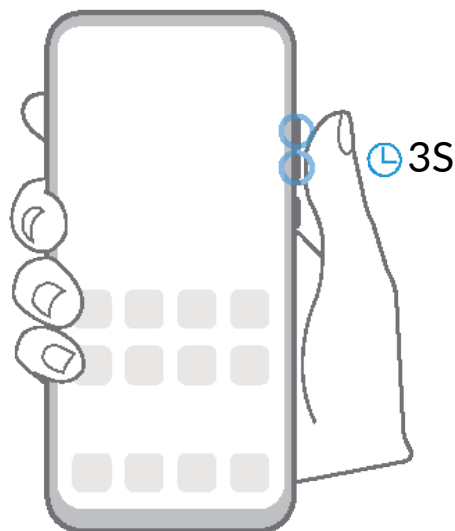

To turn on hearing assistance, press the **Volume up** and **Volume down** keys simultaneously for 3 seconds or go to **Settings > Accessibility > TalkBack**.

To activate more accessibility features, go to **Settings > Accessibility**.

Hearing assistance is based on TalkBack technology, a gesture-based screen reader that lets you use the device without looking at the screen. TalkBack provides an spoken audio of the screen content from battery level and caller information to the app your finger is on.

<sup>(1)</sup> Application availability may vary depending on the country and operator.

# 1.3 Getting started

## Setting up

### Inserting or removing the SIM card

- ① Insert the provided SIM pin into the hole.
- ② Pull out the SIM tray.
- ③ Place the SIM card into the tray slot and carefully close the SIM tray.

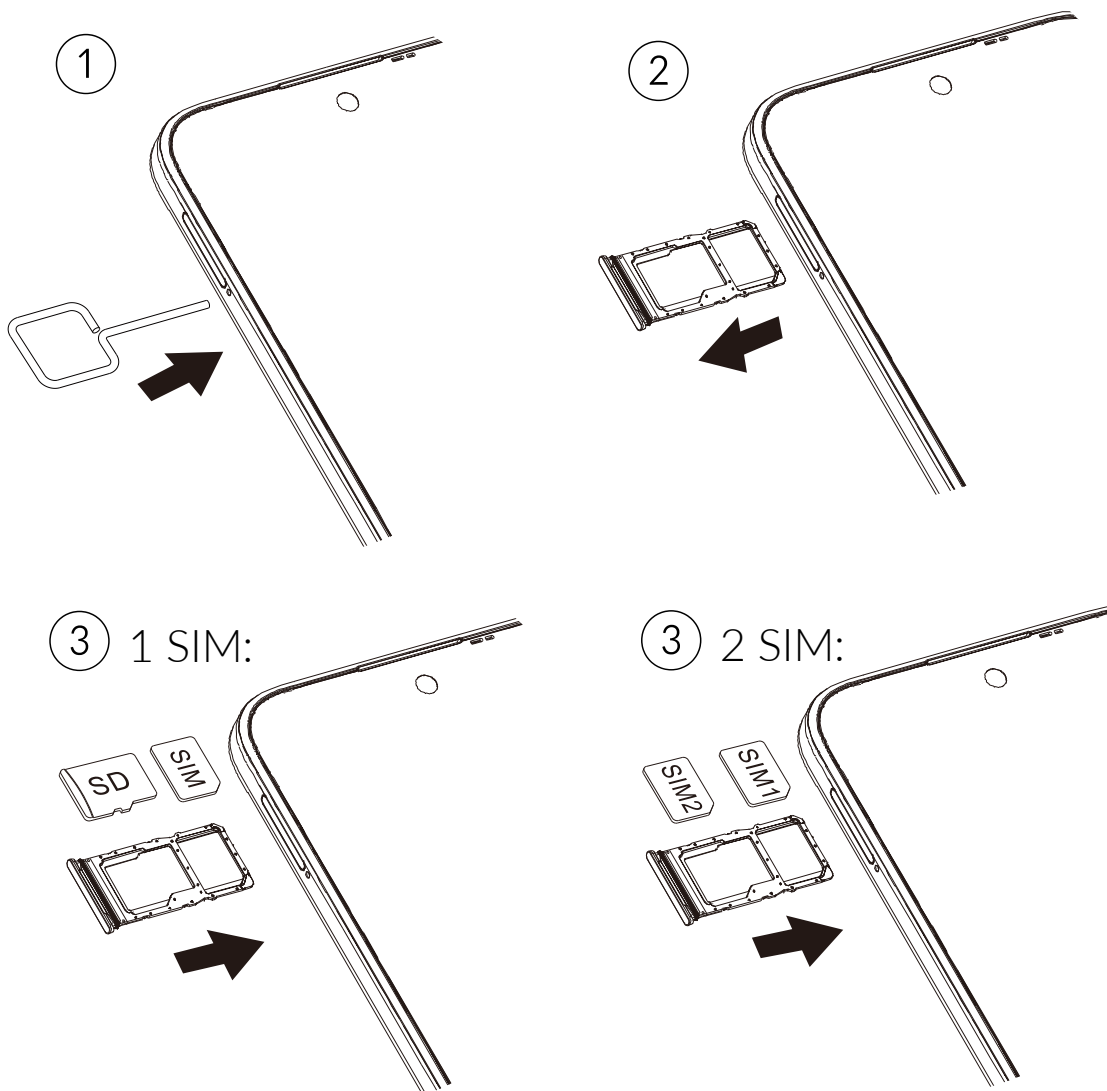



You must insert your SIM card to make phone calls. You do not need to power off your phone before inserting or removing the SIM card as this phone supports hot swap.

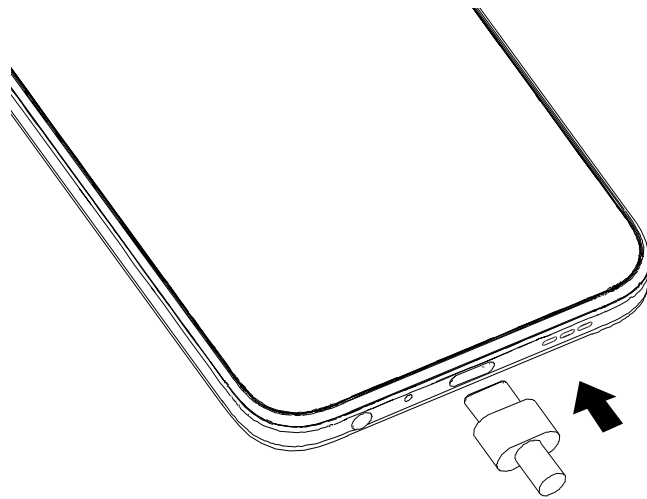

Your phone only supports nano-SIM cards. Do not attempt to insert other SIM types; otherwise this may cause damage to your phone.

## Charging the battery



You are advised to fully charge the battery (  ). Charging status is indicated by a percentage displayed on screen while the phone is powered off. The percentage increases as the phone is charged.

Learn more about battery life and proper use to maximize your battery's performance.

- Don't use or place your device in extreme temperatures. Extreme temperatures, whether too high or too low, can accelerate battery degradation and reduce its overall lifespan. For optimal performance, the manufacturer's recommended operating temperature range is 0°C (32°F) to 40°C (104°F).
- Deactivate Wi-Fi, GPS, Bluetooth when not in use.
- Deactivate auto-syncing of apps, close unnecessary apps.
- Turn display off by pressing the power key when the device is not in use.
- Set Screen timeout to a short interval.
- Lower the screen brightness.
- After charging 100%, disconnect charger from the plug. Do not keep device constantly under charge, this will reduce the battery life.
- Think of activating your phone's **Intelligent charging mode** (**Settings > Smart Manager > Battery > Battery health > Intelligent charging mode**) to stop charging at 80% battery level, for a longer battery life.
- To minimize the effect, it is recommended to use fast charging only when necessary and avoid keeping the battery at high charge levels for extended periods

Battery capacity and usage hours may vary depending on device settings and usage patterns.

**Note:** For environmental reasons this package may not include a charger, depending on the device you purchased. This device can be powered with most USB power adapters and a cable with USB Type-C plug.

To correctly charge your device you can use any charger as long as it meets all applicable standards for safety of information technology equipment and office equipment with minimum requirements as above listed.

Please do not use chargers which are not safe or do not meet the above specifications.

## **Powering on your phone**

Hold down the **Power** key until the phone powers on, unlock your phone (Swipe, PIN, Password, Pattern, Fingerprint or Face) if necessary and confirm. The Home screen is displayed.

If you do not know your PIN code or forget it, contact your network operator. Be sure to keep your PIN code secure.

## **Powering off your phone**

Press the **Power** key and **Volume up** key until options appear, then select **Power off**.

## 1.4 Home screen

You can bring all the items (applications, shortcuts, folders and widgets) you love or use most frequently to your Home screen for quick access. To return to the Home screen, swipe up from the bar at the bottom edge of the screen.



### 1 Status bar

- Status/Notification indicators
- Swipe down from the left side of the status bar to open the notification panel

### 2 Search bar

- Touch 1 to enter text search screen
- Touch 2 to enter voice search screen

### 3 Touch an icon to open an application, folder, etc.

### 4 Favourite tray applications

- Touch to enter the application.
- Touch and hold to move or remove applications.

## Using the touchscreen

**Touch** 

To access an application, touch it with your finger.

**Touch and hold** 

To enter the available options for an item, touch and hold the item. For example. Select a contact in Contacts and touch and hold it. An options list will then appear.

**Drag** 

Place your finger on the screen to drag an object to another location.

**Slide/Swipe** 

Slide the screen to scroll up and down the applications, images, and web pages. You can slide the screen horizontally too.

**Flick** 

Similar to swiping, but flicking makes it move quicker.

**Rotate** 

Automatically change the screen orientation from portrait to landscape by turning the phone sideways to have a better screen view.

## Status bar

From the status bar, you can view both phone status and notification information.

### Notification panel

When there are notifications, swipe down from the left side of the status bar to open the Notification panel to read more detailed information.

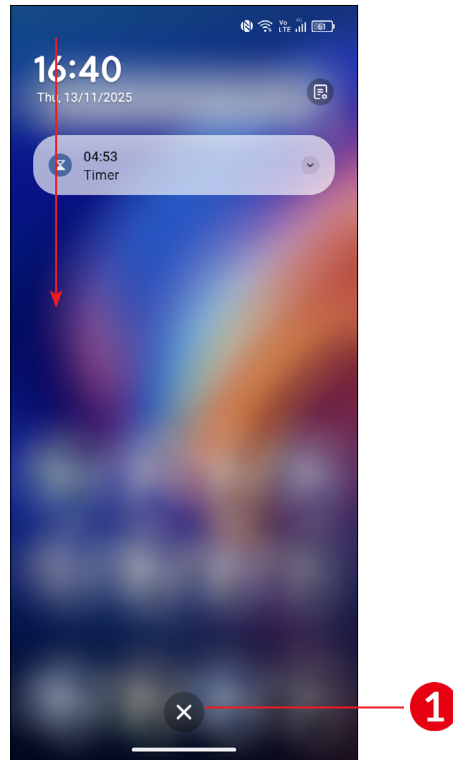

- 1** Touch to clear all event-based notifications (other ongoing notifications will remain).

## Quick settings panel

Swipe down from the right side of the status bar to open the Quick settings panel.

You can enable or disable functions or change modes by touching the icons.

Touch the **Edit** icon  to customise your Quick settings panel.

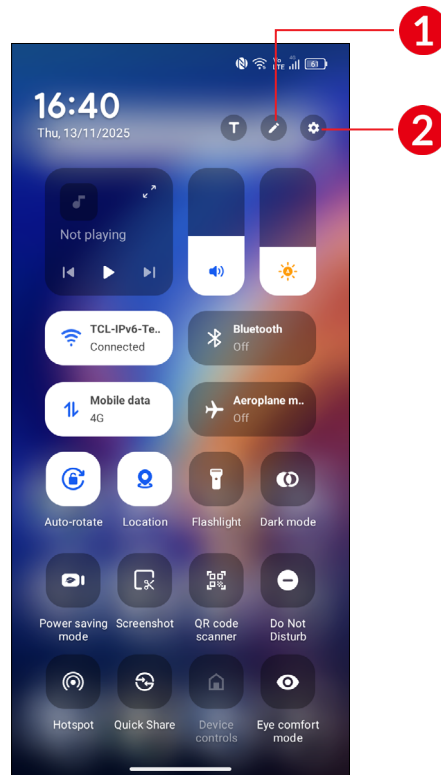

**1** Touch to customise your Quick settings panel.

**2** Touch to access **Settings**, where you can set more items.

## Lock/Unlock your screen

To protect your phone and privacy, you can lock the screen with a pattern, PIN, password, fingerprint or face.

To create a screen unlock pattern, touch **Settings > Security & privacy > Device unlock > Face & Fingerprint unlock**.

### To lock the phone screen

- If your phone remains inactive for a period of time, it will automatically lock the screen and enter sleep mode to save power. Go to **Settings > Display > Sleep** and select a screen timeout period.
- You can also manually lock the screen by pressing the **Power** key once.

## To unlock the phone screen

Press the **Power** key once to light up the screen, swipe up and unlock the screen with the method you have set.

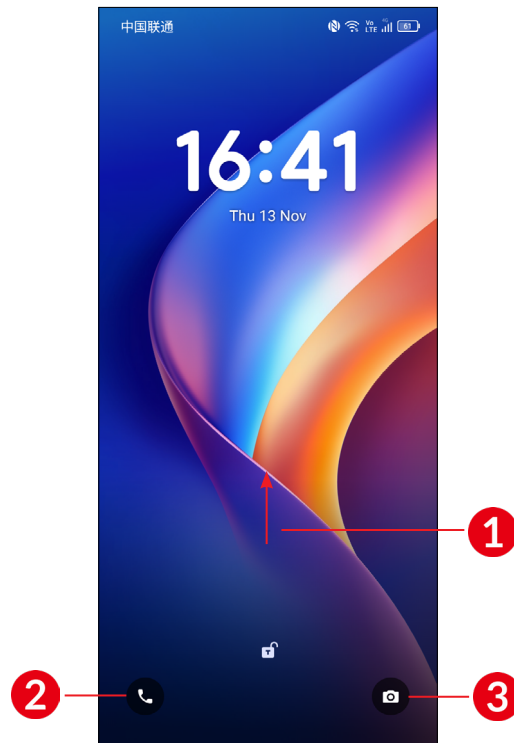

- 1 Swipe up to unlock the screen
- 2 Long press to enter **Phone**
- 3 Long press to enter **Camera**

## Enter a password to unlock the screen

Once the screen is turned on, swipe up from any position on the screen to display the password input panel. Then enter your lock screen password.

## Use pattern unlock

Draw the same pattern you have set to unlock the screen.

## Use face unlock

- From the app list, touch **Settings > Security & privacy > Device unlock > Face & fingerprint unlock > Face unlock**. Before using the face key, you need to set a pattern/PIN/password.
- Hold your phone 8-20 inches from your face. Position your face in the square shown on the screen. For best results, we suggest that the face key is enrolled indoors and away from direct sunlight.

- Enable face unlock when your screen turns on, otherwise you will have to swipe up on the screen first of all.

### Use fingerprint unlock

- Touch the fingerprint sensor (**Settings > Security & privacy > Device unlock > Face & fingerprint unlock > Fingerprint**) with an enrolled finger to unlock the screen.

## Personalizing your Home screen

### Add

You can touch and hold a folder, an application or a widget and drag the item to your preferred Home screen.

### Reposition

Touch and hold an item and drag it to the desired position and then release. You can move items both on the Home screen and the Favourite tray. Hold the icon on the left or right edge of the screen to drag the item to another Home screen.

### Remove

Touch and hold the item and drag it up to the top of the  remove icon, and release after it turns white.

### Create folders

To improve the organisation of shortcuts or applications on the Home screen and the Favourite tray, you can add them to a folder by stacking one item on top of another. To rename a folder, open it and touch the folder's title bar to input the new name.

### Wallpaper customisation

Touch and hold an empty area on the Home screen, then touch **Wallpaper & style** to customise wallpaper.

## Widgets and recently used applications

### Consult widgets

Touch and hold the empty area in the Home screen, then touch **Widgets** to display all widgets.

Touch and hold the widget and slide it to move to your preferred screen.

### Consult recently used applications

To consult recently used applications, swipe up from bottom of the device and hold on. Touch a thumbnail in the window to open the application.

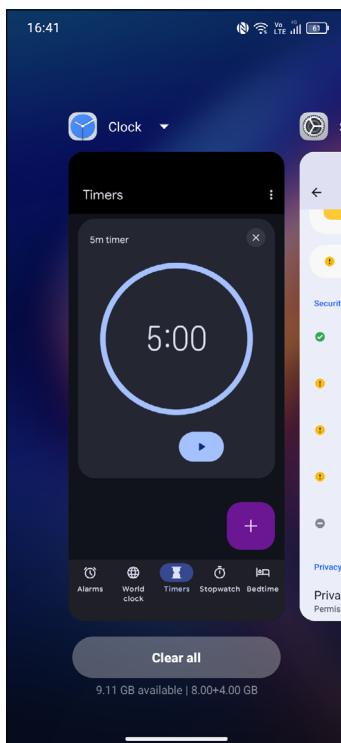

Touch one thumbnail and slide it up to close the application, slide it right/left to switch between the applications.

Touch **Clear all** at the bottom of the screen to close all the running applications.

## Volume adjustment

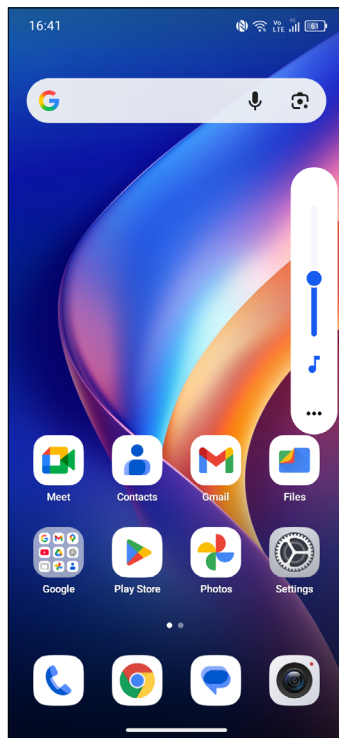

Press the **Volume** key to adjust the volume.

Touch the **•••** icon to adjust Alarm, Notification, Ring and Media volume.

# 1.5 Text input

## Using the Onscreen Keyboard

### Onscreen Keyboard settings

Touch **Settings > System > Keyboard**, touch the keyboard you want to set up and a series of settings will become available.

### Adjust the Onscreen Keyboard orientation

Turn the phone sideways or upright to adjust the onscreen keyboard orientation. You can adjust it by changing the settings (Touch **Settings > Display > Auto-rotate screen**).

- **Gboard**

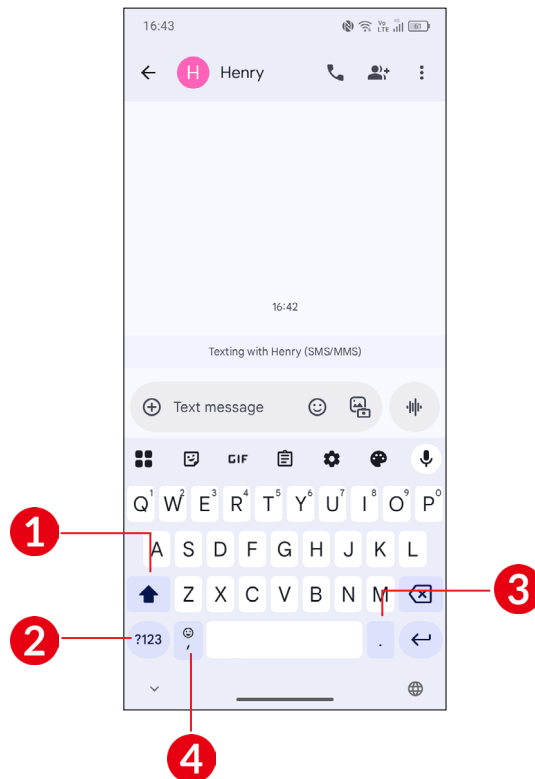

- 1 Touch to switch between "abc/Abc" mode; Touch and hold to switch to "abc/ABC" mode.
- 2 Switch between alphabetical and numeric keyboard.
- 3 Touch and hold to select symbols.
- 4 Touch and hold to show more options.

## Text editing

**You can edit text which you have entered.**

- Touch and hold or double touch within the text you want to edit.
- Drag the tabs to change the amount of text to edit.

**You can also insert new texts if preferred**

- Touch where you want to type, or touch and hold a blank area. The cursor will blink and the tab will appear. Drag the tab to move the cursor.
- If you have cut or copied any text, touch the tab to show the Paste and Select all option which allows you to complete pasting immediately.

# 2 Multimedia applications

## 2.1 Camera .....



Before using the camera, make sure that you remove the protective lens cover to avoid it affecting your picture quality.

### Launch Camera

There are multiple ways to open the Camera app.

#### From the Home Screen

From the Home screen, touch **Camera** .

#### From the Lock Screen

When the screen is locked, press the Power key once to light up the screen, then long press the camera icon in the lower right corner to open the camera.

#### Using a shortcut key

Simply double-press the **Power** key to open the camera.



Drop down in the blank area for more shortcut options





Slide left or right to switch between modes

- 1 Touch for more shortcut options
- 2 Zoom in/out
- 3 Switch between front/back camera
- 4 Take a photo
- 5 Pinch fingers together to zoom out, or spread fingers apart to zoom in
- 6 **Super macro:** Touch to access super macro mode.
- 7 View the photos or videos you have taken

## To take a photo

The screen acts as the viewfinder. First, position the object or landscape in the viewfinder, touch the screen to focus if necessary. Touch  to capture. The photo will be automatically saved. You can also touch and hold  to take burst shots.

## To take a video

Touch **VIDEO** to change the camera mode to video. Touch  to start video recording. Touch the right part of this icon  to take a picture during video recording.

Touch the left part of this icon  to pause video recording and touch  to continue. Touch  to stop recording. The video will be automatically saved.

### Further operations when viewing a photo/video you have taken

- Slide left or right to view the photos or videos you have taken.
- Touch , you can select **Bluetooth**, **Messages**, **Gmail**, etc. to share the photo or video.

## Modes and settings

### Modes

Slide left or right to switch between modes.

- **NIGHT:** Night mode enhances the camera's sensitivity to light, allowing you to capture details that would otherwise be lost in the dark.
- **VIDEO:** Touch to access video mode.
- **PHOTO:** Default mode for Camera.
- **PORTRAIT:** Touch to create a depth of field effect. You can compose an image that highlights your subject while producing a gorgeously blurred background.
- **More:** Tap **MORE** to access more modes.
- **PRO:** Pro camera mode lets you fine-tune parameters and gives you full control over ISO, WB exposure time, aperture, shutter speed and so on.
- **LIGHT TRACE:** Capture creative movements of light using a long exposure photograph.
- **PANO:** Use pano to capture a panoramic photo, an image with a horizontally elongated field of view. Tap the shutter button and move the phone steadily along in the direction indicated on the screen. The photo will be saved when all the slots are filled, or when pressing the shutter button again.
- **TIME LAPSE:** While time-lapses are viewed as videos, they are actually a sequence of raw images. Shoot for 10 minutes and you will get a video with the preset scenario applied.

- **Google Lens** <sup>(1)</sup>: Google Lens is a free tool that uses Google to help you: copy and translate text, search for similar products, identify plants and animals, discover books and media, scan barcodes, and more.

## Settings

Touch  and then  to set more options:

- **AI scene detection:** Touch the switch to activate/deactivate the function. With plenty of different scene detection, the camera will intelligently analyse the scene to optimize the parameters for a perfect shot.
- **Intelligent mode recommendation:** Touch the switch to activate/deactivate the function of recommending appropriate modes based on scenarios.
- **Photo size:** Touch to select photo size.
- **Watermark:** Touch  to turn on/off watermark.
- **Auto HDR:** Touch to turn on/off HDR.
- **Image quality enhancement:** It is an optimization feature that automatically improves the overall quality of captured photos without the need for manual parameter adjustments.
- **Prioritise fast shooting:** Enable this mode to prioritize capturing split-second moments, automatically adjusting shutter speed and minimizing processing delay for seamless action shots.
- **Quick snap:** Set the device to take a photo by pressing the volume down key twice quickly when screen is off.
- **Video quality:** Touch to select video quality.
- **Microphone:** Touch to turn on/off microphone.
- **Touch to shoot:** Click on the preview area to take a photo.
- **Mirror camera:** Touch to turn on/off mirror camera.
- **Gesture to capture:** Use the "palm" gesture to take a photo or video.
- **Gridlines:** Touch to turn on/off gridlines.
- **Camera leveler:** Touch to turn on/off leveler.
- **Volume button function:** Touch to customise the volume button to Shutter, Zoom or Volume when using camera.

<sup>(1)</sup> Your phone must also be connected to a network.

- **Storage:** Touch to choose between phone and SD card storage when an SD card is inserted. The default is internal storage.
- **Save location information:** Turn on  to tag photos and videos with your location. This option is available when the GPS location service is enabled.
- **Shutter sound:** Touch to turn on/off shutter sound when capturing.
- **QR code:** : Touch to turn on/off QR code.
- **Reset settings:** Touch to reset the camera to its factory default settings.
- **Feedback:** Give your feedback on your app.

## 2.2 Photos .....



**Photos** acts as a media player for you to view photos and play videos. In addition, a set of further operations to pictures and videos are available for selection.

To view the photos you have taken, swipe up from Home screen and then touch

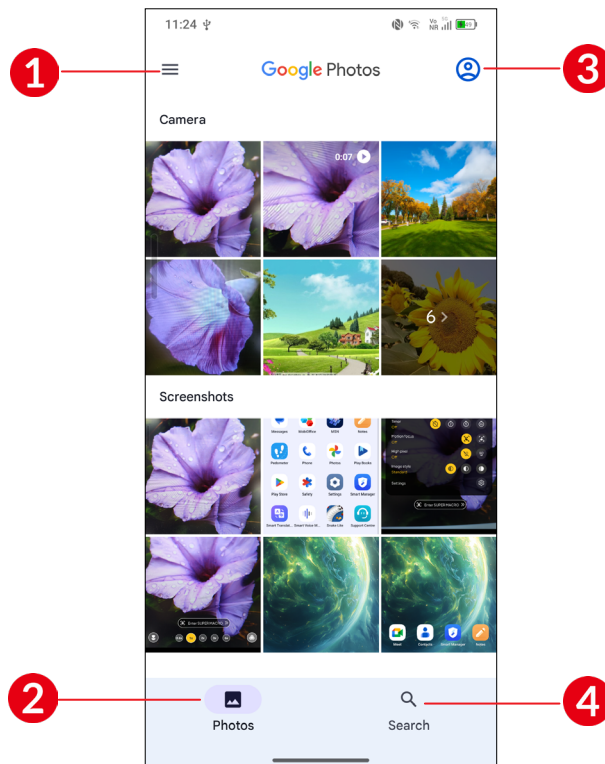





- 1 Tap to access Photos, Bin
- 2 View the photos/videos you have just taken.
- 3 Tap to access more options
- 4 Search your photos

## Working with pictures

You can work with pictures by rotating or cropping them, sharing them with friends, setting them as a contact photo or wallpaper, etc.

Find the picture you want to work on, then tap the picture.



- Tap  to share the picture.
- Tap  to edit the picture.
- Tap  to access Google Lens.
- Tap  to delete the picture.
- Tap  > **Use as** to set the picture as a Contact photo or Wallpaper.

# 3 Apps and features

## 3.1 Phone.....



### Making a call

To make a call, swipe up from Home screen and touch .

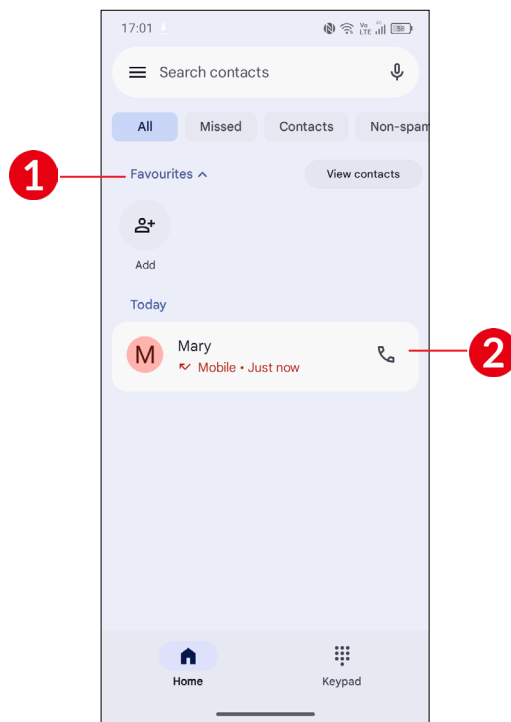

1 Favourite numbers

2 Call logs

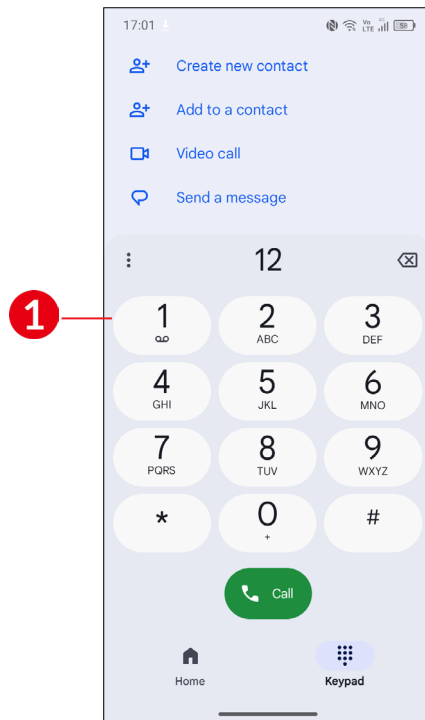

## 1 Touch and hold to access voicemail



Enter the desired number from the dial pad and touch  to place the call or select a contact from **Contacts** or **Call logs** by touching tabs, then make the call.

The number you entered can be saved to **Contacts** by touching **Create new contact** or **Add to a contact**.

If you make a mistake, you can delete the incorrect digits by touching .

To hang up a call, touch .

## International call

To dial an international call, touch and hold  to enter "+", then enter the international country prefix followed by the full phone number and touch .



## Emergency call

If your phone has network coverage, dial the emergency number and touch  to make an emergency call. Depending on your network and country this could even work without a SIM card and without typing in the SIM PIN code.

## Answering or rejecting a call



When you receive a call:

- Press **Answer**, or swipe right the icon  to answer;
- Press **Decline**, or swipe left the icon  to reject;
- Touch **Message**  to reject the call by sending a preset message.

## Calling your voicemail

Your voicemail is provided by your network to avoid missing calls. It works like an answering machine that you can consult at any time.

To access your voicemail, touch and hold .

If you receive a voicemail,  appears on the Status bar. Open the Notification panel and touch **New voicemail**.

## During a call

To adjust the volume during a call, press the **Volume up/down** key.

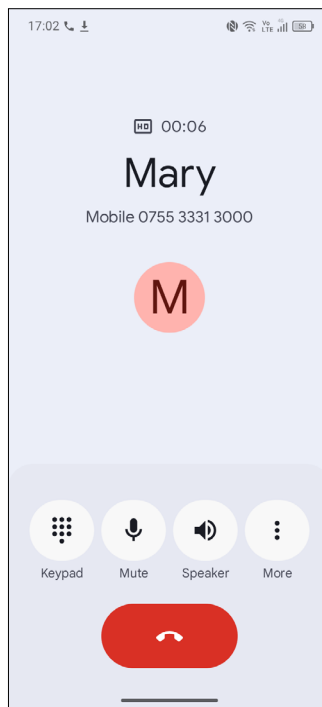

End the current call.



Display the dial pad.



Touch to mute the current call. Touch this icon again to unmute the call.



Touch to activate the speaker during the current call. Touch this icon again to deactivate the speaker.



Tap to show more options.



To avoid accidental operation of the touchscreen during a call, the screen will be locked automatically when you put the cellphone close to your ear; and it will be unlocked when the cellphone is taken away from your ear.

## Managing multiple calls

With this phone you can handle multiple calls at the same time.

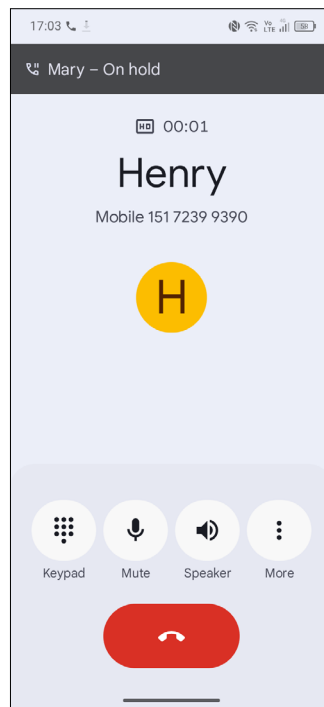

### Swap calls

When you accept two calls, touch and then to switch between two lines. The current call will be put on hold and you are able to join the other call.

### Conference calls<sup>(1)</sup>

You can set up a conference call as follows.

- Place a call to the first participant of the conference call.
- Touch and then to add another call.
- Enter the phone number of the person you want to add to the conference and touch . You can also add participants from Call logs or Contacts.
- Touch to merge calls.
- Touch to end the conference call and disconnect all callers.

### More options

Touch from the **Phone** screen, you can access phone settings, view call history, etc.

<sup>(1)</sup> Depending on your network operator.

## 3.2 Contacts.....



**Contacts** enables quick and easy access to the contact you want to reach.

You can view and create contacts on your phone and synchronize these with your Gmail contacts or other applications on the web or on your phone.

### Consult your Contacts

To see your contacts, touch  from the Home screen.

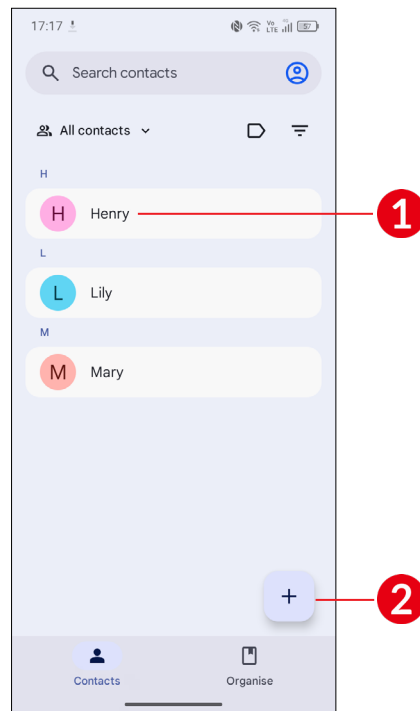

- 1** Touch to open the Quick contact panel  
Touch and hold to share or delete the selected contact

- 2** Add new contacts

 Deleted contacts will also be removed from other applications on the phone or web the next time you synchronize your phone.

## Adding a contact

Touch **+** in the contact list to create a new contact.

You are required to enter the contact's name and other contact information. By scrolling up and down the screen, you can move from one field to another.

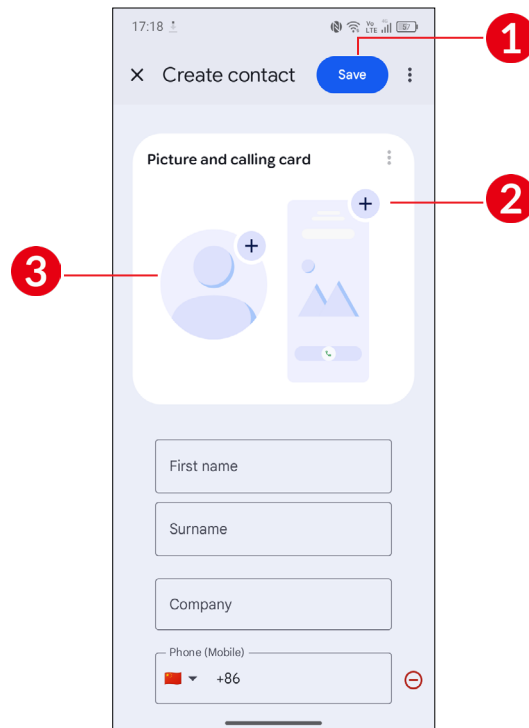

- 1 Touch to save
- 2 Select a picture or take a photo for the calling card
- 3 Select a picture or take a photo for the Phone contact

### Add to/remove from Favourite s <sup>(1)</sup>

To add a contact to Favourite s, you can touch a contact to view details then touch  to add the contact to Favourite s.

To remove a contact from Favourite s, touch  on the contact details screen.

## Editing your contacts

To edit contact information, touch  in the contact details screen.





When finished, touch **Save**.

<sup>(1)</sup> Phone and Gmail contacts can be added to Favourite s.

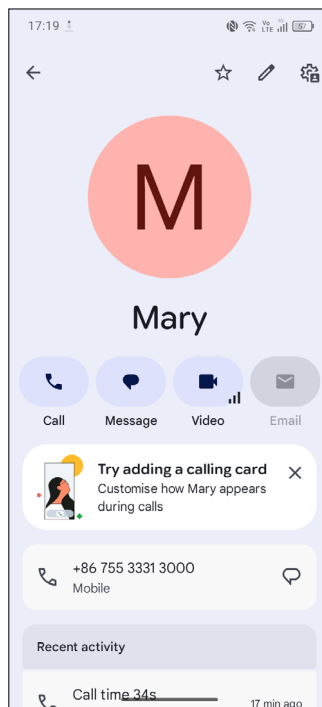
## Using the Quick contact panel

Touch a contact to open the Quick contact panel.



- Touch  or the number to make a call.
- Touch  to send a message.
- Touch  to make a video call.
- Touch  to send an email.

The icons available on the Quick contact panel depend on the information you have for the contact and the applications and accounts on your phone.

## Sharing contacts

You can share a single contact or contacts with others by sending the contact's vCard to them via Bluetooth, Gmail, etc.

- From the Contacts screen, touch and hold a contact and touch .
- Select the application to perform this action.

## Accounts

Contacts, data or other information can be synchronised from multiple accounts, depending on the applications installed on your phone.

To add an account, touch  from the contacts list and touch **contacts settings > Accounts > Add account**, or from the Home screen, touch **Settings > Accounts > Add account**.

You are required to select the kind of account you are adding, like Google, etc.

As with any other account setup, you need to enter detailed information, like username, password, etc.

You can remove an account and all associated information from the phone. Touch the account you want to delete, touch **Remove account**, then confirm.

### Auto-sync

On the **Accounts** screen, turn on **Automatically sync app data**. When activated, all changes to information on the phone or online will be automatically synchronised with each other.

## 3.3 Messages .....



### Writing a new message

You can create, edit, send and receive SMS and MMS with this phone.

To access Messages, touch  from the App drawer.

On the message list screen, touch **Start chat** to write text/multimedia messages.

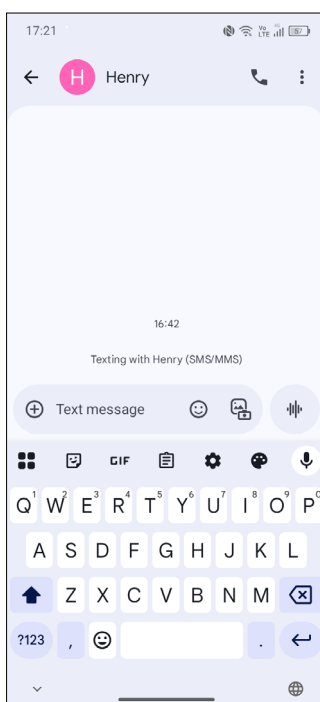

## Sending a text message

- To add recipients, enter a mobile phone number or select a contact in the **To** bar.
- Touch the **Text message** bar to enter the text of the message.
- When finished, touch  to send the text message.





Specific letters (accented) will also increase the size of the SMS. This may cause multiple SMS to be sent to your recipient.

## Sending a multimedia message

MMS enables you to send video clips, images, photos, animations, slides and sounds to other compatible mobiles and e-mail addresses.

An SMS will be converted to MMS automatically when media files (image, video, audio, slides, etc.) are attached or subject or email addresses are added.

- To send a multimedia message, enter the recipient's phone number in the **To** bar.
- Write the text of the message in the **Text message** bar.
- Touch  to access to your location, send a contact or attach files.
- Touch  to take a photo/video or attach a photo/video you have taken.
- When finished, touch  to send the multimedia message.

## Manage messages

When receiving a message,  will appear on the Status bar as a notification. Drag down the Status bar to open the Notification panel. Touch the new message to open and read it. You can also access the **Messages** application and touch the message to open it.

Messages are displayed as a conversation.

Touch a message to enter the message composing screen:



- 1 Touch for more options
- 2 Touch to call the number
- 3 Touch to view the contact details if the number has been saved

To adjust message settings, touch the round icon  in the upper right of message list screen and then select **Messages settings**.

## 3.4 Switch Phone.....



**Switch Phone** offers an efficient and convenient way to transfer data from your old device to your new one.

To access this menu, swipe up on the home screen or open the **Tool** folder to find **Switch Phone** , then transfer data by following the onscreen instructions.

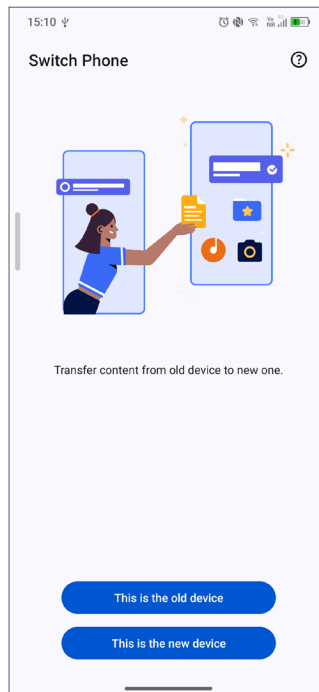

## 3.5 Clock.....



Your mobile phone has a built-in clock.

To view the current time, swipe up the Home screen, then touch **Clock**.

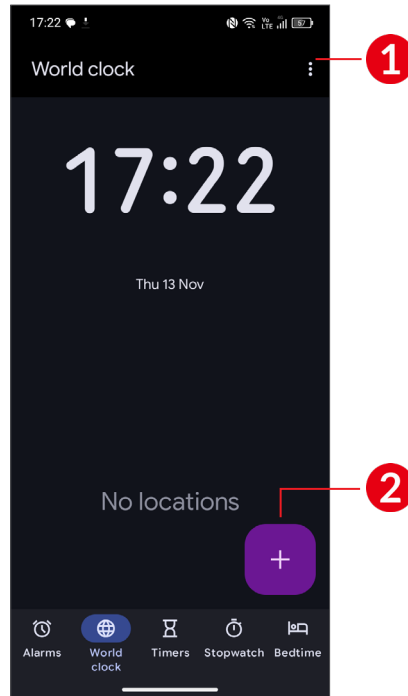



**1** Touch to access clock and alarms settings.

**2** Touch to add a city

### Alarms

From the Clock screen, touch **Alarms** to enter.

- Turn on  to enable the alarm.
- Touch  to add a new alarm, touch **OK** to save.
- Touch a currently existing alarm to enter the alarm editing screen, touch **Delete** to delete the selected alarm.

## 3.6 TCL apps

**Support Center**.....



Support Centre helps you to learn more about Hot FAQs, operation instructions, troubleshooting, etc. Use it to send us your feedback.

## 3.7 Other applications <sup>(1)</sup>

The previous applications in this section are preinstalled on your phone. To download and install more 3rd party applications, use the Google Play Store application.

## 3.8 Google applications <sup>(1)</sup>

Google apps are preinstalled on your phone to improve work efficiency and help you enjoy life.

This manual briefly introduces the apps. For detailed features and user guides, refer to the related websites or the introduction provided in the apps.

You are recommended to register with a Google account to enjoy all the functions.

### Gmail

As Google's web-based email service, Gmail is configured when you first set up your phone. With this application you can send and receive emails, manage emails by labels, archive emails, etc. Emails can be automatically synchronised with your Gmail account.

### Maps

Google Maps offers satellite imagery, street maps, 360° panoramic views of streets, real-time traffic conditions, and route planning for traveling by foot, car, or public transportation. By using this application, you can find your own location, search for a place, and get suggested route planning for your trips.

<sup>(1)</sup> Application availability depends on country and operator.

## Photos

Google Photos stores and backs up your photos and videos. It also automatically analyses photos and organizes them into groups, so that you can quickly find the photos you need.

## Meet

Stay connected and collaborate effortlessly with the Meet menu on your smartphone. Join or schedule video meetings and group calls with ease.

## YouTube

YouTube is an online video-sharing application where users can upload, view, and share videos. Available content includes video clips, TV clips, music videos, and other content such as video blogging, short original videos, and educational videos. It supports a streaming function that allows you to start watching videos almost as soon as they begin downloading from the internet.

## Play Store

Serves as the official app store for the Android operating system, allowing users to browse and download applications and games. Applications are either free of charge or at a cost.

In Play Store, search for the app you need, download it and then follow the installation guide to install the app. You can also uninstall, update an app, and manage your downloads.

## Google

A web browser with which you can surf the internet.

Your bookmarks, browsing history, and settings across all devices on which the browser is installed can be synchronised with your Google account.

## Files

Files displays all data stored on the phone, such as applications, media files downloaded from Google Play Store, YouTube or other locations; Videos, pictures or audios you have captured; other data transferred via Bluetooth, USB cable, etc.

## **Find Device**

Find Device helps you to find your lost device, wipe lost device data remotely, and perform a host of other security functions.

## **Keep Notes**

Keep Notes allows you to create, manage, and access your notes effortlessly. Capture your ideas, to-do lists, and important reminders with ease.

# 4 Settings.....



To go to **Settings**, touch  from the Home screen.

You can also swipe down from the right side of the status bar to open the Quick settings panel and touch .

## 4.1 My device

This menu helps you learn about your device, including device name, RAM, Storage, Display, Camera and Battery information, CUP type, etc.

## 4.2 Wi-Fi

You can connect to the internet when your phone is within range of a wireless network. Wi-Fi can be used on your phone even without a SIM card inserted.

### To turn Wi-Fi on and connect to a wireless network

- Touch **Settings** > **Wi-Fi**.
- Turn on .
- Once Wi-Fi is turned on, detected Wi-Fi networks are listed.
- Touch a Wi-Fi network to connect to it. If the network you selected is secured, you are required to enter a password or other credentials (you should contact the network operator for details). When finished, touch **Connect**.

### To add a Wi-Fi network

When Wi-Fi is on, you can add new Wi-Fi networks according to your preference.

- Touch **Settings** > **Wi-Fi** > **Add network**.
- Enter the name of the network and any required network information.
- Touch **Connect**.

### To forget a Wi-Fi network

The following steps prevent automatic connection to networks which you no longer wish to use.

- Turn on Wi-Fi, if it's not already on.
- On the Wi-Fi screen, touch the name of the saved network.
- Touch **Forget** in the dialog that opens.

## 4.3 Bluetooth

Bluetooth is a short-range wireless communication technology that you can use to exchange data, or connect to other Bluetooth devices for various uses.

### To turn on Bluetooth

- Touch **Settings > Bluetooth**.
- Turn on .

Your device name will appear on screen.

### To rename your device

- Touch **Settings > Bluetooth**.
- Touch **Device name**.
- Enter a name, and touch **Rename** to confirm.

### To pair/connect your phone with a Bluetooth device

To exchange data with another device, you need to turn Bluetooth on and pair your phone with the Bluetooth device with which you want to exchange data.

- Touch **Settings > Bluetooth**.
- Touch a Bluetooth device you want to pair your phone with in the list.
- In the dialog that pops up, touch **Pair** to confirm.
- If the pairing is successful, your phone will be connected to the device.

### To unpair from a Bluetooth device

- Touch  beside the device you want to unpair from.
- Touch **Forget** in the dialog that opens, and then touch **Forget device** to confirm.

## 4.4 Network & internet

Manage your mobile connectivity effortlessly. View detailed SIM card information for flexible network configurations.

## 4.5 Connections

### Aeroplane mode

Turn on **Aeroplane mode**  to simultaneously disable Wi-Fi and other wireless connections.

### NFC

Turn on  to enable NFC.

The function allows data exchange when the phone touches another device.

### Cast

You can use Cast to display your device's screen on your TV, and display content like TV shows, movies, photos, games, and websites from supported apps.

### USB

With a USB cable, you can charge your device, transfer files or photos (MTP/PTP) between your phone and a computer.

#### To connect your phone to the computer

- Use the USB cable that came with your phone to connect the phone to a USB port on your computer. You will receive a notification that the USB is connected.
- Open the Notification panel and choose the way which you want to transfer files or touch **Settings > Connections > USB** to select. By default, **No data transfer** is selected.



Before using MTP, make sure that the driver (Windows Media Player 11 or higher version) has been installed.

### Printing

You can select your default print service and add service.

## Hotspot & tethering

To share your phone's data connection via Wi-Fi, Bluetooth and USB, or as a mobile hotspot, go to **Settings > Connections > Hotspot & tethering** to activate these functions.

### To rename or secure your mobile hotspot

When your mobile hotspot is activated, you can rename your phone's Wi-Fi network (SSID) and secure its Wi-Fi network.

- Touch **Settings > Connections > Hotspot & tethering > Mobile hotspot**.
- Touch **Hotspot name** to rename the network SSID or set your network security.
- Touch **OK**.



The functions above may incur additional network charges from your network operator. Extra fees may also be charged in roaming areas.

## Data usage

Check your mobile data consumption details and set mobile data limit. Your mobile data connection will be disabled when the specified limit is reached. You can also choose a data usage cycle to view the statistics and related applications of used data by your phone.



Data usage is measured by your phone, and your operator may count differently.

## VPN

Virtual private networks (VPNs) allow you to connect to the resources inside a secured local network from outside that network. VPNs are commonly deployed by corporations, schools, and other institutions so that their users can access local network resources when not inside that network, or when connected to a wireless network.

### To add a VPN

- Touch **Settings > Connections > VPN** and then touch .
- On the screen that opens, follow your network administrator's instructions to configure each component of the VPN settings.
- Touch **SAVE**.

The VPN is added to the list on the VPN settings screen.



Before adding a VPN, you should set a screen lock for your phone.

### To connect to/disconnect from VPN

To connect to a VPN:

- Touch **Settings** > **Connections** > **VPN**.
- The VPNs you have added are listed. Touch the VPN you want to connect with.
- In the dialog that opens, enter any requested credentials and touch **Connect**.

To disconnect from a VPN:

- Touch the VPN you want to disconnect from. In the dialog that opens, touch **Disconnect**.

### To edit/delete a VPN

To edit a VPN:

- Touch **Settings** > **Connections** > **VPN**.
- The VPNs you have added are listed. Touch the  icon next to the VPN you want to edit.
- After editing, touch **Save**.

To delete a VPN:

- Touch the  icon next to the selected VPN, then touch **Forget** to delete it.

## Private DNS

Touch to select private DNS mode.

## Chromebook

You can connect your phone to a Chromebook to instantly access your phone's data on the computer.

## Cross-device services

Cross-device services enables connection and collaboration between your phone and other devices. Set it according to the on-screen steps.

## Quick Share

Share files with nearby devices.

## Android Auto

Android Auto makes it possible to control many of the functions available in your phone via the car's centre display.

## 4.6 Wallpaper & style

Access your phone's Wallpaper & style menu to personalize your device's look easily. Here, you can select your favourite wallpaper, matching themes, and customize system colours to suit your taste. You can also adjust display size and text settings to make on-screen content more comfortable for you to view.

## 4.7 Home screen & lock screen

With this menu, set your home apps, choose your Favourite wallpapers and theme styles, etc.

## 4.8 Display

### Brightness level

Adjust screen brightness manually.

### Adaptive brightness

When enabled, optimizes screen brightness for the light available in your environment.

### Darker display mode

In a low-light environment, turn on darker display mode to achieve lower screen brightness.

## Mode

Select Light mode or Dark mode to adapt to different preferences and environments.

## Dark mode settings

This menu lets you control your phone's dark theme, which uses darker colors for screens to reduce eye strain, especially in low light. Here, you can turn dark mode on/off, set it to activate automatically (like at sunset or on a schedule).

## Eye comfort mode

**Eye comfort mode** can effectively reduce blue light radiation and adjust the color temperature to relieve eye fatigue. You can also create a custom schedule to turn it on.

## Reading mode

Optimize the screen display to make the reading experience as comfortable as physical books.

## NXTVISION

### Image enhancement

Enhance image contrast automatically, sharpness and dark details.

### Video enhancement

Enhance the color, contrast and depth of detail of video to bring a cinema-grade visual experience.

### Game enhancement

Improve the shadow detail and enhance overall gaming graphics.

## Colour mode & temperature

Change the display gamut to vivid, natural or advanced based on content.

## Sleep

Set screen timeout.

## **Refresh rate**

Select the refresh rate of the screen. When a high refresh rate is set, the screen will scroll more smoothly. When you select a standard refresh rate, you can use the battery longer.

## **High brightness mode**

This feature enhances screen visibility in bright environments, such as direct sunlight, by making the screen easier to read.

## **Colour contrast**

This menu provides different colours between text, icons, and their backgrounds on your phone. You can choose the contrast to your preference, making content easier to read. This feature enhances screen readability across various lighting conditions.

## **Display size and text**

Adjust font size, display size and text manually.

## **Auto-rotate screen**

Select whether the screen rotates automatically or not.

## **Status bar & notch**

Set the style of the status bar, select whether notification icons are folded and how the battery percentage is displayed.

Turn on the notch for full screen apps to get the best experience on the phone.

## **When device is in VR**

When using your phone with a VR, you can choose Reduce blur (the recommended setting for sharper visuals) or Reduce flicker. Selecting the right option helps enhance your virtual reality experience to reduce potential visual distractions.

## **Screen saver**

Choose a screen saver and use it while charging.

## 4.9 Sound & vibration

Use the Sound settings to configure many aspects of call ringtones, music, and other audio settings.

### Phone ringtone

Set your incoming call ringtone.

### Notification ringtone

Set the default sound for notifications.

### Alarm ringtone

Set your alarm ringtone.

### DTS Sound

Touch to activate DTS sound, which creates an immersive sound quality experience based on different scenarios.

### Live Caption

Live Caption automatically generates real-time captions for audio content on your phone, including calls, videos, podcasts, etc. It helps make audio content more accessible, letting you follow along visually without needing to hear the sound.

### Modes

Access modes to quickly enable Do Not Disturb, set Bedtime or create your own mode.

### Vibration & haptics

Set vibration for calls, notifications, etc.

### More sound settings

Set dial pad tones, screen locking sound, touch sounds, etc.

## 4.10 Notifications

In the **Notifications** menu, you can configure whether to block the notifications from this app, hide sensitive content, etc.

## 4.11 Battery

The **Battery** menu is a key section in your phone settings for monitoring and managing battery life. Here, you can check your current battery level, view which apps are using the most power, and enable power-saving modes to extend battery life when it's low. You can also set up battery optimization for specific apps to prevent excessive drain.

## 4.12 Smart Manager

**Smart Manager** ensures your phone is operating in top form by automatically scanning and optimizing data usage to preserve battery levels, manage storage and protect against security threats.

Restricting auto-launch apps can make the system run faster and extend battery life.

You can also do some options manually for further optimization.

## 4.13 Storage

Enter **Settings > Storage** to check the usage of storage space and free up more when necessary.

## 4.14 Apps

Touch to view details about the applications installed on your phone, to manage their data usage or force them to stop.

## 4.15 Advanced features

### NXTURBO & RAM expansion

Boost your phone's performance with NXTURBO, optimising speed and efficiency for smoother multitasking. RAM expansion allows you to allocate storage as virtual RAM, enhancing overall system performance for demanding apps and games. Customise settings to suit your usage needs.

### Sidebar

Access your favourite apps, tools, and shortcuts instantly with the Sidebar. This convenient feature allows you to multitask efficiently by keeping essential functions within easy reach. Customise the Sidebar to suit your preferences and streamline your mobile experience.

### Quick Gestures

To set some gestures for convenient use, such as 3-finger screenshot.

### Power key

#### Quickly open camera

To quickly open camera, press the power button twice. It works from any screen.



#### Power button ends call

Press the power button to end a call.

#### Long press power key

To access digital assistant, long press the power key.

### Screen Recorder

Set the video resolution, sound, etc. To use Screen Recorder, Swipe down the Status bar to access the Quick Settings panel and touch , then drag  up to the quick settings panel, exit from edit screen and touch the new added title.

## 4.16 Security & privacy

### App security

Play Protect regularly checks your apps and device for harmful behavior. You'll be notified of any security risks found.

### Device unlock

#### Screen lock

Select one method such as **Swipe, Pattern, PIN** or **Password** to unlock the screen.

#### Face & Fingerprint unlock

- **Face unlock**

**Face unlock** allows you to unlock your device with your facial data. Set it according to the on-screen steps.

Ensure that you are facing the phone screen when using face recognition.

- **Fingerprint**

Use your fingerprint to unlock the screen.

Set it according to the on-screen steps.

**NOTE:** You need to set a pattern, PIN, or password before using face & fingerprint unlock.

#### Theft Protection

Safeguard your device with advanced theft protection features. Remotely lock, track, or wipe your phone in case of loss or theft, ensuring your personal data remains secure.

### Account security

Touch to check up Google account security.

### Device finders

Find My Device helps you locate this device remotely. If you lose this device, it also helps you keep your data safe.

## **System and updates**

Touch to check for security updates and update Google Play system.

## **Privacy controls**

To protect your privacy, you can set an app to be allowed or forbidden access to your location, SMS, phone, etc. Also whether or not to show passwords, choose the activities and info that you want Google to save.

## **Privacy dashboard**

Gain full visibility into your app permissions and data access with the Privacy Dashboard. Easily monitor and manage which apps are accessing your location, camera, microphone, and more. Take control of your privacy with clear insights and quick actions to protect your personal information.

## **Advanced Protection**

Advanced Protection helps defend against online attacks, harmful apps, insecure connections, spam calls and other threats that put your data at risk. Turn on device protection for the strongest security and privacy.

## **More security and privacy**

More security and privacy settings are available under this menu.

## **4.17 Location**

Touch to set whether to allow an app to access your device's location. You can set to allow continual access, or only while the app is in use.

## **4.18 Safety & emergency**

To protect yourself in emergency, you can set emergency information such as medical information, emergency contacts in advance. You can also use SOS or turn on location and wireless emergency alerts.

## 4.19 Accounts

Touch to add, remove, and manage your email and other supported accounts. You can also use these settings to control the options for how all applications send, receive and synchronize data; i.e. if this is done automatically, according to a schedule for each app, or not at all.

Touch **Add account** to add an account for the selected app.

## 4.20 Digital Wellbeing and parental controls

In this menu you can find how much time you have spent on the phone and even on each app. You can customise the time limit for using the phone to ensure a healthy and balanced life.

In addition, parents are able to restrict their children's usage time to manage their browsing habits.

## 4.21 Google

Touch to configure your Google account and service settings.

## 4.22 Accessibility<sup>(1)</sup>

### Accessibility Menu

The Accessibility Menu offers quick access to frequently used accessibility features, such as quick settings adjustments for display brightness or volume, take screenshots, etc.

### Select to Speak

Once this feature is activated, as you select each item on the screen, the device provides spoken feedback, describing aloud what appears.

<sup>(1)</sup> Application availability may vary depending on the country and operator.

## Switch Access

Switch Access enables you to control your device if it is difficult to directly interact with the touch screen. A switch can be externally connected to your device, like a keyboard or large button.

## TalkBack

TalkBack is a screen reader that provides spoken feedback to help you navigate your device. With TalkBack, you can interact with your phone entirely by touch, as it describes each element you tap and guides you through your actions, so that you can use your device without looking at the screen.

## Display size and text

Adjust the display size and text settings to customize the size of on-screen elements to suit your visual preferences and needs.

## Colour and motion

The Colour and motion settings allow you to modify how colors are displayed on your screen and control visual animations. You can choose from various color filters to enhance color perception, reduce eye strain, or accommodate color blindness. Additionally, you can disable unnecessary animations for a smoother visual experience.

## Extra dim

Extra dim lowers the screen brightness beyond the normal minimum level, providing a softer display for use in low-light environments or for users who are sensitive to bright screens. This feature helps reduce eye fatigue and makes it more comfortable to use your phone in the dark.

## Magnification

Magnification lets you zoom in on specific areas of your screen. You can activate magnification using gestures or the Accessibility Menu. Once enabled, you can magnify text, images, and other content to see details more clearly, which is particularly helpful for users with low vision.

## Timing controls

Timing controls allow you to adjust the timing of system feedback, such as button presses or keyboard responses to better suit your needs, especially if you require more time to interact with on-screen elements.

## System controls

System controls provides alternative ways to control system settings, such as navigation mode, power button ends call and Auto-rotate screen.

## Vibration & haptics

You can set the vibration for notifications, calls, touch interactions and so on, or choose to disable vibrations altogether if you prefer.

## Live caption

Live caption automatically generates captions for audio content, such as calls, videos, or podcasts. This feature makes audio content more accessible for users with hearing impairments or those who prefer to read along while listening.

## Caption preference

Caption preference allows you to customize caption size and style to make the captions more readable and visually appealing according to your preferences.

## Audio description

Audio description provides spoken descriptions of the visual content in videos, movies, and other media, making visual media more accessible and enjoyable for users with visual impairments.

## Flash notification

Uses your phone's camera flash or screen flash to alert you of incoming calls, messages, and other notifications. When enabled, the flash will blink whenever a new notification arrives, providing a visual cue that can be especially useful for users with hearing impairments or in noisy environments.

## Hearing devices

The Hearing devices section allows you to connect and manage compatible hearing aids or other audio assistive devices with your phone. Improves audio quality and accessibility for users with hearing aids.

## Audio adjustment

Turn on/off mono audio and adjust the balance between left and right audio channels to make audio content clearer and more comfortable to listen to.

## Accessibility shortcuts

Accessibility shortcuts provide quick ways to enable or disable specific accessibility features.

## Text-to-speech output

Text-to-speech output converts written text into spoken words, allowing you to customize the speech rate, pitch, and language for the function. This feature benefits users who prefer auditory feedback or have difficulty reading.

# 4.23 System

## System Update

If you want to update the system, touch **Check for updates** (refer to "5 Making the most of your phone > FOTA upgrade").

## Update apps

Check app update information.

## Languages & region

Under the **Languages & region** menu, you can customize your phone's language and regional settings to align with your preferences. Here, you have the flexibility to adjust the main system language or even set specific languages for individual apps. You can also select your region, temperature formats, measurement systems and the first day of the week etc.

## Navigation mode

Select your favorite navigation button layout.

## Keyboard

Touch to configure the on-screen keyboard, pointer speed, etc.

## Date & time

Use Date & time settings to customise your preferences for how date and time are displayed.

## Backup

Select and confirm to back up your phone's settings and other application data to Google servers. If you replace your phone, the settings and data you've backed up will be restored onto the new phone when you sign in with your Google account.

## Users

Allow multiple users and share your device by adding new users. Each user has a personal space on your device for custom Home screens, accounts, apps, settings and more.

## Reset options

Touch to reset all network settings and app preferences, you won't lose your data with these settings.

If **Erase all data (factory reset)** is selected, all data in your phone's internal storage will be erased, please back up your data before reset.

## Regulatory & safety

Touch to view product information such as **Product model**, **Manufacturer address**, **IMEI**, **CU reference**, **Bluetooth Design Number**, etc.

# 5 Making the most of your phone

## FOTA upgrade

Use the FOTA (Firmware Over The Air) upgrade to update your phone's software.

To access updates, from the app list, touch **Settings > System > System Update**. Turn on data connection or Wi-Fi before searching for updates.

With Wi-Fi turned on, the system is able to discover if a new firmware version is available and if so, begin to download and install it automatically.

If **Settings > System > System Update > ⋮ > Update settings > Automatically update** is turned off, a pop up dialog will ask if you want to download a new firmware version which the phone has discovered, or if you want to ignore it.

During FOTA downloading or updating, to avoid errors in locating the correct update packages, do not change your default storage location.

# 6 Troubleshooting

Before contacting the service centre, here are some instructions to help you troubleshoot your device:

- For optimal operation, fully charge the battery.
- To improve the phone's performance, remove unnecessary files or apps on your phone.
- Update your phone's software via **Settings > System > System Update**.
- Reset your phone via **Settings > System > Reset options > Erase all data (factory reset)**. All your phone data will be lost permanently. It is strongly advised to fully back up your phone data before resetting.

and carry out the following checks:

## My phone can't be switched on or is frozen

- When the phone can't be switched on, charge for at least 20 minutes to ensure the minimum battery power needed. Then switch it on again.
- When the phone falls into a loop during power on animation and the user interface can't be accessed, press and hold the **Power** key to reset. This eliminates any abnormal OS booting issues caused by third party applications.

## My phone has not responded for several minutes

- If your phone doesn't respond, turn off your phone by pressing and holding the **Power** key until it turns off and then restart it again.
- If it still doesn't work, reset the phone.

## My phone turns off by itself

- Check that your screen is locked when you are not using your phone, and make sure that the **Power** key is not accidentally pressed while the screen is unlocked.
- Check the battery charge level.
- If it still doesn't work, reset the phone or update software.
- If the issue occurs while using a certain third-party app, make sure the app is compatible with your device and Android version. Try uninstalling the third-party app.

## My phone can't charge properly

- Make sure that you are using the charger it meets all applicable standards.
- Make sure that your battery is not completely discharged; if the battery power has been empty for a long time, it may take around 20 minutes to display the battery charging indicator on the screen.
- Make sure that charging is carried out under normal conditions 0°C (32°F) to 45°C (113°F).
- When abroad, check that the voltage input is compatible.

## My phone can't connect to a network or "No service" is displayed

- Check your phone's internet connection settings.
- Make sure that you are in a place with network coverage.
- Try connecting to the network by moving to another physical location.
- Verify the network coverage with your operator.
- Check with your operator that your SIM card is valid.
- Try connecting at a later time if the network is overloaded.
- Try to turn on "Aeroplane mode" for a few seconds, then turn Aeroplane mode off.

## Invalid SIM card

- Make sure that the SIM card has been correctly inserted.
- Make sure that the chip on your SIM card is not damaged.
- Make sure that the service of your SIM card is available.

## My phone can't make outgoing calls

- Make sure that you have dialed a valid number and have touched .
- For international calls, check the country and area codes.
- Make sure that your phone is connected to a network, and the network is not overloaded or unavailable.
- Check your subscription status with your operator (credit, SIM card valid, etc.).
- Make sure that you have not barred outgoing calls.

- Make sure that your phone is not in **Aeroplane mode**.

### **My phone can't receive incoming calls**

- Make sure that your phone is switched on and connected to a network (check for overloaded or unavailable network).
- Check your subscription status with your operator (credit, SIM card valid, etc.).
- Make sure that you have not forwarded incoming calls.
- Make sure that you have not barred certain calls.
- Make sure that your phone is not in **Aeroplane mode**.

### **The caller's name/number doesn't appear when a call is received**

- Check that you have subscribed to this service with your operator.
- Your caller may have concealed his name or number.

### **I can't find my contacts**

- Make sure that your SIM card is not broken.
- Make sure that your SIM card is inserted properly.

### **The sound quality of the calls is poor**

- Adjust the volume during a call by pressing the **Volume** key.
- Check the network strength. Move to a location with stronger signal strength.
- Make sure that the receiver, connector and speaker on your phone are clean.

### **I can't use the features described in the manual**

- Check with your operator to make sure that your subscription includes this service.
- Make sure that this feature doesn't require a TCL accessory.

### **When I select a number from my contacts, the number can't be dialed**

- Make sure that you have correctly recorded the number in your contacts.
- Make sure that you have selected the country code when calling an international number.

### **I can't add a contact**

- Make sure that your SIM card contacts are not full; delete some contacts or save the contacts to the phone.

### **My callers can't leave messages on my voicemail**

- Contact your network operator to check service availability.

### **I can't access my voicemail**

- Make sure that your operator's voicemail number is correctly entered in **Voicemail number**.
- Try later if the network is busy.

### **I can't send and receive MMS**

- Check your phone storage as it might be full.
- Contact your network operator to check service availability and MMS parameters.
- Verify the server centre number or your MMS profile with your operator.
- The server centre may be swamped. Try again later.

### **SIM card PIN locked**

- Contact your network operator to obtain the PUK (Personal Unblocking Key) code.

### **I can't connect my phone to my computer**

- Check to make sure the USB port is not broken. If it's not working, try another USB port on your computer.
- Make sure USB drivers are properly installed.
- If you are using a Windows computer, make sure it supports MTP mode. If you are using a Mac, make sure to install Android File Transfer from [www.android.com/filetransfer/](http://www.android.com/filetransfer/).

### **I can't download new files**

- Make sure that there is sufficient phone storage space for your download.
- Check your subscription status with your operator.

### **The phone can't be detected by others via Bluetooth**

- Make sure that Bluetooth is turned on and your phone is visible to other users.
- Make sure that the two phones are within Bluetooth's detection range.

### **The battery drains too fast**

- Make sure that you follow the complete charge time (minimum 120 minutes).
- After a partial charge, the battery level indicator may not be exact. Wait for at least 20 minutes after removing the charger to obtain an exact indication.
- Adjust the brightness of screen as appropriate.
- Extend the email auto-check interval for as long as possible.
- Update news and weather information on manual demand, or increase their auto-check interval.
- Exit background-running applications if they are not being used for extended periods of time.
- Turn off Bluetooth, Wi-Fi, or GPS when not in use.

### **The phone becomes warm following prolonged calls, game playing, internet surfing or running other complex applications**

- This heating is a normal consequence of the CPU handling excessive data. Ending the above actions will make your phone return to normal temperature.

### **After a factory data reset is performed, I can't use my phone without entering Google account credentials**

- After a reset is performed, you must enter the original Google account credentials that were used on this phone.
- If you don't remember your Google account credentials, complete Google account recovery procedures.
- If you still cannot access your phone, apply to the authorized repair centre, but remember that it will not be regarded as a warranty case.

### **I forgot some passwords/codes/keys on my phone**

- Perform a factory data reset.
- If you still cannot access your phone, apply to the authorized repair centre, but remember that it will not be regarded as a warranty case.

## No action after touching the touch screen

- Check whether there is any damage to the screen. If yes, please back up your data and take your device and proof of purchase to our repair centre to get more professional technical assistance.
- If the issue occurs while using a third-party app, make sure the app is compatible with your device and Android version. Try uninstalling the third-party app.
- Check if the issue occurs during charging. If yes, we recommend trying the official charger and data cable.

(Note: The voltage instability of non-standard chargers and data cables may cause the touchscreen to become unresponsive).

- Make sure the temperature where the device is being used is neither too hot nor too cold. The standard working temperature of the capacitive touchscreen is  $-10^{\circ}\text{C}\sim 60^{\circ}\text{C}$ . Excessively high or low temperatures will cause the touchscreen to become unresponsive.
- If there is a screen protector on the screen, see if the touchscreen works after removing it.
- Make sure there are no stains such as water or sweat on the touchscreen. If there are, wipe the screen and try again.
- If it still doesn't work, reset the phone or update software.

## Cannot turn on camera flash mode

- Charge your device until the battery level is at least 30%. Camera flash cannot be used when the battery is running low.
- Clear the cache of the **Camera** app.

To clear an app's cache: go to the main menu, select **Settings > Apps > View all apps > Camera > Storage & cache**, select **Clear storage** and **Clear cache**.

- Drag down the quick settings bar in any interface, touch the flashlight icon to check whether the flash on your device works.
- Check whether the camera is set to the special shooting mode. In order to achieve a certain effect, the program will prohibit the use of the flash. Please revert to normal camera shooting mode.

## How to back up my device data

- Go to **Settings > System > Backup** (refer to “4.23 System > Backup”)

# 7 Specifications

## Platform:

- MediaTek Helio G100 Turbo

## OS:

- Android 16

## Memory<sup>(1)</sup>:

### T522E:

- ROM Memory: 256GB
- RAM Memory: 8GB

### T522E1:

- ROM Memory: 256GB
- RAM Memory: 4GB

## Dimensions (LxWxT):

- 167.69mm\*79.07mm\*8.99mm

## Weight:

- 215g

## Display:

- 6.8 inch Hole, 120Hz

## Network:

- GSM: 850/900/1800/1900
- 3G: B1/2/4/5/8
- 4G: B1/2/3/4/5/7/8/12/13/17/20/26/28/38/40/66/41 (2496-2690MHz)

## Connectivity:

- Bluetooth 6.0

<sup>(1)</sup> Depending on the device you purchased.

- 802.11a/ b/g/n/ac, 2.4GHz & 5Ghz
- Type C 2.0 Cable

**Camera:**

- Rear Camera: 50MP (Main&Macro) + 0.08MP Dual
- Front camera: 8MP

**Battery <sup>(1)</sup>:**

- Capacity: 6500mAh

**Sensors:**

- Accelerometer (G sensor)
- Proximity Sensor
- Light Sensor
- Fingerprint

**Note:** Specifications are subject to change without prior notice.

<sup>(1)</sup> The original battery has undergone rigorous safety inspections to meet qualification standards, the use of non-original batteries may be dangerous.

## 8 ECO design technical information

**Cobalt in the battery:**

- $10 \geq x \geq 2$ g

**Tantalum in capacitors:**

- $x < 0.01$  g

**Neodymium in loud speakers, vibration motors, and other magnets:**

- $x > 0.2$  g

**Gold in all components:**

- $x < 0.02$  g

**Recyclability rate  $R_{cyc}$ :**

- 82.1%

**The indicative percentage of recycled content for the product or a part thereof:**

- not known

**Ingress protection rating:**

- IP64

**Minimum battery endurance in cycles in number of cycles:**

- 1000

## 9 Accessories

Standard accessories (Plastic free packaging)

- TypeC 2.0 Cable
- SIM Card PIN
- Quick Start Guide
- LCD Sticker



- Accessories may vary by countries and operators.
- Only use the TCL batteries, and accessories included along with your device.

## 10 Licences



Bluetooth SIG, Inc. licensed and certificated TCL T522E/T522E1  
Bluetooth Design Number Q376930

---



Wi-Fi Alliance certificated

---

## 11 Disclaimer

This document is for reference only. The actual product (including but not limited to color, size, screen layout, etc.) may differ from the description depending on the region, service provider, or software version. This document is subject to changes without prior notice. Please refer to the actual product for accurate details. All statements, information and recommendations in this document do not constitute any form of warranty, whether express or implied.

**INSPIRE GREATNESS**