

SFP-25GB-CW-53-10-AO

MSA and TAA 25GBase-CWDM SFP28 Transceiver (SMF, 1530nm, 10km, LC, DOM)

Features

- Up to 25.78Gbps bi-directional data links
- Built-in dual CDR with bypass function
- Electrical interface specifications per SFF-8431
- CWDM-rated EML Transmitter and APD Receiver
- Up to 10km on 9/125um SMF
- SFP28 MSA package with duplex LC connector
- Operating temperature: 0 to 70 Celsius
- Single +3.3V power supply
- 1.8W maximum power consumption
- SFF-8432 and SFF-8472 Compliance
- Class 1 Laser Safety Certified
- RoHS compliant and lead-free



Applications

- 25x Gigabit Ethernet over CWDM
- Access, Metro and Enterprise
- Mobile Fronthaul CPRI/OBSAI

Product Description

This MSA Compliant SFP28 transceiver provides 25GBase-CWDM throughput up to 10km over single-mode fiber (SMF) using a wavelength of 1530nm via an LC connector. It is built to MSA standards and is uniquely serialized and data-traffic and application tested to ensure that they will integrate into your network seamlessly. Digital optical monitoring (DOM) support is also present to allow access to real-time operating parameters. This transceiver is Trade Agreements Act (TAA) compliant. We stand behind the quality of our products and proudly offer a limited lifetime warranty.

AddOn's transceivers are RoHS compliant and lead-free.

TAA refers to the Trade Agreements Act (19 U.S.C. & 2501-2581), which is intended to foster fair and open international trade. TAA requires that the U.S. Government may acquire only "U.S. – made or designated country end products."



Regulatory Compliance

- ESD to the Electrical PINs: compatible with MIL-STD-883E Method 3015.4.
- ESD to the LC Receptacle: compatible with IEC 61000-4-3.
- EMI/EMC: compatible with FCC Part 15 Subpart B Rules, EN55022:2010.
- Laser Eye Safety: compatible with FDA 21CFR, EN60950-1& EN (IEC) 60825-1, 2.
- RoHS: compliant with EU RoHS 2.0 directive 2015/863/EU.

CWDM Available Wavelengths

Wavelengths	Min.	Typ.	Max.
47	1464.5	1471	1477.5
49	1484.5	1491	1497.5
51	1504.5	1511	1517.5
53	1524.5	1531	1537.5
55	1544.5	1551	1557.5

Absolute Maximum Ratings

Parameter	Symbol	Min.	Typ.	Max.	Unit	Notes
Maximum Supply Voltage	Vcc	-0.5		4.0	V	
Storage Temperature	Tstg	-40		85	°C	
Operating Case Temperature	Tc	0	25	70	°C	
Relative Humidity	RH	5		95	%	
Data Rate			24.33 25.78		Gbps	
Bit Error Rate	BER			5×10^{-5}		1
Supported Link Length on 9/125µm SMF @ 25.78Gbps	L		10		km	2

Notes:

1. Tested with a PRBS 2³¹-1 test pattern for 25.78Gbps operation.
2. Distances are based on FC-PI-6 Rev. 3.1 and IEEE 802.3 standards.

Electrical Characteristics

Parameter		Symbol	Min.	Typ.	Max.	Unit	Notes
Power Supply Voltage		V _{CC}	3.135	3.3	3.465	V	
Power Supply Current		I _{CC}			545	mA	
Power Dissipation		P _D			1800	mW	
Transmitter							
Differential Input Impedance		Z _{IN}		100		Ω	
Differential Data Input Swing		V _{IN,pp}	180		700	mVp-p	
Tx_Fault	Transmitter Fault	V _{OH}	2.0		Host_Vcc	V	
	Normal Operation	V _{OL}	0		0.8	V	
Tx_Disable	Transmitter Disable	V _{IH}	2.0		Host_Vcc	V	
	Transmitter Enable	V _{IL}	0		0.8	V	
Receiver							
Differential Output Impedance		Z _{OUT}		100		Ω	
Differential Data Output Swing		V _{OUT,pp}	300		850	mVp-p	1
Data Output Rise Time/Fall Time		T _r /T _f	15			ps	2
Rx_LOS	Loss of Signal (LOS)	V _{OH}	2.0		Host_Vcc	V	3
	Normal Operation	V _{OL}	0		0.8	V	3

Notes:

1. Internally AC coupled but requires an external 100Ω differential load termination.
2. 20–80 %.
3. LOS is an open collector output. Should be pulled up with 4.7kΩ on the host board.

Optical Characteristics

Parameter	Symbol	Min.	Typ.	Max.	Unit	Notes
Transmitter						
Launch Optical Power	P _o	0		5	dBm	1
Extinction Ratio	ER	4.5			dB	
Center Wavelength Range	λ _C	1464.5		1557.5	nm	
Transmitter and Dispersion Penalty	TDP			4	dB	
Spectral Width	Δλ			1	nm	2
Optical Return Loss Tolerance	ORLT			21	dB	
Pout @Tx_Disable Asserted	P _{off}			-30	dBm	
Receiver						
Center Wavelength	λ _C	1460		1620	nm	
Receiver Sensitivity (Avg)	S			-19	dBm	1
Receiver Overload	P _{max}	-4			dBm	
Optical Return Loss	ORL	26			dB	
LOS De-Assert	LOSD			-19	dBm	
LOS Assert	LOSA	-35			dBm	
LOS Hysteresis		0.5			dB	

Notes:

1. Class 1 Laser Safety per FDA/CDRH and EN (IEC) 60825 regulations.
2. 20dB spectral width.
3. Measured with PRBS 2³¹-1 at 5×10⁻⁵ BER.

Pin Descriptions

Pin	Symbol	Name/Descriptions	Ref.
1	VeeT	Transmitter Ground (Common with Receiver Ground).	1
2	Tx_Fault	Transmitter Fault. LVTTTL-O.	2
3	Tx_Disable	Transmitter Disable. Laser output disabled on “high” or “open.” LVTTTL-I.	3
4	SDA	2-Wire Serial Interface Data. Same as MOD-DEF2 in INF-8074i. LVTTTL-I/O.	
5	SCL	2-Wire Serial Interface Data. Same as MOD-DEF2 in INF-8074i. LVTTTL-I.	
6	MOD_ABS	Module Absent. Connect to VeeT or VeeR in the module.	4
7	RS0	Rate Select 0. Not used.	5
8	LOS	Loss of Signal Indication. Logic 0 indicates normal operation. LVTTTL-O.	2
9	RS1	Rate Select 1. Not used.	5
10	VeeR	Receiver Ground (Common with Transmitter Ground).	1
11	VeeR	Receiver Ground (Common with Transmitter Ground).	1
12	RD-	Receiver Inverted Data Out. AC Coupled. CML-O.	
13	RD+	Receiver Non-Inverted Data Out. AC Coupled. CML-O.	
14	VeeR	Receiver Ground (Common with Transmitter Ground).	1
15	VccR	Receiver Power Supply.	
16	VccT	Transmitter Power Supply.	
17	VeeT	Transmitter Ground (Common with Receiver Ground).	1
18	TD+	Transmitter Non-Inverted Data In. AC Coupled. CML-I.	
19	TD-	Transmitter Inverted Data In. AC Coupled. CML-O.	
20	VeeT	Transmitter Ground (Common with Receiver Ground).	1

Notes:

1. The module signal ground contacts, VeeR and VeeT, should be isolated from the module case.
2. This contact is an open collector/drain output and should be pulled up to the Host_Vcc with the resistor in the range 4.7kΩ-10kΩ. Pull-ups can be connected to one or several power supplies; however, the host board design shall ensure that no module contract has voltage exceeding module VccT/R+0.5V.
3. Tx_Disable is an input contact with a 4.7kΩ-10kΩ pull-up resistor to the VccT inside the module.
4. MOD_ABS is connected to the VeeT or VeeR in the SFP+ module. The host may pull the contract up to Host_Vcc with a resistor in the range from 4.7kΩ-10kΩ. MOD_ABS is asserted “high” when the SFP+ module is physically absent from a host slot.
5. Internally pulled down per SFF-8431.



Pin-Out of Connector Block on the Host Board

Recommended Host Board Power Supply Filter Network



Recommended Application Interface Block Diagram

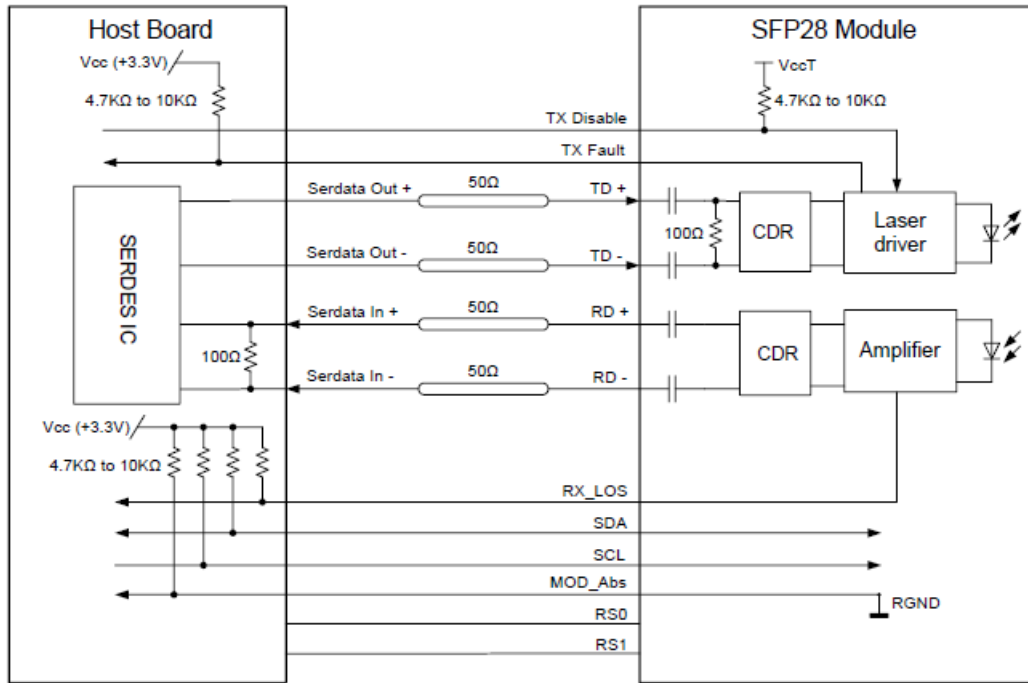

Mechanical Specifications



About AddOn Networks

In 1999, AddOn Networks entered the market with a single product. Our founders fulfilled a severe shortage for compatible, cost-effective optical transceivers that compete at the same performance levels as leading OEM manufacturers. Adhering to the idea of redefining service and product quality not previously had in the fiber optic networking industry, AddOn invested resources in solution design, production, fulfillment, and global support.

Combining one of the most extensive and stringent testing processes in the industry, an exceptional free tech support center, and a consistent roll-out of innovative technologies, AddOn has continually set industry standards of quality and reliability throughout its history.

Reliability is the cornerstone of any optical fiber network and is engrained in AddOn's DNA. It has played a key role in nurturing the long-term relationships developed over the years with customers. AddOn remains committed to exceeding industry standards with certifications from ranging from NEBS Level 3 to ISO 9001:2005 with every new development while maintaining the signature reliability of its products.

U.S. Headquarters

Email: sales@addonnetworks.com

Telephone: +1 877.292.1701

Fax: 949.266.9273

Europe Headquarters

Email: salesupportemea@addonnetworks.com

Telephone: +44 1285 842070