

Latitude 5540

Owner's Manual

Notes, cautions, and warnings

 **NOTE:** A NOTE indicates important information that helps you make better use of your product.

 **CAUTION:** A CAUTION indicates either potential damage to hardware or loss of data and tells you how to avoid the problem.

 **WARNING:** A WARNING indicates a potential for property damage, personal injury, or death.

Chapter 1: Views of Latitude 5540.....	8
Right.....	8
Left.....	9
Top.....	10
Front.....	11
Back.....	12
Bottom.....	12
Service Tag.....	13
Battery-charge status light.....	13
Chapter 2: Set up your Latitude 5540.....	14
Chapter 3: Specifications of Latitude 5540.....	16
Dimensions and weight.....	16
Processor.....	16
Chipset.....	18
Operating system.....	18
Memory.....	18
External ports and slots.....	19
Internal slots.....	19
Ethernet.....	20
Wireless module.....	20
WWAN module.....	21
Audio.....	22
Storage.....	22
Media-card reader	23
Keyboard.....	23
Keyboard function keys.....	24
Camera.....	25
Touchpad.....	25
Power adapter.....	26
Battery.....	28
Display.....	29
Fingerprint reader (optional).....	30
Sensor	30
GPU—Integrated.....	30
GPU—Discrete.....	30
External display support.....	31
Hardware security.....	31
Smart-card reader.....	31
Contactless smart-card reader.....	31
Contacted smart-card reader.....	33
Operating and storage environment.....	34
Dell support policy.....	34

ComfortView Plus.....	34
Using the privacy shutter.....	34
Dell Optimizer.....	35
Chapter 4: Working inside your computer.....	36
Safety instructions.....	36
Before working inside your computer.....	36
Safety precautions.....	37
Electrostatic discharge—ESD protection.....	37
ESD Field Service kit	38
Transporting sensitive components.....	39
After working inside your computer.....	39
BitLocker.....	39
Recommended tools.....	39
Screw list.....	40
Major components of Latitude 5540.....	41
Chapter 5: Removing and installing Customer Replaceable Units (CRUs).....	44
SIM card tray (optional)	44
Removing the SIM card tray.....	44
Installing the SIM card tray.....	45
SIM card.....	45
Removing the SIM card.....	45
Installing the SIM card.....	46
Base cover.....	47
Removing the base cover.....	47
Installing the base cover.....	50
Wireless card.....	52
Removing the WLAN card.....	52
Installing the WLAN card.....	53
WWAN card (Optional).....	54
Removing the 4G WWAN card (Optional).....	54
Installing the 4G WWAN card (Optional).....	55
Removing the 5G WWAN card (Optional).....	57
Installing the 5G WWAN card (Optional).....	58
Memory module.....	60
Removing the memory module.....	60
Installing the memory module.....	61
Solid-state drive.....	61
Removing the M.2 2230 solid-state drive from Slot 1.....	61
Installing the M.2 2230 solid-state drive in Slot 1.....	63
Removing the M.2 2280 solid-state drive from Slot 1.....	64
Installing the M.2 2280 solid-state drive in Slot 1.....	65
Removing the M.2 2230 solid-state drive from Slot 2.....	66
Installing the M.2 2230 solid-state drive in Slot 2.....	67
Fan.....	68
Removing the fan.....	68
Installing the fan.....	69

Chapter 6: Removing and installing Field Replaceable Units (FRUs)	71
Battery.....	71
Rechargeable Li-ion battery precautions.....	71
Removing the battery.....	71
Installing the battery.....	73
Assembly-inner frame.....	75
Removing the assembly-inner frame.....	75
Installing the assembly-inner frame.....	76
Speakers.....	78
Removing the speakers.....	78
Installing the speakers.....	79
Coin-cell battery.....	80
Removing the coin-cell battery.....	80
Installing the coin-cell battery.....	81
Heat sink.....	82
Removing the heat sink (Discrete GPU).....	82
Installing the heat sink (Discrete GPU).....	83
Removing the heat sink (Integrated GPU).....	84
Installing the heat sink (Integrated GPU).....	85
System board.....	86
Removing the system board.....	86
Installing the system board.....	90
Power button.....	93
Removing the power button.....	93
Installing the power button.....	94
Power button with optional fingerprint reader.....	95
Removing the power button with optional fingerprint reader.....	95
Installing the power button with optional fingerprint reader.....	96
Keyboard.....	97
Removing the keyboard.....	97
Installing the keyboard.....	99
Display assembly.....	101
Removing the display assembly.....	101
Installing the display assembly.....	104
Display bezel.....	107
Removing the display bezel.....	107
Installing the display bezel.....	108
Display panel.....	109
Removing the display panel.....	109
Installing the display panel.....	111
Camera module.....	115
Removing the camera module.....	115
Installing the camera module.....	116
Display hinges.....	118
Removing the display hinges.....	118
Installing the display hinges.....	118
Display back cover.....	119
Removing the display back cover.....	119
Installing the display back cover.....	120

Display cable.....	121
Removing the display cable.....	121
Installing the display cable.....	122
Sensor board.....	123
Removing the sensor board.....	123
Installing the sensor board.....	124
Fingerprint reader (optional).....	125
Removing the fingerprint reader (Optional).....	125
Installing the fingerprint reader (Optional).....	126
Smart-card reader.....	128
Removing the smart-card reader.....	128
Installing the smart-card reader.....	128
Dummy SIM-card slot filler.....	129
Removing the dummy SIM-card slot filler.....	129
Installing the dummy SIM-card slot filler.....	130
Palm-rest assembly.....	131
Removing the palm-rest assembly.....	131
Installing the palm-rest assembly.....	133
Chapter 7: Software.....	135
Operating system.....	135
Drivers and downloads.....	135
Chapter 8: BIOS Setup.....	136
Entering BIOS Setup program.....	136
Navigation keys.....	136
F12 One Time Boot menu.....	136
System setup options.....	137
Updating the BIOS.....	148
Updating the BIOS in Windows.....	148
Updating the BIOS in Linux and Ubuntu.....	148
Updating the BIOS using the USB drive in Windows.....	148
Updating the BIOS from the One-Time boot menu.....	149
System and setup password.....	149
Assigning a System Setup password.....	150
Deleting or changing an existing system password or setup password.....	150
Clearing CMOS settings.....	151
Clearing BIOS (System Setup) and System passwords.....	151
Chapter 9: Troubleshooting.....	152
Handling swollen rechargeable Li-ion batteries.....	152
Locating the Service Tag or Express Service Code of your Dell computer	152
Dell SupportAssist Pre-boot System Performance Check diagnostics.....	153
Running the SupportAssist Pre-Boot System Performance Check.....	153
Built-in self-test (BIST).....	153
M-BIST.....	153
LCD Power rail test (L-BIST).....	154
LCD Built-in Self-Test (BIST).....	154
System-diagnostic lights.....	155

Recovering the operating system.....	156
Real-Time Clock (RTC Reset).....	156
Backup media and recovery options.....	156
Wi-Fi power cycle.....	156
Drain residual flea power (perform hard reset).....	156

Chapter 10: Getting help and contacting Dell..... 158

Views of Latitude 5540

Right

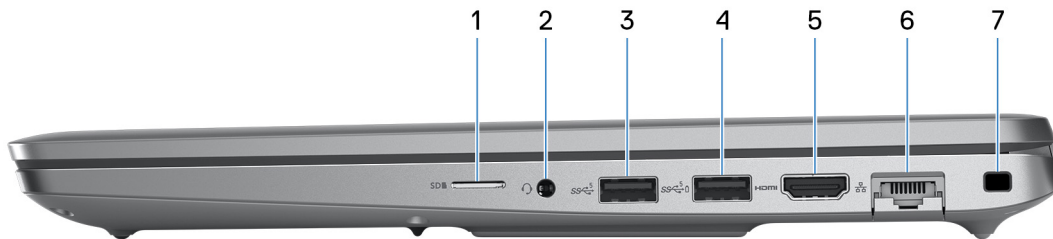

1. microSD-card slot

Reads from and writes to the microSD-card.

2. Universal audio jack

Connect headphones or a headset (headphone and microphone combo).

3. USB 3.2 Gen 1 port

Connect devices such as external storage devices and printers. Provides data transfer speeds up to 5 Gbps.

4. USB 3.2 Gen 1 port with PowerShare

Connect devices such as external storage devices and printers.

Provides data transfer speeds up to 5 Gbps. PowerShare enables you to charge your USB devices even when your computer is turned off.

i NOTE: If the charge on your computer's battery is less than 10 percent, you must connect the power adapter to charge your computer, and USB devices connected to the PowerShare port.

i NOTE: If your computer is turned off or in a hibernate state, you must connect the power adapter to charge your devices using the PowerShare port. You must enable this feature in the BIOS setup program.

i NOTE: Certain USB devices may not charge when the computer is turned off or in sleep state. In such cases, turn on the computer to charge the device.

5. HDMI 2.0 port

Connect to a TV, external display or another HDMI-in enabled device. Provides video and audio output.

6. Network port

Connect an Ethernet (RJ-45) cable from a router or a broadband modem for network or Internet access, with a transfer rate of 10/100/1000 Mbps.

7. Security-cable slot (wedge-shaped)

Connect a security cable to prevent unauthorized movement of your computer.

Left



1. Thunderbolt 4.0 port with Power Delivery and DisplayPort

Supports USB4, DisplayPort 1.4, Thunderbolt 4 and also enables you to connect to an external display using a display adapter. Supports data transfer rates of up to 40 Gbps for USB4 and Thunderbolt 4.

NOTE: You can connect a Dell Docking Station to the Thunderbolt 4 ports. For more information, search in the Knowledge Base Resource at [Dell Support Site](#).

NOTE: A USB Type-C to DisplayPort adapter (sold separately) is required to connect a DisplayPort device.

NOTE: USB4 is backward compatible with USB 3.2, USB 2.0, and Thunderbolt 3.

NOTE: Thunderbolt 4 supports two 4K displays or one 8K display.

2. Thunderbolt 4.0 port with Power Delivery and DisplayPort

Supports USB4, DisplayPort 1.4, Thunderbolt 4 and also enables you to connect to an external display using a display adapter. Supports data transfer rates of up to 40 Gbps for USB4 and Thunderbolt 4.

NOTE: You can connect a Dell Docking Station to the Thunderbolt 4 ports. For more information, search in the Knowledge Base Resource at [Dell Support Site](#).

NOTE: A USB Type-C to DisplayPort adapter (sold separately) is required to connect a DisplayPort device.

NOTE: USB4 is backward compatible with USB 3.2, USB 2.0, and Thunderbolt 3.

NOTE: Thunderbolt 4 supports two 4K displays or one 8K display.

3. Battery-status light

Indicates the battery-charge status.

Solid yellow—Battery charge is low.

Blinking yellow—Battery charge is critical.

4. Smart-card reader slot (optional)

Top

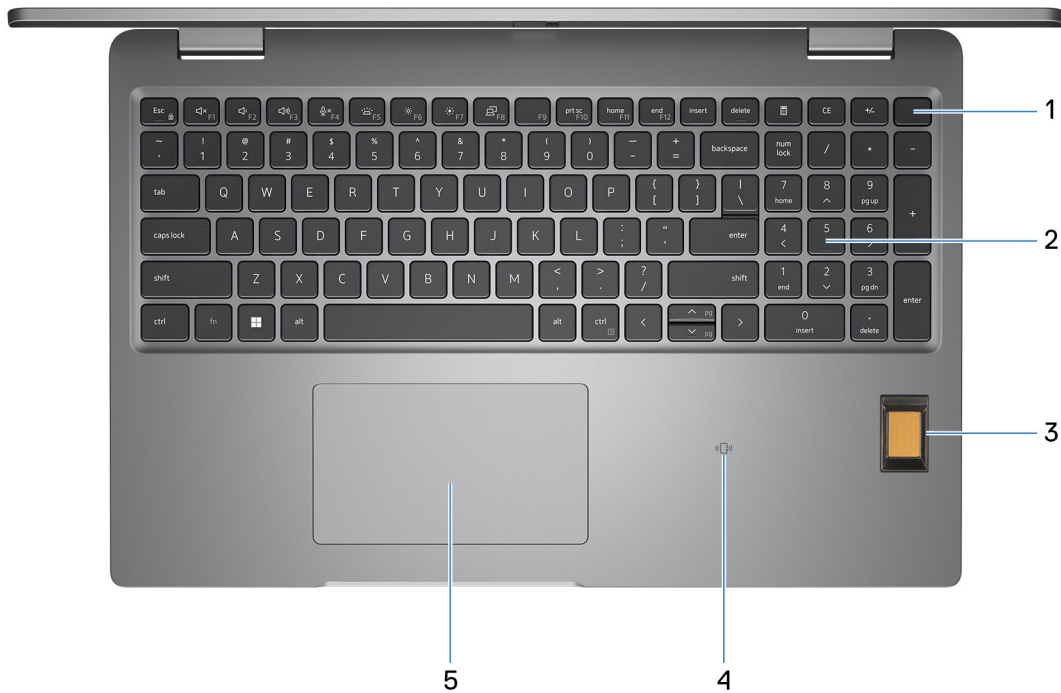

1. Power button with optional fingerprint reader

Press to turn on the computer if it is turned off, in sleep state, or in hibernate state.

When the computer is turned on, press the power button to put the computer into sleep state; press and hold the power button for 10 seconds to force shut-down the computer.

If the power button has a fingerprint reader, place your finger on the power button steadily to log in.

NOTE: The power-status light on the power button is available only on computers without the fingerprint reader. Computers that are shipped with the fingerprint reader that is integrated on the power button will not have the power-status light on the power button.

NOTE: The power-button behavior can be customized in the operating system.

2. Keyboard

3. Fingerprint reader (optional)

Press your finger on the fingerprint reader to log in to your computer. The fingerprint reader enables your computer to recognize your fingerprints as a password.

NOTE: Configure the fingerprint reader to register your fingerprint and enable access.

4. NFC/Contactless smart card reader (optional)

5. Touchpad

Move your finger on the touchpad to move the mouse pointer. Tap to left-click and two fingers tap to right-click.

1. Touchpad

Move your finger on the touchpad to move the mouse pointer. Tap to left-click and two fingers tap to right-click.

2. Left-click area

Press to left-click.

3. Right-click area

Press to right-click.

4. Power button

Press to turn on the computer if it is turned off, in sleep state, or in hibernate state.

When the computer is turned on, press the power button to put the computer into sleep state; press and hold the power button for 10 seconds to force shut-down the computer.

NOTE: You can customize the power-button behavior in Windows. For more information, see *Me and My Dell* at [Dell Support Mannuals](#).

Front



1. Left microphone

Provides digital sound input for audio recording and voice calls.

2. Infrared emitter (optional)

Emits infrared light, which enables the infrared camera to sense and track motion.

3. Infrared camera (optional)

Enhances security when paired with Windows Hello face authentication.

4. Camera shutter

Slide the privacy shutter to the left to access the camera lens.

5. Camera

Make video calls, capture photos, or record videos.

6. Camera-status light

Turns on when the camera is in use.

7. Ambient-light sensor

The sensor detects the ambient light and automatically adjusts the display brightness.

8. Right microphone

Provides digital sound input for audio recording and voice calls.

Back



1. Nano-SIM card slot (optional)

Insert a nano-SIM card to connect to a mobile broadband network.

NOTE: Availability of the nano-SIM card slot depends on the region and configuration ordered.

Bottom

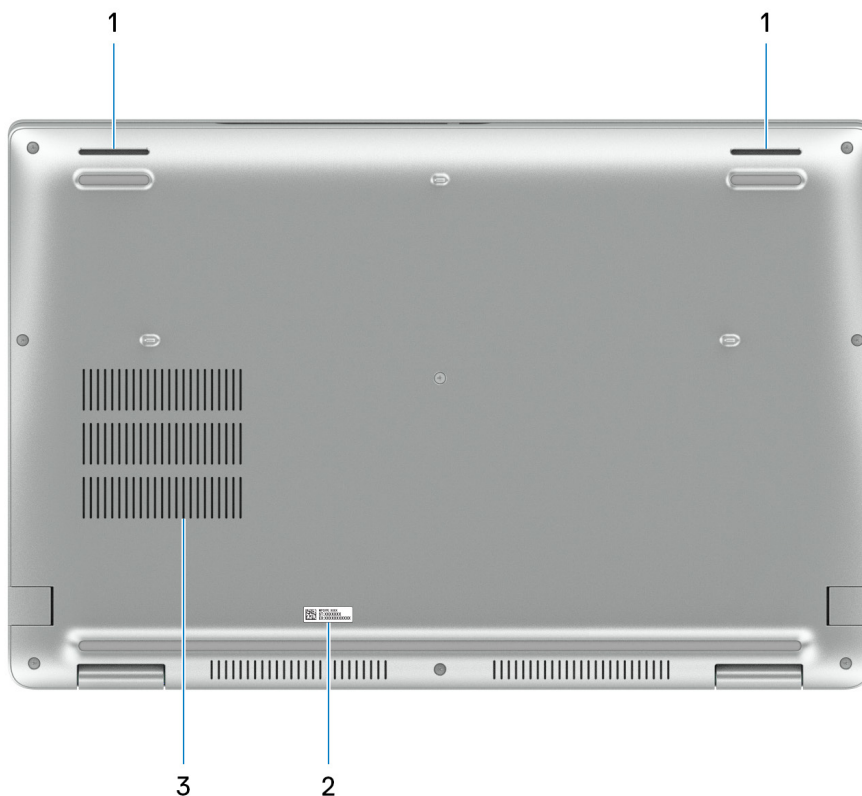

1. Speakers

Provide audio output.

2. Service Tag label

The Service Tag is a unique alphanumeric identifier that enables Dell service technicians to identify the hardware components in your computer and access warranty information.

3. Fan vents

Service Tag

The service tag is a unique alphanumeric identifier that allows Dell service technicians to identify the hardware components in your computer and access warranty information.

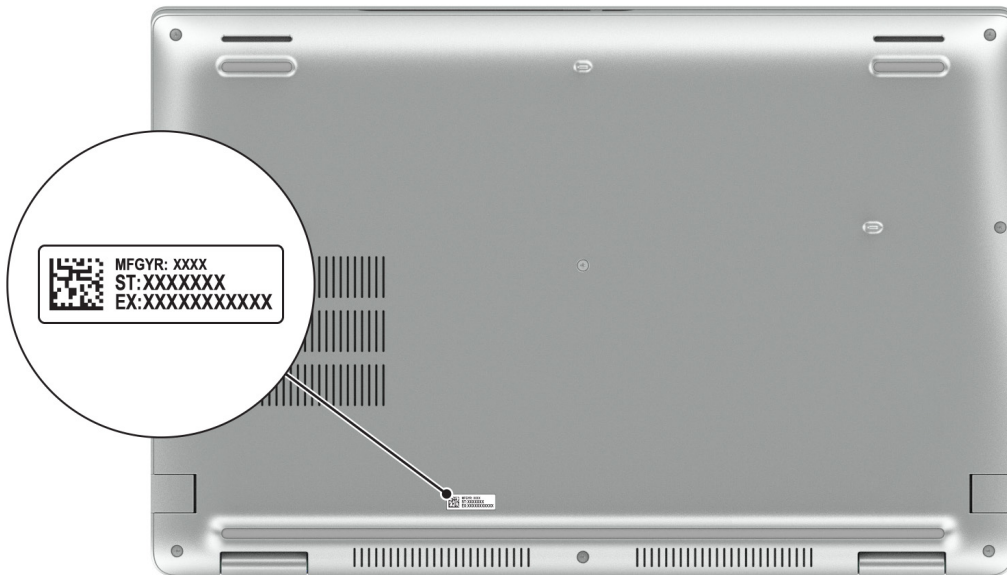

Battery-charge status light

The following table lists the battery-charge status light of your Latitude 5540.

Table 1. Battery charge and status light behavior

Power source	LED behavior	System power state	Battery charge level
AC adapter	Off	S0 or S5	Fully charged
AC adapter	Solid white	S0 or S5	< Fully charged
Battery	Off	S0 or S5	11-100%
Battery	Solid amber (590+/-3 nm)	S0 or S5	< 10%

- S0 (ON): Computer is turned on.
- S4 (Hibernate): The computer consumes the least power in the Hibernate state than in the ON or OFF state. The computer is almost in the OFF state. The context data is written to a storage device, allowing you to resume from where you left when the computer is turned on.
- S5 (OFF): The computer is in a shutdown state.

Set up your Latitude 5540

About this task

NOTE: The images in this document may differ from your computer depending on the configuration you ordered.

Steps

1. Connect the power adapter and press the power button.



NOTE: To conserve battery power, the battery might enter power saving mode. Connect the power adapter and press the power button to turn on the computer.

2. Finish operating system setup.

For Ubuntu:

Follow the on-screen instructions to complete the setup. For more information about installing and configuring Ubuntu, search in the Knowledge Base Resource at [Dell Support Site](#).

For Windows:

Follow the on-screen instructions to complete the setup. When setting up, Dell Technologies recommends that you:





- Connect to a network for Windows updates.

NOTE: If connecting to a secured wireless network, enter the password for the wireless network access when prompted.

- If connected to the Internet, sign-in with or create a Microsoft account. If not connected to the Internet, create an offline account.
- On the **Support and Protection** screen, enter your contact details.

3. Locate and use Dell apps from the Windows Start menu—Recommended.

Table 2. Locate Dell apps

Resources	Description
	<p>Dell Product Registration Register your computer with Dell.</p>
	<p>Dell Help & Support Access help and support for your computer.</p>
	<p>SupportAssist SupportAssist is the smart technology that keeps your computer running at its best by optimizing settings, detecting issues, removing viruses and notifies when you need to make system updates. SupportAssist proactively checks the health of your system's hardware and software. When an issue is detected, the necessary system state information is sent to Dell to begin troubleshooting. SupportAssist is preinstalled on most of the Dell devices running Windows operating system. For more information, see SupportAssist for Home PCs User's Guide on Serviceability Tools at the Dell Support Site.</p> <p>NOTE: In SupportAssist, click the warranty expiry date to renew or upgrade your warranty.</p>
	<p>Dell Update Updates your computer with critical fixes and latest device drivers as they become available. For more information about using Dell Update, search in the Knowledge Base Resource at Dell Support Site.</p>
	<p>Dell Digital Delivery Download software applications, which are purchased but not preinstalled on your computer. For more information about using Dell Digital Delivery, search in the Knowledge Base Resource at Dell Support Site.</p>

Specifications of Latitude 5540

Dimensions and weight

The following table lists the height, width, depth, and weight of your Latitude 5540.

Table 3. Dimensions and weight

Description	Values
Height:	
Front height	20.80 mm (0.82 in.)
Rear height	22.80 mm (0.90 in.)
Width	357.80 mm (14.09 in.)
Depth	233.30 mm (9.19 in.)
Weight  NOTE: The weight of your computer depends on the configuration that is offered.	1.613 kg (3.56 lb)

Processor

The following table lists the details of the processors supported by your Latitude 5540.

Table 4. Processor

Description	Option one	Option two	Option three	Option four	Option five	Option six	Option seven	Option eight
Processor type	13 th Generation Intel Core i3-1315U	13 th Generation Intel Core i5-1335U	13 th Generation Intel Core i5-1345U vPro	13 th Generation Intel Core i5-1340P	13 th Generation Intel Core i5-1350P vPro	13 th Generation Intel Core i7-1355U	13 th Generation Intel Core i7-1365U vPro	13 th Generation Intel Core i7-1370P vPro
Processor wattage	15 W	15 W	15 W	28 W	28 W	15 W	15 W	28 W
Processor total core count	6	10	10	12	12	10	10	14
Performance-cores	2	2	2	4	4	2	2	6
Efficient-cores	4	8	8	8	8	8	8	8
Processor total thread counts	8	12	12	16	16	12	12	20
 NOTE: Intel® Hyper-Threading Technology is only available on Performance-cores.								
Processor speed	Up to 4.50 GHz	Up to 4.60 GHz	Up to 4.70 GHz	Up to 4.60 GHz	Up to 4.70 GHz	Up to 5 GHz	Up to 5.20 GHz	Up to 5.20 GHz
Performance-cores frequency								
Processor base frequency	1.20 GHz	1.30 GHz	1.60 GHz	1.90 GHz	1.90 GHz	1.70 GHz	1.80 GHz	1.90 GHz
Maximum turbo frequency	4.50 GHz	4.60 GHz	4.70 GHz	4.60 GHz	4.70 GHz	5 GHz	5.20 GHz	5.20 GHz
Efficient-cores frequency								
Processor base frequency	0.90 GHz	0.90 GHz	1.20 GHz	1.40 GHz	1.40 GHz	1.20 GHz	1.30 GHz	1.40 GHz
Maximum turbo frequency	3.30 GHz	3.40 GHz	3.50 GHz	3.40 GHz	3.50 GHz	3.70 GHz	3.90 GHz	3.90 GHz
Processor cache	10 MB	12 MB	12 MB	12 MB	12 MB	12 MB	12 MB	24 MB
Integrated graphics	Intel UHD Graphics	Intel Iris Xe ^e Graphics	Intel Iris Xe ^e Graphics	Intel Iris Xe ^e Graphics	Intel Iris Xe ^e Graphics	Intel Iris Xe ^e Graphics	Intel Iris Xe ^e Graphics	Intel Iris Xe ^e Graphics

Chipset

The following table lists the details of the chipset that is supported in your Latitude 5540.

Table 5. Chipset

Description	Values
Chipset	Integrated in the processor
Processor	13 th Generation Intel Core i3/i5/i7
DRAM bus width	64-bit
Flash EPROM	32 MB for non-vPro, 32 MB + 16 MB for vPro/vPro Essentials
PCIe bus	Up to Gen 4

Operating system

Your Latitude 5540 supports the following operating systems:

- Windows 11 Home, 64-bit
- Windows 11 Pro, 64-bit
- Windows 11 Pro downgrade (Win 10 Pro image FI + Win 11 Pro DPK)
- Ubuntu 22.04 LTS, 64-bit

Memory

The following table lists the memory specifications that are supported by your Latitude 5540.

Table 6. Memory specifications

Description	Values
Memory slots	Two-SODIMM slots
Memory type	<ul style="list-style-type: none">• Single-channel DDR4• Dual-channel DDR4• Single-channel DDR5• Dual-channel DDR5 <p>i NOTE: DDR4 memory is only supported on computers with 13th Generation Intel Core U-series processors.</p> <p>i NOTE: DDR5 memory is only supported on computers with 13th Generation Intel Core P-series processors.</p>
Memory speed	<ul style="list-style-type: none">• 3200 MT/s• 4800 MT/s• 5200 MT/s
Maximum memory configuration	64 GB
Minimum memory configuration	8 GB
Memory size per slot	8 GB, 16 GB, or 32 GB
Memory configurations supported	<ul style="list-style-type: none">• 8 GB, 1 x 8 GB, DDR4, 3200 MT/s, single-channel

Table 6. Memory specifications (continued)

Description	Values
	<ul style="list-style-type: none"> • 16 GB, 2 x 8 GB, DDR4, 3200 MT/s, dual-channel • 16 GB, 1 x 16 GB, DDR4, 3200 MT/s, single-channel • 32 GB, 2 x 16 GB, DDR4, 3200 MT/s, dual-channel • 64 GB, 2 x 32 GB, DDR4, 3200 MT/s, dual-channel • 8 GB, 1 x 8 GB, DDR5, 4800 MT/s, single-channel • 16 GB, 2 x 8 GB, DDR5, 4800 MT/s, dual-channel • 16 GB, 1 x 16 GB, DDR5, 4800 MT/s, single-channel • 32 GB, 2 x 16 GB, DDR5, 4800 MT/s, dual-channel • 64 GB, 2 x 32 GB, DDR5, 4800 MT/s, dual-channel • 8 GB, 1 x 8 GB, DDR5, 5200 MT/s, single-channel • 16 GB, 2 x 8 GB, DDR5, 5200 MT/s, dual-channel • 16 GB, 1 x 16 GB, DDR5, 5200 MT/s, single-channel • 32 GB, 2 x 16 GB, DDR5, 5200 MT/s, dual-channel • 64 GB, 2 x 32 GB, DDR5, 5200 MT/s, dual-channel

External ports and slots

The following table lists the external ports and slots of your Latitude 5540.

Table 7. External ports and slots

Description	Values
Network port	One RJ-45 port
USB ports	<ul style="list-style-type: none"> • Two Thunderbolt 4 port Power Delivery and DisplayPort <p>NOTE: You can connect a Dell Docking Station to this port. For more information, search in the Knowledge Base Resource at Dell Support site.</p> <ul style="list-style-type: none"> • One USB 3.2 Gen 1 port with PowerShare • One USB 3.2 Gen 1 port
Audio port	One Universal audio jack
Video port(s)	One HDMI 2.0 port
Media-card reader	One microSD-card slot
Power-adaptor port	USB Type-C power input
Security-cable slot	One security-cable slot (wedge-shaped)

Internal slots

The following table lists the internal slots of your Latitude 5540.

Table 8. Internal slots

Description	Values
M.2	<ul style="list-style-type: none"> • One M.2 2230 slot for WiFi and Bluetooth combo card • One M.2 2230/2280 slot for solid-state drive

Table 8. Internal slots

Description	Values
	<ul style="list-style-type: none"> One M.2 2230 slot for solid-state drive One M.2 3042/3052 for WWAN card <p>NOTE: To learn more about the features of different types of M.2 cards, search in the Knowledge Base Resource at Dell Support Site.</p>

Ethernet

The following table lists the wired Ethernet Local Area Network (LAN) specifications of your Latitude 5540.

Table 9. Ethernet specifications

Description	Values
Model	Intel I219-V/Intel I219-LM
Transfer rate	10/100/1000 Mbps

Wireless module

The following table lists the Wireless Local Area Network (WLAN) modules that are supported on your Latitude 5540.

Table 10. Wireless module specifications

Description	Option one	Option two
Model number	Realtek RTL8852BE	Intel AX211
Transfer rate	Up to 1201 Mbps	Up to 2400 Mbps
Frequency bands supported	2.4 GHz/5 GHz	2.4 GHz/5 GHz/6 GHz
Wireless standards	<ul style="list-style-type: none"> WiFi 802.11a/b/g Wi-Fi 4 (WiFi 802.11n) Wi-Fi 5 (WiFi 802.11ac) Wi-Fi 6 (WiFi 802.11ax) 	<ul style="list-style-type: none"> WiFi 802.11a/b/g Wi-Fi 4 (WiFi 802.11n) Wi-Fi 5 (WiFi 802.11ac) Wi-Fi 6E (WiFi 802.11ax) <p>NOTE: Wi-Fi 6 is supported in regions where Wi-Fi 6E is unavailable.</p>
Encryption	<ul style="list-style-type: none"> 64-bit/128-bit WEP AES-CCMP TKIP 	<ul style="list-style-type: none"> 64-bit/128-bit WEP AES-CCMP TKIP
Bluetooth wireless card	Bluetooth 5.3	Bluetooth 5.3
	<p>NOTE: The functionality of the Bluetooth wireless card may vary depending on the operating system that is installed on your computer.</p>	

WWAN module

The following table lists the Wireless Wide Area Network (WWAN) modules that are supported in your Latitude 5540.

- NOTE:** The WWAN module is available only on certain configurations and in certain regions.
- NOTE:** Availability of the eSIM feature on this module depends on your region.
- NOTE:** For instructions on how to setup SIM or eSIM connections on your computer, see the *SIM/eSIM Setup Guide for Windows* available with your product documentation at [Dell Support Site](#).

Table 11. WWAN module specifications

Description	Option one	Option two
Model number	DW5823, Intel XMM 7560 R Global LTE-Advanced, CAT16	DW5931e, Intel 5G 5000 Global Gigabit NR/LTE, 3GPP Release 15
Form factor	M.2 3042 Key-B	M.2 3052 Key-B
Host interface	PCIe Gen2	PCIe Gen3
Network standard	LTE FDD/TDD, WCDMA/HSPA+,GPS/GLONASS/BDS/Galileo	NR FR1(Sub6) FDD/TDD, LTE FDD/TDD, WCDMA/HSPA+, GPS/GLONASS/Galileo/BDS/QZSS
Transfer data rate	<ul style="list-style-type: none"> • Up to 1 Gbps DL (CAT16) • Up to 150 Mbps UL 	<ul style="list-style-type: none"> • SA: DL 4.67 Gbps/UL 1.25 Gbps • NSA: DL 3.74 Gbps/UL 835Mbps • LTE: DL 1.6 Gbps (CAT19)/UL 211Mbps (CAT18) • UMTS: DL 384 kbps/UL 384 kbps DL DC-HSPA+: 42 Mbps (CAT24)/UL 11.5 Mbps (CAT7)
Operating frequency bands	<ul style="list-style-type: none"> • LTE(B1, B2, B3, B4, B5, B7, B8, B12, B13, B14, B17, B18, B19, B20, B25, B26, B28, B29, B30, B32, B34, B38, B39, B40, B41(HPUE), B42, B43, B46(receiver only), B48, B66, B71 • WCDMA/HSPA+(1, 2, 4, 5, 8) 	<ul style="list-style-type: none"> • NR(n1, n2, n3, n5, n7, n8, n20, n25, n28, n30, n38, n40, n41, n48, n66, n71, n77, n78, n79) • LTE (B1, B2, B3, B4, B5, B7, B8, B12, B13, B14, B17, B18, B19, B20, B25, B26, B28, B29, B30, B32, B34, B38, B39, B40, B41, B42, B43, B46, B48, B66, B71*) • WCDMA/HSPA+ (1, 2, 4, 5, 8)
Power supply	DC 3.135 V to 4.40 V, typical 3.30 V	DC 3.135 V to 4.4 V, Typical 3.3 V
SIM card	Supported through external SIM slot	Supported through external SIM slot
eSIM with dual SIM (DSSA)	Supported (the availability of eSIM functionality embedded on the module is dependent on the region and specific carrier requirements)	Supported
Antenna diversity	Supported	Supported
Radio on/off	Supported	Supported
Wake on wireless	Supported	Supported

Table 11. WWAN module specifications (continued)

Description	Option one	Option two
Temperature	<ul style="list-style-type: none"> Normal operating temperature: -10°C to + 55°C Extended Operating temperature: -20°C to +65°C 	<ul style="list-style-type: none"> Normal operating temperature: -10°C to + 55°C Extended Operating temperature: -30°C to +75°C Storage temperature: -40°C to +85°C
Antenna connector	<ul style="list-style-type: none"> WWAN Main Antenna x 4 Supports 4x4 MIMO 	<ul style="list-style-type: none"> WWAN Main Antenna x 4 Supports 4x4 MIMO
<p>NOTE: For instructions to find your computer's International Mobile Equipment Identity (IMEI) number, search in the Knowledge Base Resource at Dell Support Site.</p>		

Audio

The following table lists the audio specifications of your Latitude 5540.

Table 12. Audio specifications

Description	Values	
Audio controller	Realtek Waves, MaxxAudio 12.0	
Stereo conversion	Supported	
Internal audio interface	High definition audio interface	
External audio interface	Universal Audio Jack/HDMI 2.0 port	
Number of speakers	2	
Internal-speaker amplifier	Not supported	
External volume controls	Keyboard shortcut controls	
Speaker output:		
	Average	2 W
	Peak	2 W
Microphone	Digital-array microphones in camera assembly	

Storage

This section lists the storage options on your Latitude 5540.

Your Latitude 5540 supports one of the following options

- One M.2 2230/2280 solid-state drive or optional dual storage

NOTE: SSD Slot 1 on the system board supports M.2 2230 or M.2 2280 solid-state drives.

NOTE: SSD Slot 2 on the system board only supports Gen3 M.2 2230 solid-state drive.

- One M.2 2230 self-encrypting drive

Table 13. Storage specifications

Storage type	Interface type	Capacity
M.2 2230 solid-state drive	<ul style="list-style-type: none"> • PCIe Gen3 x4 NVMe, up to 64 Gbps • PCIe Gen4 x4 NVMe, up to 64 Gbps 	Up to 2 TB
M.2 2280 solid-state drive	PCIe Gen4 x4 NVMe, up to 64 Gbps	Up to 1 TB

Media-card reader

The following table lists the media-card reader specifications of your Latitude 5540.

Table 14. Media-card reader (standard offering)

Media supported (Maximum capacity supported will vary by Flash Media Types)	
Media Supported	Micro Secure Digital (mSD) Micro Secure Digital High Capacity (mSDHC) Micro Secure Digital Extended Capacity (mSDXC)
Support Specification Versions	microSD 4.0 card

Keyboard

The following table lists the keyboard specifications of your Latitude 5540.

Table 15. Keyboard specifications

Description	Values
Keyboard type	<ul style="list-style-type: none"> • Standard backlit keyboard • Standard non-backlit keyboard
Keyboard layout	QWERTY
Number of keys	<ul style="list-style-type: none"> • English US, English International, Arabic, Canada bilingual (MUI), Chinese traditional, French-Canadian, Greek, Hebrew, Korean, Russian, Thai, Ukrainian: 99 keys • French-Canadian Quebec, Brazilian, Belgian, Bulgarian, Czech & Slovakian (MUI), Danish, English UK, Estonian, French European, German, Hungarian, Italian, Nordic (MUI), Norwegian, Portugese Iberian, Slovenian, Spanish (Castillian), Spanish (Latin America), Swedish/Finnish, Swiss European (MUI), Turkish, Turkish F: 100 keys • Japanese: 103 keys
Keyboard size	X= 18.05 mm key pitch Y= 18.05 mm key pitch
Keyboard shortcuts	<p>Some keys on your keyboard have two symbols on them. These keys can be used to type alternate characters or to perform secondary functions. To type the alternate character, press Shift and the desired key. To perform secondary functions, press Fn and the desired key.</p> <p>NOTE: You can define the primary behavior of the function keys (F1–F12) changing Function Key Behavior in the BIOS setup program.</p>

Table 15. Keyboard specifications (continued)

Description	Values
	<p> NOTE: If Copilot in Windows is not available on your computer, pressing the Copilot key launches Windows search. For more information about Copilot in Windows, search in the Knowledge Base Resource at the Dell Support site.</p>

Keyboard function keys

The **F1-F12** keys at the top of the keyboard are function keys. By default, these keys are used to perform specific functions defined by the software application in use.

You can run the secondary tasks that are indicated by the symbols on the function keys by pressing the function key with **fn**, for example, **fn** and **F1**. See the table below for the list of secondary tasks and the key combinations to run them.

 **NOTE:** Keyboard characters may differ depending on the keyboard language configuration. Keys that are used for tasks remain the same, regardless of the keyboard language.

 **NOTE:** You can define the primary behavior of function keys in the **Function Key Behavior** menu of the BIOS setup program.

Table 16. Secondary tasks of keyboard keys

Key combination for task	What the task does
fn and F1	Operating system and application specific F1 behavior
fn and F2	Operating system and application specific F2 behavior
fn and F3	Operating system and application specific F3 behavior
fn and F4	Operating system and application specific F4 behavior
fn and F5	Operating system and application specific F5 behavior
fn and F6	Operating system and application specific F6 behavior
fn and F8	Operating system and application specific F8 behavior
fn and F9	Operating system and application specific F9 behavior
fn and F10	Operating system and application specific F10 behavior
fn and F11	Operating system and application specific F11 behavior
fn and F12	Operating system and application specific F12 behavior
fn and Right Ctrl	Open application menu
fn and Cursor up	Page up
fn and Cursor down	Page down

Keys with alternate characters

There are other keys on your keyboard with alternate characters. The symbols that are shown at the bottom of these keys are the main characters that are displayed when the key is pressed; the symbols that are shown at the top of these keys are displayed when the key is pressed with the shift key. For example, if you press **2**, **2** is displayed; if you press **Shift** and **2**, **@** is displayed.

Camera

The following table lists the camera specifications of your Latitude 5540.

Table 17. Camera specifications

Description		Values
Number of cameras		One
Camera type		<ul style="list-style-type: none"> FHD RGB camera FHD RGB + IR camera FHD RGB+IR camera with Ambient Light Sensor, Express Sign-In with Presence Detection and Intelligent Privacy
Camera location		Front camera
Camera sensor type		CMOS sensor technology
Camera resolution:		
	Still image	2.07 megapixel
	Video	1920 x 1080 (FHD) at 30 fps
Infrared camera resolution:		
	Still image	0.23 megapixels
	Video	640 x 360 at 30 fps
Diagonal viewing angle:		
	Camera	80 degrees
	Infrared camera	86.6 degrees

Touchpad

The following table lists the touchpad specifications of your Latitude 5540.

Table 18. Touchpad specifications

Description		Values
Touchpad resolution:		>300 DPI
Touchpad dimensions:		
	Horizontal	115 mm (4.52 in.)
	Vertical	67 mm (2.64 in.)
Touchpad gestures		For more information about the touchpad gestures that are available on: <ul style="list-style-type: none"> Windows, see the Microsoft Knowledge Base article at Microsoft Support Site. Ubuntu, see Ubuntu Support Site.

Power adapter

The following table lists the power adapter specifications of your Latitude 5540.

Table 19. Power adapter specifications

Description		Option one	Opt ion two	Opt ion three
Type		<ul style="list-style-type: none"> 60 W AC adapter, USB-C 60 W AC adapter, USB-C, 2-pin 	65 W AC adapter	100 W AC adapter, USB-C
Power-adapter dimensions:				
	Height	22 mm (0.86 in.)	28 mm (1.10 in.)	122 mm (4.80 in.)
	Width	55 mm (2.16 in.)	112 mm (4.41 in.)	60 mm (2.36 in.)
	Depth	66 mm (2.59 in.)	26.50 (1.04 in.)	26.50 (1.04 in.)
Input voltage		100 VAC–240 VAC	100 VAC–240 VAC	100 VAC–240 VAC
Input frequency		50 Hz–60 Hz	50 Hz–60 Hz	50 Hz–60 Hz
Input current (maximum)		1.70 A	1.70 A	1.70 A
Output current (continuous)		<ul style="list-style-type: none"> 20 V/3 A (Continuous) 15 V/3 A (Continuous) 9 V/3 A (Continuous) 5 V/3 A (Continuous) 	<ul style="list-style-type: none"> 20 V/3 A 15 V/3 A 9 V/3 A 5 V/3 A 	<ul style="list-style-type: none"> 20 V/3 A (Continuous) 15 V/3 A (Continuous) 9 V/3 A (Continuous) 5 V/3 A (Continuous)

Table 19. Power adapter specifications (continued)

Description	Option one	Opt ion two	Opt ion thr ee
		5 V A (Continuous) • 1 3 5 V A (Continuous) / 9 3 V / 7 A (Continuous) • 9 A (Continuous) V • 5 / V 3 / A (Continuous) • 5 A (Continuous) V / 3 A (Continuous)	
Rated output voltage	20 VDC/15 VDC/9 VDC/5 VDC	20 VD C/ 15 VD C/9 VD C/5 VD C	20 VD C/ 15 VD C/9 VD C/5 VD C
Temperature range:			
Operating	0°C to 40°C (32°F to 104°F)	0°C to 40° C (32 °F to 104 °F)	0°C to 40° C (32 °F to 104 °F)
Storage	-20°C to 70°C (-4°F to 158°F)	-40 °C to 70° C (-4 °F to 158 °F)	-40 °C to 70° C (-4 °F to 158 °F)
 CAUTION: Operating and storage temperature ranges may differ among components, so operating or storing the device outside these ranges may impact the performance of specific components.			

Battery

The following table lists the battery specifications of your Latitude 5540.

Table 20. Battery specifications

Description		Option one	Option two	Option three	Option four
Battery type		3 cell, 42 WHr, Li-ion (polymer), ExpressCharge + ExpressCharge Boost	3 cell, 42 WHr, Li-ion (polymer), Long Cycle Life	3 cell, 54 WHr, Li-ion (polymer), ExpressCharge + ExpressCharge Boost	3 cell, 54 WHr, Li-ion (polymer), Long Cycle Life + ExpressCharge
Battery voltage		11.40 VDC	11.40 VDC	11.40 VDC	11.40 VDC
Battery weight (minimum)		0.19 kg (0.41 lb)	0.19 kg (0.41 lb)	0.22 kg (0.48 lb)	0.22 kg (0.48 lb)
Battery dimensions:					
	Height	5.73 mm (0.22 in.)	5.73 mm (0.22 in.)	5.73 mm (0.22 in.)	5.73 mm (0.22 in.)
	Width	263 mm (10.35 in.)	263 mm (10.35 in.)	263 mm (10.35 in.)	263 mm (10.35 in.)
	Depth	68.90 mm (2.71 in.)	68.90 mm (2.71 in.)	68.90 mm (2.71 in.)	68.90 mm (2.71 in.)
Temperature range:					
	Operating	<ul style="list-style-type: none"> Charge: 0°C to 45°C (32°F to 113°F) Discharge: 0°C to 70°C (32°F to 158°F) 	<ul style="list-style-type: none"> Charge: 0°C to 45°C (32°F to 113°F) Discharge: 0°C to 70°C (32°F to 158°F) 	<ul style="list-style-type: none"> Charge: 0°C to 45°C (32°F to 113°F) Discharge: 0°C to 70°C (32°F to 158°F) 	<ul style="list-style-type: none"> Charge: 0°C to 45°C (32°F to 113°F) Discharge: 0°C to 70°C (32°F to 158°F)
	Storage	-20°C to 65°C (4°F to 149°F)	-20°C to 65°C (4°F to 149°F)	-20°C to 65°C (4°F to 149°F)	-20°C to 65°C (4°F to 149°F)
Battery operating time		Varies depending on operating conditions and can significantly reduce under certain power-intensive conditions.	Varies depending on operating conditions and can significantly reduce under certain power-intensive conditions.	Varies depending on operating conditions and can significantly reduce under certain power-intensive conditions.	Varies depending on operating conditions and can significantly reduce under certain power-intensive conditions.
Battery charging time (approximate)		<ul style="list-style-type: none"> 35% in 20 minutes with ExpressCharge Boost 80% in 1 hour with standard charge 100% in 2 hours with standard charge 100% in 3 hours with standard charge 	<ul style="list-style-type: none"> 80% in 1 hour with standard charge 100% in 2 hours with standard charge 100% in 3 hours with standard charge 	<ul style="list-style-type: none"> 35% in 20 minutes with ExpressCharge Boost 80% in 1 hour with standard charge 100% in 2 hours with standard charge 100% in 3 hours with standard charge 	<ul style="list-style-type: none"> 80% in 1 hour with standard charge 100% in 2 hours with standard charge 100% in 3 hours with standard charge
Coin-cell battery		CR2032	CR2032	CR2032	CR2032

Table 20. Battery specifications (continued)

Description	Option one	Option two	Option three	Option four
<p>CAUTION: Operating and storage temperature ranges may differ among components, so operating or storing the device outside these ranges may impact the performance of specific components.</p>				
<p>CAUTION: Dell Technologies recommends that you charge the battery regularly for optimal power consumption. If your battery charge is depleted, connect the power adapter, turn on your computer, and then restart your computer to reduce the power consumption.</p>				

Display

The following table lists the display specifications of your Latitude 5540.

Table 21. Display specifications

Description	Option one	Option two	Option three
Display type	15-inch Full High Definition (FHD)	15-inch Full High Definition (FHD)	15-inch Full High Definition (FHD), ComfortView Plus Low Blue Light, Battery Saving
Touch options	No	Yes	No
Display-panel technology	In-Plane Switching (IPS)	In-Plane Switching (IPS)	In-Plane Switching (IPS)
Display-panel dimensions (active area):			
Height	193.60 mm (7.62 in.)	193.60 mm (7.62 in.)	193.60 mm (7.62 in.)
Width	344.20 mm (13.55 in.)	344.20 mm (13.55 in.)	344.20 mm (13.55 in.)
Diagonal	396 mm (15.60 in.)	396 mm (15.60 in.)	396 mm (15.60 in.)
Display-panel native resolution	1920 x 1080	1920 x 1080	1920 x 1080
Luminance (typical)	250 nits	250 nits	400 nits
Megapixels	2.07	2.07	2.07
Color gamut	45% NTSC	45% NTSC	100% sRGB
Pixels Per Inch (PPI)	141	141	141
Contrast ratio (typical)	700:1	700:1	800:1
Response time (maximum)	35 ms	35 ms	35 ms
Refresh rate	60 Hz	60 Hz	60 Hz
Horizontal view angle	80 +/- degrees	80 +/- degrees	80 +/- degrees
Vertical view angle	80 +/- degrees	80 +/- degrees	80 +/- degrees
Pixel pitch	0.179 x 0.179 mm	0.179 x 0.179 mm	0.179 x 0.179 mm
Power consumption (maximum)	4.60 W	4.60 W	4.50 W

Table 21. Display specifications (continued)

Description	Option one	Option two	Option three
Anti-glare vs glossy finish	Anti-glare	Anti-glare	Anti-glare

Fingerprint reader (optional)

The following table lists the specifications of the optional fingerprint-reader of your Latitude 5540.

Table 22. Fingerprint reader specifications

Description	Values
Sensor technology	Capacitive
Sensor resolution	500 dpi
Sensor pixel size	108 x 88

Sensor

The following table lists the sensor of your Latitude 5540.

Table 23. Sensor

Sensor support
Ambient Light Sensor
Accelerometer in the base: ST Micro LIS2DW12TR
Accelerometer in the hinge-up (Upsell config with Emza/ALS/IR camera): ST Micro LNG2DMTR

GPU—Integrated

The following table lists the specifications of the integrated Graphics Processing Unit (GPU) supported by your Latitude 5540.

Table 24. GPU—Integrated

Controller	External display support	Memory size	Processor
Intel UHD Graphics	One HDMI 2.0 port	single-channel memory	13 th Generation Intel Core i3
Intel Iris X ^e Graphics	One HDMI 2.0 port	dual-channel memory	13 th Generation Intel Core i5/17

GPU—Discrete

The following table lists the specifications of the discrete Graphics Processing Unit (GPU) supported by your Latitude 5540.

Table 25. GPU—Discrete

Controller	Memory size	Memory type
NVIDIA GeForce MX550	2 GB	GDDR6

External display support

The following table lists the external display support for your Latitude 5540.

Table 26. External display support

Graphics card	Supported external displays with laptop display enabled	Supported external displays with laptop display disabled
Intel Iris X ^e Graphics	3	4
Intel UHD Graphics	3	4
 NOTE: For more information about external display support, see the External Display Connection Guide on Dell Support Site .		

Hardware security

The following table lists the hardware security of your Latitude 5540.

Table 27. Hardware security

Hardware security
Trusted Platform Module (TPM) 2.0 discrete
FIPS 140-2 certification for TPM
TCG Certification for TPM (Trusted Computing Group)
Finger Print Reader in Power Button tied to ControlVault 3
ControlVault 3 Advanced Authentication with FIPS 140-2 Level 3 Certification
Contacted Smart Card and ControlVault 3
Contactless Smart Card, NFC, and ControlVault 3
SED SSD NVMe, SSD and HDD (Opal and non-Opal) per SDL
FIPS 201 Full Scan FPR and ControlVault 3

Smart-card reader

Contactless smart-card reader

This section lists the contactless smart-card reader specifications of your Latitude 5540. This module is only available in computers shipped with Smart-card readers.

Table 28. Contactless smart-card reader specifications

Title	Description	Dell ControlVault 3 contactless smart-card reader with NFC
Felica Card Support	Reader and software capable of supporting Felica contactless cards	Yes
ISO 14443 Type A Card Support	Reader and software capable of supporting ISO 14443 Type A contactless cards	Yes

Table 28. Contactless smart-card reader specifications (continued)

Title	Description	Dell ControlVault 3 contactless smart-card reader with NFC
ISO 14443 Type B Card Support	Reader and software capable of supporting ISO 14443 Type B contactless cards	Yes
ISO/IEC 21481	Reader and software capable of supporting ISO/IEC 21481 compliant contactless cards and tokens	Yes
ISO/IEC 18092	Reader and software capable of supporting ISO/IEC 21481 compliant contactless cards and tokens	Yes
ISO 15693 Card Support	Reader and software capable of supporting ISO15693 contactless cards	Yes
NFC Tag Support	Supports reading and processing of NFC compliant tag information	Yes
NFC Reader Mode	Support for NFC Forum Defined Reader mode	Yes
NFC Writer Mode	Support for NFC Forum Defined Writer mode	Yes
NFC Peer-to-Peer Mode	Support for NFC Forum Defined Peer to Peer mode	Yes
NFC Proximity OS Interface	Enumerates NFP (Near Field Proximity) device for OS to utilize	Yes
PC/SC OS interface	Personal Computer/Smart Card specification for integration of hardware readers into personal computer environments	Yes
CCID driver compliance	Common driver support for Integrated Circuit Card Interface Device for OS level drivers	Yes
Dell ControlVault support	Device connects to Dell ControlVault for usage and processing	Yes

 **NOTE:** 125 Khz proximity cards are not supported.

Table 29. Supported cards

Manufacturer	Card
HID	jCOP readertest3 A card (14443a)
	1430 1L
	DESFire D8H
	iClass (Legacy)
	iClass SEOS
NXP/Mifare	Mifare DESFire 8K White PVC Cards
	Mifare Classic 1K White PVC Cards
	NXP Mifare Classic S50 ISO Card
G&D	idOnDemand - SCE3.2 144K
	SCE6.0 FIPS 80K Dual+ 1 K Mifare

Table 29. Supported cards (continued)

Manufacturer	Card
	SCE6.0 nonFIPS 80K Dual+ 1 K Mifare
	SCE6.0 FIPS 144K Dual + 1K Mifare
	SCE6.0 nonFIPS 144K Dual + 1 K Mifare
	SCE7.0 FIPS 144K
Oberthur	idOnDemand - OCS5.2 80K
	ID-One Cosmo 64 RSA D V5.4 T=0 card

Contacted smart-card reader

The following table lists the contacted smart-card reader specifications of your Latitude 5540.

Table 30. Contacted smart-card reader specifications

Title	Description	Dell ControlVault 3 smart-card reader
ISO 7816 -3 Class A Card Support	Reader capable of reading 5V powered smart mcard	Yes
ISO 7816 -3 Class B Card Support	Reader capable of reading 3V powered smart card	Yes
ISO 7816 -3 Class C Card support	Reader capable of reading 1.8V powered smart card	Yes
ISO 7816-1 Compliant	Specification for the reader	Yes
ISO 7816 -2 Compliant	Specification for smart card device physical characteristics (size, location of connection points, etc.)	Not applicable
T=0 support	Cards support character level transmission	Yes
T=1 support	Cards support block level transmission	Yes
EMVCo Compliant	Compliant with EMVCo (for electronic payment standards) smart card standards as posted to www.emvco.com	Yes
EMVCo Certified	Formally certified based on EMVCO smart card standards	Yes
PC/SC OS interface	Personal Computer/Smart Card specification for integration of hardware readers into personal computer environments	Yes
CCID driver compliance	Common driver support for Integrated Circuit Card Interface Device for OS level drivers.	Yes
Windows Certified	Device certified by WHCK	Yes
FIPS 201 (PIV/HSPD-12) Compliant via GSA	Device compliant with FIPS 201/PIV/HSPD-12 requirements	Yes

Operating and storage environment

This table lists the operating and storage specifications of your Latitude 5540.

Airborne contaminant level: G1 as defined by ISA-S71.04-1985

Table 31. Computer environment

Description	Operating	Storage
Temperature range	0°C to 35°C (32°F to 95°F)	-40°C to 65°C (-40°F to 149°F)
Relative humidity (maximum)	10% to 90% (non-condensing)	0% to 95% (non-condensing)
Vibration (maximum)*	0.66 GRMS	1.30 GRMS
Shock (maximum)	110 G†	160 G†
Altitude range	-15.2 m to 3048 m (-49.87 ft to 10000 ft)	-15.2 m to 10668 m (-49.87 ft to 35000 ft)

 **CAUTION: Operating and storage temperature ranges may differ among components, so operating or storing the device outside these ranges may impact the performance of specific components.**

* Measured using a random vibration spectrum that simulates the user environment.

† Measured using a 2 ms half-sine pulse.

Dell support policy

For information about Dell support policy, search in the Knowledge Base Resource at [Dell Support Site](#).

ComfortView Plus

 **WARNING: Prolonged exposure to blue light from the display may lead to long-term effects such as eye strain, eye fatigue, or damage to the eyes.**

Blue light is a color in the light spectrum which has a short wavelength and high energy. Chronic exposure to blue light, particularly from digital sources may disrupt sleep patterns and cause long-term effects such as eye strain, eye fatigue, or damage to the eyes.

The display on this computer is designed to minimize blue light and complies with TÜV Rheinland's requirement for low blue light displays.

Low blue light mode is enabled at the factory, so no further configuration is necessary.

To reduce the risk of eye strain, it is also recommended that you:

- Position the display at a comfortable viewing distance between 20 and 28 inches (50 cm and 70 cm) from your eyes.
- Blink frequently to moisten your eyes, wet your eyes with water, or apply suitable eye drops.
- Take an extended break for 20 minutes every two hours.
- Look away from your display, and gaze at a distant object at 20 ft (609.60 cm) away for at least 20 seconds during each break.

Using the privacy shutter

1. Slide the privacy shutter to the left to access the camera lens.
2. Slide the privacy shutter to the right to cover the camera lens.



Figure 1. Camera shutter

Dell Optimizer

This section provides the Dell Optimizer specifications of your Latitude 5540.

On Latitude 5540 with Dell Optimizer, the following features are supported:









- **ExpressConnect**—Automatically joins the access point with the strongest signal, and directs bandwidth to conferencing applications when in use.
- **ExpressSign-in**—The Intel Context Sensing Technology's proximity sensor detects your presence to instantly wake up the computer and login using the IR camera and Windows Hello feature. Windows locks when you walk away.
- **ExpressResponse**—Prioritizes the most important applications. Applications open faster and perform better.
- **ExpressCharge**—Extends the battery runtime and improves battery performance by adapting to your patterns.
- **Intelligent Audio**—Collaborate like you're in the same room. Intelligent Audio enhances your audio quality and reduces background noises, so you can hear and be heard, creating a better conference experience for all.

For more information about configuring and using these features, see [Dell Optimizer User Guide](#).

Working inside your computer



Safety instructions

Use the following safety guidelines to protect your computer from potential damage and to ensure your personal safety. Unless otherwise noted, each procedure in this document assumes that you have read the safety information that shipped with your computer.

-  **WARNING:** Before working inside your computer, read the safety information that is shipped with your computer. For more safety best practices, see [Dell Regulatory Compliance Home Page](#).
-  **WARNING:** Disconnect your computer from all power sources before opening the computer cover or panels. After you finish working inside the computer, replace all covers, panels, and screws before connecting your computer to an electrical outlet.
-  **CAUTION:** To avoid damaging the computer, ensure that the work surface is flat, dry, and clean.
-  **CAUTION:** You should only perform troubleshooting and repairs as authorized or directed by the Dell technical support team. Damage due to servicing that is not authorized by Dell is not covered by your warranty. See the safety instructions that is shipped with the product or at [Dell Regulatory Compliance Home Page](#).
-  **CAUTION:** Before touching anything inside your computer, ground yourself by touching an unpainted metal surface, such as the metal at the back of the computer. While you work, periodically touch an unpainted metal surface to dissipate static electricity which could harm internal components.
-  **CAUTION:** To avoid damaging the components and cards, handle them by their edges, and avoid touching the pins and the contacts.
-  **CAUTION:** When you disconnect a cable, pull it by its connector or its pull tab, not the cable itself. Some cables have connectors with locking tabs or thumbscrews that you must disengage before disconnecting the cable. When disconnecting cables, keep them evenly aligned to avoid bending the connector pins. When connecting cables, ensure that the connector on the cable is correctly oriented and aligned with the port.
-  **CAUTION:** Press and eject any installed card from the media-card reader.
-  **CAUTION:** Exercise caution when handling rechargeable Li-ion batteries in laptops. Swollen batteries should not be used and should be replaced and disposed properly.

Before working inside your computer

Steps

1. Save and close all open files and exit all open applications.
2. Shut down your computer. For Windows operating system, click **Start** >  **Power** > **Shut down**.
 -  **NOTE:** If you are using a different operating system, see the documentation of your operating system for instructions.
3. Turn off all the attached peripherals.
4. Disconnect your computer from the electrical outlets.
5. Disconnect all attached network devices and peripherals, such as keyboard, mouse, and monitor from your computer.
6. Remove any media card and optical drive from your computer, if applicable.
7. Enter the Service Mode.

Service Mode

Service Mode is used to cut off power without disconnecting the battery cable from the system board before conducting repairs in the computer.

 **CAUTION:** If you are unable to turn on the computer to put it into Service Mode, proceed to disconnect the battery cable. To disconnect the battery cable, follow the steps in [Removing the battery](#).

 **NOTE:** Ensure that your computer is shut down and the power adapter is disconnected.

- a. Press and hold the B key and the power button for 3 seconds or until the Dell logo appears on the screen.
- b. Press any key to continue.
- c. If the power adapter is not disconnected, a message prompting you to disconnect the power adapter appears on the screen. Disconnect the power adapter and then press any key to enter into the Service Mode. The Service Mode process automatically skips the following step if the **Owner Tag** of the computer is not set up in advance by the user.
- d. When the **ready-to-proceed** message appears on the screen, press any key to proceed. The computer emits three short beeps and shuts down immediately.
The computer shuts down and enters the Service Mode.

Safety precautions

This section details the primary steps to be followed before performing any disassembly instructions.

Observe the following safety precautions before you perform any installation or break-fix procedures involving disassembly or reassembly:

- Turn off the computer and all attached peripherals.
- Disconnect the computer from AC power.
- Disconnect all network cables and peripherals from the computer.
- Use an ESD field service kit when working inside any to avoid electrostatic discharge (ESD) damage.
- Place the removed component on an anti-static mat after removing it from the computer.
- Wear shoes with nonconductive rubber soles to reduce the chance of getting electrocuted.
- Unplugging, pressing, and holding the power button for 15 seconds should discharge residual power in the system board.

Standby power

Dell products with standby power must be unplugged before you open the back cover. Systems that are equipped with standby power are powered while turned off. The internal power enables the computer to be remotely turned on (Wake-on-LAN) and suspended into a sleep mode and has other advanced power management features.

Bonding

Bonding is a method for connecting two or more grounding conductors to the same electrical potential. This is done by using a field service electrostatic discharge (ESD) kit. When connecting a bonding wire, ensure that it is connected to bare metal and never to a painted or nonmetal surface. Ensure that the wrist strap is secure and in full contact with your skin. Remove all jewelry, watches, bracelets, or rings before grounding yourself and the equipment.

Electrostatic discharge—ESD protection

ESD is a major concern when you handle electronic components, especially sensitive components such as expansion cards, processors, memory modules, and system boards. A slight charge can damage circuits in ways that may not be obvious, such as intermittent problems or a shortened product life span. As the industry pushes for lower power requirements and increased density, ESD protection is an increasing concern.

Due to the increased density of semiconductors used in recent Dell products, the sensitivity to static damage is now higher than in previous Dell products. For this reason, some previously approved methods of handling parts are no longer applicable.

Two recognized types of ESD damage are catastrophic and intermittent failures.

- **Catastrophic** – Catastrophic failures represent approximately 20 percent of ESD-related failures. The damage causes an immediate and complete loss of device functionality. An example of catastrophic failure is a memory module that has

received a static shock and immediately generates a "No POST/No Video" symptom with a beep code that is emitted for missing or nonfunctional memory.

- **Intermittent** – Intermittent failures represent approximately 80 percent of ESD-related failures. The high rate of intermittent failures means that most of the time when damage occurs, it is not immediately recognizable. The memory module receives a static shock, but the tracing is merely weakened and does not immediately produce outward symptoms that are related to the damage. The weakened trace may take weeks or months to melt, and in the meantime may cause degradation of memory integrity, intermittent memory errors, and so on.

Intermittent failures that are also called latent or "walking wounded" are difficult to detect and troubleshoot.

Perform the following steps to prevent ESD damage:

- Use a wired ESD wrist strap that is properly grounded. Wireless anti-static straps do not provide adequate protection. Touching the chassis before handling parts does not ensure adequate ESD protection on parts with increased sensitivity to ESD damage.
- Handle all static-sensitive components in a static-safe area. If possible, use anti-static floor pads and workbench pads.
- When unpacking a static-sensitive component from its shipping carton, do not remove the component from the anti-static packing material until you are ready to install the component. Before unwrapping the anti-static packaging, use the anti-static wrist strap to discharge the static electricity from your body. For more information about the wrist strap and ESD wrist strap tester, see [Components of an ESD Field Service Kit](#).
- Before transporting a static-sensitive component, place it in an anti-static container or packaging.

ESD Field Service kit

The unmonitored field service kit is the most commonly used service kit. Each Field Service kit includes three main components: anti-static mat, wrist strap, and bonding wire.

 **CAUTION: It is critical to keep ESD-sensitive devices away from internal parts that are insulated and often highly charged, such as plastic heat sink casings.**

Working Environment

Before deploying the ESD Field Service kit, assess the situation at the customer location. For example, deploying the kit for a server environment is different than for a desktop or laptop environment. Servers are typically installed in a rack within a data center; desktops or laptops are typically placed on office desks or cubicles. Always look for a large open flat work area that is free of clutter and large enough to deploy the ESD kit with additional space to accommodate the type of computer that is being repaired. The workspace should also be free of insulators that can cause an ESD event. On the work area, insulators such as styrofoam and other plastics should always be moved at least 12 inches or 30 centimeters away from sensitive parts before physically handling any hardware components.

ESD Packaging

All ESD-sensitive devices must be shipped and received in static-safe packaging. Metal, static-shielded bags are preferred. However, you should always return the damaged component using the same ESD bag and packaging that the new part arrived in. The ESD bag should be folded over and taped shut and all the same foam packing material should be used in the original box that the new part arrived in. ESD-sensitive devices should be removed from packaging only at an ESD-protected work surface, and parts should never be placed on top of the ESD bag because only the inside of the bag is shielded. Always place parts in your hand, on the anti-static mat, in the computer, or inside an ESD bag.

Components of an ESD Field Service kit

The components of an ESD Field Service kit are:

- **Anti-Static Mat** – The anti-static mat is dissipative and parts can be placed on it during service procedures. When using an anti-static mat, your wrist strap should be snug and the bonding wire should be connected to the anti-static mat and to any bare metal on the computer being worked on. Once deployed properly, service parts can be removed from the ESD bag and placed directly on the anti-static mat. ESD-sensitive items are safe in your hand, on the anti-static mat, in the computer, or inside an ESD bag.
- **Wrist Strap and Bonding Wire** – The wrist strap and bonding wire can be either directly connected between your wrist and bare metal on the hardware if the anti-static mat is not required, or connect to the anti-static mat to protect hardware that is temporarily placed on the mat. The physical connection of the wrist strap and bonding wire between your skin, the anti-static mat, and the hardware is known as bonding. Use only Field Service kits with a wrist strap, anti-static mat, and

bonding wire. Never use wireless wrist straps. Always be cautious that the internal wires of a wrist strap are prone to damage from normal wear and tear, and must be checked regularly with a wrist strap tester in order to avoid accidental ESD hardware damage. It is recommended to test the wrist strap and bonding wire at least once per week.

- **ESD Wrist Strap Tester** – The wires inside an ESD strap are prone to damage over time. When using an unmonitored kit, it is a best practice to regularly test the strap prior to each service, and at a minimum, test once per week. A wrist strap tester is the best method for doing this test. To perform the test, plug the bonding-wire of the wrist-strap into the tester while it is strapped to your wrist and push the button to test. A green LED is lit if the test is successful; a red LED is lit and an alarm sounds if the test fails.

 **NOTE:** It is recommended to always use the traditional wired ESD grounding wrist strap and protective anti-static mat when servicing Dell products. In addition, it is critical to keep sensitive parts separate from all insulator parts while servicing the computer.

Transporting sensitive components

When transporting ESD sensitive components such as replacement parts or parts to be returned to Dell, it is critical to place these parts in anti-static bags for safe transport.

After working inside your computer

About this task

 **CAUTION:** Leaving stray or loose screws inside your computer may severely damage your computer.

Steps

1. Replace all screws and ensure that no stray screws remain inside your computer.
2. Connect any external devices, peripherals, or cables you removed before working on your computer.
3. Replace any media cards, discs, or any other components that you removed before working on your computer.
4. Connect your computer and all attached devices to their electrical outlets.
5. Turn on your computer.

BitLocker

 **CAUTION:** If BitLocker is not suspended before updating the BIOS, the Bitlocker key is not recognized the next time you reboot the computer. You will then be prompted to enter the recovery key to progress, and the system displays a prompt for the recovery key on each reboot. If the recovery key is not known, this can result in data loss or an operating system reinstall. For more information, see Knowledge Article: [updating the BIOS on Dell systems with BitLocker enabled](#).

The installation of the following components triggers BitLocker:

- Hard disk drive or solid-state drive
- System board

Recommended tools

The procedures in this document may require the following tools:

- Phillips screwdriver #0/#1
- Plastic scribe

Screw list

- NOTE:** When removing screws from a component, it is recommended to note the screw type and the quantity of screws, and then place them in a screw storage box. This is to ensure that the correct number of screws and correct screw type is restored when the component is replaced.
- NOTE:** Some computers have magnetic surfaces. Ensure that the screws are not left attached to such surfaces when replacing a component.
- NOTE:** Screw color may vary depending on the configuration ordered.

Table 32. Screw list

Component	Screw type	Quantity	Screw image
5G WWAN bracket	M2x3	1	
5G WWAN thermal shield	M2x3	2	
M.2 2230 Solid-state drive in Slot 1 and Slot 2	M2x3	1	
Solid-state drive thermal shield in Slot 1	M2x3	2	
Assembly-inner frame	M2x3	12	
System fan	M2x4	2	
Heat sink	M2x4	1	
Display cable	M2x3	2	
Type-C bracket	M2x4	3	
System board	M2x3	3	
Power button	M2x2.5	2	
Keyboard	M2x2	21	
Display assembly	M2x3	2	
Display panel	M2.5x3.5	4	
Display hinges	M2.5x3.5	2	
Fingerprint-reader bracket	M2x3	1	

Table 32. Screw list (continued)

Component	Screw type	Quantity	Screw image
Smart-card reader	M2x2	2	

Major components of Latitude 5540

The following image shows the major components of Latitude 5540.

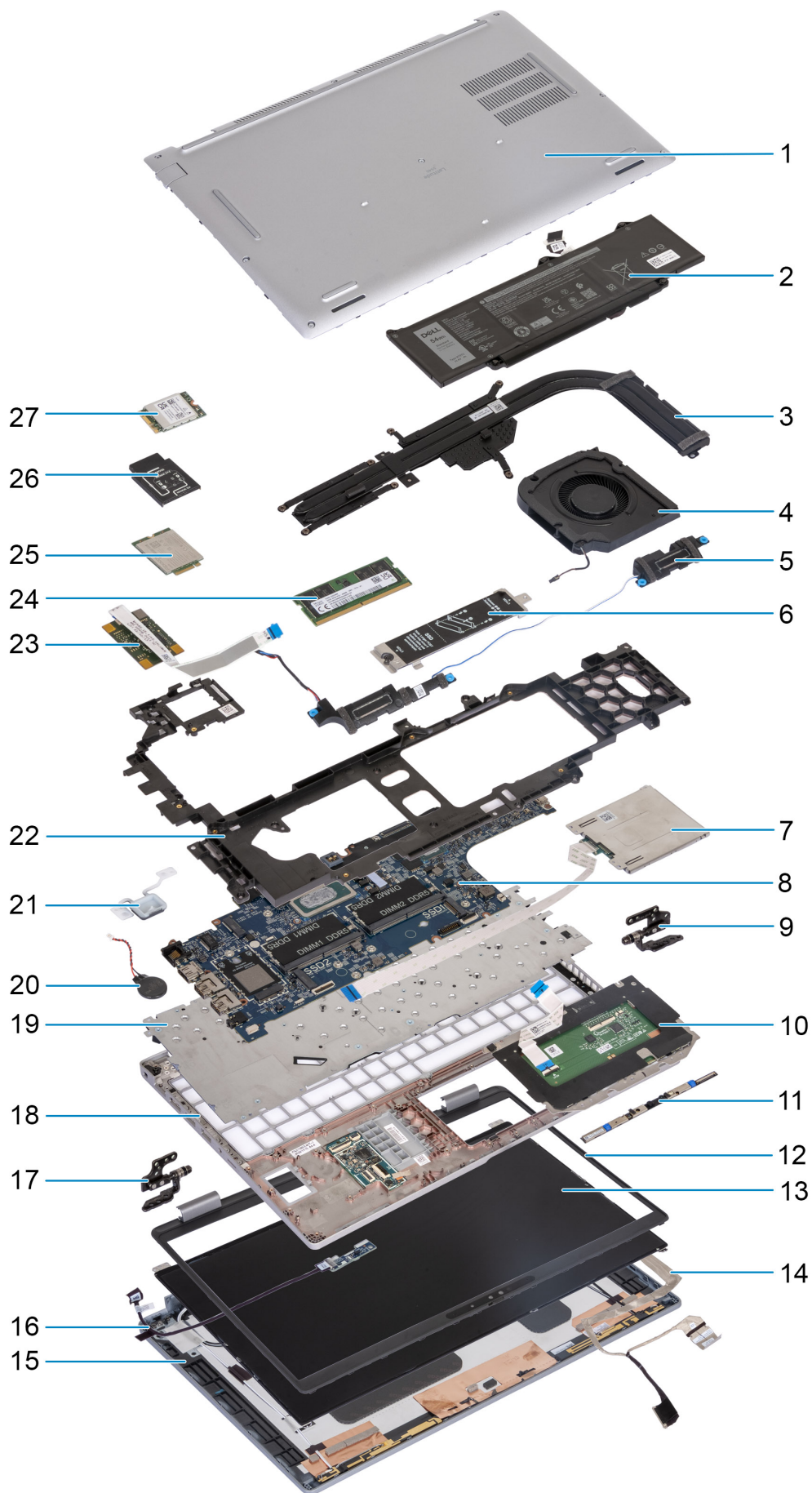

1. Base cover
3. Heat sink
5. Speakers
7. Smart card reader (optional)
9. Right hinges
11. Camera module
13. Display panel
15. Display back cover
17. Left hinges
19. Keyboard
21. Power button
23. Fingerprint reader
25. 4G WWAN card
27. WLAN card
2. Battery
4. System fan
6. M.2 2230/2280 solid-state drive thermal shield for solid-state drive Slot 1
8. System board
10. Touchpad
12. Display bezel
14. Display cable
16. Sensor board with cable
18. Palm-rest assembly
20. Coin-cell battery
22. Assembly inner frame
24. Memory module
26. 4G WWAN card bracket

 **NOTE:** Dell provides a list of components and their part numbers for the original system configuration purchased. These parts are available according to warranty coverages purchased by the customer. Contact your Dell sales representative for purchase options.

Removing and installing Customer Replaceable Units (CRUs)

The replaceable components in this chapter are Customer Replaceable Units (CRUs).

CAUTION: Customers can replace only the Customer Replaceable Units (CRUs) following the safety precautions and replacement procedures.

NOTE: The images in this document may differ from your computer depending on the configuration you ordered.

SIM card tray (optional)

Removing the SIM card tray

Prerequisites

1. Follow the procedure in [Before working inside your computer](#).

About this task

The following images indicate the location of the SIM card tray and provide a visual representation of the removal procedure.

This procedure is applicable to computers shipped with WWAN card only.



Figure 2. Removing the SIM card tray

Steps

1. Insert a pin into the release hole to release the SIM card tray.
2. Push the pin to disengage the lock, and eject the SIM card tray.

3. Slide the SIM card tray out of the slot on the computer.

Installing the SIM card tray

Prerequisites

If you are replacing a component, remove the existing component before performing the installation procedure.

About this task

The following images indicate the location of the SIM card tray and provide a visual representation of the removal procedure. This procedure is applicable to computers shipped with WWAN card only.

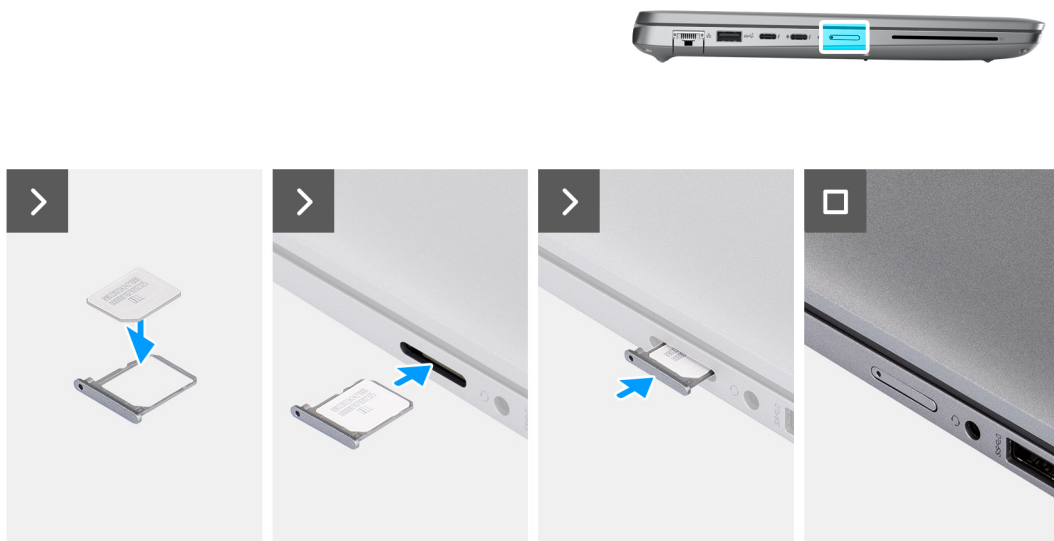

Figure 3. Installing the SIM card tray

Steps

1. Align and place the SIM card in the dedicated slot on the SIM card tray.
2. Slide the SIM card tray into the slot in the computer, and push it to lock in place.

Next steps

1. Follow the procedure in [After working inside your computer](#).

SIM card

Removing the SIM card

Prerequisites

1. Follow the procedure in [Before working inside your computer](#).

NOTE: The procedure for SIM card tray removal is only applicable for computers that are shipped with a WWAN module.

CAUTION: Removing the SIM card when the computer is turned on might cause data loss or damage to the card. Ensure that your computer is turned off or the network connections are disabled.

About this task

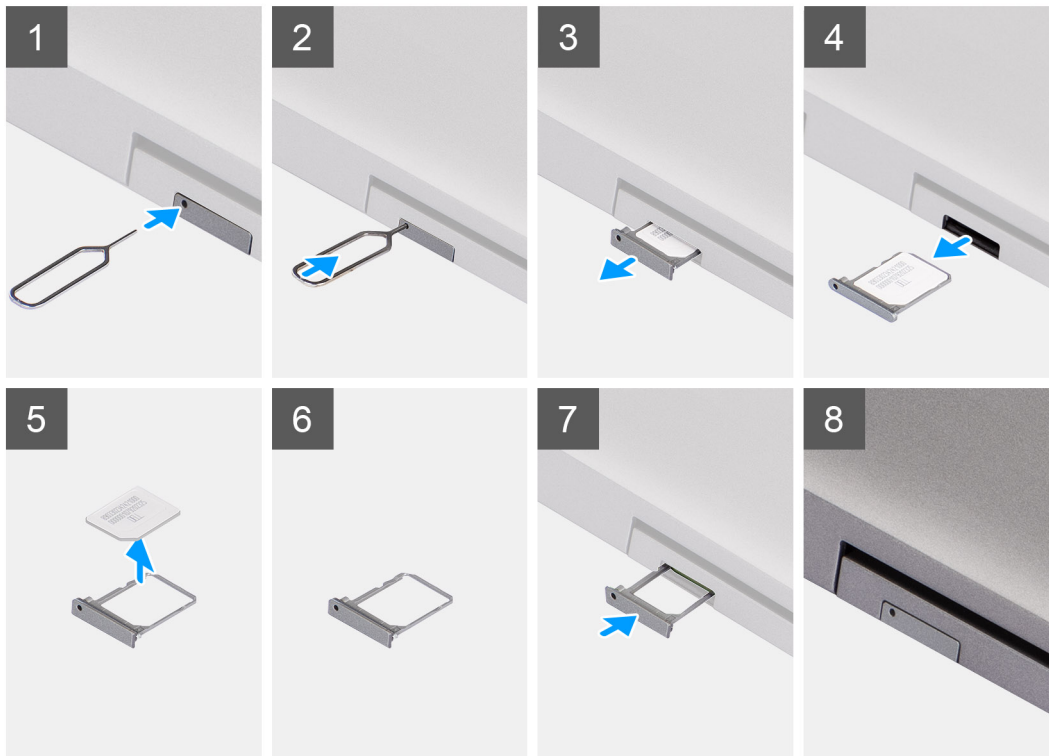

Figure 4. Removing the SIM card

Steps

1. Insert a pin into the release hole to release the SIM card tray.
2. Push the pin to disengage the lock, and eject the SIM card tray.
3. Slide the SIM card tray out of the slot on the computer.
4. Remove the SIM card from the SIM card tray.
5. Slide and push the SIM card tray back into the slot.

Installing the SIM card

Prerequisites

i **NOTE:** The procedure for SIM card tray installation is only applicable for computers that are shipped with a WWAN module.

If you are replacing a component, remove the existing component before performing the installation procedure.

About this task

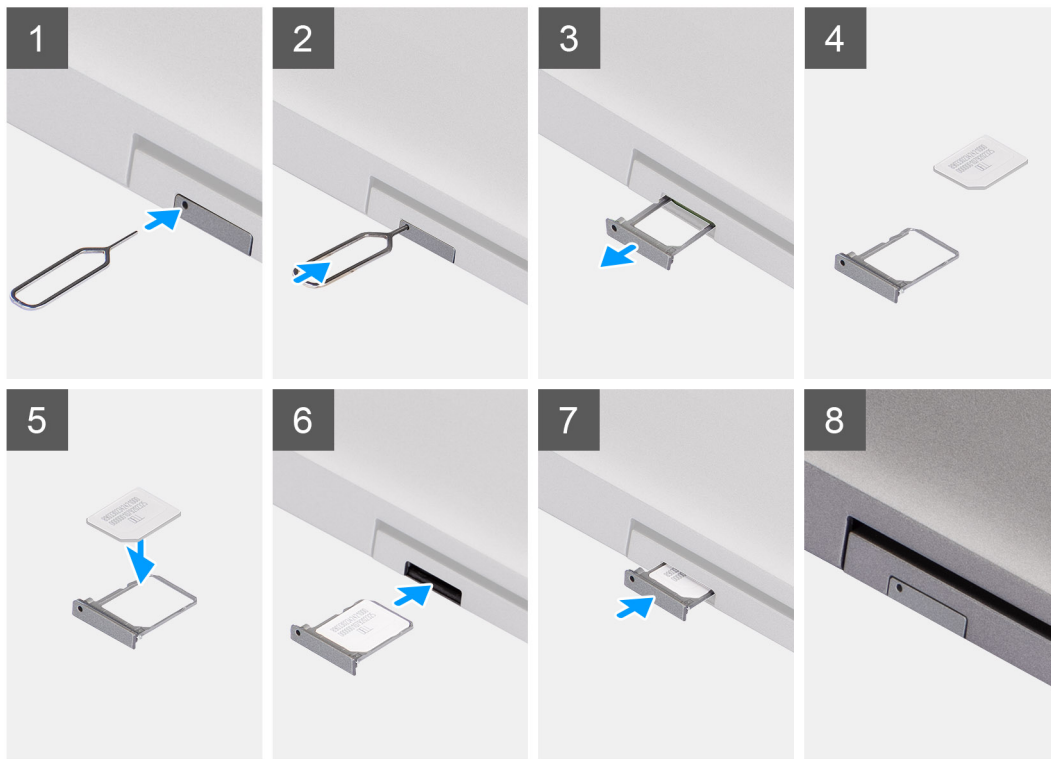

Figure 5. Installing the SIM card

Steps

1. Insert a pin into the release hole to release the SIM card tray.
2. Push the pin to disengage the lock, and eject the SIM card tray.
3. Slide the SIM card tray out of the slot on the computer.
4. Align and place the SIM card in the dedicated slot on the SIM card tray, with the metallic contact of the SIM card facing up.
5. Align the SIM card tray with the slot on the computer and carefully slide it in.
6. Slide the SIM card tray into the slot, until it clicks into place.

Next steps

1. Follow the procedure in [After working inside your computer](#).

Base cover

Removing the base cover

Prerequisites

1. Follow the procedure in [Before working inside your computer](#).

 **NOTE:** Ensure that your computer is in Service Mode. For more information, see [Before working inside your computer](#).

CAUTION: If you are unable to turn on the computer, if your computer is unable to enter Service Mode, or the computer does not support Service Mode, go to disconnect the battery cable.

2. Remove the SIM card.

About this task

NOTE: Before removing the base cover, ensure that there is no SD card that is installed in the SD card slot on your computer.

The following images indicate the location of the base cover and provide a visual representation of the removal procedure.



Figure 6. Image: Base cover

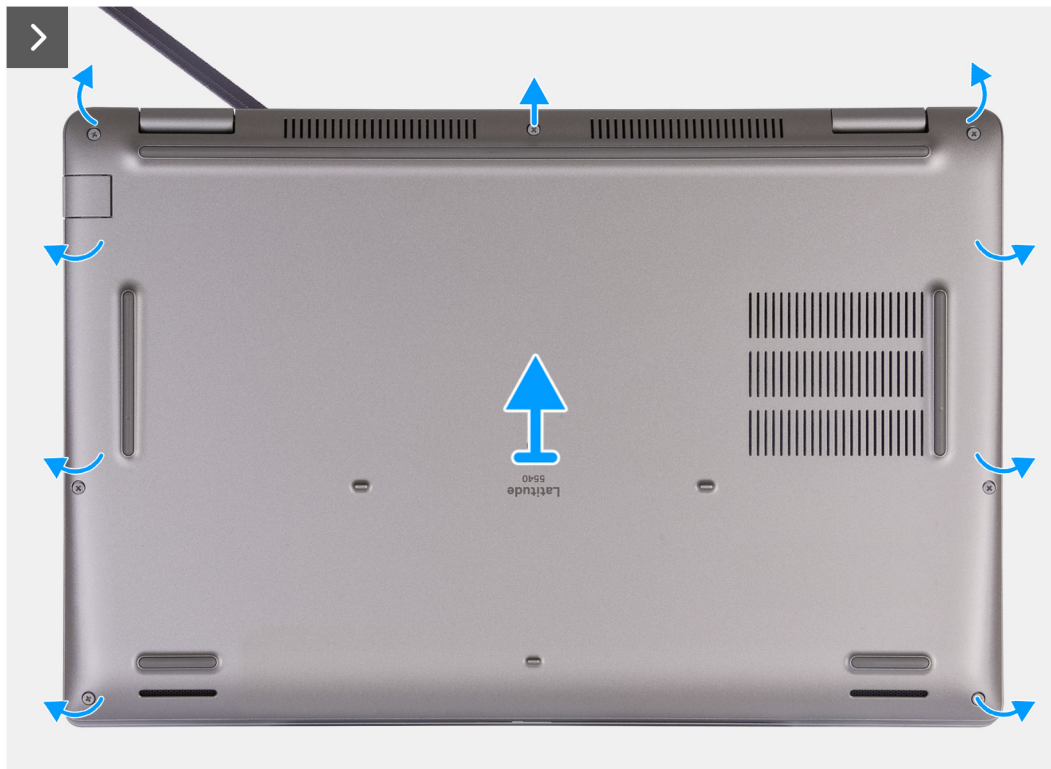

Figure 7. Image: Base cover

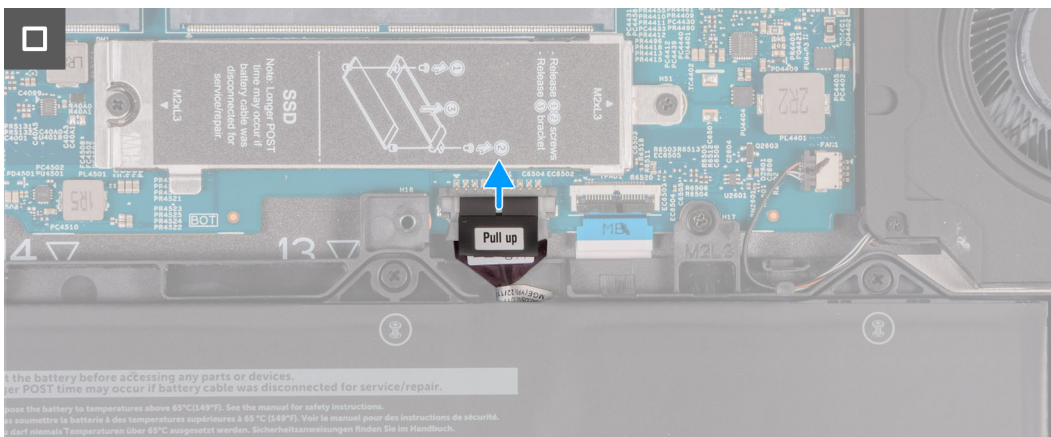

Figure 8. Image: Base cover

Steps

1. Loosen the eight captive screws that secure the base cover to the palm-rest assembly.
2. Using a plastic scribe, pry open the base cover from the recesses that are located in the U-shaped indents at the top edge of the base cover near the hinges.
3. Lift the base cover off the keyboard and palm-rest assembly.
 - NOTE:** Ensure that your computer is in Service Mode. If your computer is unable to enter Service Mode, disconnect the battery cable from the system board. To disconnect the battery cable, follow steps 4 and 5.
4. Disconnect the battery cable from the system board.
5. Press and hold the power button for five seconds to ground the computer and drain the flea power.

Installing the base cover

Prerequisites

If you are replacing a component, remove the existing component before performing the installation process.

About this task

The following images indicate the location of the base cover and provide a visual representation of the installation procedure.

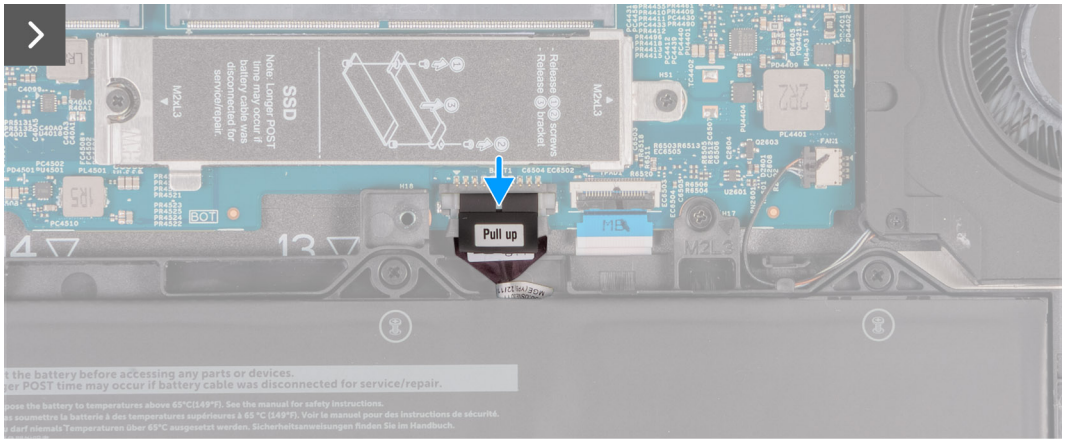

Figure 9. Image: Base cover

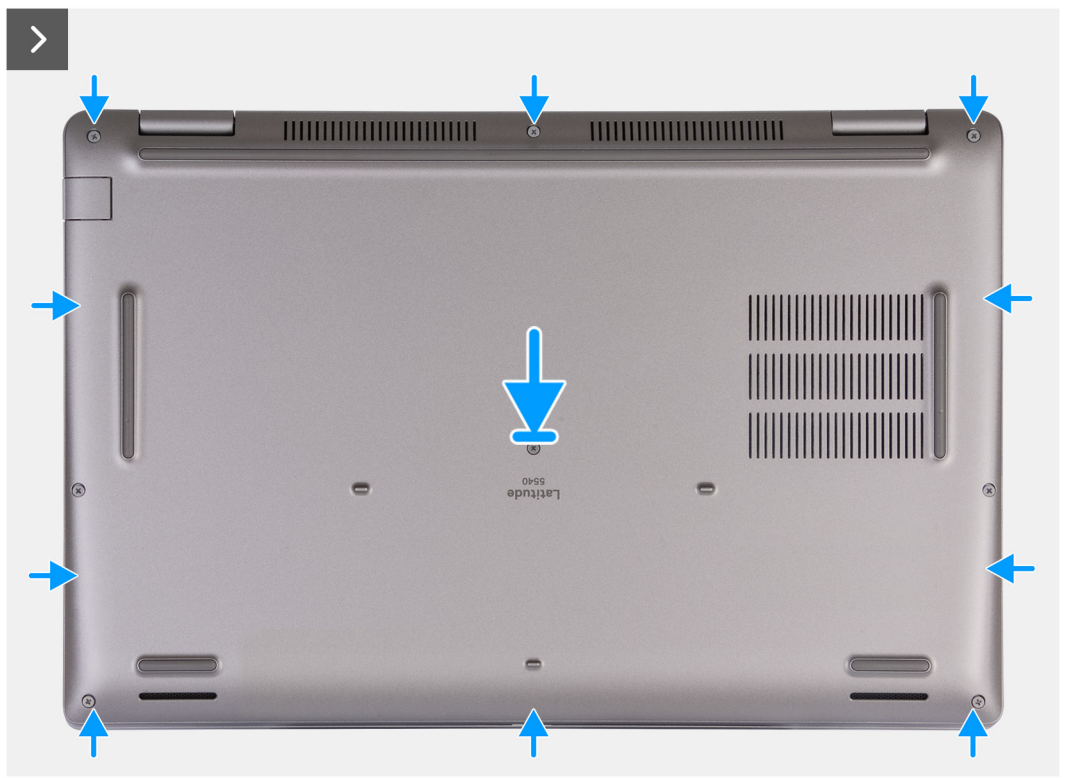

Figure 10. Image: Base cover



Figure 11. Image: Base cover

NOTE:

If the battery is not a pre-requisite and if you have disconnected the battery cable, ensure to connect the battery cable. To connect the battery cable, follow step 1 and step 2 in the procedure.

Steps

1. Connect the battery cable to the connector on the system board.
2. Align the screw holes on the base cover with the screw holes on the palm-rest and keyboard assembly, and then snap the base cover into place.
3. Tighten the eight captive screws that secure the base cover to the palm-rest and keyboard assembly.

Next steps

1. Install the [SIM card](#).
2. Follow the procedure in [After working inside your computer](#).

NOTE: Ensure that your computer is in Service Mode. For more information, see [Before working inside your computer](#)

Wireless card

Removing the WLAN card

Prerequisites

1. Follow the procedure in [Before working inside your computer](#).
2. Remove the [base cover](#).

About this task

The following image(s) indicate the location of the WLAN card and provides a visual representation of the removal procedure.



Figure 12. Image: WLAN card

Steps

1. Loosen the screw (M2x3) that secures the WLAN-card bracket to the WLAN card and palm-rest and keyboard assembly.
2. Lift the WLAN-card bracket off the WLAN card.
3. Disconnect the antenna cables from the WLAN card.
4. Slide and remove the wireless card off the WLAN-card slot.

Installing the WLAN card

Prerequisites

If you are replacing a component, remove the existing component before performing the installation process.

About this task

The following image(s) indicate the location of the WLAN card and provides a visual representation of the installation procedure.



Figure 13. Image: WLAN card

Steps

1. Connect the antenna cables to the WLAN card.

The following table provides the antenna-cable color scheme for the WLAN card that is supported by your computer.

Table 33. Antenna-cable color scheme

Connectors on the wireless card	Antenna-cable color	Silkscreen marking	
Main	White	MAIN	△ (white triangle)

Table 33. Antenna-cable color scheme (continued)

Connectors on the wireless card	Antenna-cable color	Silkscreen marking	
Auxiliary	Black	AUX	▲ (black triangle)

2. Align the notch on the WLAN card with the tab on the WLAN-card slot.
3. Adhere the WLAN card at an angle into the WLAN-card slot.
4. Align the screw hole on the WLAN-card bracket with the screw hole on the WLAN card and palm-rest and keyboard assembly.
5. Place the screw (M2x3) that secures the WLAN-card bracket to the WLAN card and the palm-rest and keyboard assembly.

Next steps

1. Install the [base cover](#).
2. Follow the procedure in [After working inside your computer](#).

WWAN card (Optional)

Removing the 4G WWAN card (Optional)

Prerequisites

1. Follow the procedure in [Before working inside your computer](#).
2. Remove the [base cover](#).

About this task

 **NOTE:** The following steps are for computers with WWAN support.

The following image(s) indicate the location of the 4G WWAN card and provides a visual representation of the removal procedure.



1x
M2x3

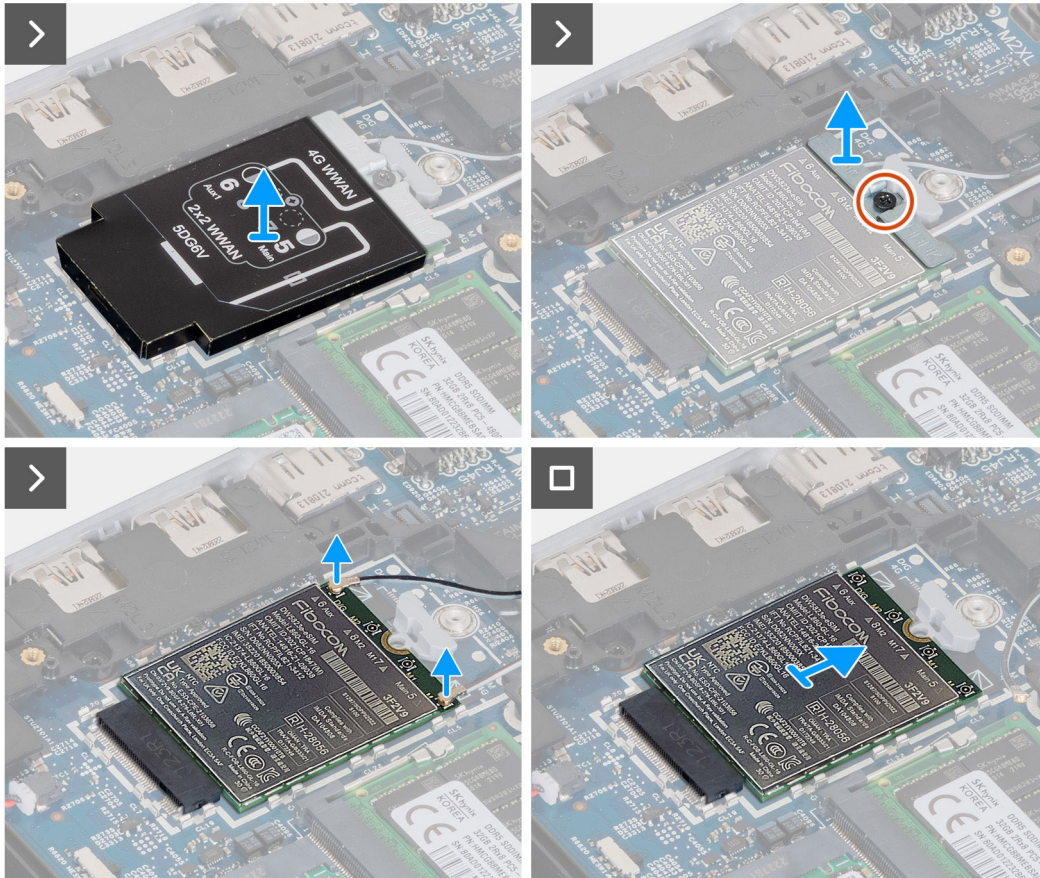
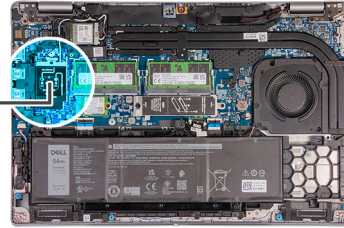

Figure 14. Image: WWAN card

Steps

1. Lift the 4G WWAN-card shield off the 4G WWAN card.
2. Remove the screw (M2x3) that secures the 4G WWAN-card bracket to the 4G WWAN card.
3. Lift the 4G WWAN-card bracket off the 4G WWAN card.
4. Disconnect the antenna cables from the 4G WWAN card.
5. Slide and remove the 4G WWAN card off the 4G WWAN-card slot on the system board.

Installing the 4G WWAN card (Optional)

Prerequisites

If you are replacing a component, remove the existing component before performing the installation process.

About this task

 **NOTE:** The following steps are for computers with WWAN support.

The following image(s) indicate the location of the 4G WWAN card and provide a visual representation of the installation procedure.

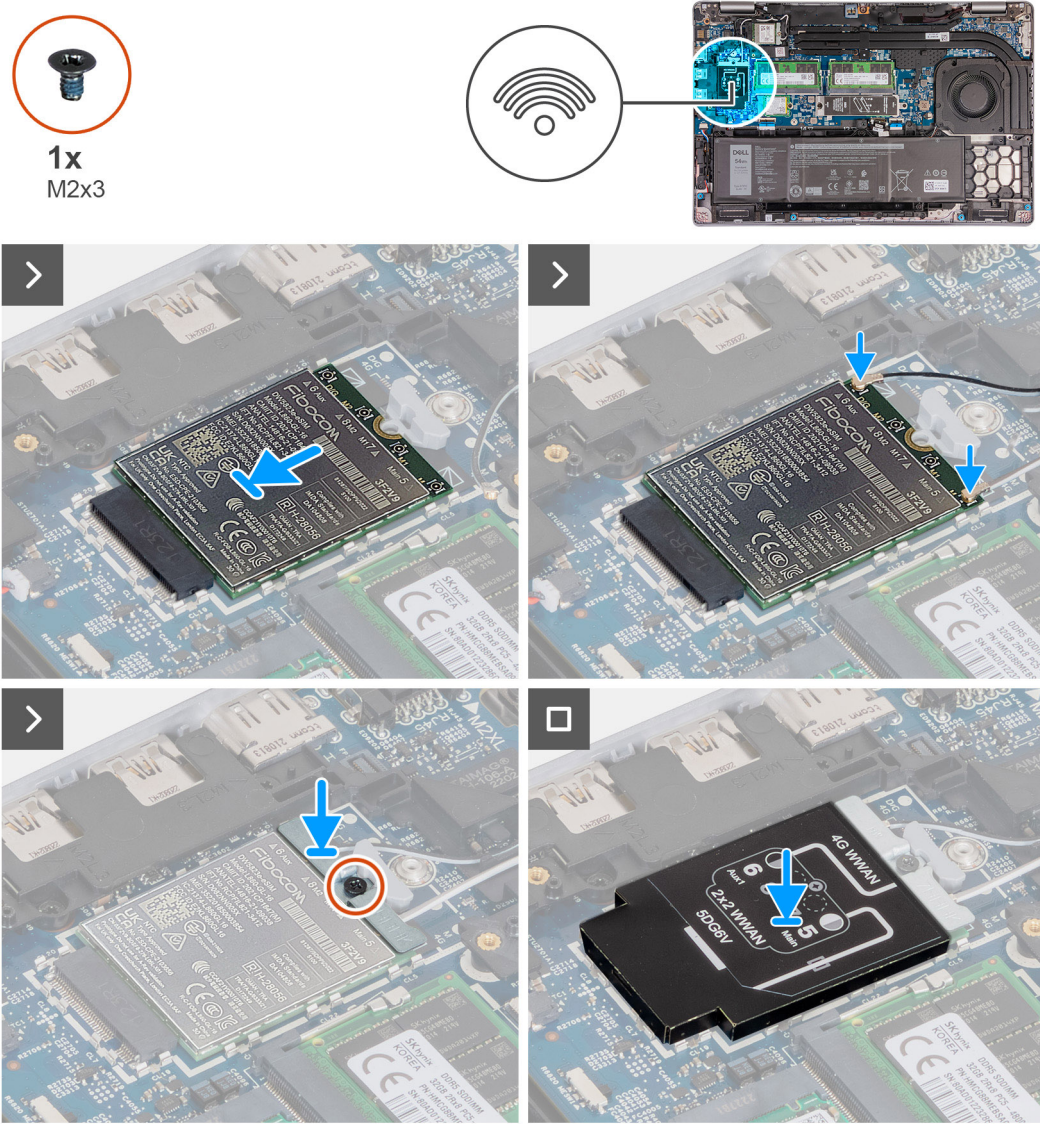

Figure 15. Image: WWAN card

Steps

1. Align the notch on the 4G WWAN card with the tab on the 4G WWAN-card slot.
2. Insert the 4G WWAN card at an angle into the 4G WWAN-card slot .
3. Connect the antenna cables to the 4G WWAN card.

The following table provides the antenna-cable color scheme for the 4G WWAN card that is supported by your computer.

Table 34. Antenna-cable color scheme

Connectors on the WWAN card	Antenna-cable color	Silkscreen marking	
D/G	Black with a thin white stripe	6 Aux	△ (white triangle)
M2	Blue	8 M2	△ (white triangle)
M1	Orange	7 M1	△ (white triangle)

Table 34. Antenna-cable color scheme (continued)

Connectors on the WWAN card	Antenna-cable color	Silkscreen marking	
M	White with a thin gray stripe	Main 5	▲ (black triangle)

4. Align the screw hole on the 4G WWAN-card bracket with the screw hole on the 4G WWAN card.
5. Replace the screw (M2x3) that secures the 4G WWAN bracket to the 4G WWAN card.
6. Align and place the 4G WWAN-card shield over the 4G WWAN card.

Next steps

1. Install the [base cover](#).
2. Follow the procedure in [After working inside your computer](#).

Removing the 5G WWAN card (Optional)

Prerequisites

1. Follow the procedure in [Before working inside your computer](#).
2. Remove the [base cover](#).

About this task

 **NOTE:** The following steps are for computers with WWAN support.

The following image(s) indicate the location of the 5G WWAN card and provides a visual representation of the removal procedure.



3x
M2x3

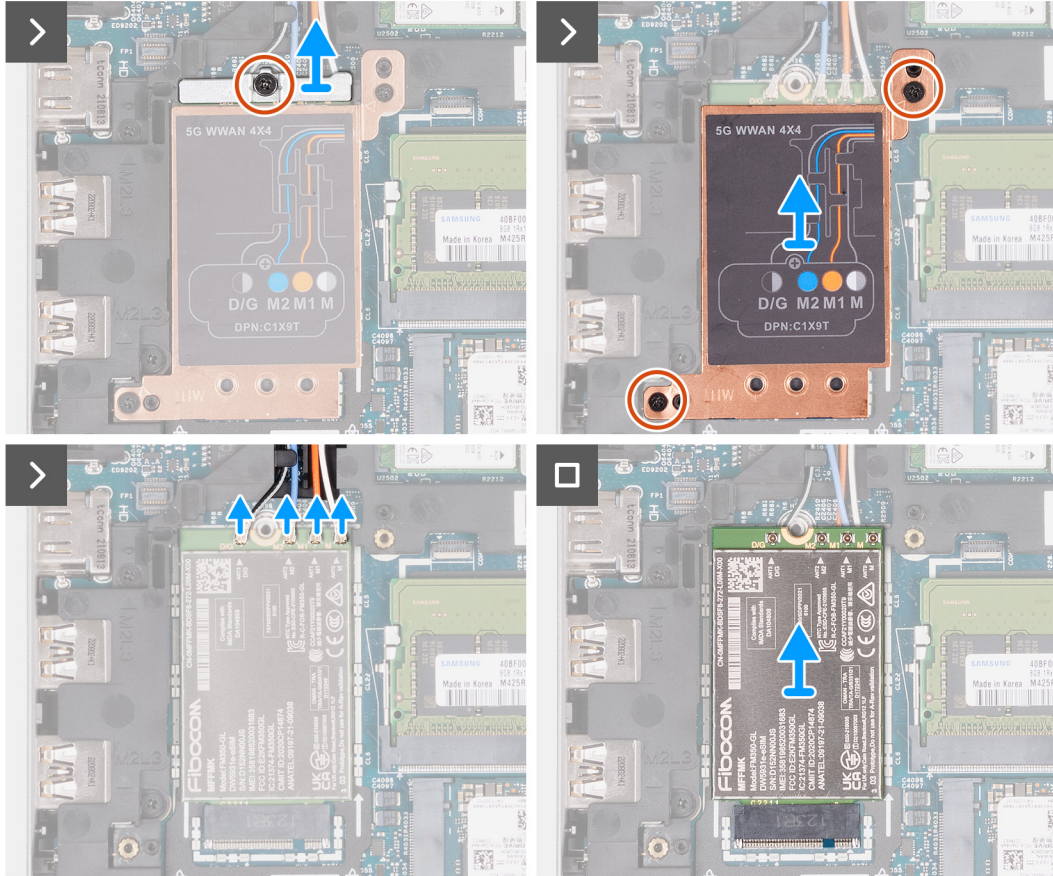
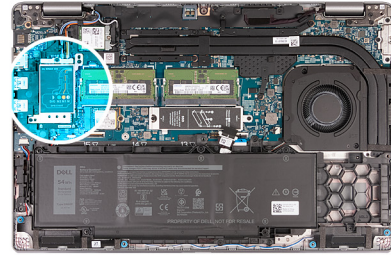

Figure 16. Image: WWAN card

Steps

1. Remove the screw (M2x3) that secures the 5G WWAN-card bracket to the 5G WWAN card.
2. Lift the 5G WWAN-card bracket off the 5G WWAN card.
3. Remove the two screws (M2x3) that secure the 5G WWAN-card shield to the palm-rest and keyboard assembly.
4. Lift the 5G WWAN-card shield off the 5G WWAN card.
5. Disconnect the antenna cables from the 5G WWAN card.
6. Slide and remove the 5G WWAN card off the 5G WWAN-card slot on the system board.

Installing the 5G WWAN card (Optional)

Prerequisites

If you are replacing a component, remove the existing component before performing the installation process.

About this task

 **NOTE:** The following steps are for computers with WWAN support.

The following image(s) indicate the location of the 5G WWAN card and provides a visual representation of the installation procedure.

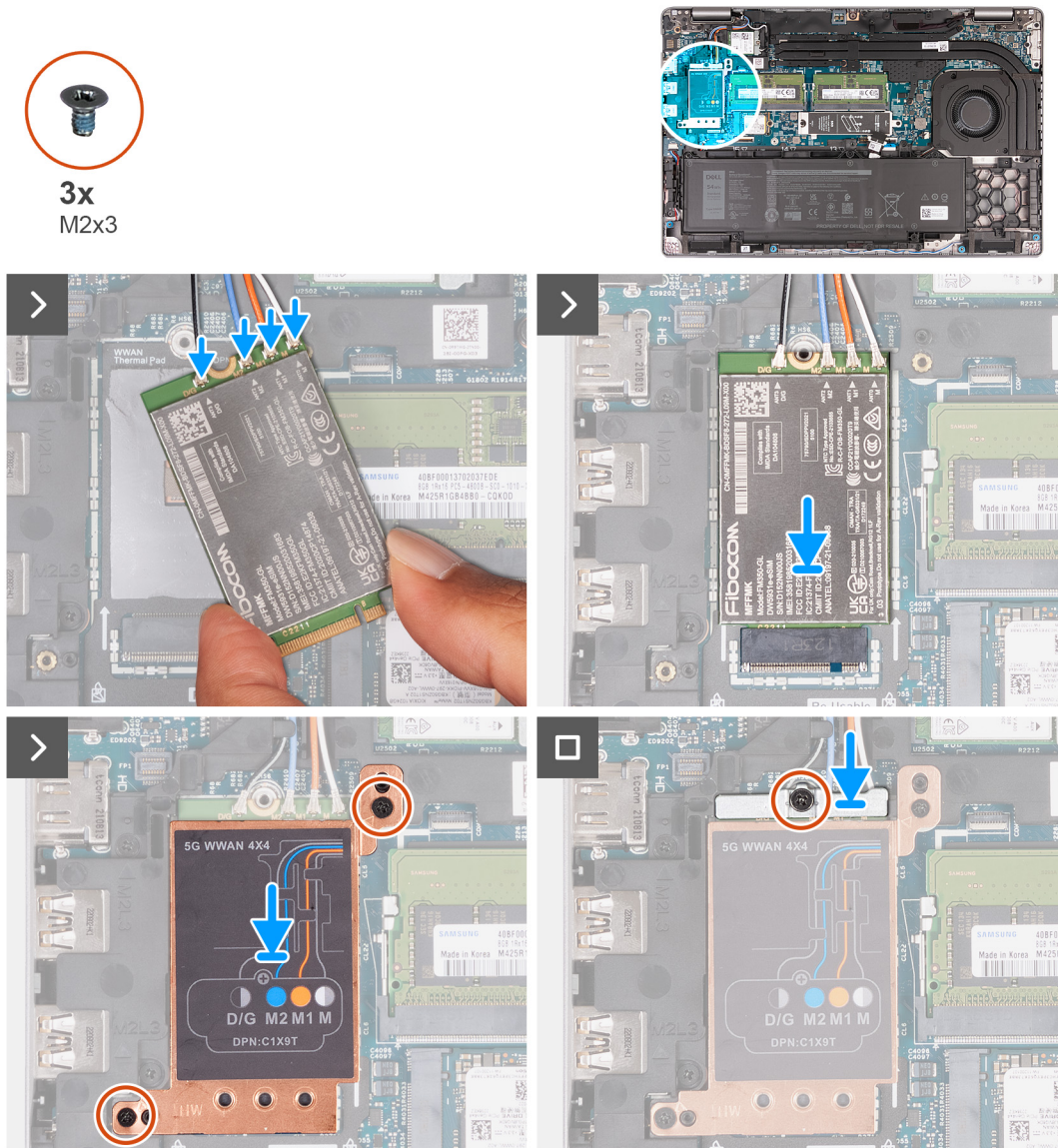

Figure 17. Image: WWAN card

Steps

1. Connect the antenna cables to the 5G WWAN card.

The following table provides the antenna-cable color scheme for the 5G WWAN card that is supported by your computer.

Table 35. Antenna-cable color scheme

Connectors on the WWAN card	Antenna-cable color	Silkscreen marking	
D/G	Black with a thin white stripe	ANT3 D/G	△ (white triangle)
M2	Blue	ANT2 M2	△ (white triangle)
M1	Orange	ANT1 M1	△ (white triangle)
M	White with a thin gray stripe	ANT0 M	△ (white triangle)

2. Align the notch on the 5G WWAN card with the tab on the 5G WWAN-card slot.
3. Insert the 5G WWAN card at an angle into the 5G WWAN-card slot .
4. Align the screw holes on the 5G WWAN-card shield with the screw holes on the palm-rest and keyboard assembly.
5. Replace the two screws (M2x3) that secure the 5G WWAN-card shield to the palm-rest and keyboard assembly.
6. Align the screw hole on the 5G WWAN-card bracket with the screw hole on the 5G WWAN card.
7. Replace the screw (M2x3) that secures the 5G WWAN bracket to the 5G WWAN card.

Next steps

1. Install the [base cover](#).
2. Follow the procedure in [After working inside your computer](#).

Memory module

Removing the memory module

Prerequisites

1. Follow the procedure in [Before working inside your computer](#).
2. Remove the [SIM card](#).
3. Remove the [base cover](#).

About this task

The following image(s) indicate the location of the memory module and provides a visual representation of the removal procedure.

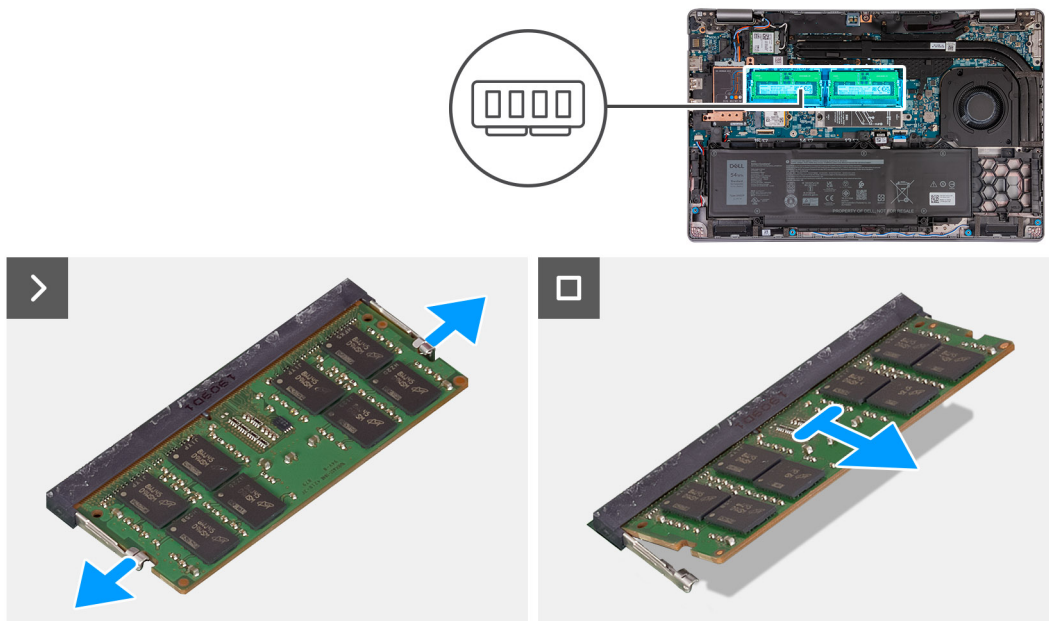

Figure 18. Image: Memory module

Steps

1. Using your fingertips, spread apart the securing clips on the memory-module slot until the memory module pops up.
2. Slide and remove the memory module from the memory-module slot on the system board.

CAUTION: To prevent damage to the memory module, hold the memory module by the edges. Do not touch the components or metallic contacts on the memory module as electrostatic discharge (ESD) can inflict severe damage on the components. To read more about ESD protection, see [ESD protection](#).

NOTE: Repeat step 1 and step 2 if there are more than one memory module installed on your computer.

Installing the memory module

Prerequisites

If you are replacing a component, remove the existing component before performing the installation process.

About this task

The following image(s) indicate the location of the memory module and provides a visual representation of the installation procedure.

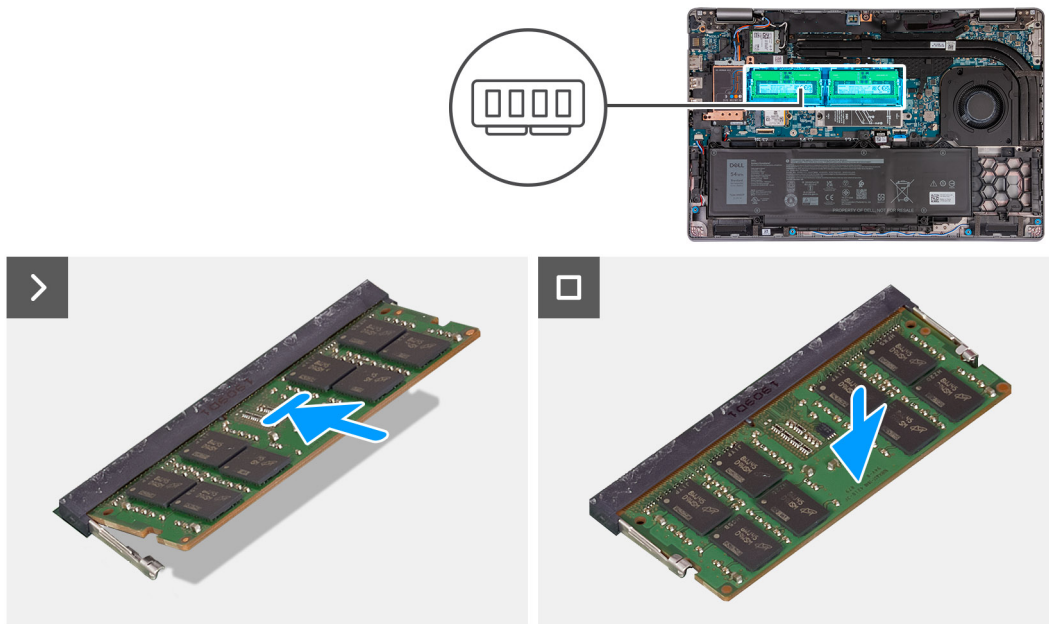

Figure 19. Image: Memory module

Steps

1. Align the notch on the memory module with the tab on the memory-module slot.
2. Slide the memory module firmly into the slot at an angle and press the memory module down until it clicks into place.

NOTE: If you do not hear the click, remove the memory module and reinstall it.

Next steps

1. Install the [base cover](#).
2. Install the [SIM card](#).
3. Follow the procedure in [After working inside your computer](#).

Solid-state drive

Removing the M.2 2230 solid-state drive from Slot 1

Prerequisites

1. Follow the procedure in [Before working inside your computer](#).

2. Remove the [SIM card](#).
3. Remove the [base cover](#).

About this task

The following image(s) indicate the location of the M.2 2230 solid-state drive in Slot 1 and provides a visual representation of the removal procedure.

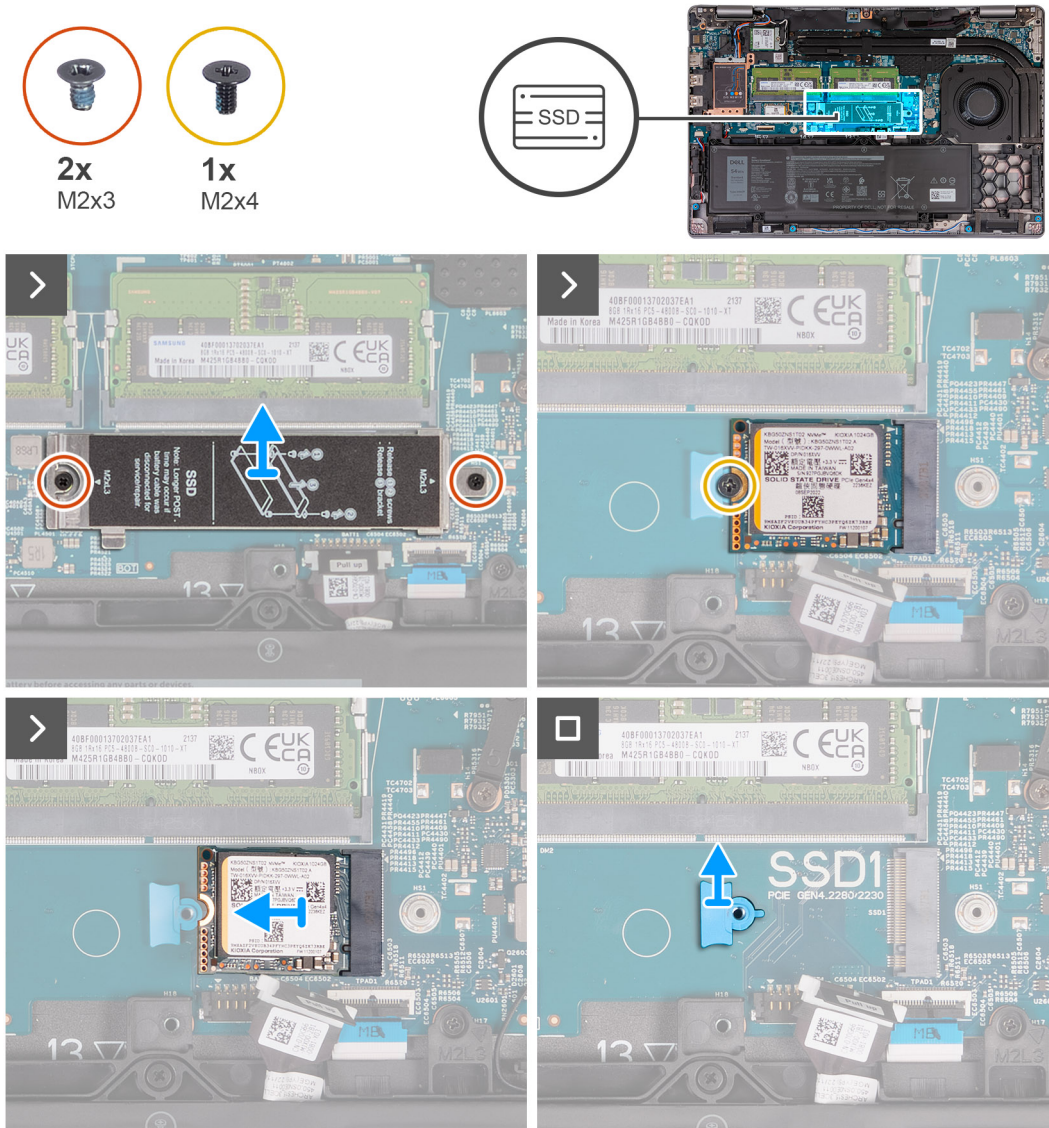

Figure 20. Image: Removing the M.2 2230 solid-state drive from Slot 1

Steps

1. Remove the two screws (M2x3) that secure the solid-state drive thermal shield to the palm-rest assembly.
2. Lift the solid-state drive thermal shield off the palm-rest assembly.
3. Remove the screw (M2x4) that secures the M.2 2230 solid-state drive to the solid-state drive bracket and palm-rest assembly.
4. Slide and lift the M.2 2230 solid-state drive off the solid-state drive slot.
5. Remove the M.2 2230 solid-state drive mounting bracket from the palm-rest assembly.

Installing the M.2 2230 solid-state drive in Slot 1

Prerequisites

If you are replacing a component, remove the existing component before performing the installation process.

About this task

The following image(s) indicate the location of the M.2 2230 solid-state drive in Slot 1 and provides a visual representation of the installation procedure.

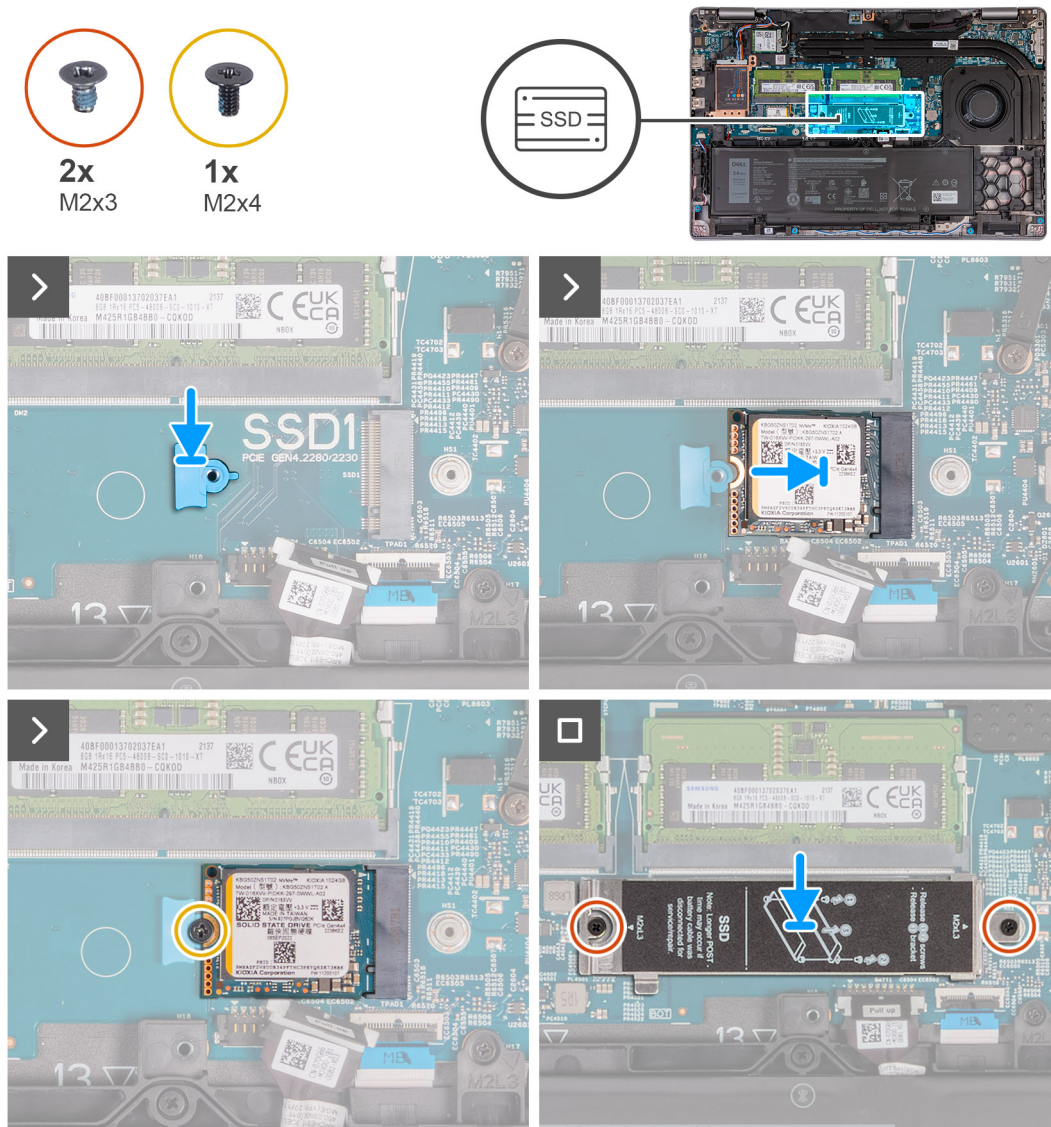

Figure 21. Installing the M.2 2230 solid-state drive in Slot 1

Steps

1. Place the M.2 2230 solid-state drive mounting bracket on its slot on the palm-rest assembly.
2. Align the notch on the M.2 2230 solid-state drive with the tab on the M.2 2230 solid-state drive slot.
3. Slide the M.2 2230 solid-state drive into the M.2 2230 solid-state drive slot.
4. Replace the screw (M2x4) that secures the M.2 2230 solid-state drive to the solid-state drive mounting bracket and palm-rest assembly.
5. Align the screw holes on the solid-state drive thermal shield with the screw holes on the M.2 2230 solid-state drive and palm-rest assembly.

- Replace the two screws (M2x3) that secure the solid-state drive thermal shield to the M.2 2230 solid-state drive and palm-rest assembly.

Next steps

- Install the [base cover](#).
- Install the [SIM card](#).
- Follow the procedure in [After working inside your computer](#).

Removing the M.2 2280 solid-state drive from Slot 1

Prerequisites

- Follow the procedure in [Before working inside your computer](#).
- Remove the [SIM card](#).
- Remove the [base cover](#).

About this task

The following image(s) indicate the location of the M.2 2280 solid-state drive in Slot 1 and provides a visual representation of the removal procedure.

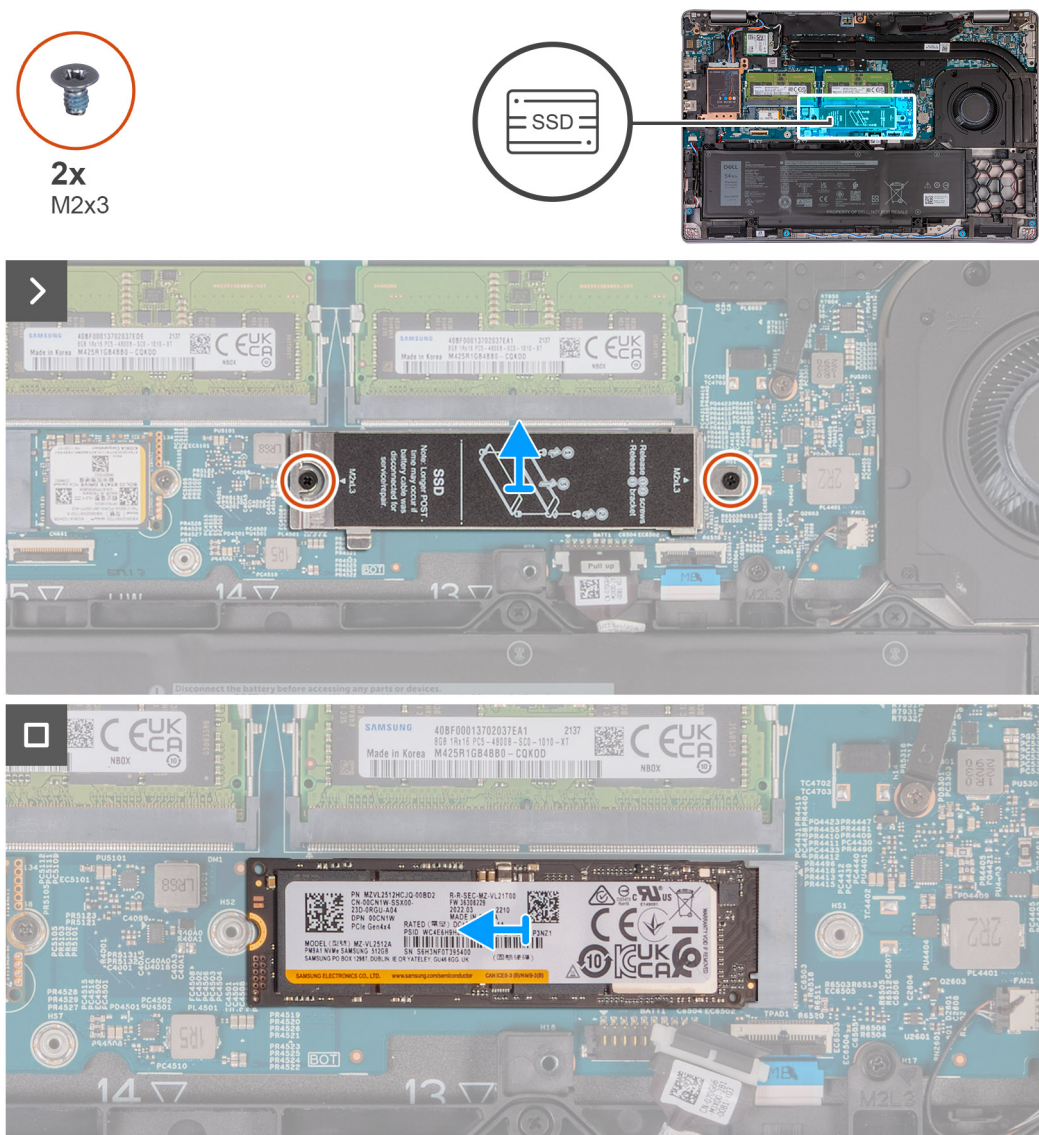

Figure 22. Image: Removing the M.2 2280 solid-state drive from Slot 1

Steps

1. Remove the two screws (M2x3) that secure the solid-state drive thermal shield to the palm-rest assembly.
2. Lift the solid-state drive thermal shield off the palm-rest assembly.
3. Remove the screw (M2x3) that secures the M.2 2280 solid-state drive to the solid-state drive bracket and palm-rest assembly.
4. Slide and lift the M.2 2280 solid-state drive off the solid-state drive slot.
5. Remove the M.2 2280 solid-state drive transfer bracket.

Installing the M.2 2280 solid-state drive in Slot 1

Prerequisites

If you are replacing a component, remove the existing component before performing the installation process.

About this task

The following image(s) indicate the location of the M.2 2280 solid-state drive in Slot 1 and provides a visual representation of the installation procedure.

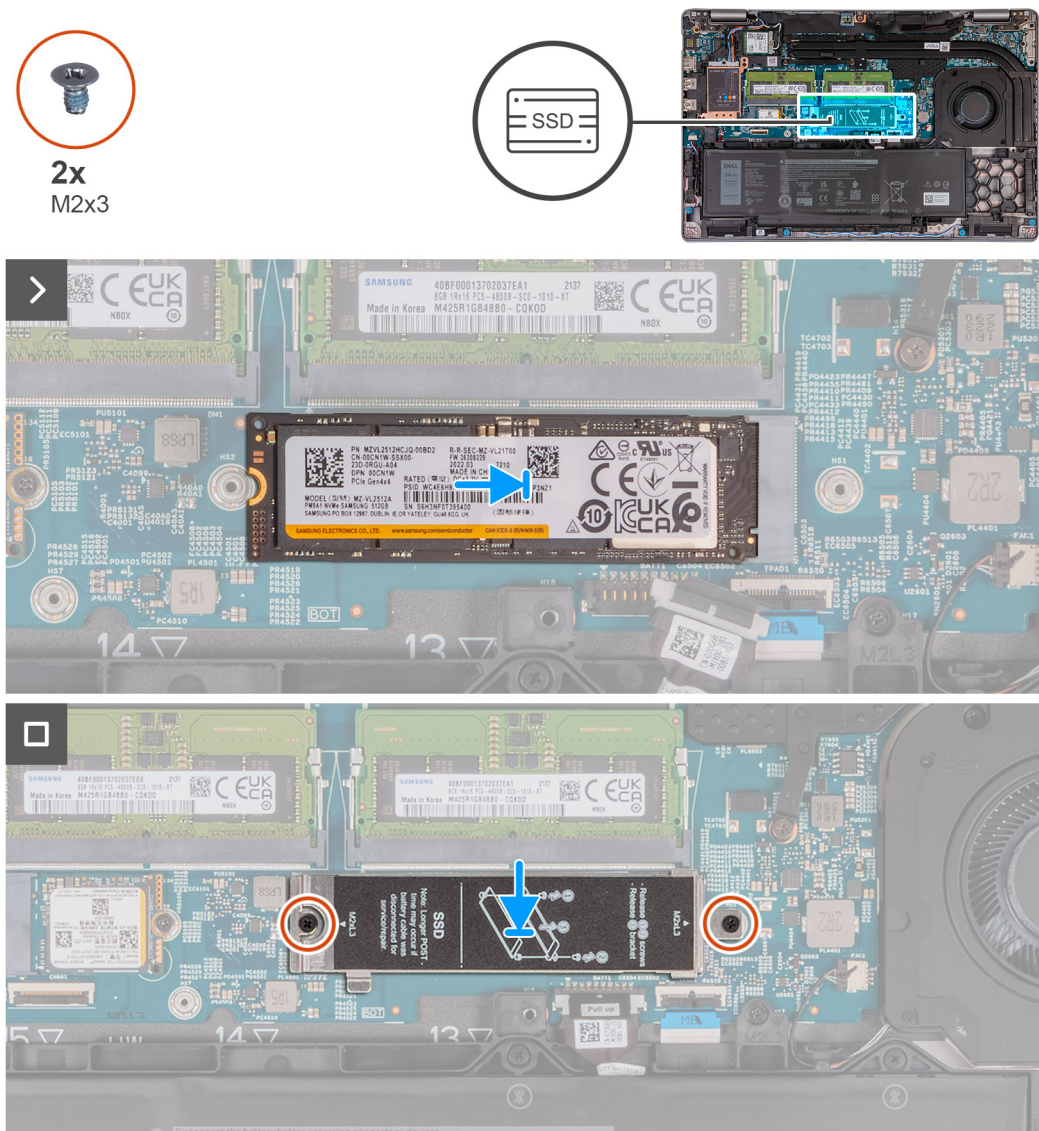

Figure 23. Image: Installing the M.2 2280 solid-state drive in Slot 1

Steps

1. Place the M.2 2280 solid-state drive holder on its slot on the palm-rest assembly.
2. Align the notch on the M.2 2280 solid-state drive with the tab on the M.2 2280 solid-state drive slot.
3. Slide the M.2 2280 solid-state drive into the M.2 2280 solid-state drive slot.
4. Replace the screw (M2x3) that secures the M.2 2280 solid-state drive to the solid-state drive holder and palm-rest assembly.
5. Align the screw holes on the solid-state drive thermal shield with the screw holes on the M.2 2280 solid-state drive and palm-rest assembly.
6. Replace the two screws (M2x3) that secure the solid-state drive thermal shield to the M.2 2280 solid-state drive and palm-rest assembly.

Next steps

1. Install the [base cover](#).
2. Install the [SIM card](#).
3. Follow the procedure in [After working inside your computer](#).

Removing the M.2 2230 solid-state drive from Slot 2

Prerequisites

1. Follow the procedure in [Before working inside your computer](#).
2. Remove the [SIM card](#).
3. Remove the [base cover](#).

About this task

The following image(s) indicate the location of the M.2 2230 solid-state drive in Slot 2 and provides a visual representation of the removal procedure.



1x
M2x3

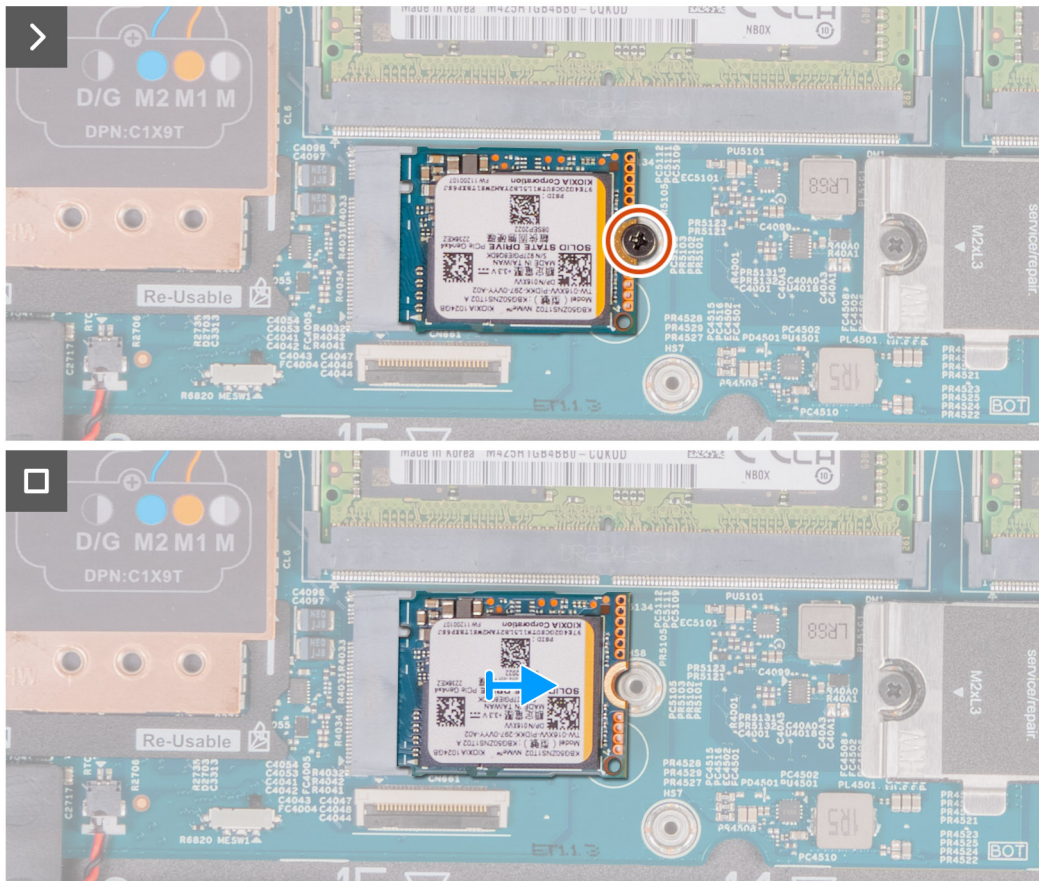
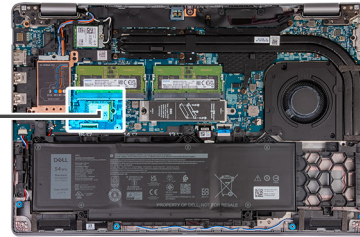

Figure 24. Image: Removing the M.2 2230 solid-state drive from Slot 2

Steps

1. Remove the screw (M2x3) that secures the M.2 2230 solid-state drive to the palm-rest assembly.
2. Slide and lift the M.2 2230 solid-state drive off the solid-state drive slot.

Installing the M.2 2230 solid-state drive in Slot 2

Prerequisites

If you are replacing a component, remove the existing component before performing the installation process.

About this task

The following image(s) indicate the location of the M.2 2230 solid-state drive in Slot 2 and provides a visual representation of the installation procedure.



1x
M2x3

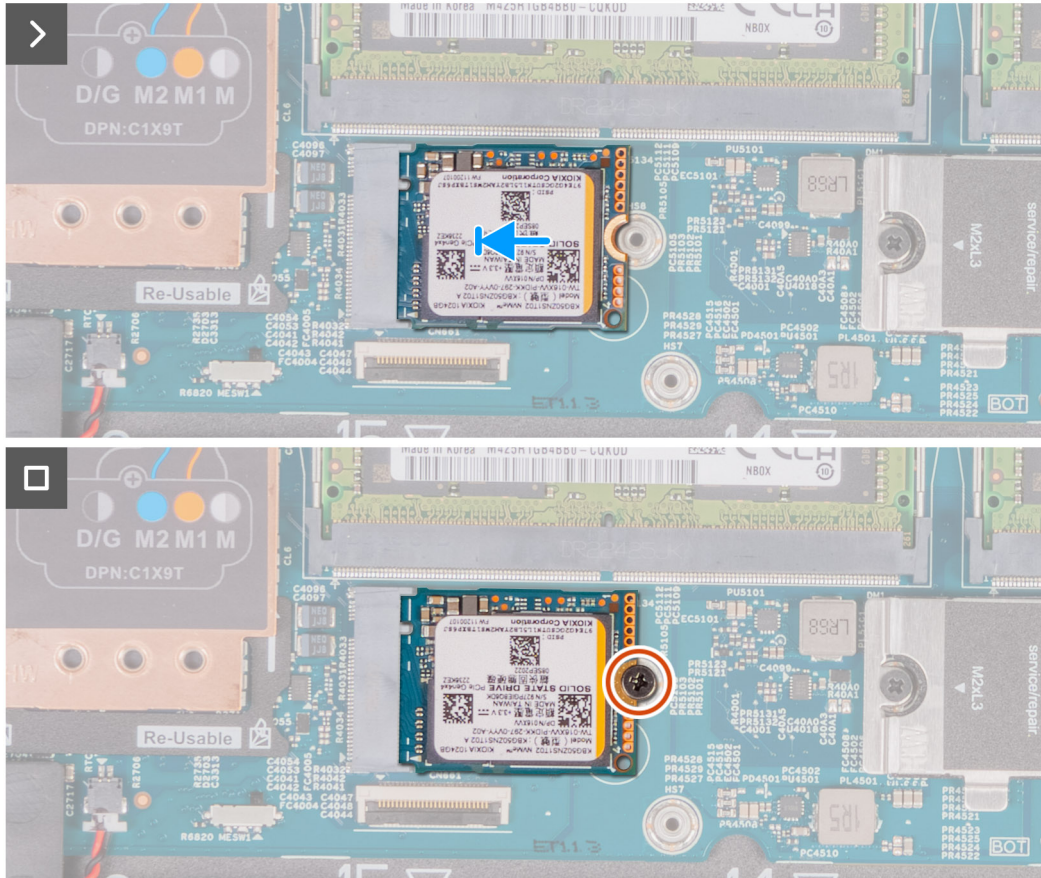
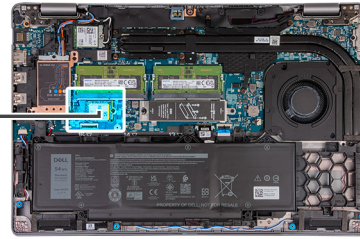

Figure 25. Image: Installing the M.2 2230 solid-state drive from Slot 2

Steps

1. Align the notch on the M.2 2230 solid-state drive with the tab on the M.2 2230 solid-state drive slot.
2. Slide the M.2 2230 solid-state drive into the M.2 2230 solid-state drive slot.
3. Replace the screw (M2x3) that secures the M.2 2230 solid-state drive to the palm-rest assembly.

Next steps

1. Install the [base cover](#).
2. Install the [SIM card](#).
3. Follow the procedure in [After working inside your computer](#).

Fan

Removing the fan

 **CAUTION:** The information in this section is intended for authorized service technicians only.

Prerequisites

1. Follow the procedure in [Before working inside your computer](#).
2. Remove the [SIM card](#).
3. Remove the [base cover](#).

About this task

The following image(s) indicate the location of the fan and provide a visual representation of the removal procedure.

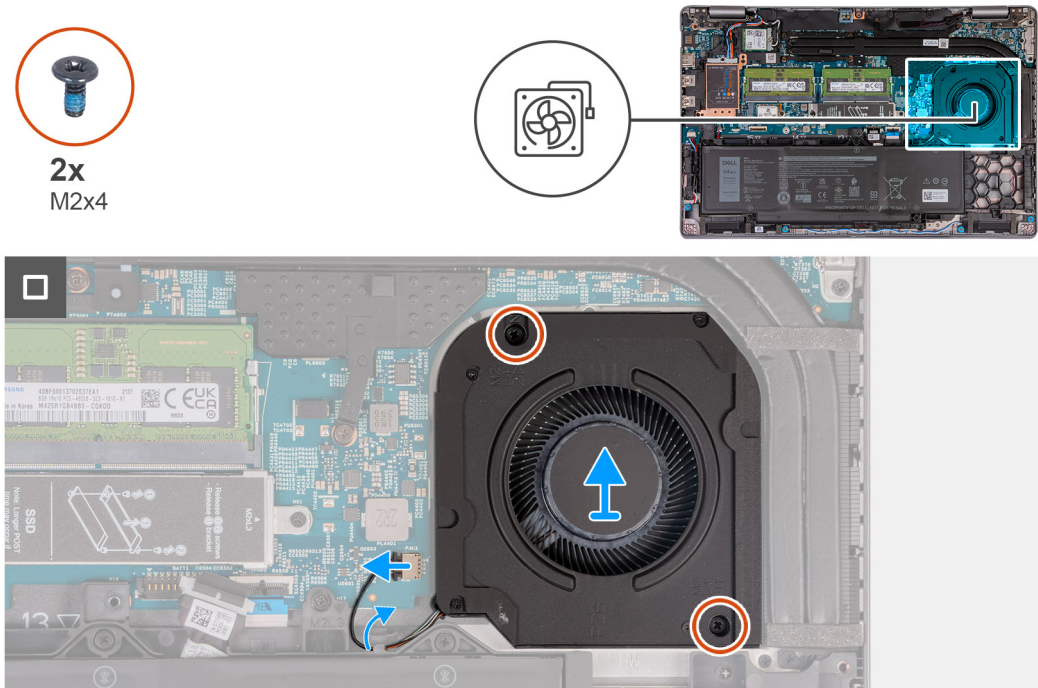

Figure 26. Image: Fan

Steps

1. Disconnect the fan cable from the system board.
2. Remove the fan cable from the routing guides on the palm-rest assembly.
3. Remove the two screws (M2x4) that secure the fan to the palm-rest assembly.
4. Lift the fan off the palm-rest assembly.

Installing the fan

CAUTION: The information in this section is intended for authorized service technicians only.

Prerequisites

If you are replacing a component, remove the existing component before performing the installation process.

About this task

The following image(s) indicate the location of the fan and provide a visual representation of the installation procedure.

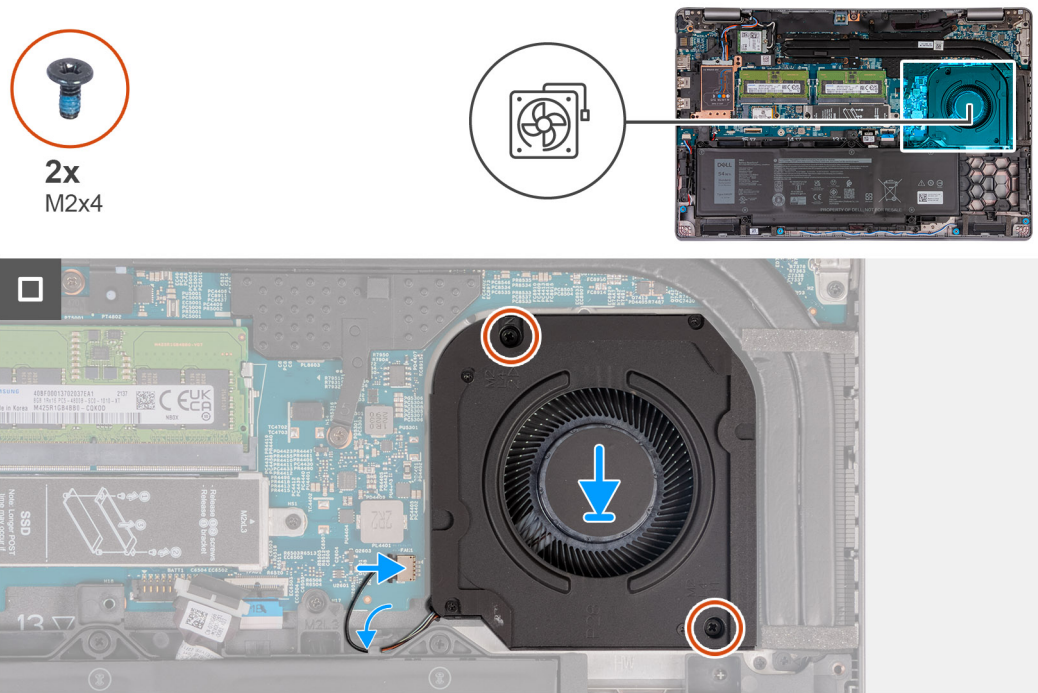

Figure 27. Image: Fan

Steps





1. Align the screw holes on the fan with the screw holes on the palm-rest assembly.
2. Replace the two screws (M2x4) that secure the fan to the palm-rest assembly.
3. Route the fan cable through the routing guides on the palm-rest assembly.
4. Connect the fan cable to the system board.

Next steps

1. Install the [base cover](#).
2. Install the [SIM card](#).
3. Follow the procedure in [After working inside your computer](#).

Removing and installing Field Replaceable Units (FRUs)

The replaceable components in this chapter are Field Replaceable Units (FRUs).

-  **CAUTION:** The information in this removing and installing FRU's section is intended for authorized service technicians only.
-  **CAUTION:** To avoid any potential damage to the component or loss of data, ensure that an authorized service technician replaces the Field Replaceable Units (FRUs).
-  **CAUTION:** Dell Technologies recommends that this set of repairs, if needed, to be conducted by trained technical repair specialists.
-  **CAUTION:** As a reminder, your warranty does not cover damages that may occur during FRU repairs that are not authorized by Dell Technologies.
-  **NOTE:** The images in this document may differ from your computer depending on the configuration you ordered.

Battery

Rechargeable Li-ion battery precautions

-  **CAUTION:**
 - Exercise caution when handling rechargeable Li-ion batteries.
 - Discharge the battery completely before removing it. Disconnect the AC power adapter from the computer and operate the computer solely on battery power—the battery is fully discharged when the computer no longer turns on when the power button is pressed.
 - Do not crush, drop, mutilate, or penetrate the battery with foreign objects.
 - Do not expose the battery to high temperatures, or disassemble battery packs and cells.
 - Do not apply pressure to the surface of the battery.
 - Do not bend the battery.
 - Do not use tools of any kind to pry on or against the battery.
 - Ensure any screws during the servicing of this product are not lost or misplaced, to prevent accidental puncture or damage to the battery and other computer components.
 - If the battery gets stuck inside your computer as a result of swelling, do not try to release it as puncturing, bending, or crushing a rechargeable Li-ion battery can be dangerous. In such an instance, contact Dell technical support for assistance. See [Contact Support at Dell Support Site](#).
 - Always purchase genuine batteries from [Dell Site](#) or authorized Dell partners and resellers.
 - Swollen batteries should not be used and should be replaced and disposed properly. For guidelines on how to handle and replace swollen rechargeable Li-ion batteries, see [Handling swollen rechargeable Li-ion batteries](#).

Removing the battery

-  **CAUTION:** The information in this section is intended for authorized service technicians only.

Prerequisites

1. Follow the procedure in [Before working inside your computer](#).
2. Remove the [SIM card](#).
3. Remove the [base cover](#).

About this task

CAUTION: Removing the battery resets the BIOS setup program's settings to default. It is recommended that you note the BIOS setup program's settings before removing the battery.

The following image(s) indicate the location of the battery and provide a visual representation of the removal procedure.

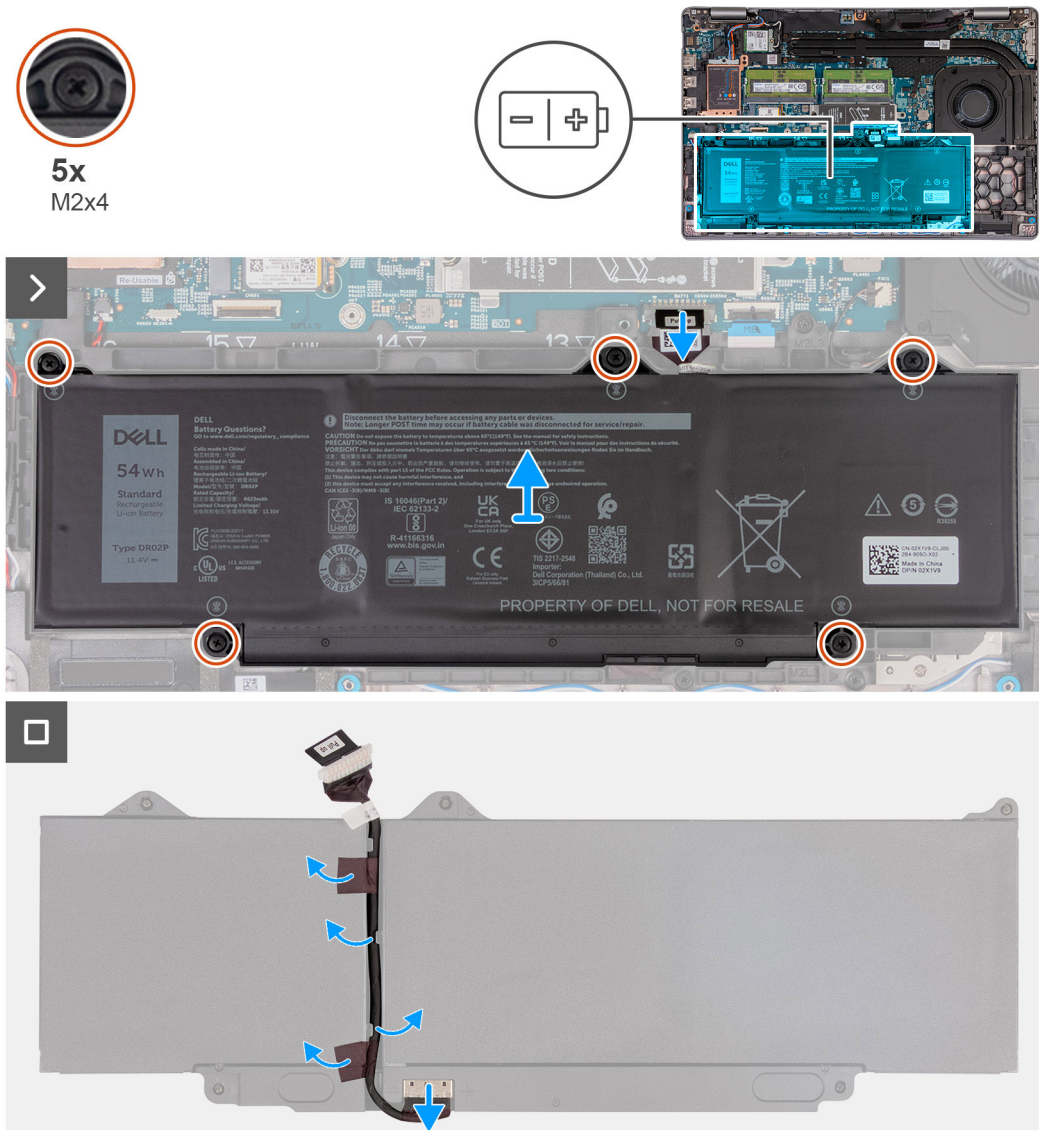

Figure 28. Image: Battery

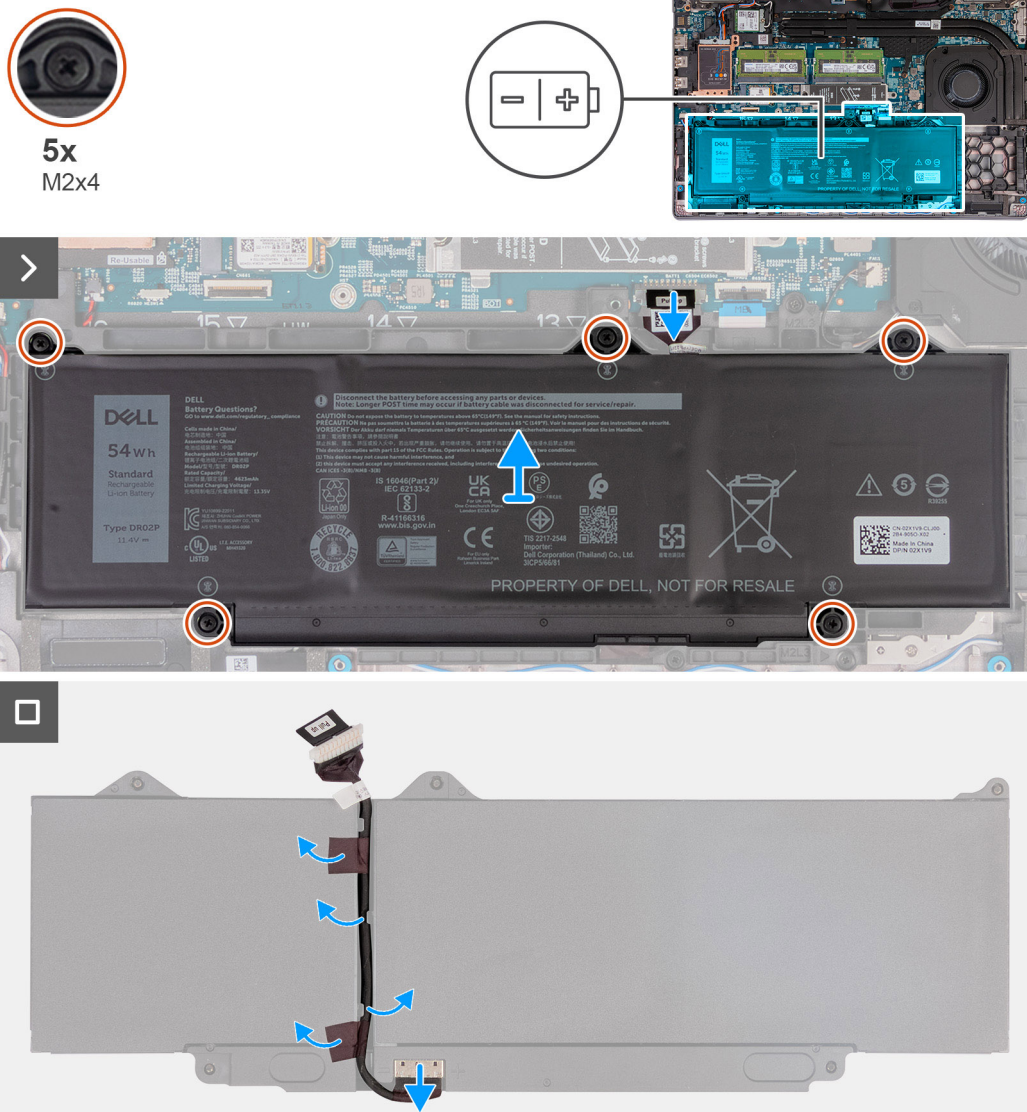

Figure 29. Image: Battery

Steps

1. Disconnect the battery cable from the system board (if not disconnected earlier).
2. Loosen the five captive screws that secure the battery to the palm-rest assembly.
3. Lift the battery off the palm-rest assembly.
4. Flip the battery and peel the tape that adheres the battery cable to the battery.
5. Remove the battery cable from the routing guides on the battery.
6. Disconnect the battery cable from the connector on the battery.
7. Remove the battery cable away from the battery.

Installing the battery

CAUTION: The information in this section is intended for authorized service technicians only.

Prerequisites

If you are replacing a component, remove the existing component before performing the installation process.

About this task

The following image(s) indicate the location of the battery and provide a visual representation of the installation procedure.

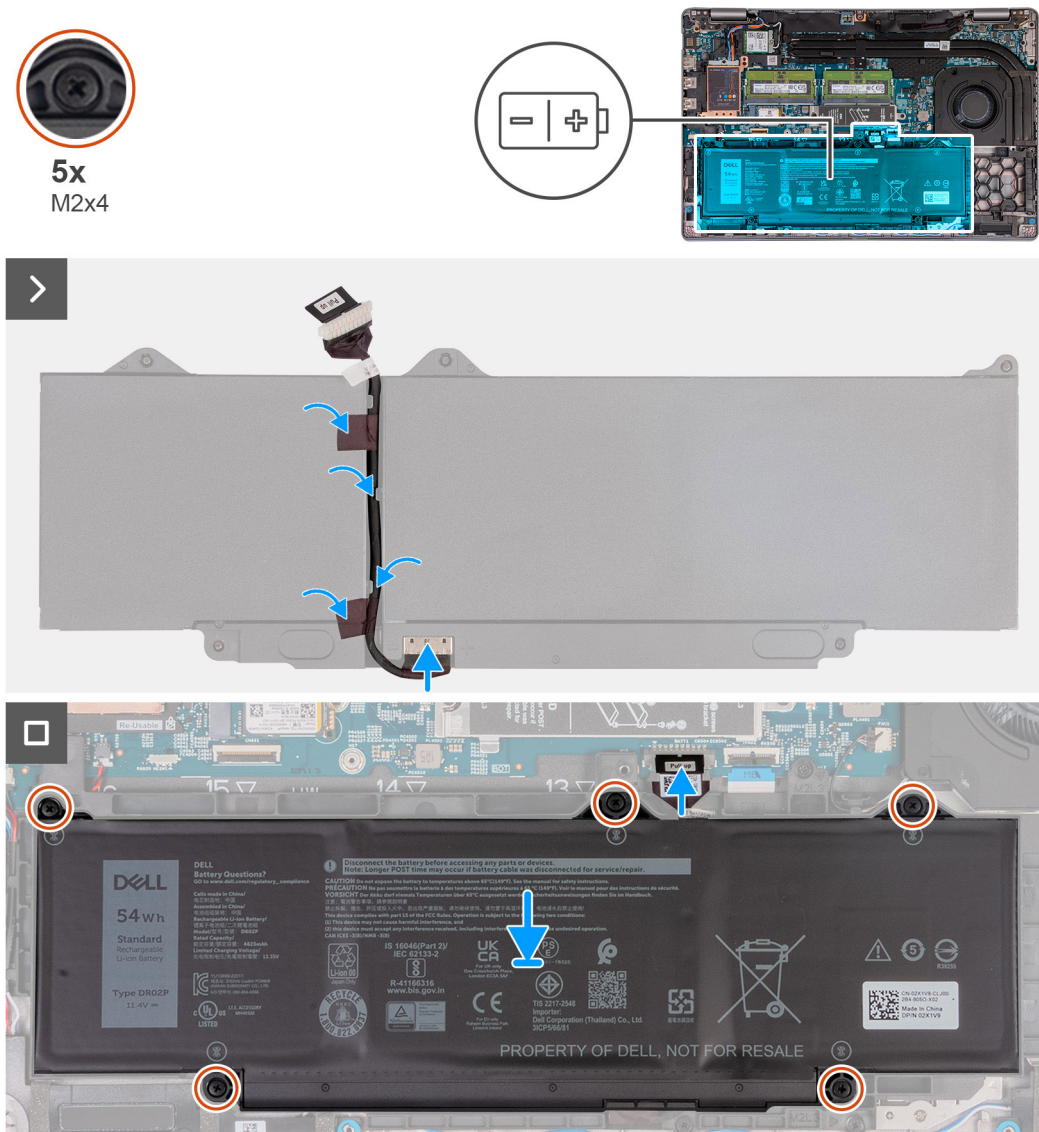

Figure 30. Image: Battery

Steps

1. Align and route the battery cable through the routing guides on the battery.
2. Adhere the tape that secures the battery cable to the battery.
3. Connect the battery cable to the connector on the battery.
4. Flip the battery.
5. Using the alignment posts, place the battery on the palm-rest assembly.
6. Align the screw holes on the battery with the screw holes on the palm-rest assembly.
7. Tighten the five captive screws that secure the battery to the palm-rest assembly.
8. Connect the battery cable to the system board.

Next steps

1. Install the [base cover](#).
2. Install the [SIM card](#).
3. Follow the procedure in [After working inside your computer](#).

Assembly-inner frame

Removing the assembly-inner frame

CAUTION: The information in this section is intended for authorized service technicians only.

Prerequisites

1. Follow the procedure in [Before working inside your computer](#).
2. Remove the [SIM card](#).
3. Remove the [base cover](#).
4. Remove the [battery](#).
5. Remove the [4G WWAN card](#) or [5G WWAN card](#), as applicable.
6. Remove the [WLAN card](#).

About this task

The following images indicate the location of the assembly-inner frame and provide a visual representation of the removal procedure.



12x
M2x3

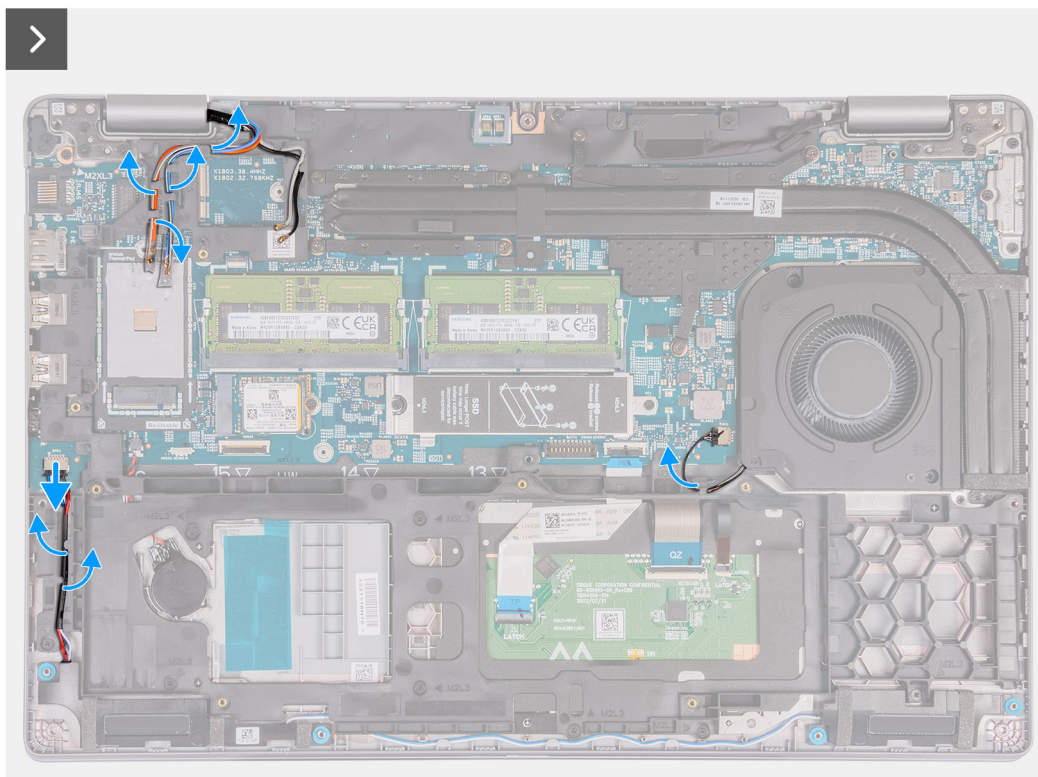
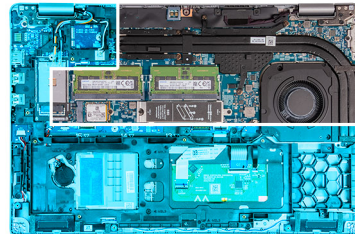

Figure 31. Image: Assembly-inner frame

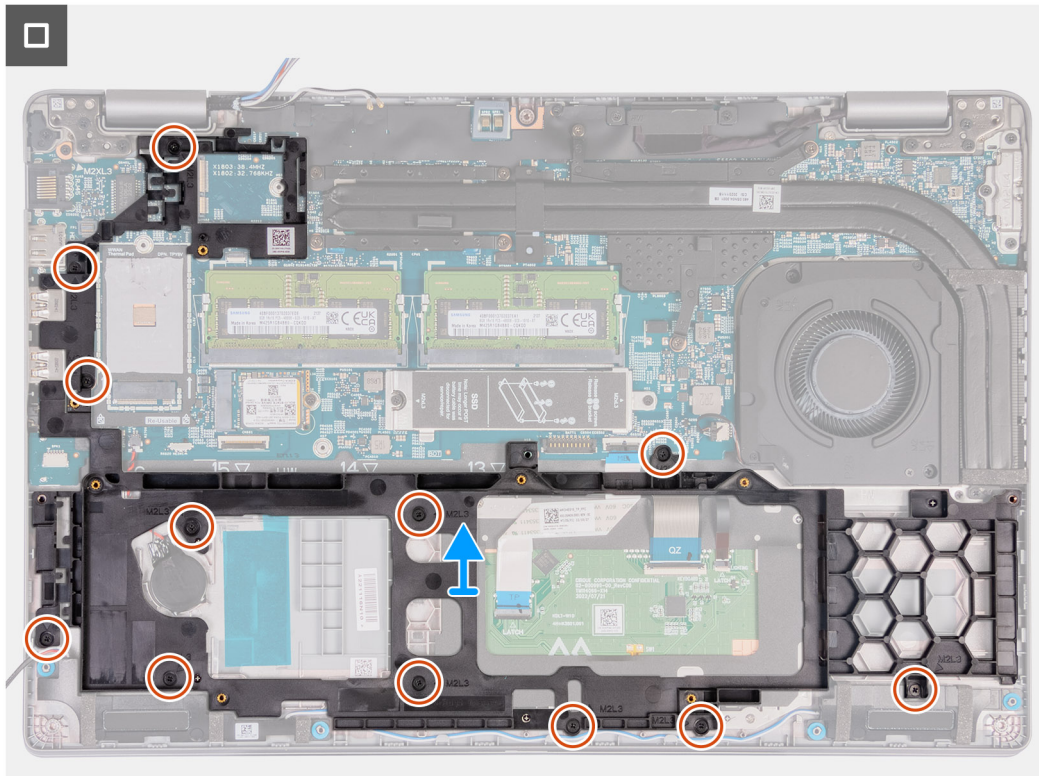

Figure 32. Image: Inner frame removal

Steps

1. Remove the antenna cables from the routing guides on the palm-rest assembly.
2. Disconnect the speaker cable from the system board.
3. Remove the speaker cables from the routing guides on the palm-rest assembly.
4. Remove the fan cable from the routing guides on the palm-rest assembly.
5. Remove the twelve screws (M2x3) that secure the assembly-inner frame to the palm-rest assembly.
6. Remove the thirteen screws (M2x3) that secure the assembly-inner frame to the palm-rest assembly.
7. Remove the assembly-inner frame off the palm-rest assembly.

Installing the assembly-inner frame

CAUTION: The information in this section is intended for authorized service technicians only.

Prerequisites

If you are replacing a component, remove the existing component before performing the installation process.

About this task

The following images indicate the location of the assembly-inner frame and provide a visual representation of the installation procedure.



12x
M2x3

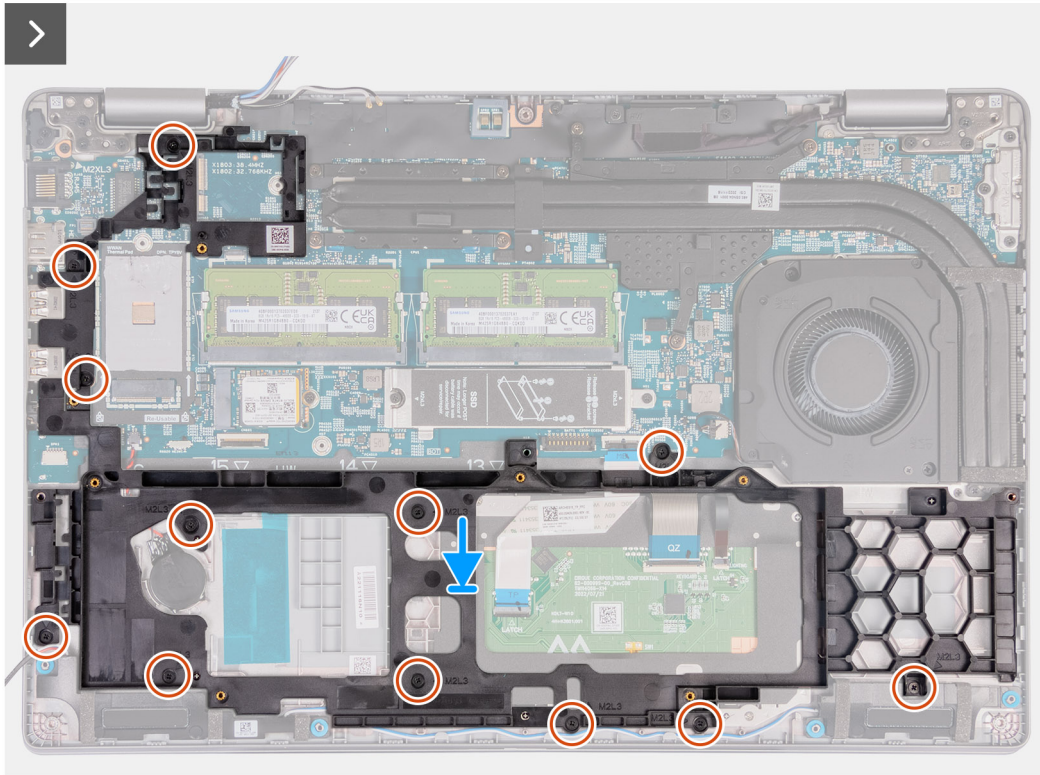
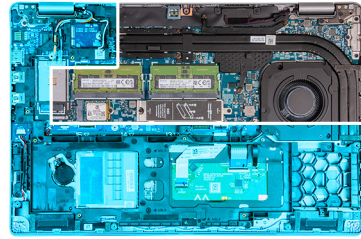

Figure 33. Image: Assembly-inner frame

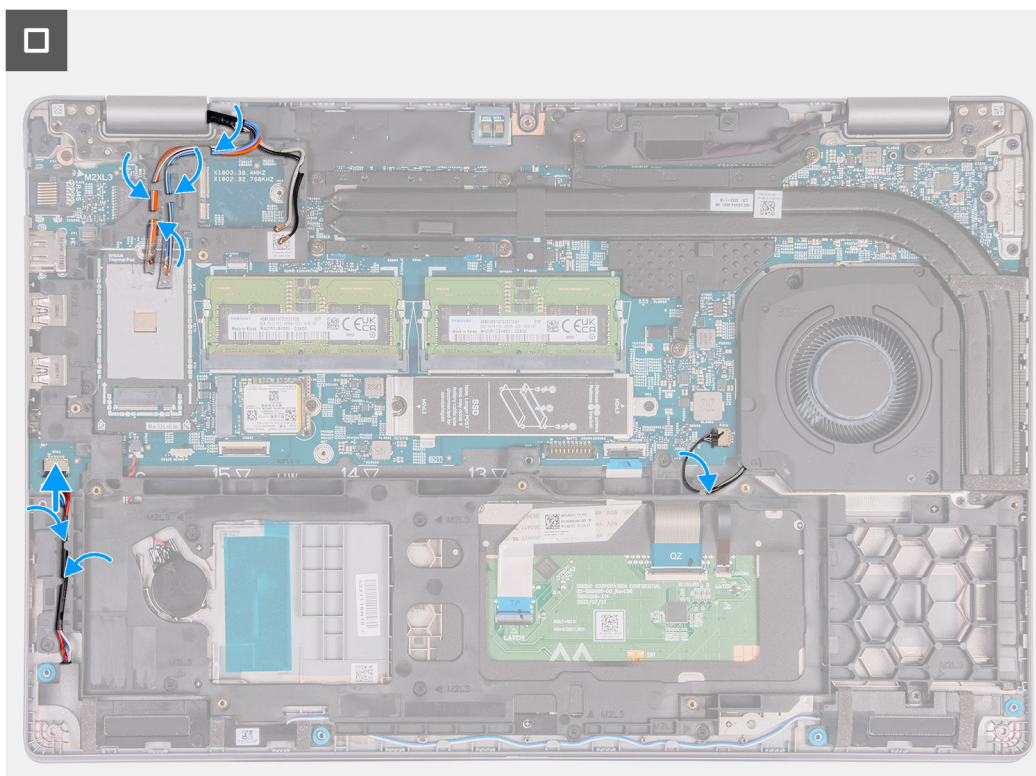

Figure 34. Image: Assembly-inner frame

Figure 35. Image: Assembly-inner frame

Figure 36. Image: Assembly-inner frame

Steps

1. Align the screw holes on the assembly-inner frame with the screw holes on the system board and the palm-rest assembly.
2. Replace the twelve screws (M2x3) that secure the assembly-inner frame to the palm-rest assembly.
3. Connect the speaker cable to the system board.
4. Route the speaker cables through the routing guides on the palm-rest assembly.
5. Route the fan cable through the routing guides on the palm-rest assembly.
6. Route the antenna cables through the routing guides on the palm-rest assembly.

Next steps

1. Install the [WLAN card](#).
2. Install the [4G WWAN card](#) or [5G WWAN card](#), as applicable.
3. Install the [battery](#).
4. Install the [base cover](#).
5. Install the [SIM card](#).
6. Follow the procedure in [After working inside your computer](#).

Speakers

Removing the speakers

 **CAUTION:** The information in this section is intended for authorized service technicians only.

Prerequisites

1. Follow the procedure in [Before working inside your computer](#).
2. Remove the [SIM card](#).
3. Remove the [base cover](#).
4. Remove the [4G WWAN card](#) or [5G WWAN card](#), as applicable.
5. Remove the [WLAN card](#).
6. Remove the [assembly-inner frame](#).

About this task

The following images indicate the location of the speakers and provide a visual representation of the removal procedure.

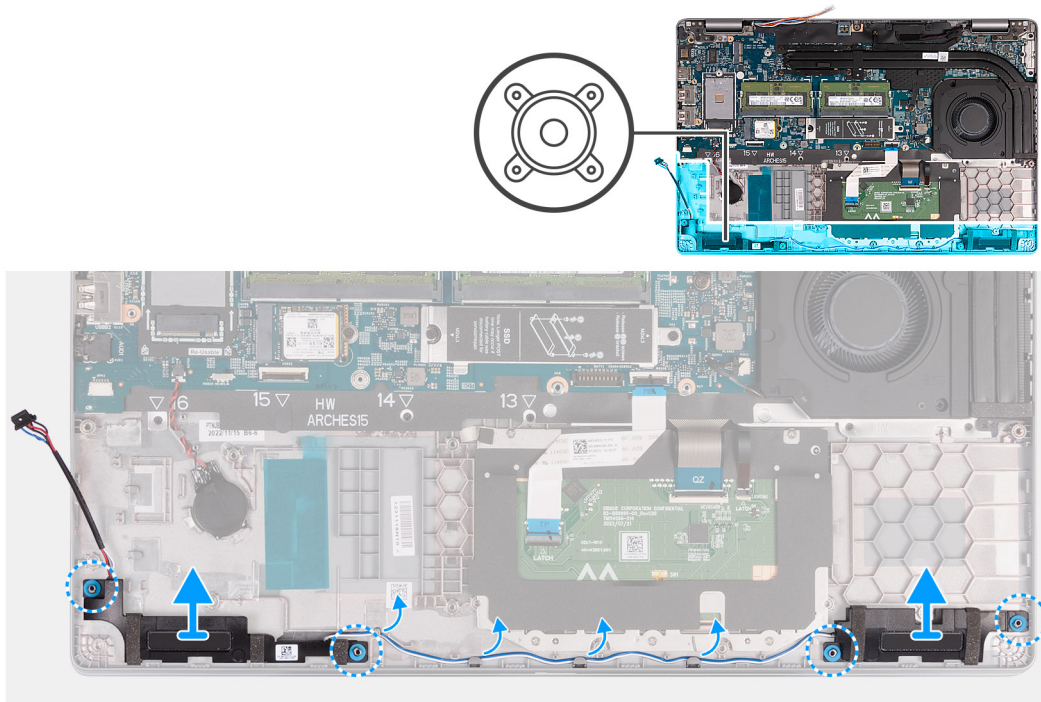

Figure 37. Image: Speakers

Steps

1. Disconnect the speaker cable from the system board.
2. Remove the speaker cables from the routing guides on the palm-rest assembly.
3. Lift the right and left speakers, along with its cable, off the palm-rest assembly.

Installing the speakers

CAUTION: The information in this section is intended for authorized service technicians only.

Prerequisites

If you are replacing a component, remove the existing component before performing the installation process.

About this task

The following images indicate the location of the speakers and provide a visual representation of the installation procedure.

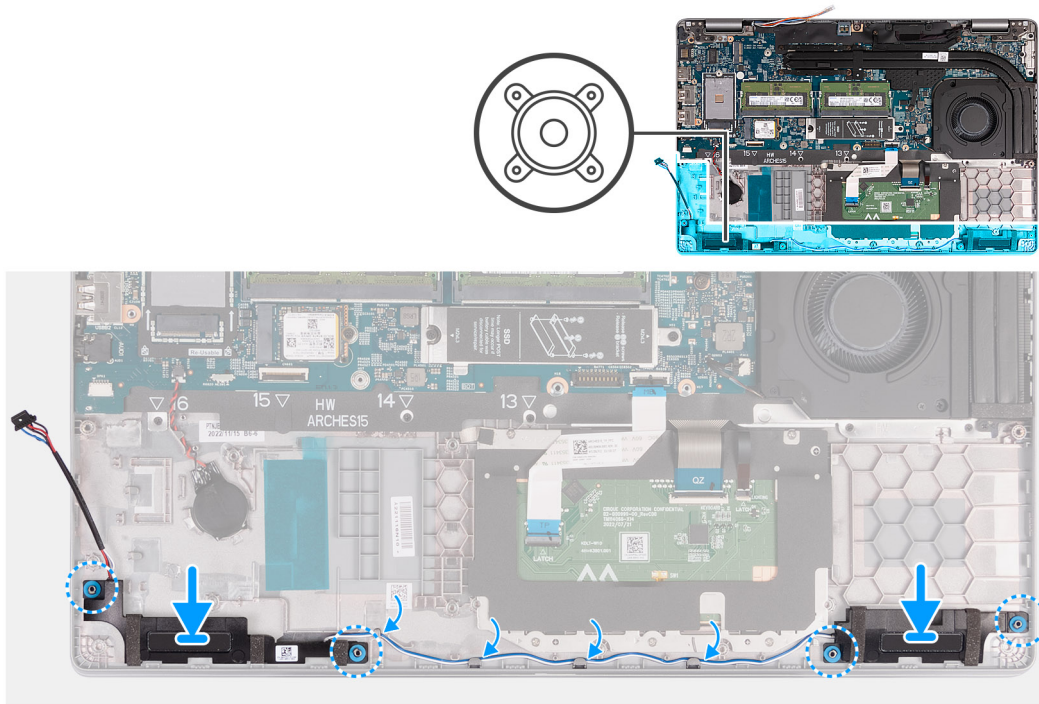

Figure 38. Image: Speakers

Steps

1. Using the alignment posts, place the left and right speakers into their slots on the palm-rest assembly.
2. Route the speaker cable through the routing guides on the palm-rest assembly.
3. Connect the speaker cable to the system board.

Next steps

1. Install the [assembly-inner frame](#).
2. Install the [WLAN card](#).
3. Install the [4G WWAN card](#) or [5G WWAN card](#), as applicable.
4. Install the [base cover](#).
5. Install the [SIM card](#).
6. Follow the procedure in [After working inside your computer](#).

Coin-cell battery

Removing the coin-cell battery

Prerequisites

1. Follow the procedure in [Before working inside your computer](#).
2. Remove the [SIM card](#).
3. Remove the [base cover](#).
4. Remove the [battery](#).
5. Remove the [assembly-inner frame](#).

About this task

The following image(s) indicate the location of the coin-cell battery and provides a visual representation of the removal procedure.

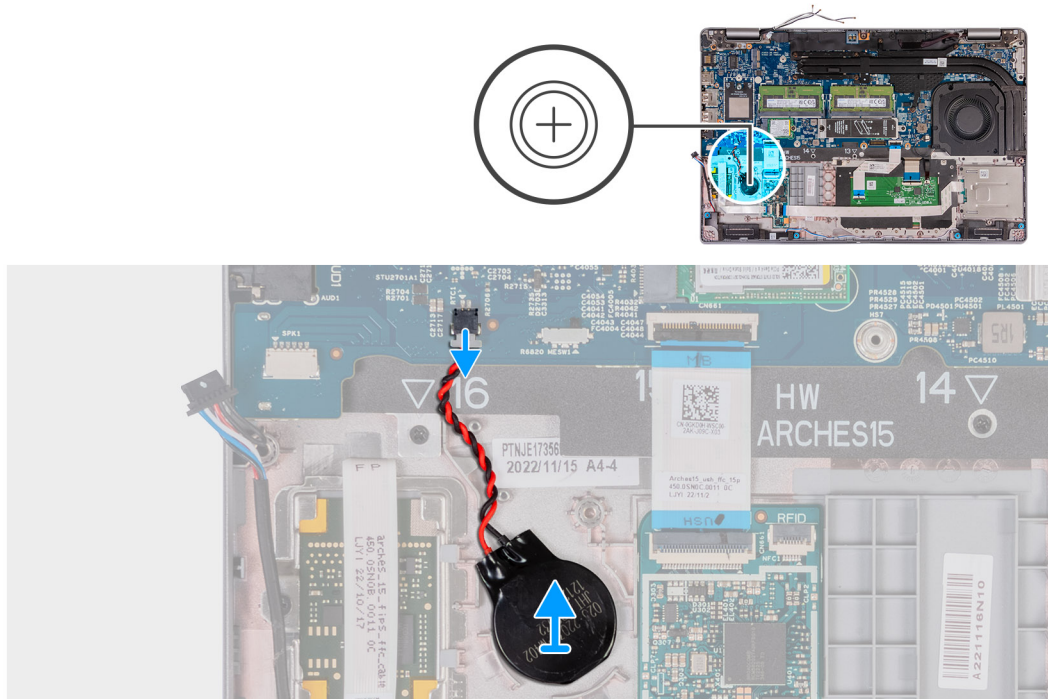

Figure 39. Image: Coin-cell battery

Steps

1. Disconnect the coin-cell battery cable from the system board.
2. Peel the coin-cell battery, along with its cable, off the palm-rest assembly.

Installing the coin-cell battery

Prerequisites

If you are replacing a component, remove the existing component before performing the installation process.

About this task

The following image(s) indicate the location of the coin-cell battery and provides a visual representation of the installation procedure.

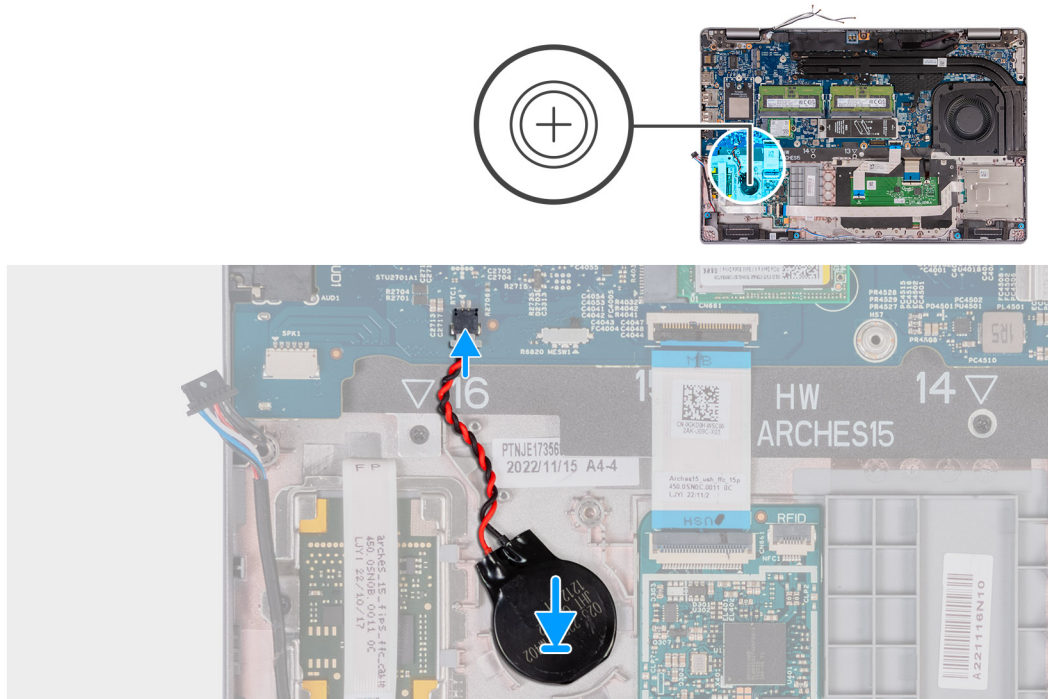

Figure 40. Image: Coin-cell battery

Steps

1. Adhere the coin-cell battery on to the coin-cell battery slot on the palm-rest assembly.
2. Connect the coin-cell battery cable to the connector on the system board.

Next steps

1. Install the [assembly-inner frame](#).
2. Install the [battery](#).
3. Install the [base cover](#).
4. Install the [SIM card](#).
5. Follow the procedure in [After working inside your computer](#).

Heat sink

Removing the heat sink (Discrete GPU)

⚠ CAUTION: The information in this section is intended for authorized service technicians only.

Prerequisites

1. Follow the procedure in [Before working inside your computer](#).
2. Remove the [SIM card](#).
3. Remove the [base cover](#).

About this task

- i NOTE:** The heat sink may become hot during normal operation. Allow sufficient time for the heat sink to cool before you touch it.
- i NOTE:** For maximum cooling of the processor, do not touch the heat transfer areas on the heat sink. The oils in your skin can reduce the heat transfer capability of the thermal grease.

The following images indicate the location of the heat sink and provide a visual representation of the removal procedure.

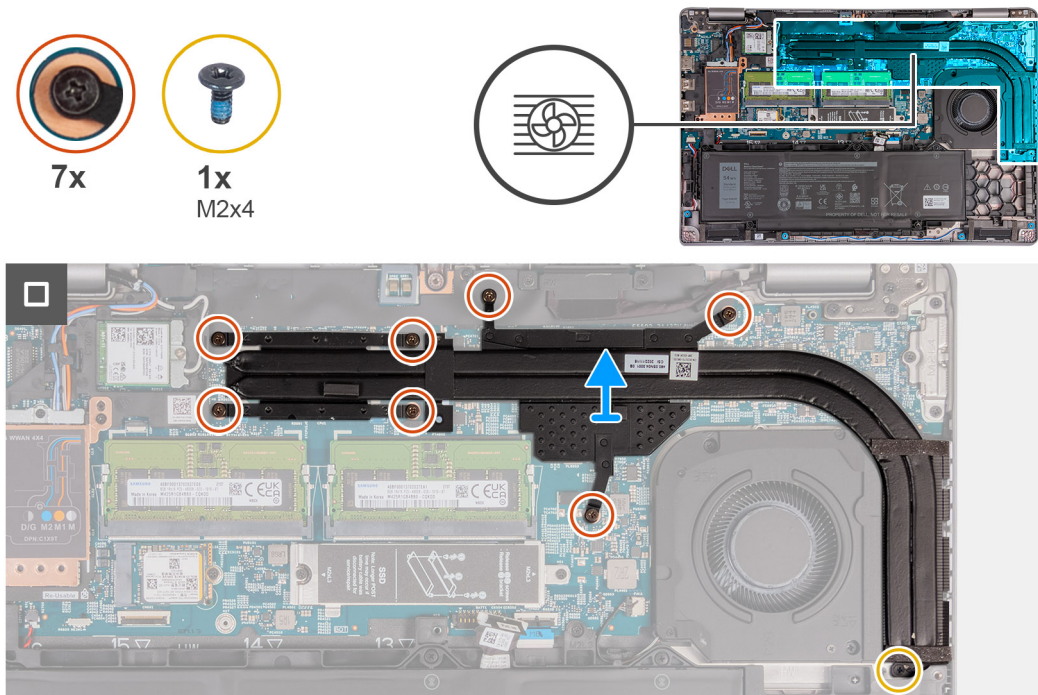

Figure 41. Image: Heatsink

Steps

1. Loosen the seven captive screws that secure the heat sink to the system board.

i | **NOTE:** Loosen the captive screws in the reverse sequential order mentioned on the heat sink [7 > 6 > 5 > 4 > 3 > 2 > 1].

i | **NOTE:** The number of screws varies depending on the configuration ordered.

2. Remove the screw (M2x4) that secures the heat sink to the system board.

3. Lift the heat sink from the system board.

Installing the heat sink (Discrete GPU)

⚠ CAUTION: The information in this section is intended for authorized service technicians only.

Prerequisites

If you are replacing a component, remove the existing component before performing the installation process.

About this task

i | **NOTE:** If either the system board or the heat sink is replaced, use the thermal grease provided in the kit to ensure that thermal conductivity is achieved.

The following images indicate the location of the heat sink and provide a visual representation of the installation procedure.

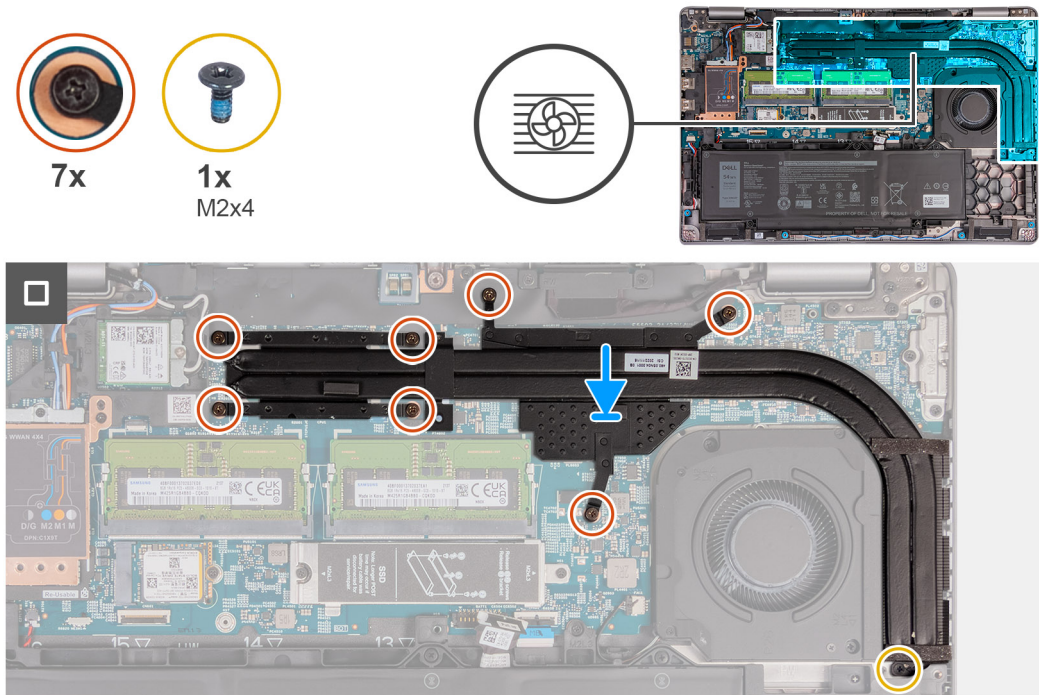

Figure 42. Image: Heatsink

Steps

1. Place the heat sink on the system board.
2. Tighten the seven captive screws that secure the heat sink to the system board.
 - i** **NOTE:** Tighten the captive screws in the sequential order mentioned on the heat sink [1 > 2 > 3 > 4 > 5 > 6 > 7].
 - i** **NOTE:** The number of screws varies depending on the configuration ordered.
3. Replace the screw (M2x4) that secures the heat sink to the system board.

Next steps

1. Install the [base cover](#).
2. Install the [SIM card](#).
3. Follow the procedure in [After working inside your computer](#).

Removing the heat sink (Integrated GPU)

⚠ CAUTION: The information in this section is intended for authorized service technicians only.

Prerequisites

1. Follow the procedure in [Before working inside your computer](#).
2. Remove the [SIM card](#).
3. Remove the [base cover](#).

About this task

- i** **NOTE:** The heat sink may become hot during normal operation. Allow sufficient time for the heat sink to cool before you touch it.
- i** **NOTE:** For maximum cooling of the processor, do not touch the heat transfer areas on the heat sink. The oils in your skin can reduce the heat transfer capability of the thermal grease.

The following images indicate the location of the heat sink and provide a visual representation of the removal procedure.

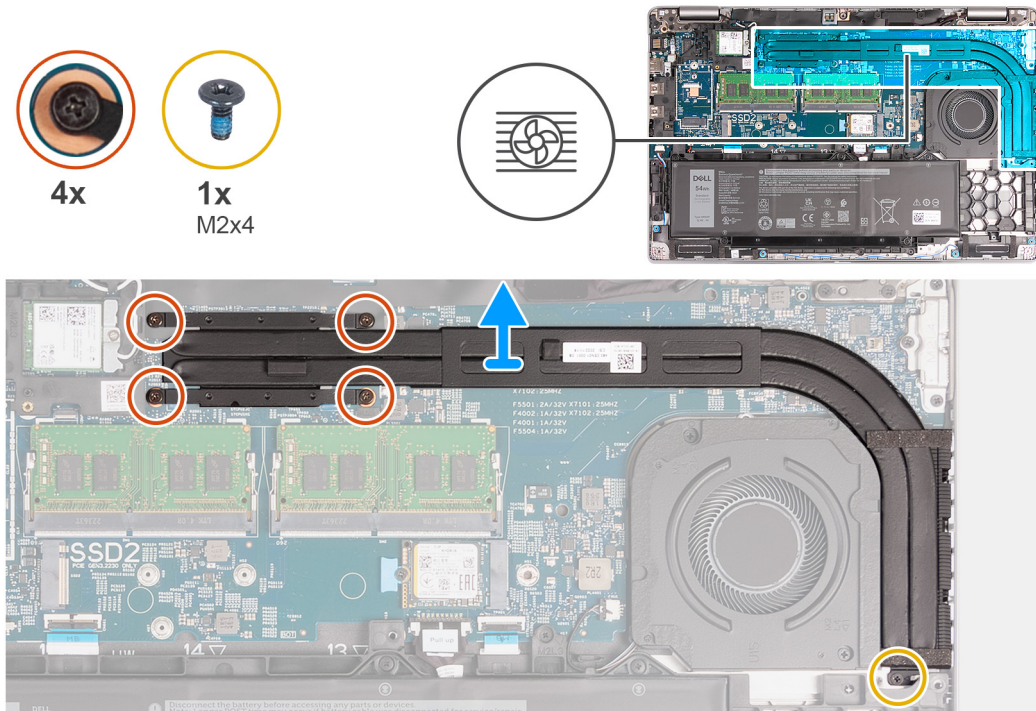

Figure 43. Image: Heatsink

Steps

1. Loosen the four captive screws that secure the heat sink to the system board.
 - i** **NOTE:** Loosen the captive screws in the reverse sequential order mentioned on the heat sink [4 > 3 > 2 > 1].
 - i** **NOTE:** The number of screws varies depending on the configuration ordered.
2. Remove the screw (M2x4) that secures the heat sink to the system board.
3. Lift the heat sink from the system board.

Installing the heat sink (Integrated GPU)

⚠ CAUTION: The information in this section is intended for authorized service technicians only.

Prerequisites

If you are replacing a component, remove the existing component before performing the installation process.

About this task

i **NOTE:** If either the system board or the heat sink is replaced, use the thermal grease provided in the kit to ensure that thermal conductivity is achieved.

The following images indicate the location of the heat sink and provide a visual representation of the installation procedure.

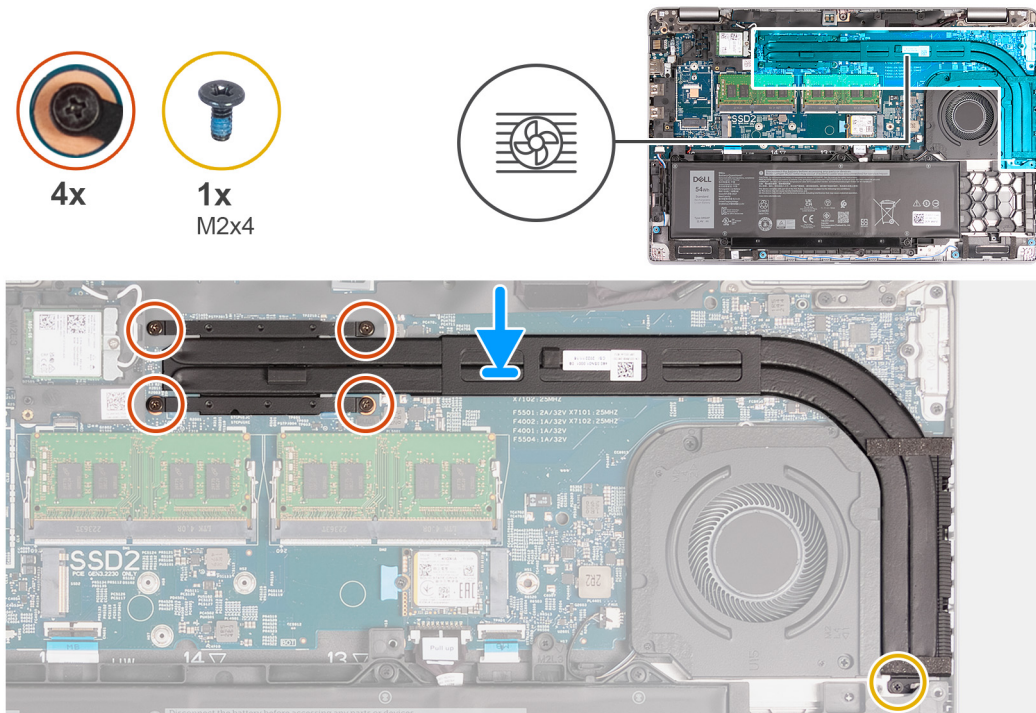

Figure 44. Image: Heatsink

Steps

1. Place the heat sink on the system board.
2. Tighten the four captive screws that secure the heat sink to the system board.
 - i** **NOTE:** Tighten the captive screws in the sequential order mentioned on the heat sink [1 > 2 > 3 > 4].
 - i** **NOTE:** The number of screws varies depending on the configuration ordered.
3. Replace the screw (M2x4) that secures the heat sink to the system board.

Next steps

1. Install the [base cover](#).
2. Install the [SIM card](#).
3. Follow the procedure in [After working inside your computer](#).

System board

Removing the system board

⚠ CAUTION: The information in this section is intended for authorized service technicians only.

Prerequisites

1. Follow the procedure in [Before working inside your computer](#).
2. Remove the [SIM card](#).
3. Remove the [base cover](#).
4. Remove the [4G WWAN card](#) or [5G WWAN card](#), as applicable.
5. Remove the [WLAN card](#).
6. Remove the [memory modules](#).
7. Remove the [M.2 2230](#) or [M.2 2280](#) solid-state drive from Slot 1, as applicable.

8. Remove the [M.2 2230 solid-state drive from Slot 2](#), if applicable.
9. Remove the [heat sink \(discrete GPU\)](#) or [heat sink \(integrated GPU\)](#), as applicable.
10. Remove the [battery](#).
11. Remove the [assembly-inner frame](#).

About this task

The following images indicate the system board connectors.

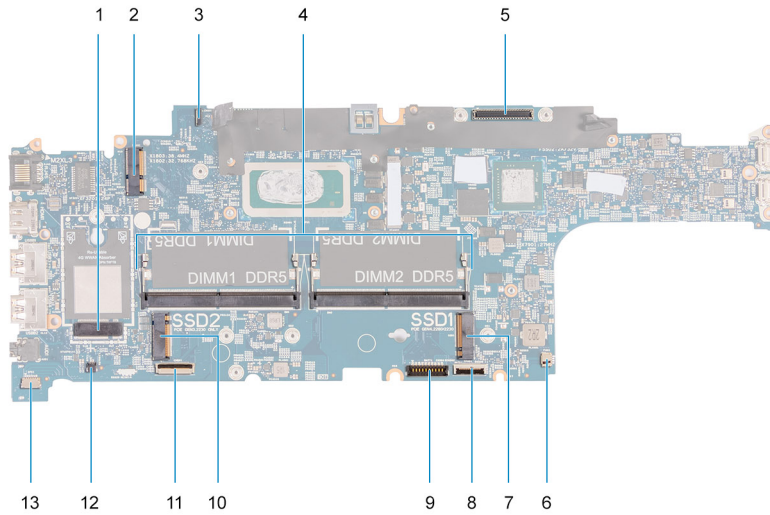

Figure 45. Image: System board connectors

- | | |
|---------------------------------|---------------------------------------|
| 1. WWAN-card connector | 2. WLAN-card connector |
| 3. Sensor board-cable connector | 4. Memory modules |
| 5. Display-cable connector | 6. System-fan connector |
| 7. Solid-state drive Slot 1 | 8. Touchpad-cable connector |
| 9. Battery-cable connector | 10. Solid-state drive Slot 2 |
| 11. USB-cable connector | 12. Coin-cell battery cable connector |
| 13. Speaker-cable connector | |

The following images indicate the location of the system board and provide a visual representation of the removal procedure.

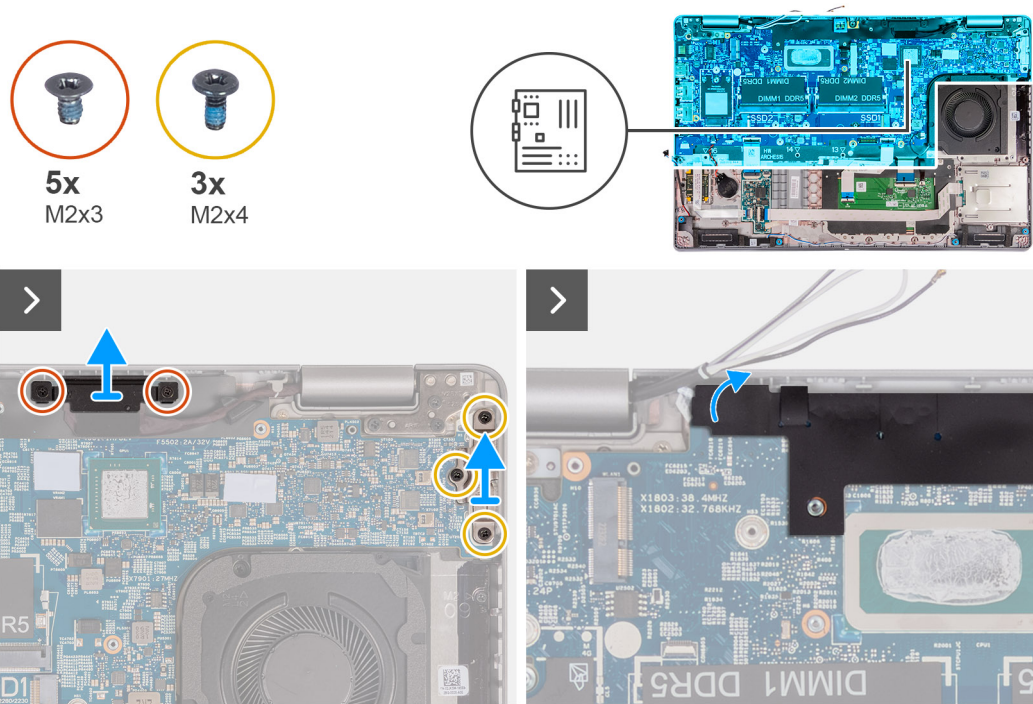

Figure 46. Image: System board connectors

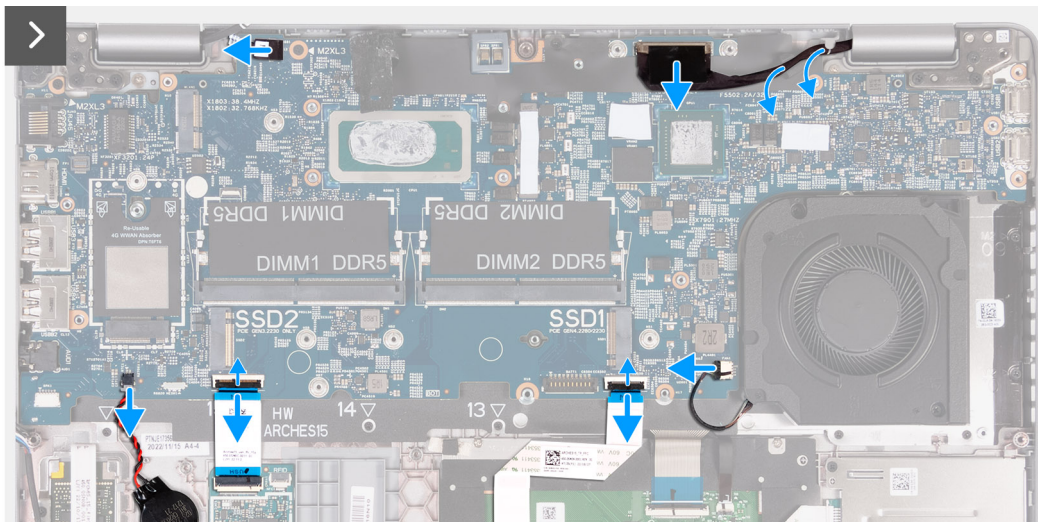

Figure 47. Image: System board connectors

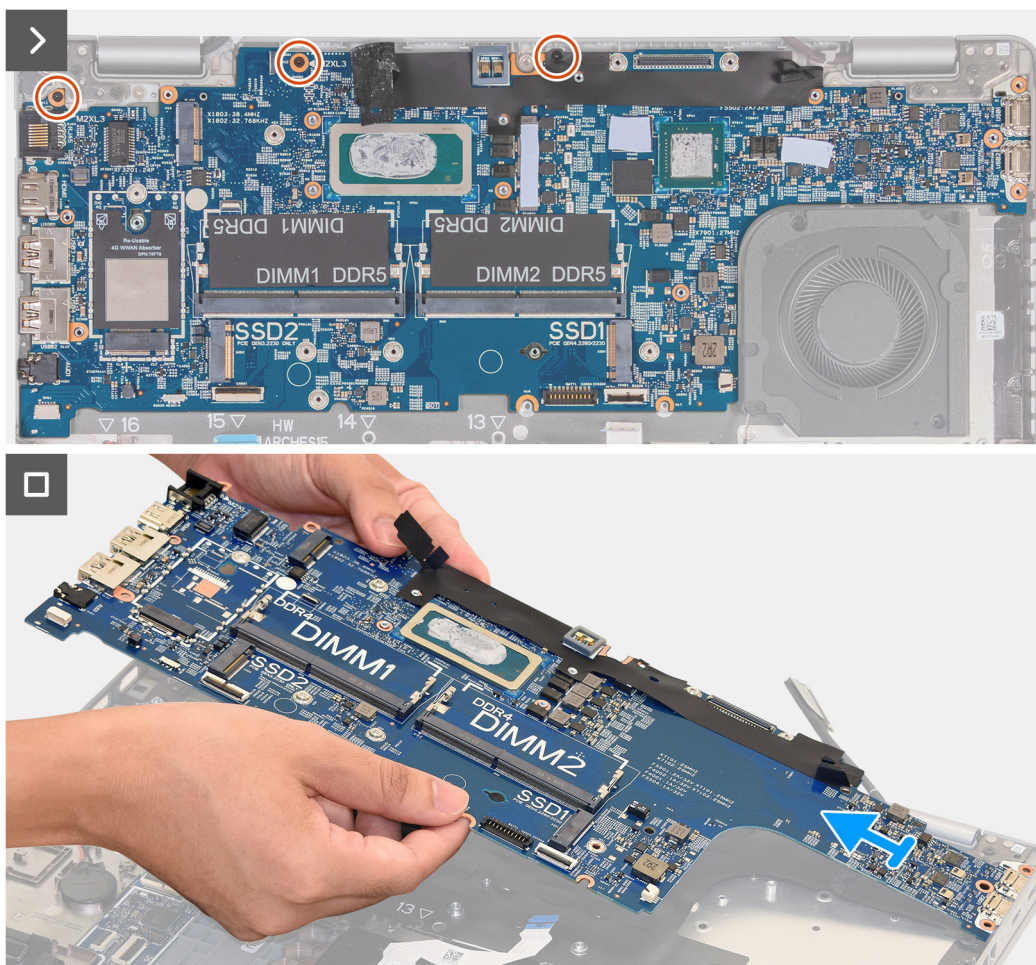

Figure 48. Image: System board connectors

Steps

1. Remove the two screws (M2x3) that secure the display-cable bracket to the palm-rest assembly.
2. Lift the display-cable bracket off the palm-rest assembly.
3. Remove the three screws (M2x4) that secure the Type-C bracket to the palm-rest assembly.
4. Lift the Type-C bracket off the palm-rest assembly.
5. Lift the black flap near the antenna cables and uncover the sensor board-cable.
6. Disconnect the sensor board-cable from the connector on the system board.
7. Disconnect the display cable from the connector on the system board.
8. Remove the display cable from the routing guides on the system board.
9. Disconnect the fan cable from the connector on the system board.
10. Open the latch and disconnect the touchpad cable from the connector on the system board.
11. Open the latch and disconnect the USH cable from the USH module.
12. Disconnect the coin-cell battery cable from the connector on the system board.
13. Remove the three screws (M2x3) that secure the system board to the palm-rest assembly.

CAUTION: Ensure to remove the SIM card tray and USB Type-C bracket to avoid any possible damage to the components.

14. Lift the system board off the palm-rest assembly.

Installing the system board

CAUTION: The information in this section is intended for authorized service technicians only.

Prerequisites

If you are replacing a component, remove the existing component before performing the installation process.

About this task

The following images indicate the system board connectors.

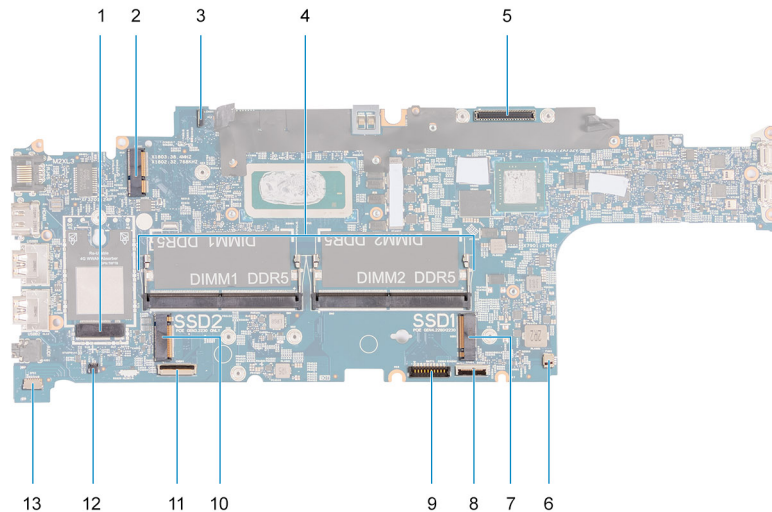

Figure 49. Image: System board connectors

- | | |
|---------------------------------|---------------------------------------|
| 1. WWAN-card connector | 2. WLAN-card connector |
| 3. Sensor board-cable connector | 4. Memory modules |
| 5. Display-cable connector | 6. System-fan connector |
| 7. Solid-state drive Slot 1 | 8. Touchpad-cable connector |
| 9. Battery-cable connector | 10. Solid-state drive Slot 2 |
| 11. USH-cable connector | 12. Coin-cell battery cable connector |
| 13. Speaker-cable connector | |

The following images indicate the location of the system board and provide a visual representation of the installation procedure.

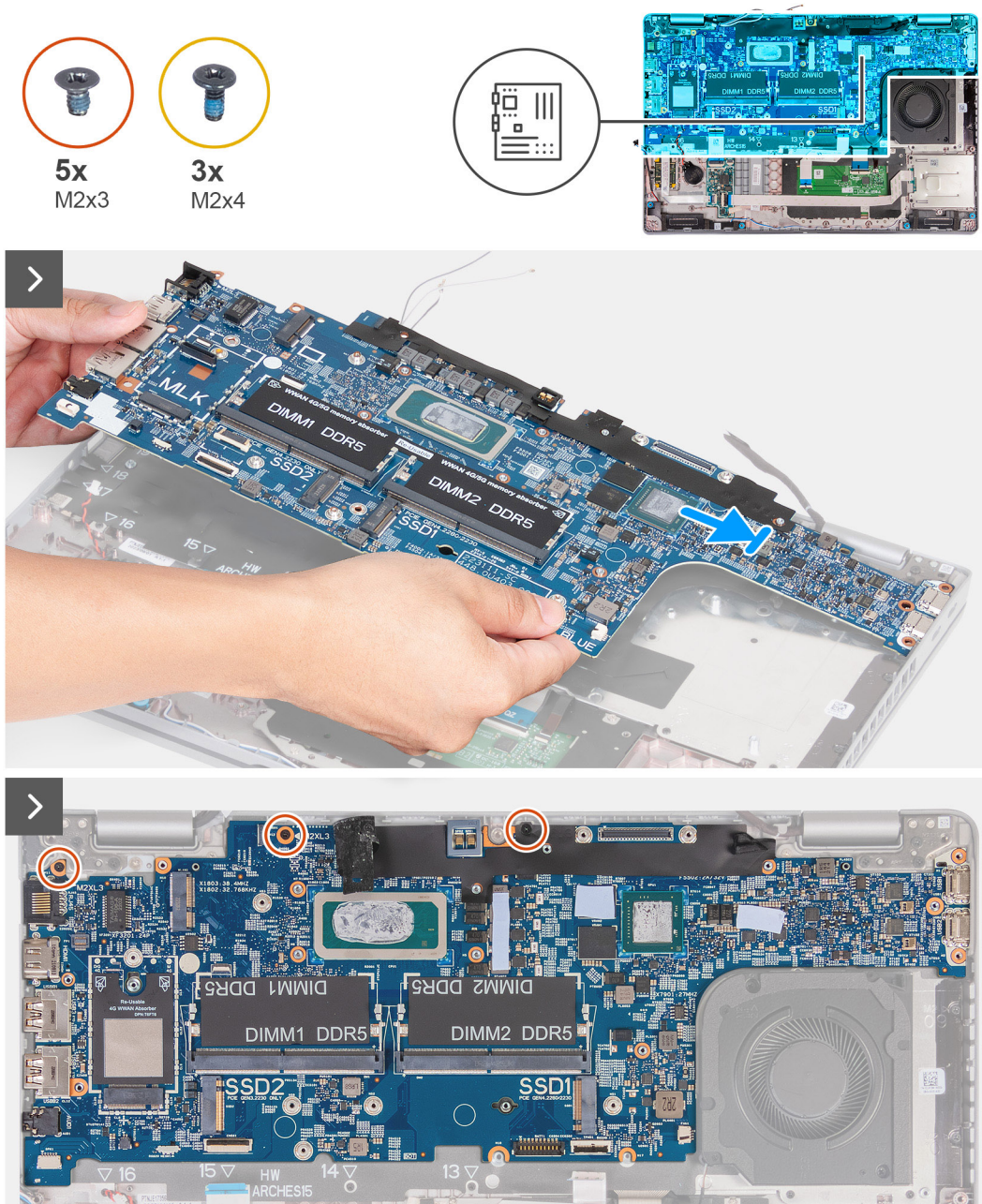

Figure 50. Image: System board connectors

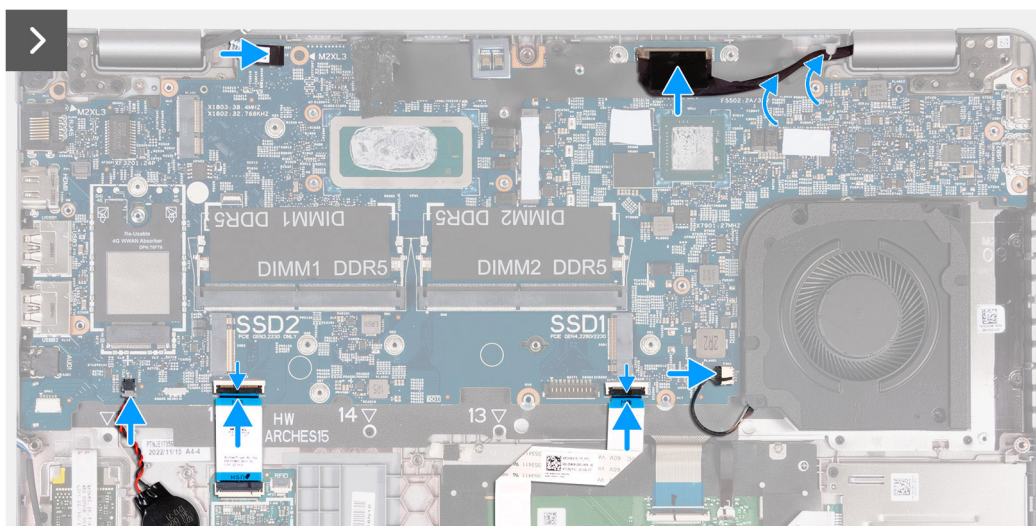

Figure 51. Image: System board connectors

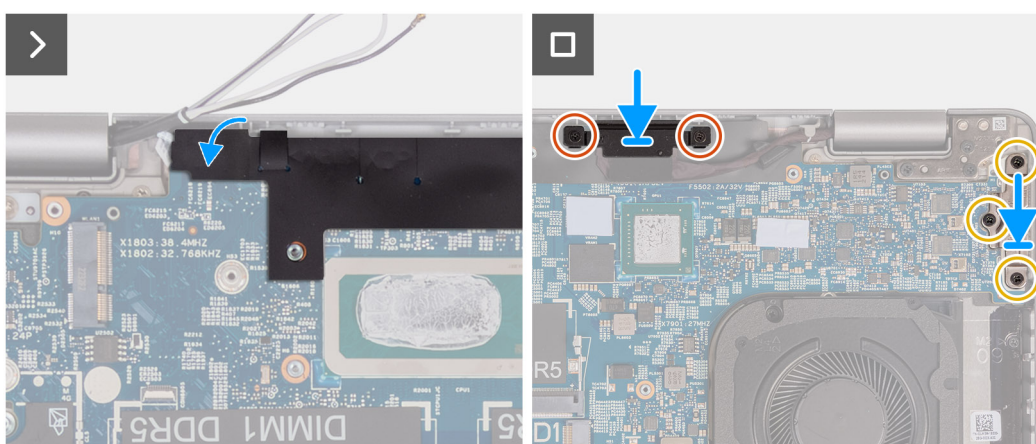

Figure 52. Image: System board connectors

Steps

1. Align and place the system board on its slot on the palm-rest assembly.
2. Replace the three screws (M2x3) that secure the system board to the palm-rest assembly.
3. Connect the sensor board-cable to the connector on the system board.
4. Connect the display cable to the connector on the system board.
5. Route the display cable through the routing guides on the system board.
6. Connect the fan cable to the connector on the system board.
7. Connect the touchpad cable to the connector on the system board and close the latch.
8. Connect the USH cable to the USH module and close the latch.
9. Connect the coin-cell battery cable to the connector on the system board.
10. Adhere the black flap near the antenna cables and cover the sensor board-cable.
11. Place the display-cable bracket over the display cable.
12. Replace the two screws (M2x3) that secure the display-cable bracket to the palm-rest assembly.
13. Place the Type-C bracket on its slot on the palm-rest assembly.
14. Replace the three screws (M2x4) that secure the Type-C bracket to the palm-rest assembly.

Next steps

1. Install the [assembly-inner frame](#).
2. Install the [battery](#).

3. Install the [heat sink \(discrete GPU\)](#) or [heat sink \(integrated GPU\)](#), as applicable.
4. Install the [M.2 2230 solid-state drive in Slot 2](#), if applicable.
5. Install the [M.2 2230](#) or [M.2 2280](#) solid-state drive in Slot 1, as applicable.
6. Install the [memory modules](#).
7. Install the [WLAN card](#).
8. Install the [4G WWAN card](#) or [5G WWAN card](#), as applicable.
9. Install the [base cover](#).
10. Install the [SIM card](#).
11. Follow the procedure in [After working inside your computer](#).

Power button

Removing the power button

 **CAUTION:** The information in this section is intended for authorized service technicians only.

Prerequisites

1. Follow the procedure in [Before working inside your computer](#).
2. Remove the [SIM card](#).
3. Remove the [base cover](#).
4. Remove the [battery](#).
5. Remove the [4G WWAN card](#) or [5G WWAN card](#), as applicable.
6. Remove the [WLAN card](#).
7. Remove the [memory modules](#).
8. Remove the [M.2 2230](#) or [M.2 2280](#) solid-state drive from Slot 1, as applicable.
9. Remove the [M.2 2230 solid-state drive from Slot 2](#), if applicable.
10. Remove the [heat sink \(discrete GPU\)](#) or [heat sink \(integrated GPU\)](#), as applicable.
11. Remove the [assembly-inner frame](#).
12. Remove the [system board](#).

About this task

The following images indicate the location of the power button and provide a visual representation of the removal procedure.

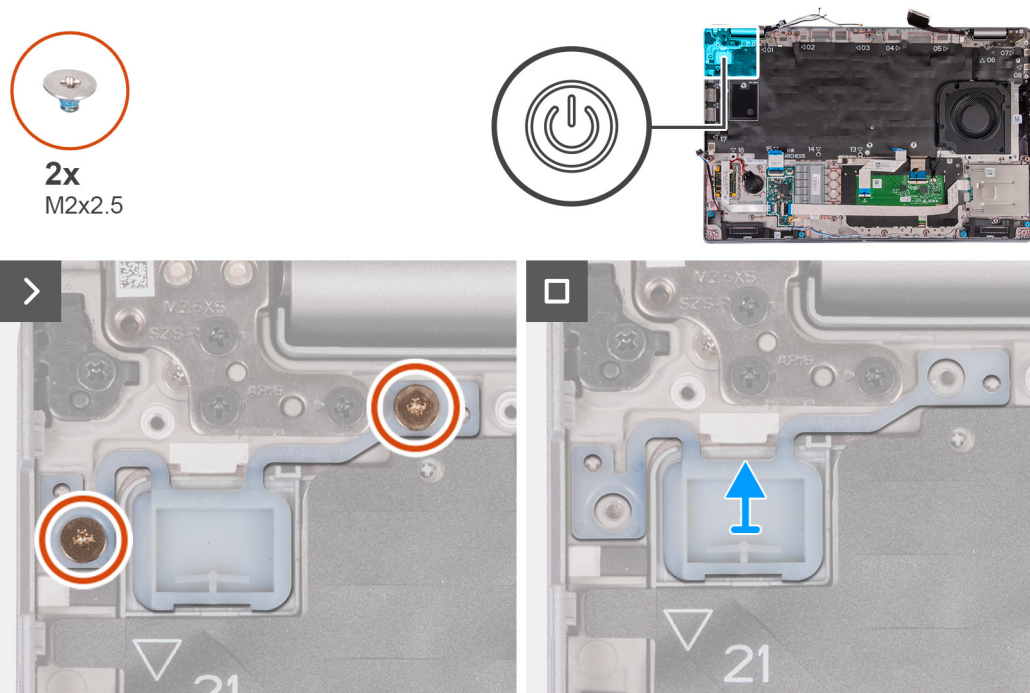

Figure 53. Image: Power button

Steps

1. Remove the two (M2x2.5) screws that secure the power button to the palm-rest assembly.
2. Lift the power button off the palm-rest assembly.

Installing the power button

CAUTION: The information in this section is intended for authorized service technicians only.

Prerequisites

If you are replacing a component, remove the existing component before performing the installation process.

About this task

The following images indicate the location of the power board and provide a visual representation of the installation procedure.

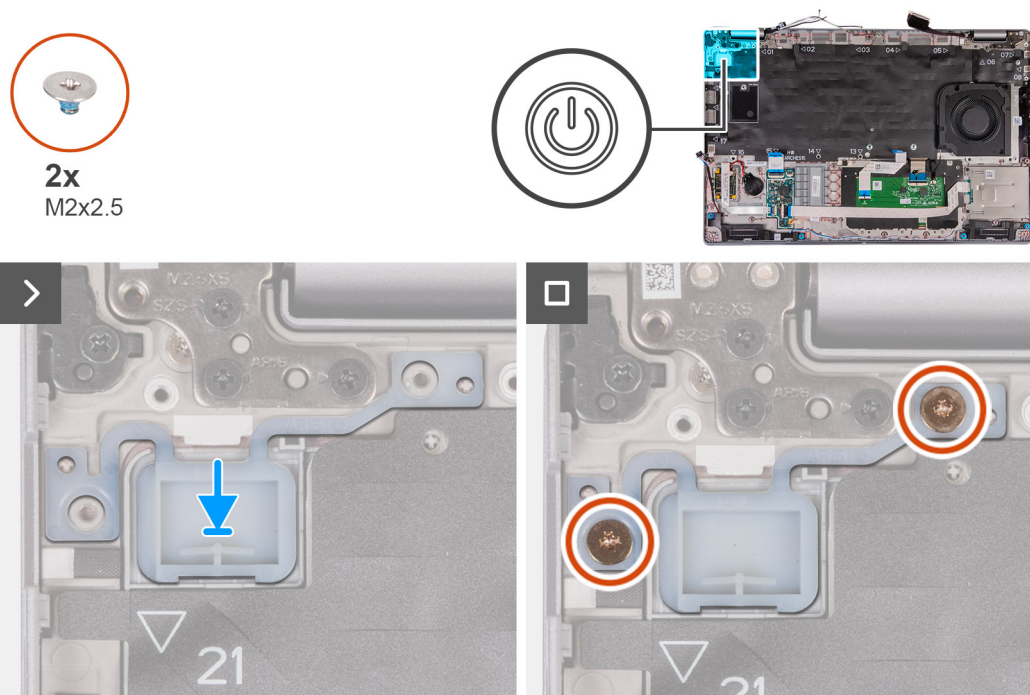

Figure 54. Image: Power button

Steps

1. Align and place the power button on the palm-rest assembly.
2. Replace the two (M2x2.5) screws to secure the power button to the palm-rest assembly.

Next steps

1. Install the [system board](#).
2. Install the [assembly-inner frame](#).
3. Install the [heat sink \(discrete GPU\)](#) or [heat sink \(integrated GPU\)](#), as applicable.
4. Install the [M.2 2230 solid-state drive in Slot 2](#), if applicable.
5. Install the [M.2 2230](#) or [M.2 2280](#) solid-state drive in Slot 1, as applicable.
6. Install the [memory modules](#).
7. Install the [WLAN card](#).
8. Install the [4G WWAN card](#) or [5G WWAN card](#), as applicable.
9. Install the [battery](#).
10. Install the [base cover](#).
11. Install the [SIM card](#).
12. Follow the procedure in [After working inside your computer](#).

Power button with optional fingerprint reader

Removing the power button with optional fingerprint reader

CAUTION: The information in this section is intended for authorized service technicians only.

Prerequisites

1. Follow the procedure in [Before working inside your computer](#).
2. Remove the [SIM card](#).
3. Remove the [base cover](#).

4. Remove the [battery](#).
5. Remove the [4G WWAN card](#) or [5G WWAN card](#), as applicable.
6. Remove the [WLAN card](#).
7. Remove the [memory modules](#).
8. Remove the [M.2 2230](#) or [M.2 2280](#) solid-state drive from Slot 1, as applicable.
9. Remove the [M.2 2230 solid-state drive from Slot 2](#), if applicable.
10. Remove the [heat sink \(discrete GPU\)](#) or [heat sink \(integrated GPU\)](#), as applicable.
11. Remove the [assembly-inner frame](#).
12. Remove the [system board](#).

About this task

The following images indicate the location of the power button and provide a visual representation of the removal procedure.

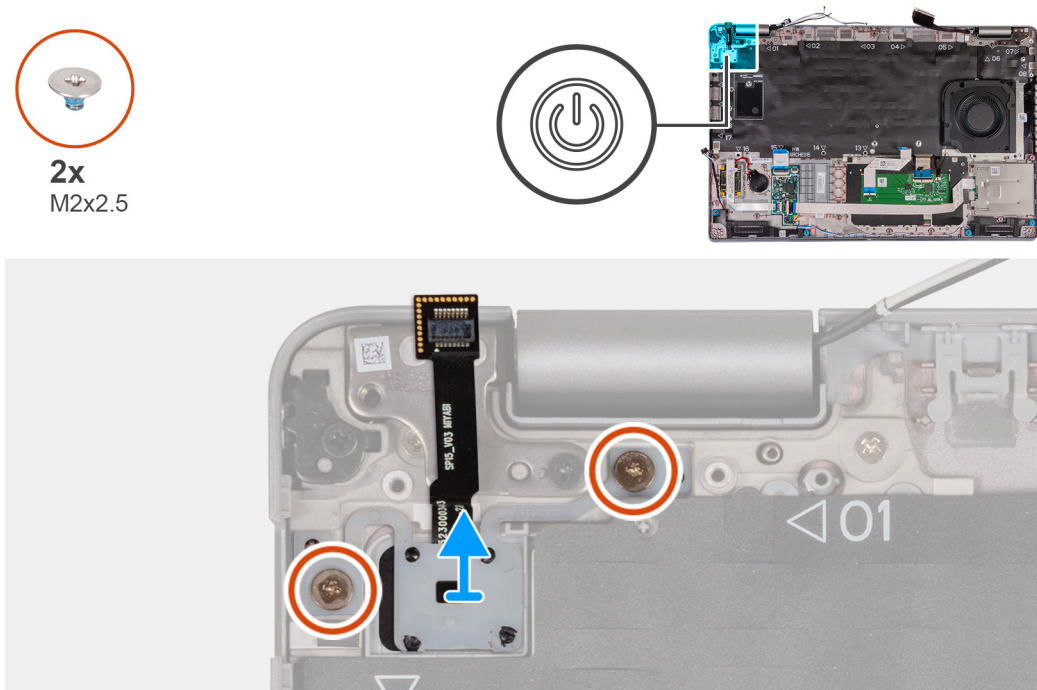

Figure 55. Image: Power button with optional fingerprint reader

Steps

1. Remove the two (M2x2.5) screws that secure the power button to the palm-rest assembly.
2. Lift the power button off the palm-rest assembly.

Installing the power button with optional fingerprint reader

CAUTION: The information in this section is intended for authorized service technicians only.

Prerequisites

If you are replacing a component, remove the existing component before performing the installation process.

About this task

The following images indicate the location of the power board and provide a visual representation of the installation procedure.

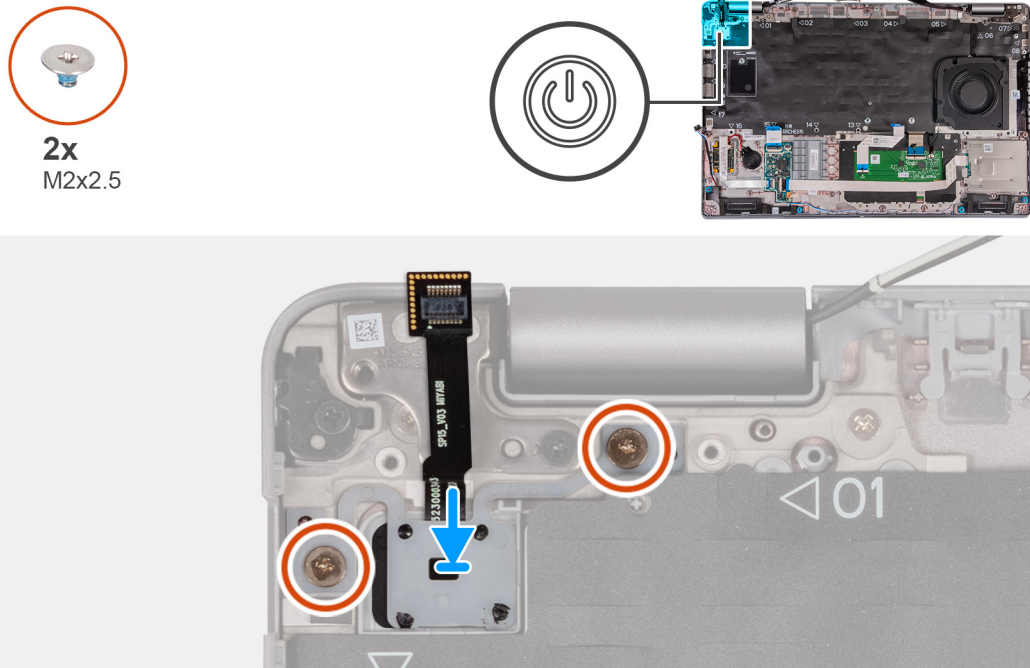

Figure 56. Image: Power button with optional fingerprint reader

Steps

1. Align and place the power button on the palm-rest assembly.
2. Replace the two (M2x2.5) screws to secure the power button to the palm-rest assembly.

Next steps

1. Install the [system board](#).
2. Install the [assembly-inner frame](#).
3. Install the [heat sink \(discrete GPU\)](#) or [heat sink \(integrated GPU\)](#), as applicable.
4. Install the [M.2 2230 solid-state drive in Slot 2](#), if applicable.
5. Install the [M.2 2230](#) or [M.2 2280](#) solid-state drive in Slot 1, as applicable.
6. Install the [memory modules](#).
7. Install the [WLAN card](#).
8. Install the [4G WWAN card](#) or [5G WWAN card](#), as applicable.
9. Install the [battery](#).
10. Install the [base cover](#).
11. Install the [SIM card](#).
12. Follow the procedure in [After working inside your computer](#).

Keyboard

Removing the keyboard

CAUTION: The information in this section is intended for authorized service technicians only.

Prerequisites

1. Follow the procedure in [Before working inside your computer](#).
2. Remove the [SIM card](#).
3. Remove the [base cover](#).

4. Remove the [battery](#).
5. Remove the [4G WWAN card](#) or [5G WWAN card](#), as applicable.
6. Remove the [WLAN card](#).
7. Remove the [memory modules](#).
8. Remove the [M.2 2230](#) or [M.2 2280](#) solid-state drive from Slot 1.
9. Remove the [M.2 2230 solid-state drive from Slot 2](#).
10. Remove the [heat sink](#).
11. Remove the [assembly inner frame](#).
12. Remove the [system board](#).

About this task

The following images indicate the location of the keyboard and provide a visual representation of the removal procedure.

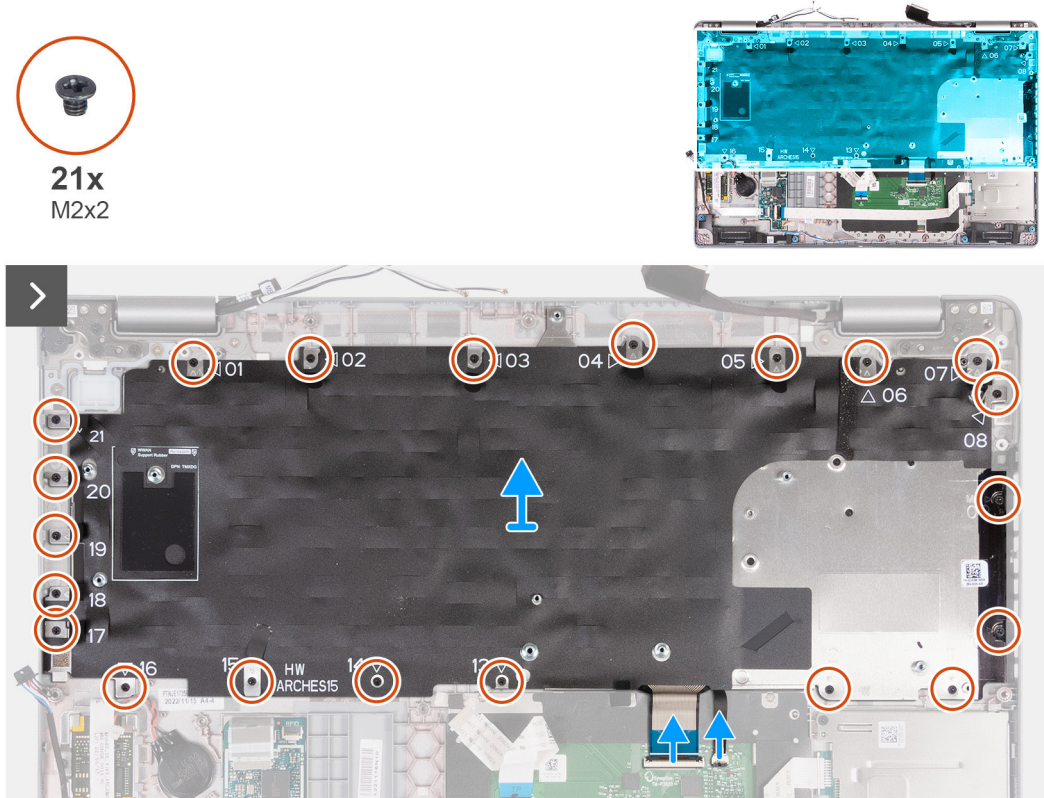

Figure 57. Image: Keyboard



10x
M2x2



Figure 58. Image: Keyboard

Steps

1. Open the latch and disconnect the keyboard cable from the touchpad.
2. Open the latch and disconnect the keyboard-backlight cable from the touchpad.
3. Remove the twenty one screws (M2x2) that secure the keyboard bracket to the palm-rest assembly.
4. Lift the keyboard bracket off the palm-rest assembly.
5. Turn the keyboard bracket over.
6. Remove the ten screws (M2x2) that secure the keyboard to the keyboard bracket.
7. Lift the keyboard off the keyboard bracket.

Installing the keyboard

CAUTION: The information in this section is intended for authorized service technicians only.

Prerequisites

If you are replacing a component, remove the existing component before performing the installation process.

About this task

The following images indicate the location of the keyboard and provide a visual representation of the installation procedure.



10x
M2x2



Figure 59. Image: Keyboard



21x
M2x2

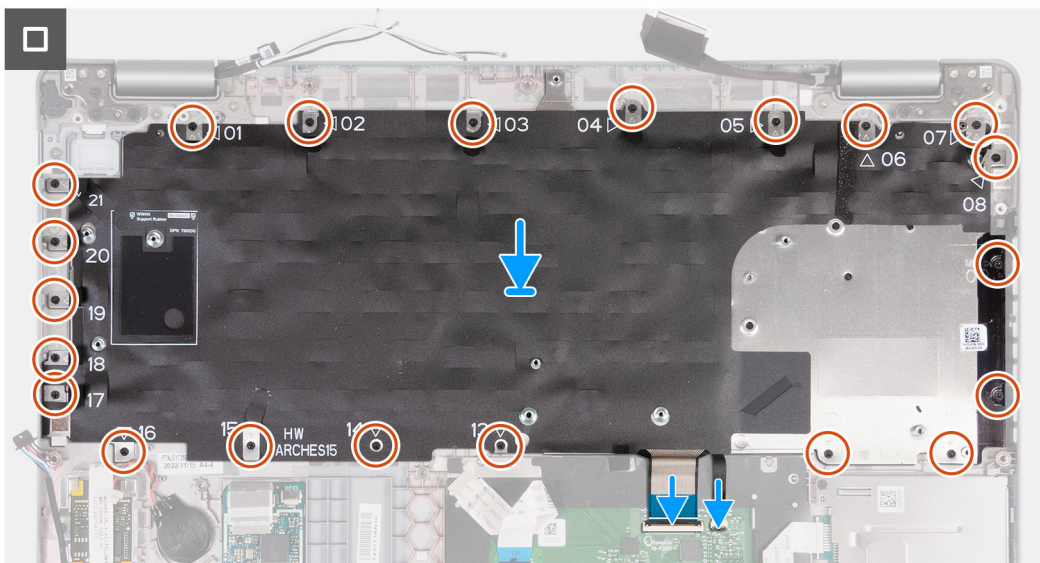
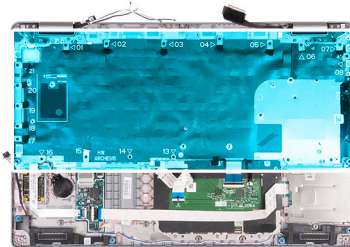

Figure 60. Image: Keyboard

Steps

1. Align and place the keyboard on the keyboard bracket.
2. Replace the ten screws (M2x2) to secure the keyboard to the keyboard bracket.
3. Turn the keyboard bracket over.
4. Align and place the keyboard bracket on the palm-rest assembly.
5. Replace the twenty one screws (M2x2) that secure the keyboard bracket to the palm-rest assembly.
6. Connect the keyboard-backlight cable to the connector on the touchpad and close the latch to secure the cable.
7. Connect the keyboard cable to the connector on the touchpad and close the latch to secure the cable.

Next steps

1. Install the [system board](#).
2. Install the [assembly inner frame](#).
3. Install the [heat sink](#).
4. Install the [M.2 2230 solid-state drive in Slot 2](#).
5. Install the [M.2 2230](#) or [M.2 2280](#) solid-state drive in Slot 1.
6. Install the [memory modules](#).
7. Install the [WLAN card](#).
8. Install the [4G WWAN card](#) or [5G WWAN card](#), as applicable.
9. Install the [battery](#).
10. Install the [base cover](#).
11. Install the [SIM card](#).
12. Follow the procedure in [After working inside your computer](#).

Display assembly

Removing the display assembly

 **CAUTION:** The information in this section is intended for authorized service technicians only.

Prerequisites

1. Follow the procedure in [Before working inside your computer](#).
2. Remove the [SIM card](#).
3. Remove the [base cover](#).
4. Remove the [4G WWAN card](#) or [5G WWAN card](#), as applicable.
5. Remove the [WLAN card](#).

About this task

The following images indicate the location of the display assembly and provide a visual representation of the removal procedure.

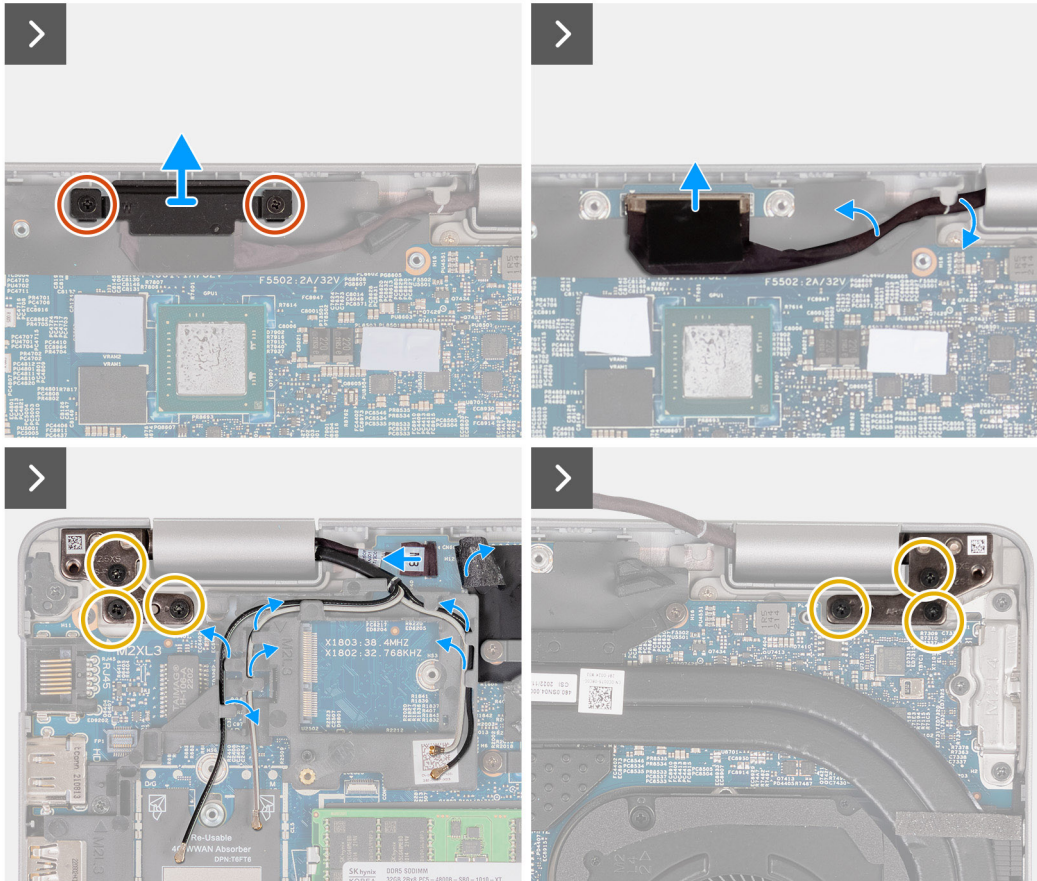
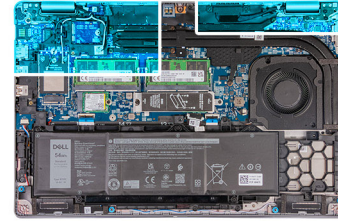

Figure 61. Image: Display assembly

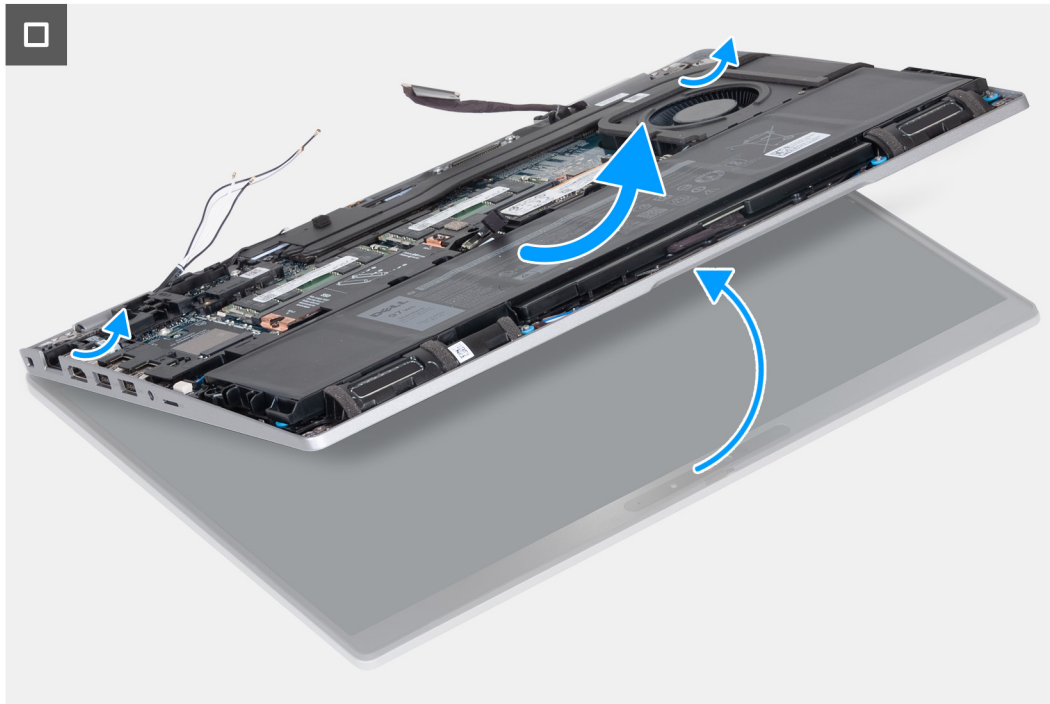

Figure 62. Image: Display assembly

Steps

1. Remove the two (M2x3) screws that secure the display-cable bracket to the system board.
2. Lift the display-cable bracket off the palm-rest assembly.
3. Disconnect the display cable from the system board.
4. Remove the display cable from the routing guides on the system board.
5. Lift the black flap near the antenna cables and uncover the sensor-board cable.
6. Disconnect the sensor-board cable from the connector on the system board.
7. Remove the WLAN and WWAN antennas (where applicable) from the routing guides on the system board.
8. Remove the six screws (M2.5x5) that secure the left and right display hinges to the palm-rest assembly.
9. Carefully lift the display assembly from the palm-rest assembly.
10. Carefully place the display assembly on a clean, flat surface.



Figure 63. Image: Display assembly

Installing the display assembly

CAUTION: The information in this section is intended for authorized service technicians only.

Prerequisites

If you are replacing a component, remove the existing component before performing the installation process.

About this task

The following images indicate the location of the display assembly and provide a visual representation of the installation procedure.

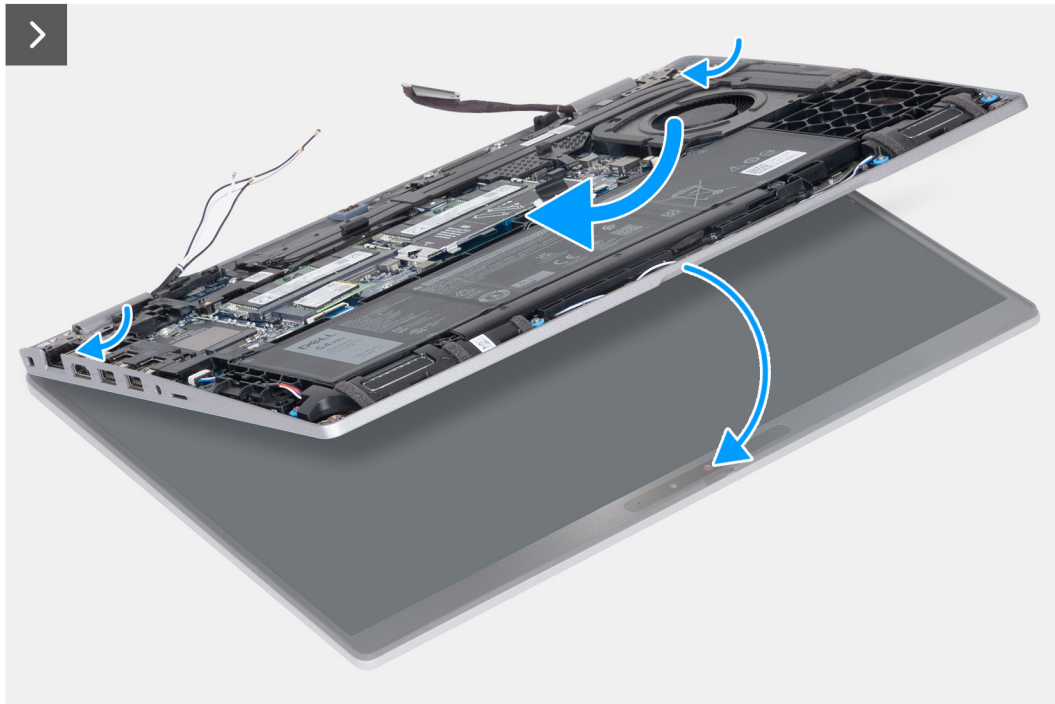

Figure 64. Image: Display assembly

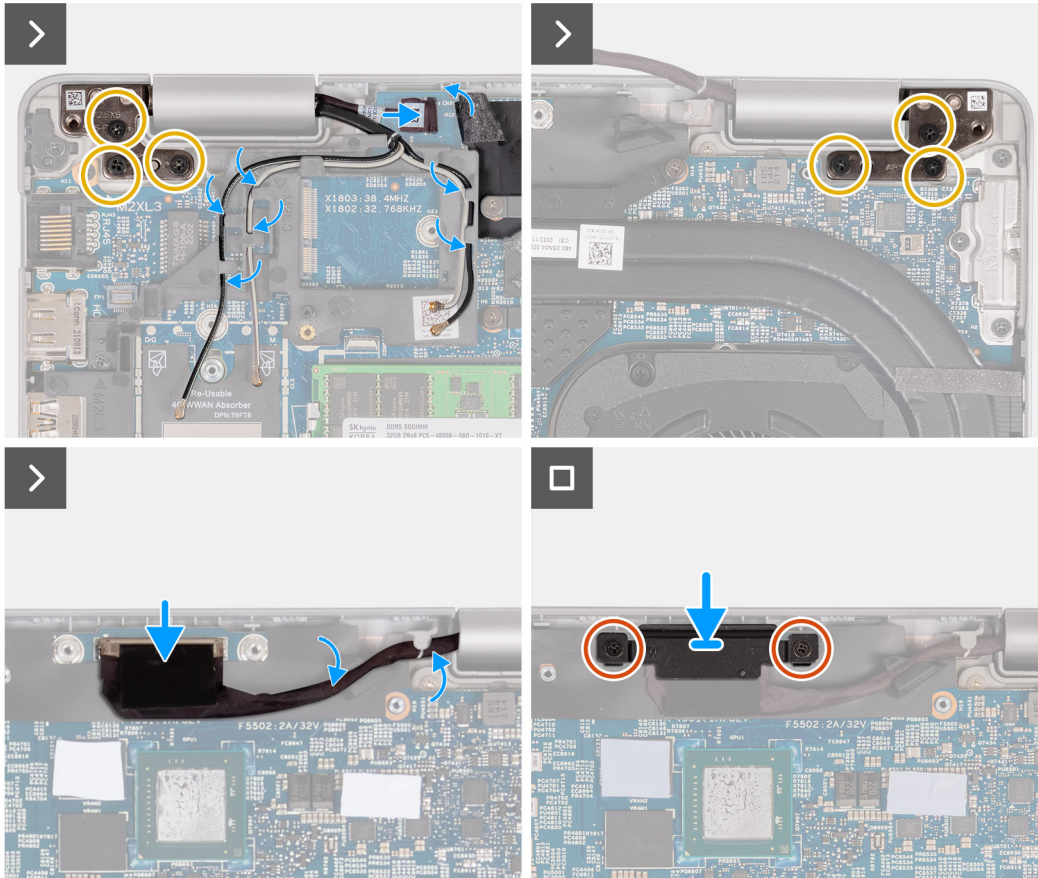
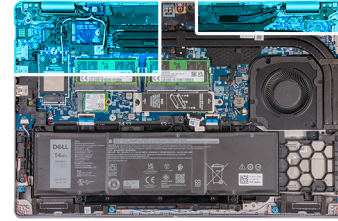

Figure 65. Image: Display assembly

Steps

1. Place the palm-rest assembly at the edge of the table with the speakers facing away from the edge.
2. Align the screw holes on the palm-rest assembly with the screw holes on the display hinges.
3. Replace the six screws (M2.5x5) that secure the left and right display hinges to the palm-rest assembly.
4. Connect the sensor-board cable to the connector on the system board.
5. Cover the sensor-board cable with the black flap near the antenna cables.
6. Route the WLAN and WWAN antennas (where applicable) from the routing guides on the system board.
7. Connect the display cable to the system board.
8. Adhere the tape that secures the display cable to the system board.
9. Align the screw holes on the display-cable bracket with the screw holes on the system board.
10. Replace the two (M2x3) screws that secure the display cable bracket to the system board.

Next steps

1. Install the [WLAN card](#).
2. Install the [4G WWAN card](#) or [5G WWAN card](#), as applicable.
3. Install the [base cover](#).
4. Install the [SIM card](#).

5. Follow the procedure in [After working inside your computer](#).

Display bezel

Removing the display bezel

CAUTION: The information in this section is intended for authorized service technicians only.

Prerequisites

1. Follow the procedure in [Before working inside your computer](#).
2. Remove the [SIM card](#).
3. Remove the [base cover](#).
4. Remove the [4G WWAN card](#) or [5G WWAN card](#), as applicable.
5. Remove the [WLAN card](#).
6. Remove the [display assembly](#).

About this task

The following images indicate the location of the display bezel and provide a visual representation of the removal procedure.

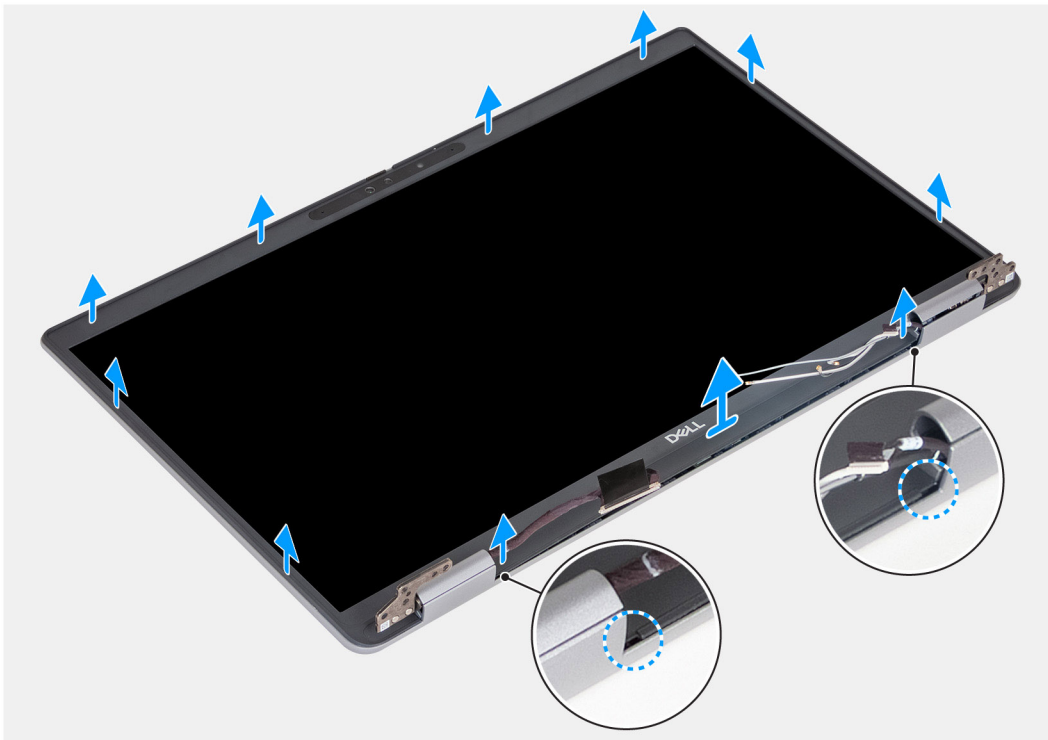

Figure 66. Image: Display bezel

Steps

1. Carefully pry up the display bezel starting from the recesses on the bottom edge of the display near the left and right hinges.
2. Pry along the outside edge of the display bezel and work your way around the entire display bezel until the display bezel is separated from the display cover.
3. Lift the display bezel from the display assembly.

Installing the display bezel

CAUTION: The information in this section is intended for authorized service technicians only.

Prerequisites

If you are replacing a component, remove the existing component before performing the installation process.

About this task

The following images indicate the location of the display bezel and provide a visual representation of the installation procedure.

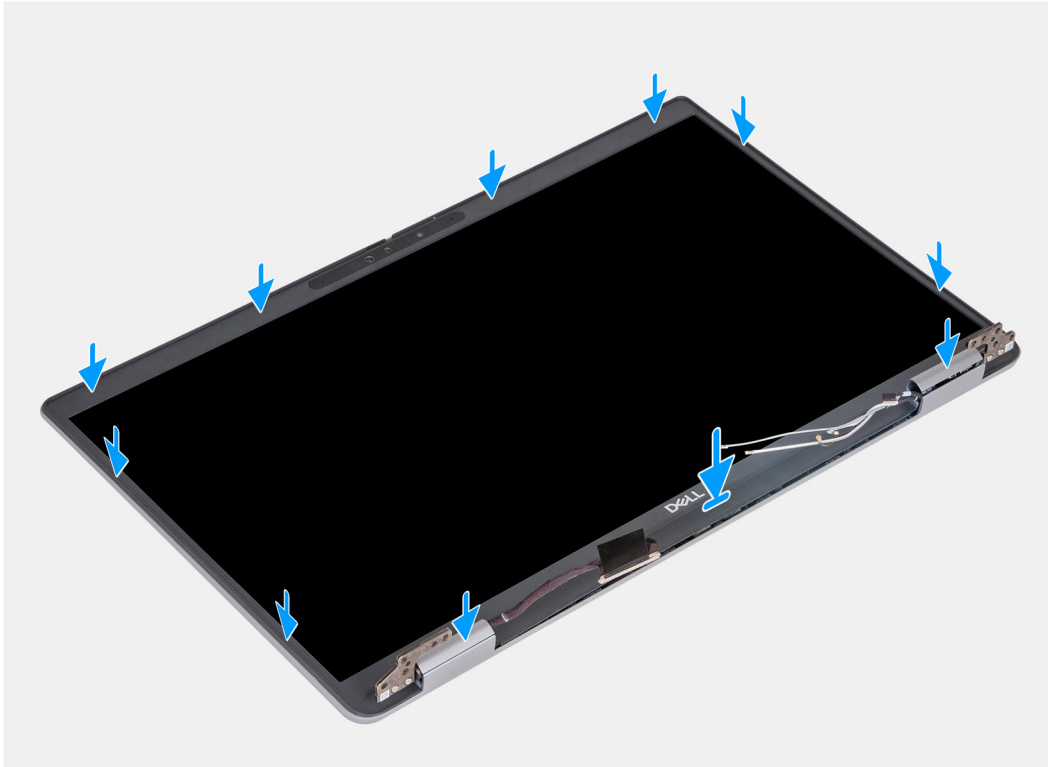

Figure 67. Image: Display bezel

Steps

1. Align and place the display bezel on the display assembly.
2. Gently snap the display bezel into place.

Next steps

1. Install the [display assembly](#).
2. Install the [WLAN card](#).
3. Install the [4G WWAN card](#) or [5G WWAN card](#), as applicable.
4. Install the [base cover](#).
5. Install the [SIM card](#).
6. Follow the procedure in [After working inside your computer](#).

Display panel

Removing the display panel

CAUTION: The information in this section is intended for authorized service technicians only.

Prerequisites

1. Follow the procedure in [Before working inside your computer](#).
2. Remove the [SIM card](#).
3. Remove the [base cover](#).
4. Remove the [4G WWAN card](#) or [5G WWAN card](#), as applicable.
5. Remove the [WLAN card](#).
6. Remove the [display assembly](#).
7. Remove the [display bezel](#).

About this task

The following images indicate the location of the display panel and provide a visual representation of the removal procedure.



Figure 68. Image: Display panel

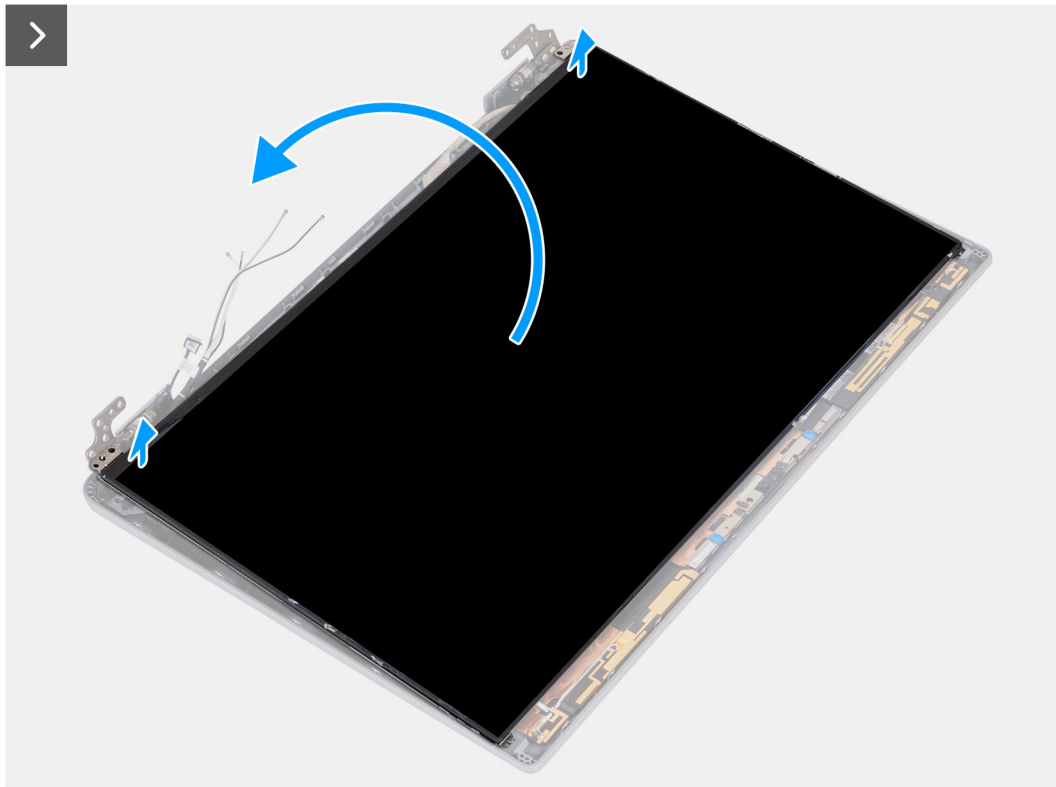

Figure 69. Image: Display panel

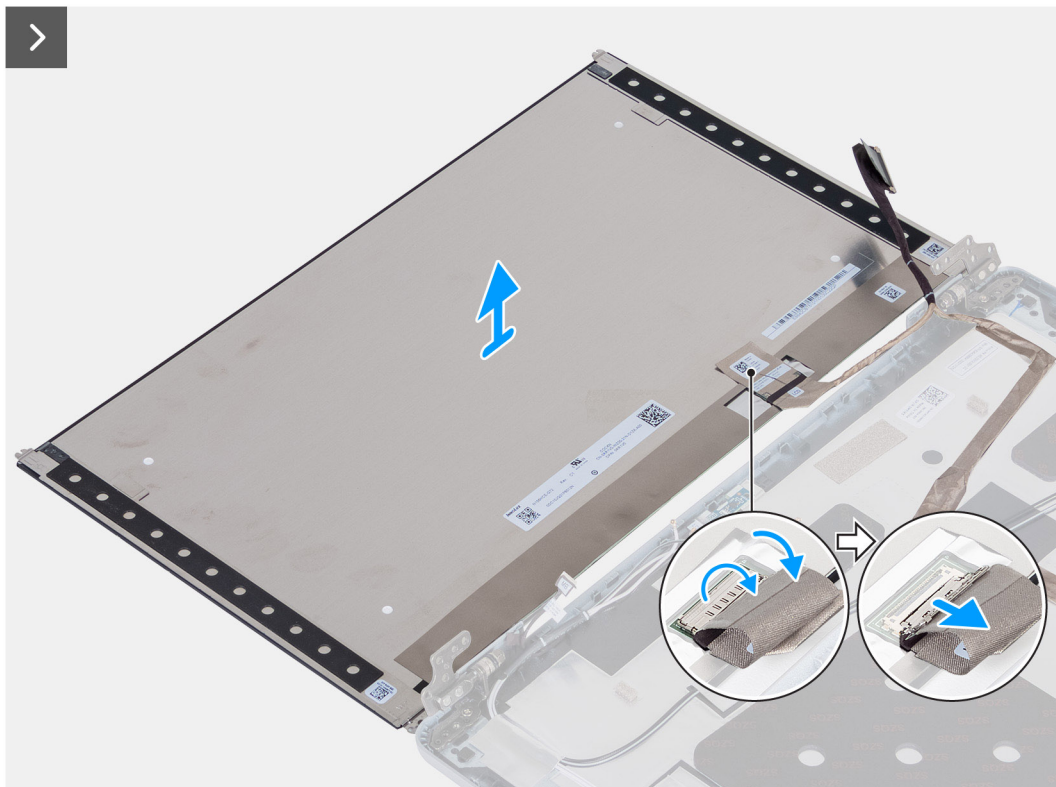

Figure 70. Image: Display panel

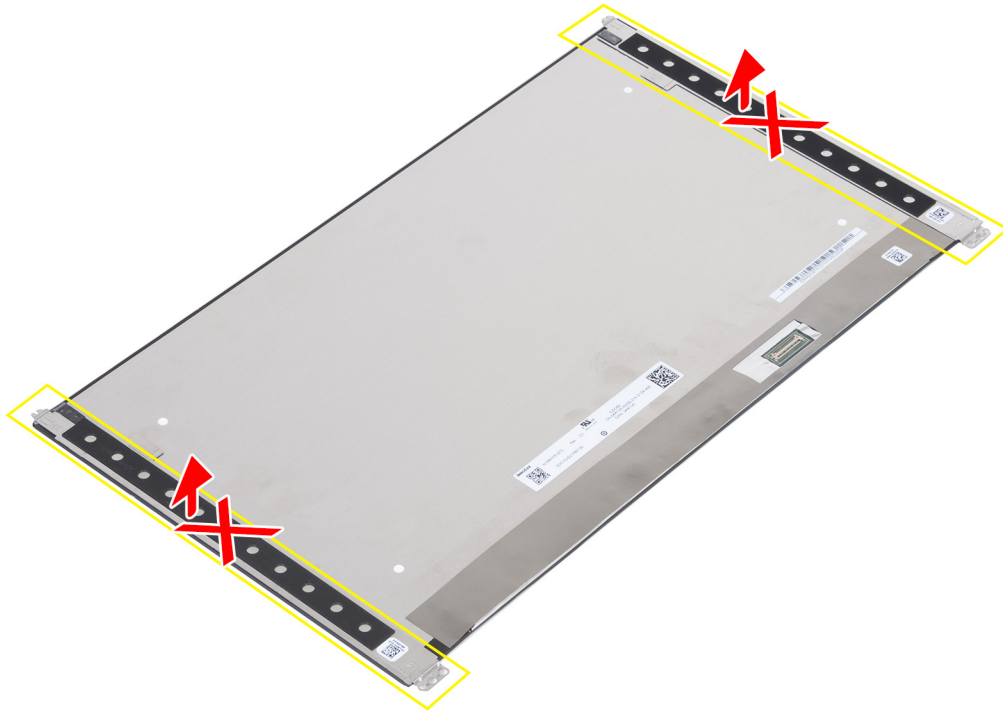

Figure 71. Image: Display panel

Steps

1. Remove the four screws (M2.5x3.5) that secure the display panel to the display back cover.
2. Lift and open the display panel to access the display cable.
3. Peel the conductive tape on the display cable connector.
4. Open the latch and disconnect the cable from the connector on the display panel.
5. Lift the display panel away from the display back cover.

Installing the display panel

 **CAUTION:** The information in this section is intended for authorized service technicians only.

Prerequisites

If you are replacing a component, remove the existing component before performing the installation process.

About this task

The following images indicate the location of the display panel and provide a visual representation of the installation procedure.



Figure 72. Image: Display panel

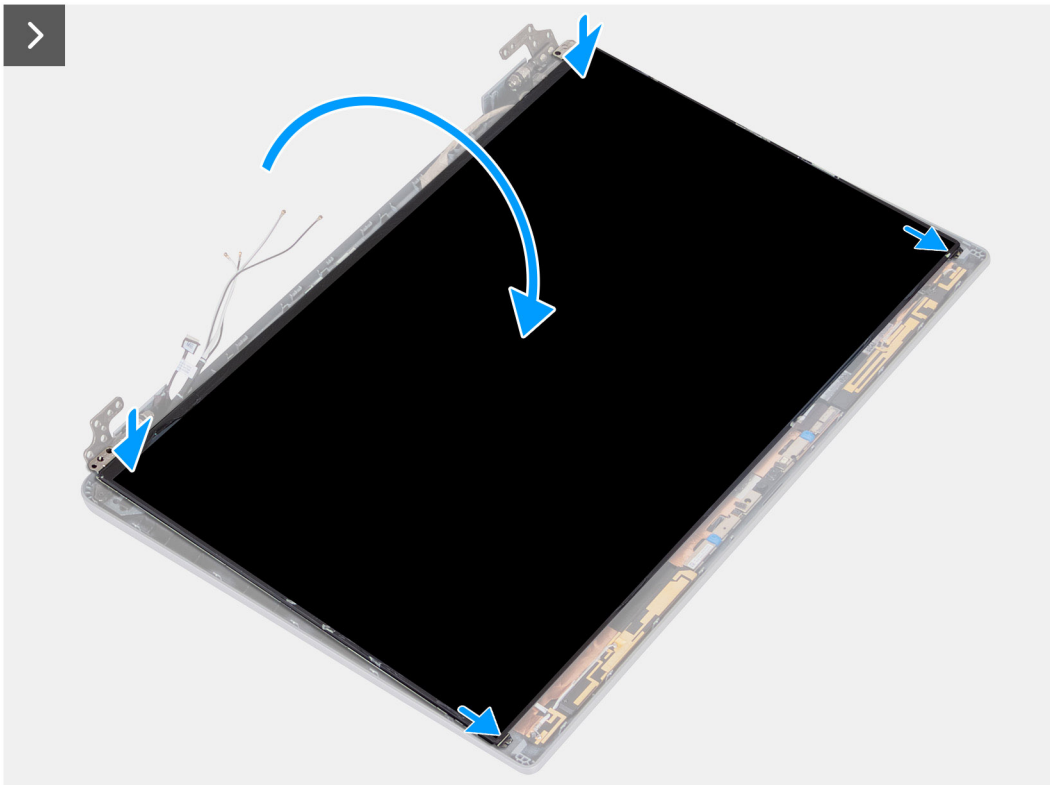
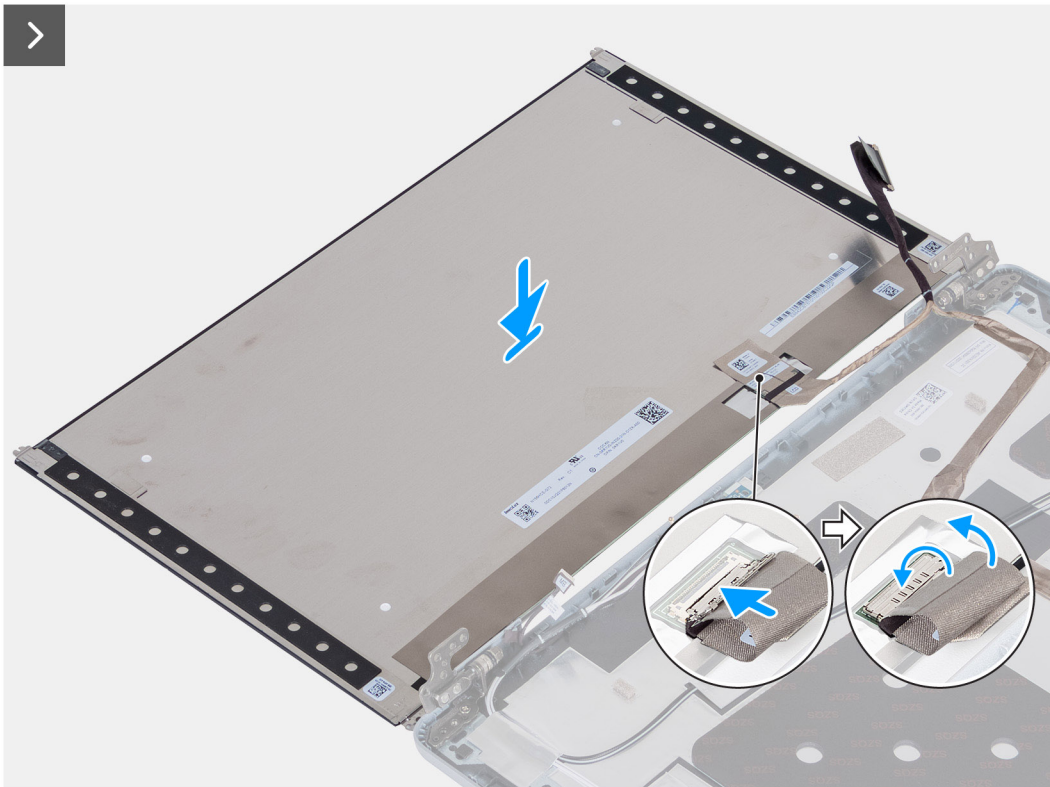



4x
M2.5x3.5



Steps

1. Connect the display cable to the connector on the display panel and close the latch.
2. Adhere the conductive tape to secure the display cable to the display panel.
3. Close the display panel and the display back cover to assemble.

i **NOTE:** Ensure that the display panel tabs are inserted into the slots on the display cover.

4. Replace the four screws (M2.5x3.5) to secure the display panel to the display back cover.

Next steps

1. Install the [display bezel](#).
2. Install the [display assembly](#).
3. Install the [WLAN card](#).
4. Install the [4G WWAN card](#) or [5G WWAN card](#), as applicable.
5. Install the [base cover](#).
6. Install the [SIM card](#).
7. Follow the procedure in [After working inside your computer](#).

Camera module

Removing the camera module

 **CAUTION:** The information in this section is intended for authorized service technicians only.

Prerequisites

1. Follow the procedure in [Before working inside your computer](#).
2. Remove the [SIM card](#).
3. Remove the [base cover](#).
4. Remove the [4G WWAN card](#) or [5G WWAN card](#), as applicable.
5. Remove the [WLAN card](#).
6. Remove the [display assembly](#).
7. Remove the [display bezel](#).
8. Remove the [display panel](#).

About this task

The following images indicate the location of the camera module and provide a visual representation of the removal procedure.

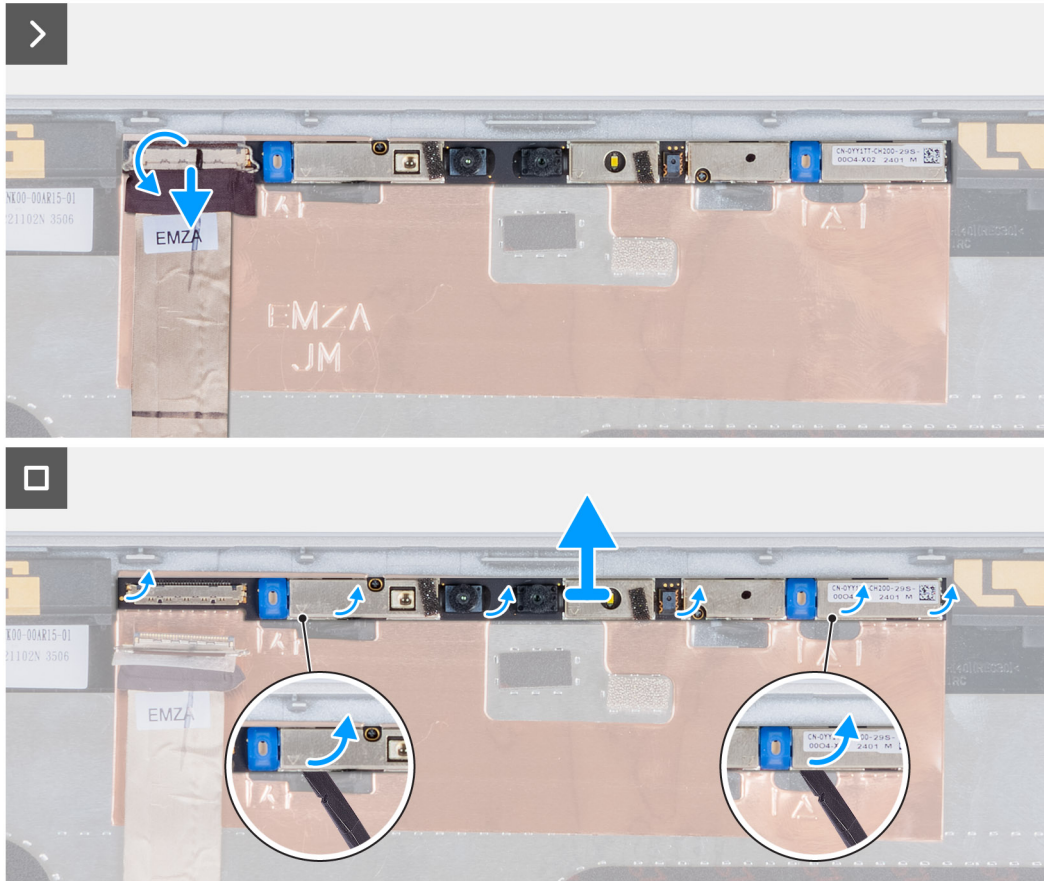
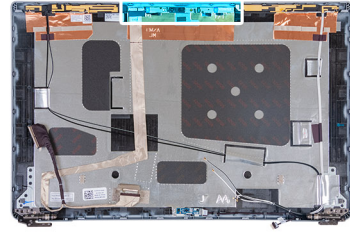

Figure 73. Image: Camera module

Steps

1. Peel the tape that secures the camera cable to the display back cover.
2. Disconnect the camera cable from the camera.
3. Carefully pry up the camera module starting from the prying point at the bottom edge of the camera module.
4. Lift the camera module from the display back cover.

Installing the camera module

CAUTION: The information in this section is intended for authorized service technicians only.

Prerequisites

If you are replacing a component, remove the existing component before performing the installation process.

About this task

The following images indicate the location of the camera module and provide a visual representation of the installation procedure.

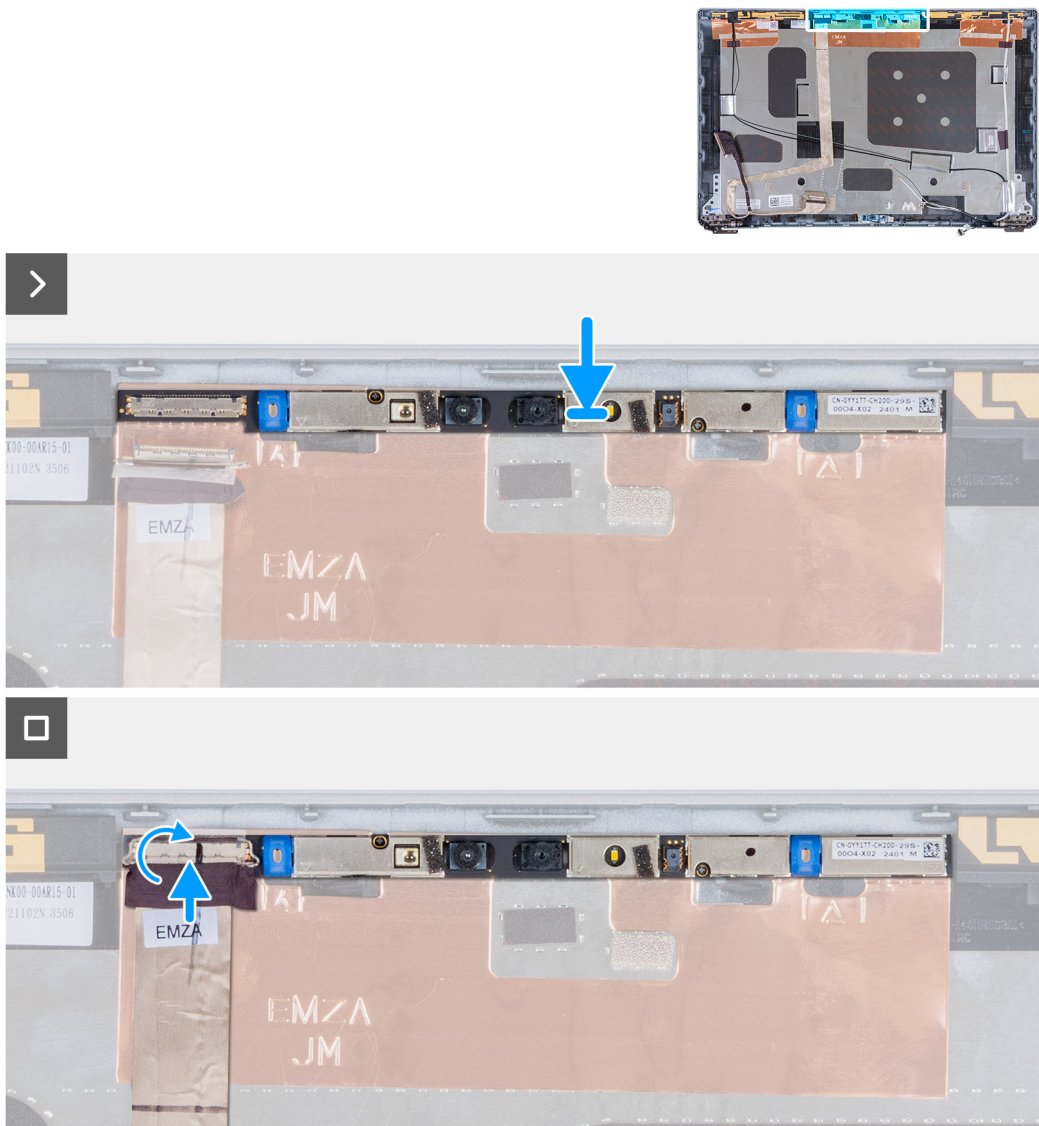

Figure 74. Installing the camera module

Steps

1. Align and place the camera module into the slot on the display back cover.
2. Connect the camera module cable to the connector on the camera module.
3. Adhere the tape to secure the camera cable to the camera.

Next steps

1. Install the [display panel](#).
2. Install the [display bezel](#).
3. Install the [display assembly](#).
4. Install the [WLAN card](#).
5. Install the [4G WWAN card](#) or [5G WWAN card](#), as applicable.
6. Install the [base cover](#).
7. Install the [SIM card](#).
8. Follow the procedure in [After working inside your computer](#).

Display hinges

Removing the display hinges

CAUTION: The information in this section is intended for authorized service technicians only.

Prerequisites

1. Follow the procedure in [Before working inside your computer](#).
2. Remove the [SIM card](#).
3. Remove the [base cover](#).
4. Remove the [4G WWAN card](#) or [5G WWAN card](#), as applicable.
5. Remove the [WLAN card](#).
6. Remove the [display assembly](#).
7. Remove the [display bezel](#).
8. Remove the [display panel](#).

About this task

The following images indicate the location of the display hinges and provide a visual representation of the removal procedure.



Figure 75. Image: Display hinges

Steps

1. Remove the screw (M2.5x3.5) that secures the right hinge to the display back cover.
2. Lift and remove the right hinge from the display back cover.
3. Remove the screw (M2.5x3.5) that secures the left hinge to the display back cover.
4. Lift and remove the left hinge from the display back cover.

Installing the display hinges

CAUTION: The information in this section is intended for authorized service technicians only.

Prerequisites

If you are replacing a component, remove the existing component before performing the installation process.

About this task

The following images indicate the location of the display hinges and provide a visual representation of the installation procedure.

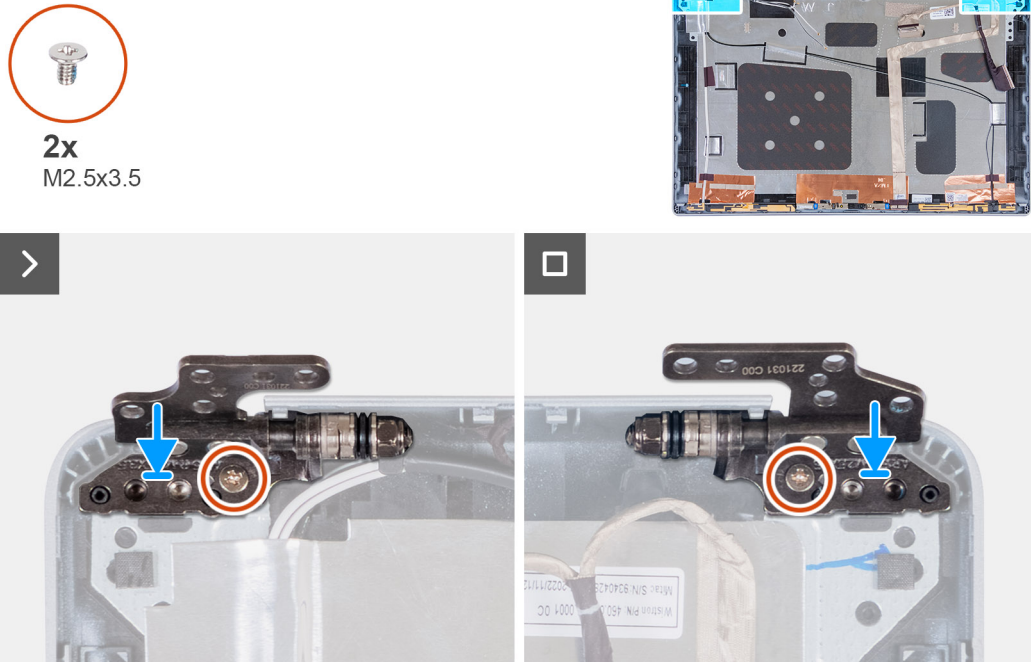

Figure 76. Image: Display hinges

Steps

1. Align the screw hole on the left hinge with the screw hole on the display back cover.
2. Replace the screw (M2.5x3.5) that secures the left hinge to the display back cover.
3. Align the screw hole on the right hinge with the screw hole on the display back cover.
4. Replace the screw (M2.5x3.5) that secures the right hinge to the display back cover.

Next steps

1. Install the [display panel](#).
2. Install the [display bezel](#).
3. Install the [display assembly](#).
4. Install the [WLAN card](#).
5. Install the [4G WWAN card](#) or [5G WWAN card](#), as applicable.
6. Install the [base cover](#).
7. Install the [SIM card](#).
8. Follow the procedure in [After working inside your computer](#).

Display back cover

Removing the display back cover

CAUTION: The information in this section is intended for authorized service technicians only.

Prerequisites

1. Follow the procedure in [Before working inside your computer](#).
2. Remove the [SIM card](#).
3. Remove the [base cover](#).
4. Remove the [4G WWAN card](#) or [5G WWAN card](#), as applicable.
5. Remove the [WLAN card](#).
6. Remove the [display assembly](#).
7. Remove the [display bezel](#).
8. Remove the [display panel](#).

About this task

The following images indicate the location of the display back cover and provide a visual representation of the removal procedure.

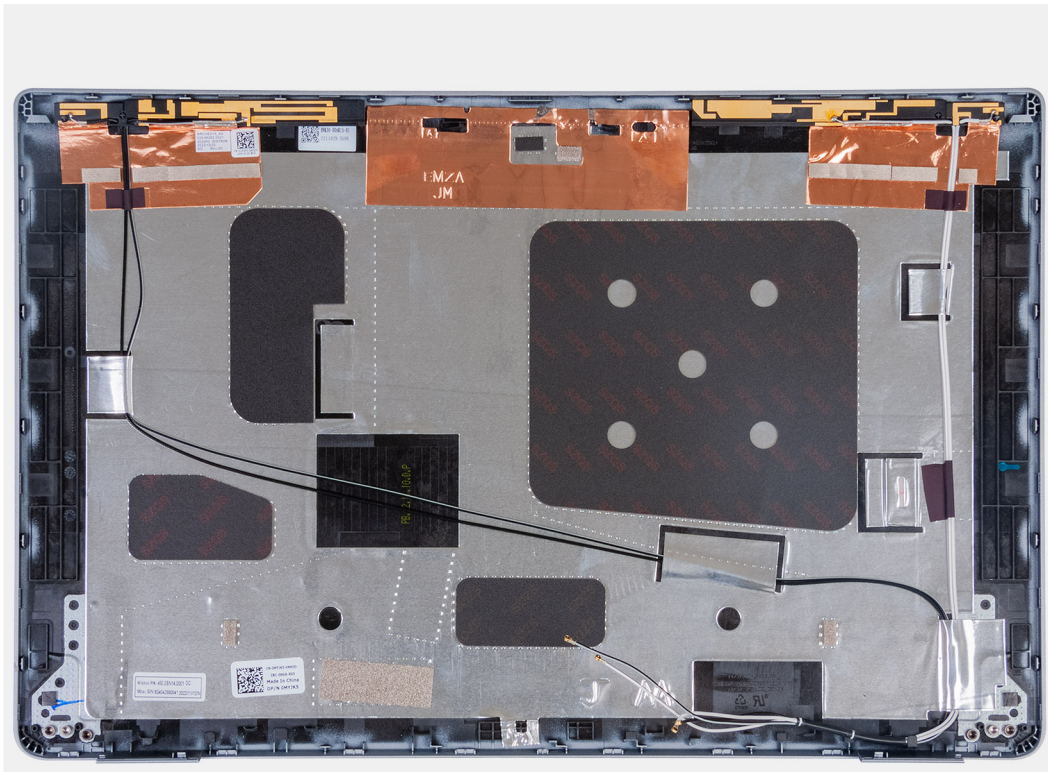

Figure 77. Image: Display back cover

Steps

After performing the steps in the pre-requisites, we are left with the display back cover.

Installing the display back cover

⚠ CAUTION: The information in this section is intended for authorized service technicians only.

Prerequisites

If you are replacing a component, remove the existing component before performing the installation process.

About this task

The following images indicate the location of the display back cover and provide a visual representation of the installation procedure.

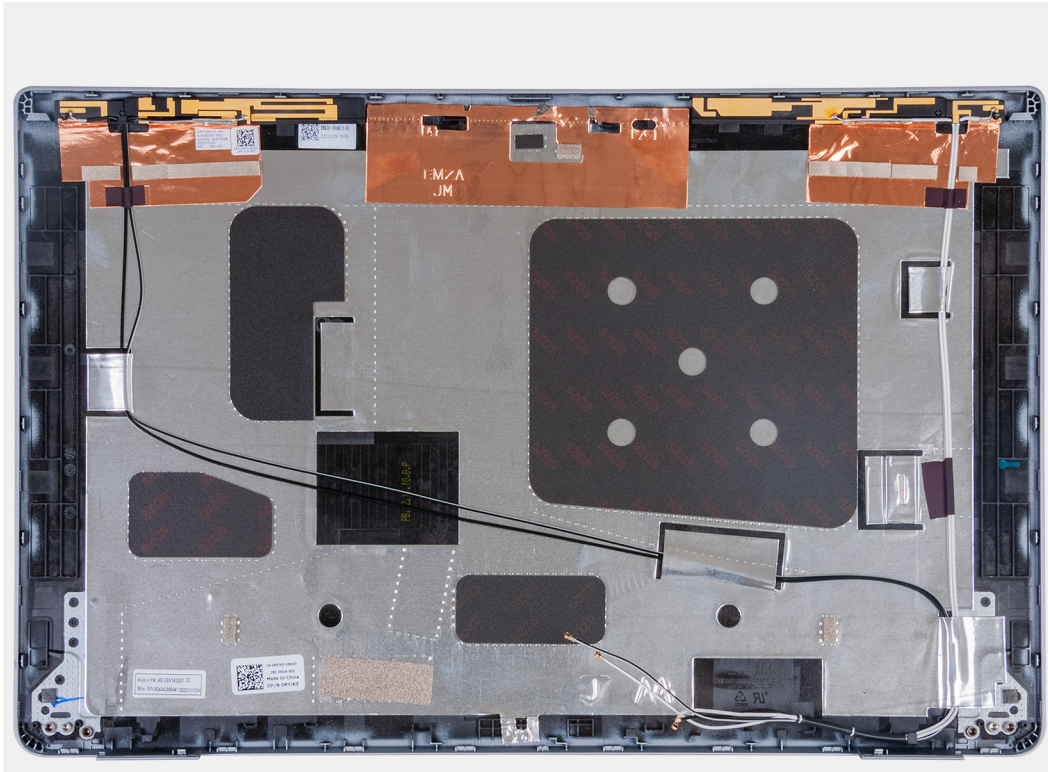

Figure 78. Image: Display back cover

Steps

Place the display back cover on a flat surface.

Next steps

1. Install the [display panel](#).
2. Install the [display bezel](#).
3. Install the [display assembly](#).
4. Install the [WLAN card](#).
5. Install the [4G WWAN card](#) or [5G WWAN card](#), as applicable.
6. Install the [base cover](#).
7. Install the [SIM card](#).
8. Follow the procedure in [After working inside your computer](#).

Display cable

Removing the display cable

CAUTION: The information in this section is intended for authorized service technicians only.

Prerequisites

1. Follow the procedure in [Before working inside your computer](#).
2. Remove the [SIM card](#).
3. Remove the [base cover](#).
4. Remove the [4G WWAN card](#) or [5G WWAN card](#), as applicable.
5. Remove the [WLAN card](#).
6. Remove the [display assembly](#).
7. Remove the [display bezel](#).

8. Remove the [display panel](#).

About this task

The following images indicate the location of the display cable and provide a visual representation of the removal procedure.



Figure 79. Image: Display cable

Steps

1. Peel the tape that secures the display cable to the display back cover.
2. Disconnect the display cable from the camera module.
3. Peel the display cable to release it from adhesive and lift the display cable off the display back cover.

Installing the display cable

 **CAUTION:** The information in this section is intended for authorized service technicians only.

Prerequisites

If you are replacing a component, remove the existing component before performing the installation process.

About this task

The following images indicate the location of the display cable and provide a visual representation of the installation procedure.

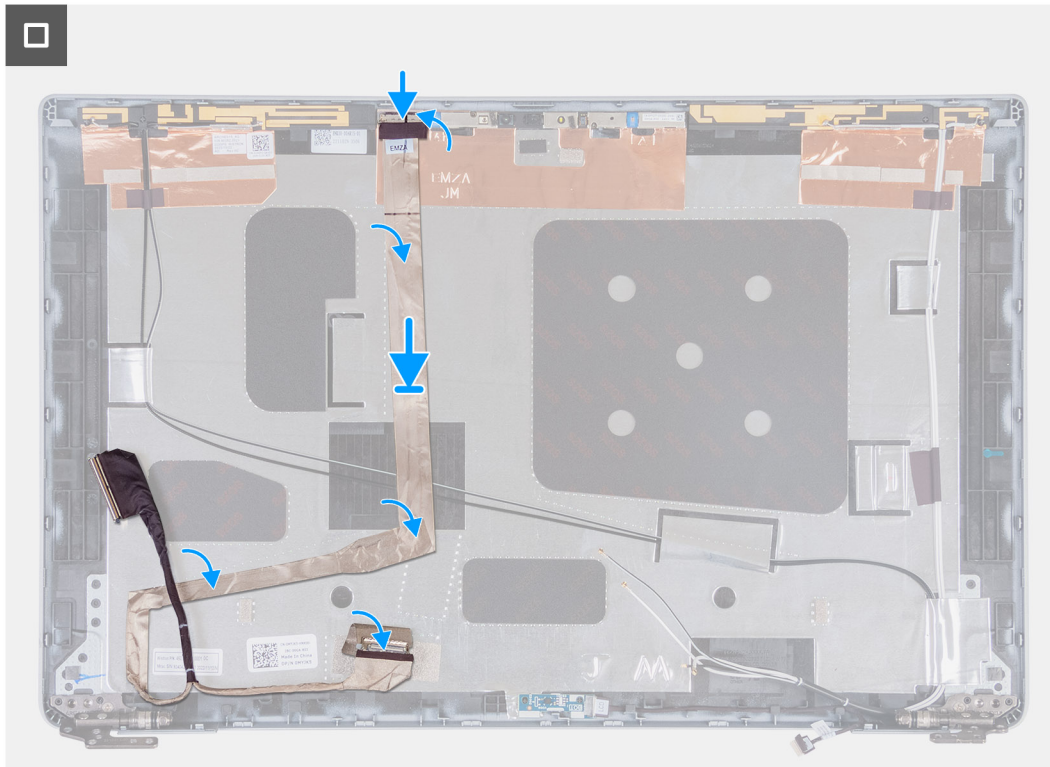

Figure 80. Image: Display cable

Steps

1. Connect the display cable to the connector on the camera.
2. Adhere the display cable to the display back cover.
3. Adhere the tape that secures the display cable to the display back cover.

Next steps

1. Install the [display panel](#).
2. Install the [display bezel](#).
3. Install the [display assembly](#).
4. Install the [WLAN card](#).
5. Install the [4G WWAN card](#) or [5G WWAN card](#), as applicable.
6. Install the [base cover](#).
7. Install the [SIM card](#).
8. Follow the procedure in [After working inside your computer](#).

Sensor board

Removing the sensor board

⚠ CAUTION: The information in this section is intended for authorized service technicians only.

Prerequisites

1. Follow the procedure in [Before working inside your computer](#).
2. Remove the [SIM card](#).
3. Remove the [base cover](#).
4. Remove the [4G WWAN card](#) or [5G WWAN card](#), as applicable.

5. Remove the [WLAN card](#).
6. Remove the [display assembly](#).
7. Remove the [display bezel](#).
8. Remove the [display panel](#).

About this task

The following images indicate the location of the sensor board and provide a visual representation of the removal procedure.

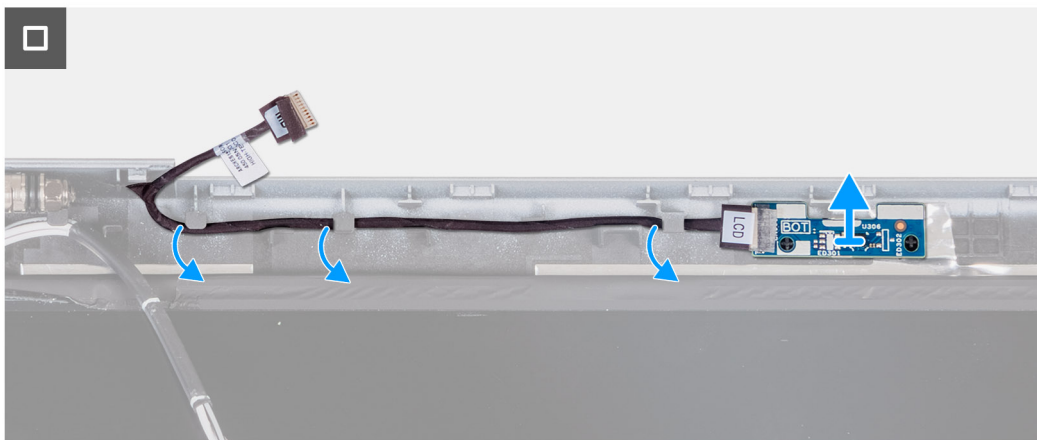

Figure 81. Sensor board

Steps

1. Remove the sensor-board cable from the routing guides on the display back cover.
2. Lift the sensor board, along with its cable, off the display back cover.

Installing the sensor board

CAUTION: The information in this section is intended for authorized service technicians only.

Prerequisites

If you are replacing a component, remove the existing component before performing the installation process.

About this task

The following images indicate the location of the sensor board and provide a visual representation of the installation procedure.

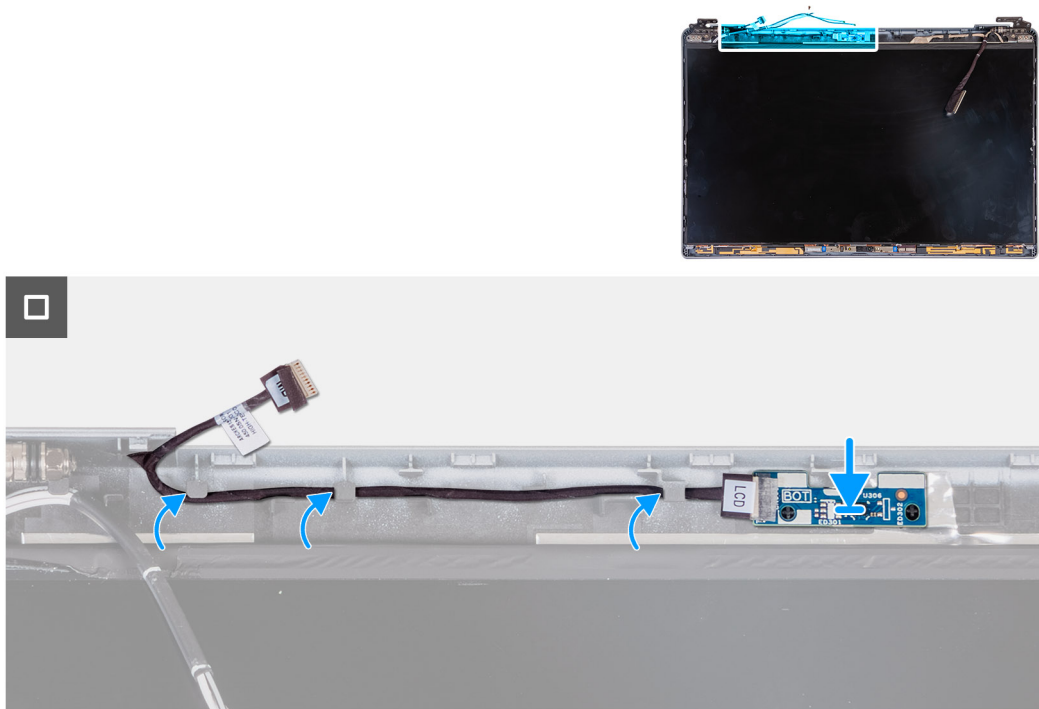

Figure 82. Sensor board

Steps

1. Place the sensor board on its slot on the display back cover.
2. Route the sensor-board cable through the routing guides on the display back cover.

Next steps

1. Install the [display panel](#).
2. Install the [display bezel](#).
3. Install the [display assembly](#).
4. Install the [WLAN card](#).
5. Install the [4G WWAN card](#) or [5G WWAN card](#), as applicable.
6. Install the [base cover](#).
7. Install the [SIM card](#).
8. Follow the procedure in [After working inside your computer](#).

Fingerprint reader (optional)

Removing the fingerprint reader (Optional)

CAUTION: The information in this section is intended for authorized service technicians only.

Prerequisites

1. Follow the procedure in [Before working inside your computer](#).
2. Remove the [SIM card](#).
3. Remove the [base cover](#).
4. Remove the [battery](#).
5. Remove the [assembly-inner frame](#).

About this task

The following image(s) indicate the location of the fingerprint reader and provide a visual representation of the removal procedure.

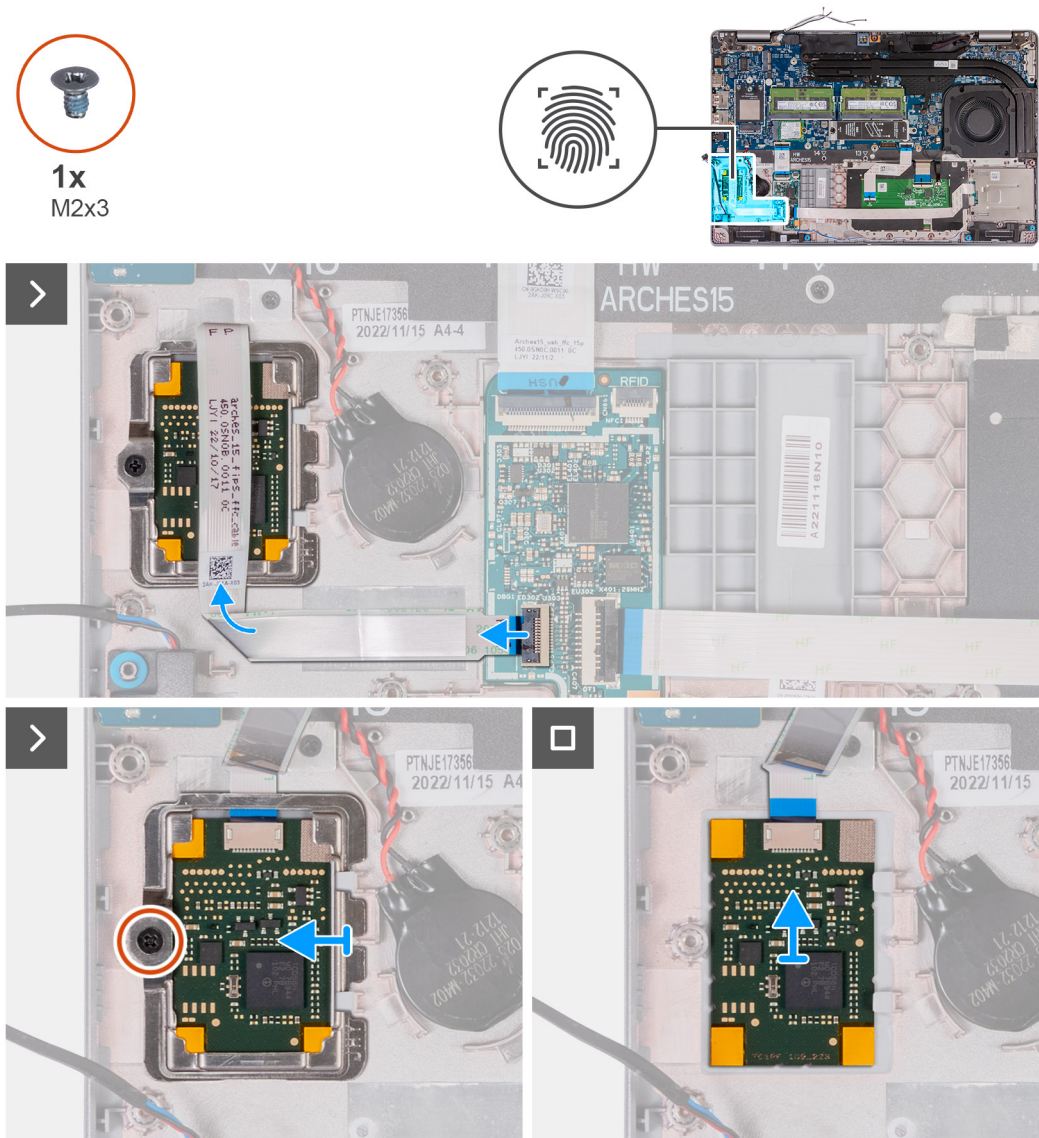

Figure 83. Image: Fingerprint reader

Steps

1. Lift the latch and disconnect the fingerprint-reader cable from the connector on the USH board.
2. Move the fingerprint-reader cable away from the fingerprint reader so that the cable is not covering the fingerprint reader.
3. Remove the screw (M2x3) that secures the fingerprint-reader bracket to the palm-rest assembly.
4. Slide and remove the fingerprint-reader bracket from the palm-rest assembly.
5. Lift the fingerprint reader, along with its cable, off the palm-rest assembly.

Installing the fingerprint reader (Optional)

CAUTION: The information in this section is intended for authorized service technicians only.

Prerequisites

If you are replacing a component, remove the existing component before performing the installation process.

About this task

The following images indicate the location of the fingerprint reader and provide a visual representation of the installation procedure.

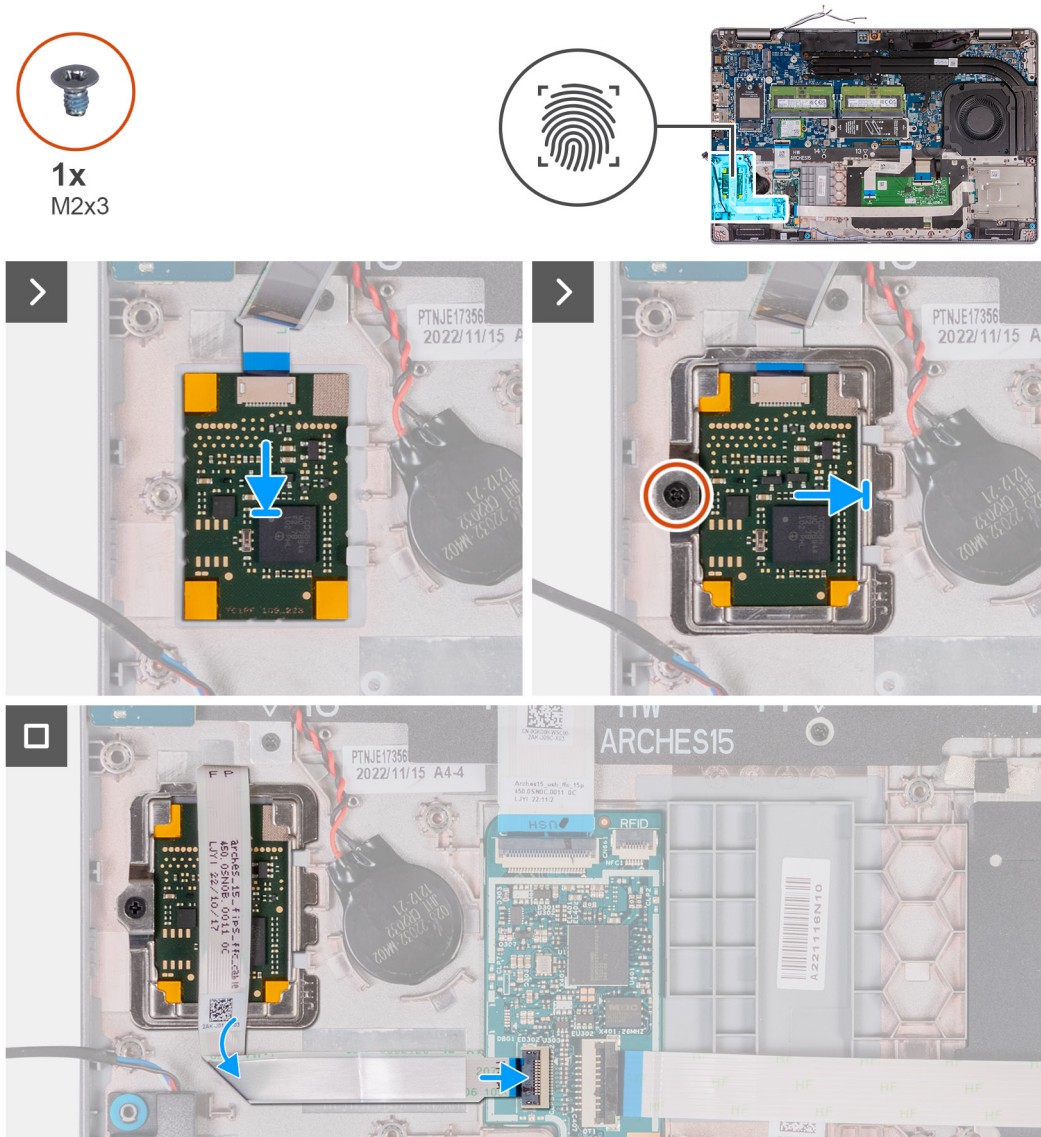

Figure 84. Image: Fingerprint reader

Steps

1. Align and place the fingerprint reader on its slot on the palm-rest assembly.
2. Slide the fingerprint-reader bracket on its slot on the palm-rest assembly.
3. Replace the screw (M2x3) that secures the fingerprint reader to the palm-rest assembly.
4. Connect the fingerprint-reader cable to the connector on the USH board and close the latch.

Next steps

1. Install the [assembly-inner frame](#).
2. Install the [battery](#).
3. Install the [base cover](#).
4. Install the [SIM card](#).
5. Follow the procedure in [After working inside your computer](#).

Smart-card reader

Removing the smart-card reader

CAUTION: The information in this section is intended for authorized service technicians only.

Prerequisites

1. Follow the procedure in [Before working inside your computer](#).
2. Remove the [SIM card](#).
3. Remove the [base cover](#).
4. Remove the [battery](#).
5. Remove the [assembly-inner frame](#).

About this task

The following image(s) indicate the location of the smart-card reader and provide a visual representation of the removal procedure.

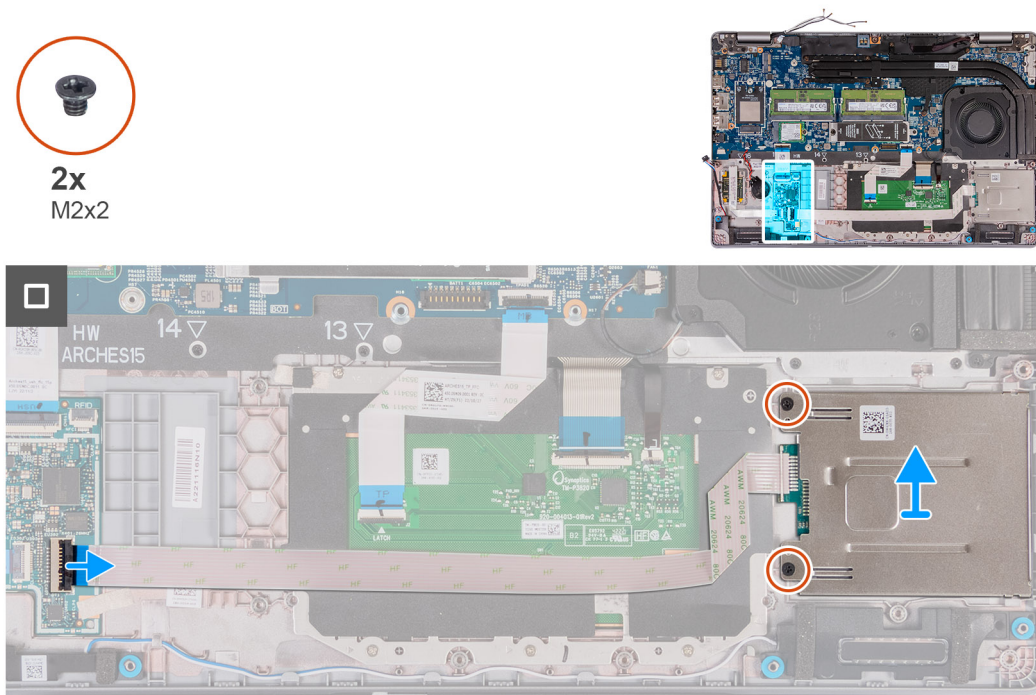

Figure 85. Image: Smart-card reader

Steps

1. Lift the latch and disconnect the smart-card reader cable from the connector on the USH board.
2. Remove the two screws (M2x2) that secure the smart-card reader to the palm-rest assembly.
3. Lift the smart-card reader, along with its cable, off the palm-rest assembly.

Installing the smart-card reader

CAUTION: The information in this section is intended for authorized service technicians only.

Prerequisites

If you are replacing a component, remove the existing component before performing the installation process.

About this task

The following images indicate the location of the smart card reader and provide a visual representation of the installation procedure.

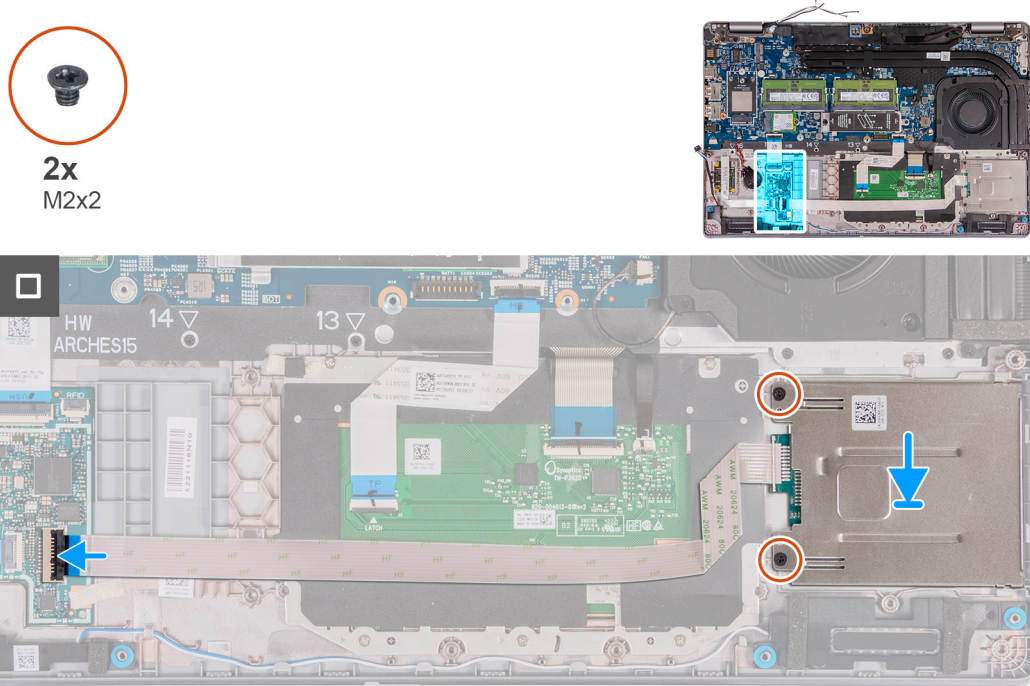

Figure 86. Image: Smart-card reader

Steps

1. Align and place the smart-card reader on its slot on the palm-rest assembly.
2. Replace the two screws (M2x2) that adheres the smart-card reader to the palm-rest assembly.
3. Connect the smart-card cable to the connector on the USH board and close the latch.

Next steps

1. Install the [assembly inner frame](#).
2. Install the [battery](#).
3. Install the [base cover](#).
4. Install the [SIM card](#).
5. Follow the procedure in [After working inside your computer](#).

Dummy SIM-card slot filler

Removing the dummy SIM-card slot filler

Prerequisites

1. Follow the procedure in [Before working inside your computer](#).
2. Remove the [SIM card](#).
3. Remove the [base cover](#).
4. Remove the [4G WWAN card](#) or [5G WWAN card](#), as applicable.
5. Remove the [WLAN card](#).

6. Remove the [memory modules](#).
7. Remove the [M.2 2230](#) or [M.2 2280](#) solid-state drive from Slot 1, as applicable.
8. Remove the [M.2 2230 solid-state drive from Slot 2](#), if applicable.
9. Remove the [battery](#).
10. Remove the [assembly-inner frame](#).
11. Remove the [system board](#).

NOTE: The system board can be removed with the heat sink attached in order to simplify the procedure and preserve the thermal bond between the system board and heat sink.

12. Remove the [display assembly](#).
13. Remove the [smart-card reader](#).
14. Remove the [fingerprint reader](#), if applicable.

About this task

NOTE: For models shipped with WLAN card only, the dummy SIM-card slot filler is a separate service part and is not included with replacement palm rest. As a result, the dummy SIM-card slot filler must be removed and then reinstalled when replacing the palm-rest assembly.

The following image indicates the dummy SIM-card slot filler and provides a visual representation of the dummy SIM-card slot filler removal procedure.

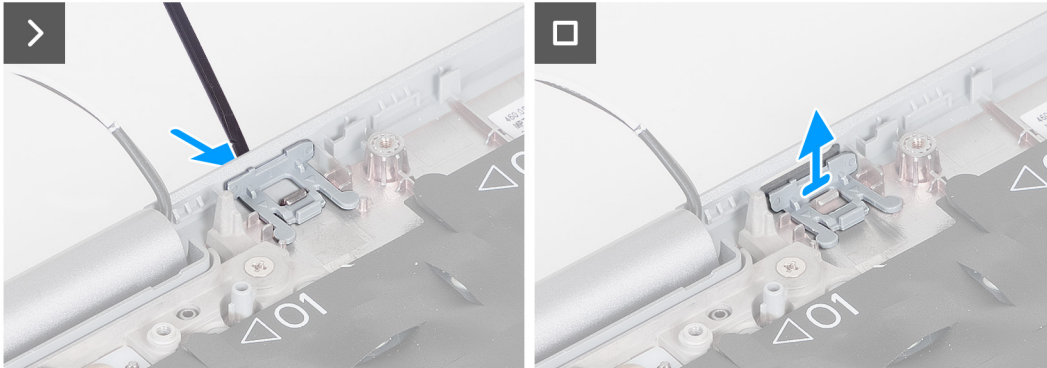
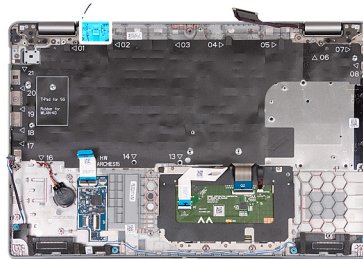

Steps

1. Using a scribe, push the dummy SIM-card slot filler from the top side of the palm-rest assembly.
2. Gently lift the dummy SIM-card slot filler out of the palm-rest assembly.

Installing the dummy SIM-card slot filler

Prerequisites

If you are replacing a component, remove the necessary component before the installation procedure.

About this task

The following image indicates the location of the dummy SIM-card slot filler and provides a visual representation of the dummy SIM-card slot filler installation procedure.

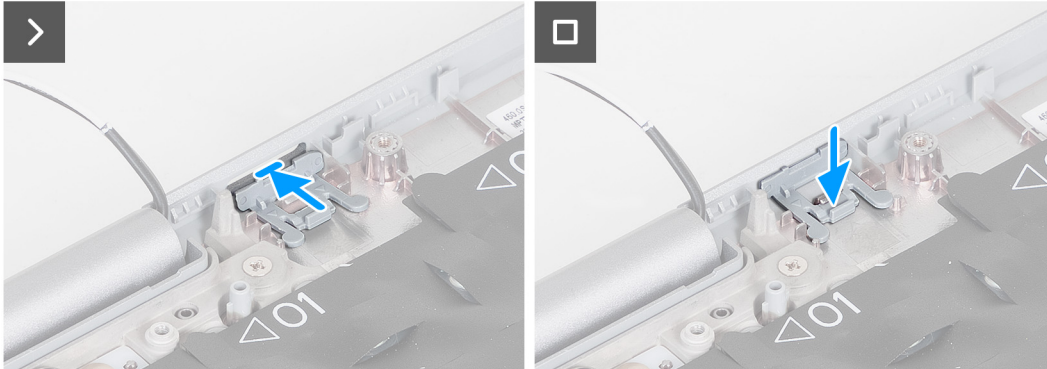
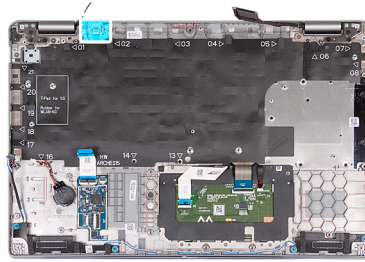

Steps

1. Place the dummy SIM-card slot filler into its compartment on the palm rest.
NOTE: Ensure that the dummy SIM-card slot filler is aligned with the ribs on the palm-rest assembly.
2. Press the dummy SIM-card slot filler until it clicks into place and ensure it fits securely into the SIM card slot.

Next steps

1. Install the [fingerprint reader](#), if applicable.
2. Install the [smart card reader](#).
3. Install the [display assembly](#).
4. Install the [system board](#).
5. Install the [assembly inner frame](#).
6. Install the [battery](#).
7. Install the [heat sink](#).
8. Install the [M.2 2230 solid-state drive in Slot 2](#), if applicable.
9. Install the [M.2 2230](#) or [M.2 2280](#) solid-state drive in Slot 1, as applicable.
10. Install the [memory modules](#).
11. Install the [WLAN card](#).
12. Install the [4G WWAN card](#) or [5G WWAN card](#), as applicable.
13. Install the [base cover](#).
14. Install the [SIM card](#).
15. Follow the procedure in [After working inside your computer](#).

Palm-rest assembly

Removing the palm-rest assembly

CAUTION: The information in this section is intended for authorized service technicians only.

Prerequisites

1. Follow the procedure in [Before working inside your computer](#).

2. Remove the [SIM card](#).
3. Remove the [base cover](#).
4. Remove the [4G WWAN card](#) or [5G WWAN card](#), as applicable.
5. Remove the [WLAN card](#).
6. Remove the [memory modules](#).
7. Remove the [M.2 2230](#) or [M.2 2280](#) solid-state drive from Slot 1, as applicable.
8. Remove the [M.2 2230 solid-state drive from Slot 2](#), if applicable.
9. Remove the [battery](#).
10. Remove the [assembly-inner frame](#).
11. Remove the [system board](#).

NOTE: The system board can be removed with the heat sink attached in order to simplify the procedure and preserve the thermal bond between the system board and heat sink.

12. Remove the [display assembly](#).
13. Remove the [smart-card reader](#), if applicable.
14. Remove the [fingerprint reader](#), if applicable.

About this task

NOTE: When replacing the palmrest assembly, transfer the dummy SIM filler to the new palmrest assembly.

The following images indicate the location of the palm-rest assembly and provide a visual representation of the removal procedure.

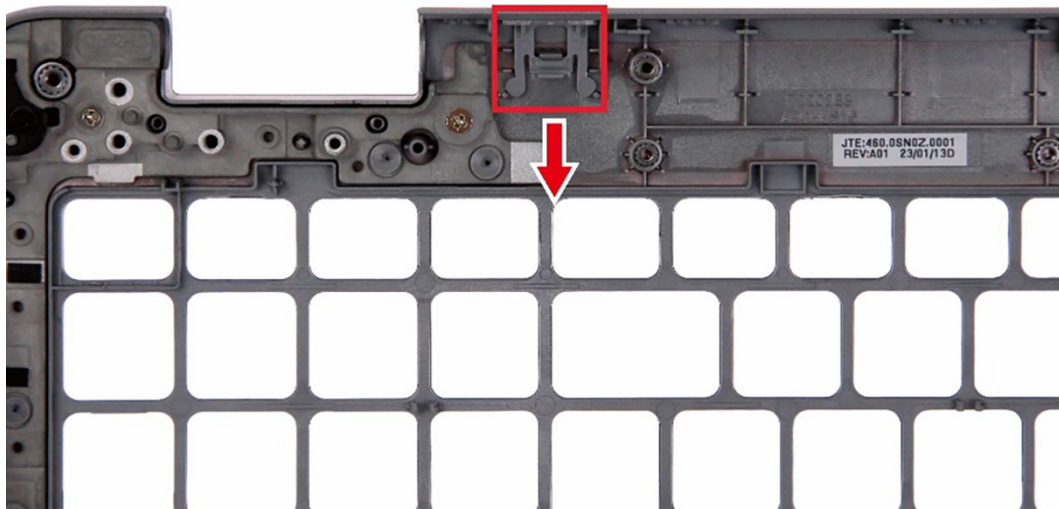

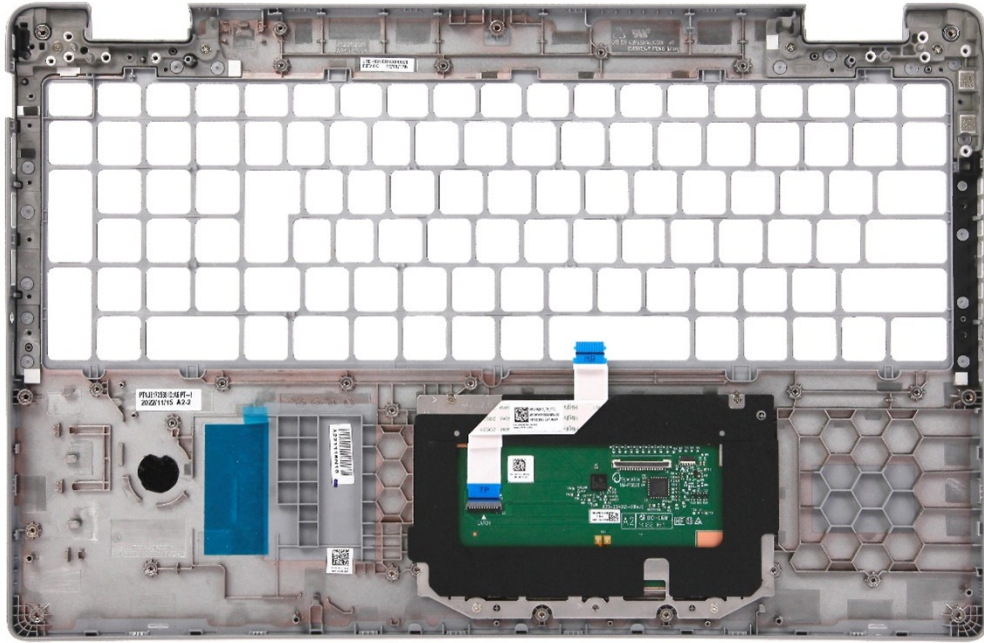

Figure 87. Image: Palm-rest assembly

Steps

After performing the steps in the pre-requisites, we are left with the palm-rest assembly.

Installing the palm-rest assembly

CAUTION: The information in this section is intended for authorized service technicians only.

Prerequisites

If you are replacing a component, remove the existing component before performing the installation process.

About this task

The following images indicate the location of the palm-rest assembly and provide a visual representation of the installation procedure.

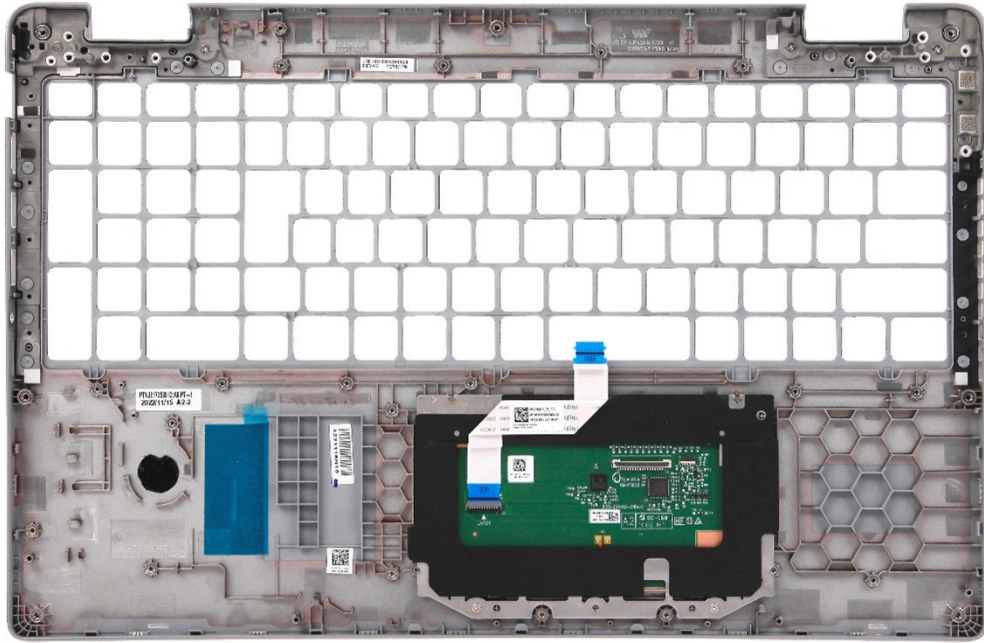

Figure 88. Image: Palm-rest assembly

Steps

Place the palm-rest assembly on a flat surface.

Next steps

1. Install the [fingerprint reader](#), if applicable.
2. Install the [smart card reader](#), if applicable.
3. Install the [display assembly](#).
4. Install the [system board](#).
5. Install the [assembly inner frame](#).
6. Install the [battery](#).
7. Install the [heat sink](#).
8. Install the [M.2 2230 solid-state drive in Slot 2](#), if applicable.
9. Install the [M.2 2230](#) or [M.2 2280 solid-state drive in Slot 1](#), as applicable.
10. Install the [memory modules](#).
11. Install the [WLAN card](#).
12. Install the [4G WWAN card](#) or [5G WWAN card](#), as applicable.
13. Install the [base cover](#).
14. Install the [SIM card](#).
15. Follow the procedure in [After working inside your computer](#).

Software

This chapter details the supported operating systems along with instructions on how to install the drivers.

Operating system

Your Latitude 5540 supports the following operating systems:

- Windows 11 Home, 64-bit
- Windows 11 Pro, 64-bit
- Windows 11 Pro downgrade (Win 10 Pro image FI + Win 11 Pro DPK)
- Ubuntu 22.04 LTS, 64-bit

Drivers and downloads

When troubleshooting, downloading, or installing drivers, it is recommended that you read the Dell Knowledge Base article [Drivers and Downloads FAQs 000123347](#).

BIOS Setup

CAUTION: Unless you are an expert computer user, do not change the settings in the BIOS Setup. Certain changes can make your computer work incorrectly.

NOTE: Depending on the computer and the installed devices, the options that are listed in this section may or may not be displayed.

NOTE: Before you change the settings in BIOS Setup, it is recommended that you note down the original settings for future reference.

Use BIOS Setup for the following purposes:

- Get information about the hardware installed in your computer, such as the amount of RAM and the size of the storage device.
- Change the system configuration information.
- Set or change a user-selectable option, such as the user password, type of hard drive installed, and enable or disable base devices.

Entering BIOS Setup program

About this task

Turn on (or restart) your computer and press F2 immediately.

Navigation keys

NOTE: For most of the BIOS Setup options, changes that you make are recorded but do not take effect until you restart the computer.

Table 36. Navigation keys

Keys	Navigation
Up arrow	Moves to the previous field.
Down arrow	Moves to the next field.
Enter	Selects a value in the selected field (if applicable) or follows the link in the field.
Spacebar	Expands or collapses a drop-down list, if applicable.
Tab	Moves to the next focus area.
Esc	Moves to the previous page until you view the main screen. Pressing Esc in the main screen displays a message that prompts you to save any unsaved changes and restart the computer.

F12 One Time Boot menu

To enter the One Time Boot menu, turn on your computer, and then press F12 immediately.

NOTE: If you are unable to enter the One Time Boot menu, repeat the above action.

The One Time Boot menu displays the devices that you can boot from and also display the options to start diagnostics. The boot menu options are:

- Removable Drive (if available)
- STXXXX Drive (if available)

NOTE: XXX denotes the SATA drive number.

- Optical Drive (if available)
- SATA Hard Drive (if available)
- Diagnostics

The One Time Boot menu screen also displays the option to access BIOS Setup.

System setup options

NOTE: Depending on your computer and its installed devices, the items listed in this section may or may not appear.

Table 37. System setup options—System information menu

Overview	
Latitude 5540	
BIOS Version	Displays the BIOS version number.
Service Tag	Displays the Service Tag of the computer.
Asset Tag	Displays the Asset Tag of the computer.
Manufacture Date	Displays the manufacture date of the computer.
Ownership Date	Displays the ownership date of the computer.
Express Service Code	Displays the express service code of the computer.
Ownership Tag	Displays the Ownership Tag of the computer.
Signed Firmware Update	Displays whether the Signed Firmware Update is enabled on your computer.
Battery Information	
Primary	Displays that battery is primary.
Battery Level	Displays the battery level of the computer.
Battery State	Displays the battery state of the computer.
Health	Displays the battery health of the computer.
AC Adapter	Displays whether the AC adapter is connected or not.
Battery Life Type	Displays the battery life type options such as Standard, Long Life Cycle 1.0, Long Life Cycle 2.0
Processor Information	
Processor Type	Displays the processor type.
Maximum Clock Speed	Displays the maximum processor clock speed.
Minimum Clock Speed	Displays the minimum processor clock speed.
Current Clock Speed	Displays the current processor clock speed.
Core Count	Displays the number of cores on the processor.
Processor ID	Displays the processor identification code.
Processor L2 Cache	Displays the processor L2 Cache size.
Processor L3 Cache	Displays the processor L3 Cache size.
Microcode Version	Displays the microcode version.

Table 37. System setup options—System information menu (continued)

Overview	
Intel Hyper-Threading Capable	Displays whether the processor is Hyper-Threading (HT) capable.
64-Bit Technology	Displays whether 64-bit technology is used.
Memory Information	
Memory Installed	Displays the total computer memory installed.
Memory Available	Displays the total computer memory available.
Memory Speed	Displays the memory speed.
Memory Channel Mode	Displays single or dual channel mode.
Memory Technology	Displays the technology used for the memory.
DIMM_SLOT B	Displays the DIMM B memory size.
DIMM_SLOT A	Displays the DIMM A memory size.
Devices Information	
Panel Type	Displays the Panel Type of the computer.
Video Controller	Displays the video controller type of the computer.
Video Memory	Displays the video memory information of the computer.
Wi-Fi Device	Displays the wireless device information of the computer.
Native Resolution	Displays the native resolution of the computer.
Video BIOS Version	Displays the video BIOS version of the computer.
Audio Controller	Displays the audio controller information of the computer.
Bluetooth Device	Displays the Bluetooth device information of the computer.
LOM MAC Address	Displays the LAN On Motherboard (LOM) MAC address of the computer.
Pass Through MAC Address	Displays the pass through MAC address of the computer.
Cellular Device	Displays the M.2 PCIe SSD information of the computer.
dGPU Video Controller	Displays the name of the discrete video controller.

Table 38. System setup options—Boot Configuration menu

Boot Configuration	
Boot Sequence	
Boot Mode: UEFI only	Displays the boot mode of this computer.
Boot Sequence	Enables to set the boot order.
Enable Secure Digital (SD) Card Boot	Enable or disable the SD card read-only boot. Default: Disabled
Secure Boot	
Enable Secure Boot	Enables secure boot using only validated boot software. Default: ON
Enable Microsoft UEFI CA	Enables Microsoft UEFI CA. Default: ON
Secure Boot Mode	Changes to the Secure Boot operation mode. Allows to switch between Deployed Mode and Audit Mode. Default: Deployed Mode
Expert Key Management	

Table 38. System setup options—Boot Configuration menu (continued)

Boot Configuration	
Enable Custom Mode	Allows the PK, KEK, db, and dbx security key databases to be modified. Default: OFF
Custom Mode Key Management	Allows for selection of key database.

Table 39. System setup options—Integrated Devices menu

Integrated Devices	
Date/Time	Displays the current date in MM/DD/YYYY format and current time in HH:MM:SS AM/PM format.
Camera	Enables or disable the camera. By default, the Enable Camera option is selected
Audio	
Enable Audio	Enable or disable the integrated audio controller. By default, all the options are enabled.
Enable Microphone	Enables or disables microphone. By default, Enable Microphone is selected.
Enable Internal Speaker	Enables or disables internal speaker. By default, Enable Internal Speaker is selected.
USB/Thunderbolt Configuration	<ul style="list-style-type: none"> • Enable or disable booting from USB mass storage devices connected to external USB ports. By default, the Enable External USB Ports option is enabled. • Enable or disable booting from USB mass storage devices such as external hard drive, optical drive, and USB drive. By default, the Enable USB Boot Support option is enabled.
Enable Thunderbolt Technology Support	Enable or disable the associated ports and adapters. By default, the Enable Thunderbolt Technology Support option is selected.
Enable Thunderbolt Boot Support	Enable or disable the Thunderbolt adapter peripheral device and USB devices connected to the Thunderbolt adapter to be used during BIOS Pre-boot. By default, the Enable Thunderbolt Boot Support option is disabled.
Enable Thunderbolt (and PCIe behind TBT) pre-boot modules	Enable or disable the PCIe devices that are connected through a Thunderbolt adapter to execute the PCIe devices UEFI Option ROM (if present) during pre-boot. By default, the Enable Thunderbolt (and PCIe behind TBT) pre-boot modules option is disabled.
Disable USB4 PCIE Tunneling	Disable the USB4 PCIE Tunneling option. By default, the option is disabled.
Video/Power only on Type-C Ports	Enable or disable the Type-C port functionality to video or only power. By default, the Video/Power only on Type-C Ports option is disabled.
Type-C Dock Override	Enables to use connected Type-C Dell Dock to provide data stream with external USB ports disabled. When Type-C Dock override is enabled, the Video/Audio/Lan submenu is activated. By default, the Type-C Dock Override option is enabled.
Video	Enable or disable the usage of video on Dell Dock external ports.

Table 39. System setup options—Integrated Devices menu (continued)

Integrated Devices	
	By default, the Video option is disabled.
Audio	Enable or disable the usage of audio on Dell Dock external ports. By default, the Audio option is enabled.
Lan	Enable or disable the usage of LAN on Dell Dock external ports. By default, the Lan option is enabled.
Miscellaneous Devices	Enable or disable Fingerprint Reader device. By default, the Enable Fingerprint Reader Device option is enabled.
Unobtrusive Mode	
Enable Unobtrusive Mode	Enable or disable all the computer light and sound. By default, the Enable Unobtrusive Mode option is not enabled.

Table 40. System setup options—Storage menu

Storage	
SATA Operation	
SATA Operation	Set the operating mode of the integrated storage device controller. By default, the RAID On option is enabled.
Storage Interface	
SATA Operation	Enable or disable the onboard drives on the computer. The following options is available (ON by default): <ul style="list-style-type: none"> • M.2 PCIe SSD-1 • M.2 PCIe SSD-2
SMART Reporting	
Enable SMART Reporting	Enable or disable Self-Monitoring, Analysis, and Reporting Technology (SMART) during computer startup. By default, the Enable SMART Reporting option is not enabled.
Drive Information	Displays the drive type and device name.
Enable MediaCard	
Secure Digital (SD) Card	Enable or disable the SD card. By default, the Secure Digital (SD) Card option is enabled.
Secure Digital (SD) Card Read-Only Mode	Enable or disable the SD card read-only mode. By default, the Secure Digital (SD) Card Read-Only Mode option is not enabled.

Table 41. System setup options—Display menu

Display	
Display Brightness	
Brightness on battery power	Enable to set screen brightness when the computer is running on battery power.
Brightness on AC power	Enable to set screen brightness when the computer is running on AC power.
Full Screen Logo	Enable or disable full screen logo. By default, the option is not enabled.

Table 41. System setup options—Display menu (continued)

Display	
Touchscreen	Enable or disable the touchscreen for the operating system. By default, the option is enabled.

Table 42. System setup options—Connection menu

Connection	
Network Controller Configuration	
Integrated NIC	Controls the on-board LAN controller. By default, the Enabled with PXE option is enabled.
Enable UEFI Network Stack	Enable or disable UEFI Network Stack. By default, the Enable UEFI Network Stack and Enabled w/PXE option are enabled.
Wireless Device Enable	
WWAN/GPS	Enable or disable the internal WWAN/GPS device By default, the option is enabled.
WLAN	Enable or disable the internal WLAN device By default, the option is enabled.
Bluetooth	Enable or disable the internal Bluetooth device By default, the option is enabled.
Contactless smartcard/NFC	Enable or disable the internal Contactless smartcard/NFC device By default, the option is enabled.
Enable UEFI Network Stack	Enable or disable UEFI Network Stack and controls the on-board LAN Controller. By default, the Enable UEFI Network Stack option are enabled.
Wireless Radio Control	
Control WLAN radio	Sense the connection of the computer to a wired network and subsequently disable the selected wireless radios (WLAN). By default, the option is disabled.
Control WWAN radio	Sense the connection of the computer to a wired network and subsequently disable the selected wireless radios (WWAN). By default, the option is disabled.
HTTPs Boot Feature	
HTTPs Boot	Enable or disable the HTTPs Boot feature. By default, the HTTPs Boot option is enabled.
HTTPs Boot Mode	With Auto Mode, the HTTPs Boot extracts Boot URL from the DHCP. With Manual Mode, the HTTPs Boot reads Boot URL from the user-provided data. By default, the Auto Mode option is enabled.
Boot URL	Displays the Boot URL The default value is NULL.
Boot Certificate	Displays the Boot certificate The default value is NULL.

Table 43. System setup options—Power menu

Power	
<p>Battery configuration</p>	<p>Enables the computer to run on battery during peak power usage hours. Use the table Custom Charge Start and Custom Charge Stop, to prevent AC power usage between certain times of each day.</p> <p>By default, the Adaptive option is enabled.</p>
<p>Advanced Configuration</p> <p>Enable Advanced Battery Charge Configuration</p>	<p>Enable or disable the advanced battery charge configuration.</p> <p>By default, the Enable Advanced Battery Charge Configuration option is disabled.</p>
<p>Peak Shift</p> <p>Enable Peak Shift</p>	<p>Enables the computer to run on battery during peak power usage hours.</p> <p>By default, the Enable Peak Shift option is enabled.</p>
<p>Type-C Connector Power</p>	<p>Enables you to select the applicable wattage.</p>
<p>USB PowerShare</p> <p>Enable USB PowerShare</p>	<p>Enable or disable the USB PowerShare.</p> <p>By default, the Enable USB PowerShare option is disabled</p>
<p>Thermal Management</p>	<p>Enables to cool the fan and processor heat management to adjust the computer performance, noise, and temperature.</p> <p>By default, the Optimized option is enabled.</p>
<p>USB Wake Support</p> <p>Wake on Dell USB-C Dock</p>	<p>When enabled, connecting a Dell USB-C Dock will wake the computer from standby.</p> <p>By default, the Wake on Dell USB-C Dock option is enabled.</p>
<p>Block Sleep</p>	<p>Enables to block entering sleep (S3) mode in the operating system.</p> <p>By default, the Block Sleep option is disabled.</p>
<p>Lid Switch</p>	<p>Enable or disable the lid switch.</p> <p>By default, the Lid Switch option is enabled.</p>
<p>Intel Speed Shift Technology</p>	<p>Enable or disable the Intel speed shift technology support.</p> <p>By default, the Intel Speed Shift Technology option is enabled.</p>

Table 44. System setup options—Security menu

Security	
<p>TPM 2.0 Security</p> <p>TPM 2.0 Security On</p>	<p>Enable or disable TPM 2.0 security options.</p> <p>By default, the TPM 2.0 Security On option is enabled.</p>
<p>Attestation Enable</p>	<p>Enables to control whether the Trusted Platform Module (TPM) Endorsement Hierarchy is available to the operating system.</p> <p>By default, the Attestation Enable option is enabled.</p>
<p>Key Storage Enable</p>	<p>Enables to control whether the Trusted Platform Module (TPM) Storage Hierarchy is available to the operating system.</p> <p>By default, the Key Storage Enable option is enabled.</p>

Table 44. System setup options—Security menu (continued)

Security	
SHA-256	<p>BIOS and the TPM will use the SHA-256 hash algorithm to extend measurements into the TPM PCRs during BIOS boot.</p> <p>By default, the SHA-256 option is enabled.</p>
Clear	<p>Enables to clear the TPM owner information and returns the TPM to the default state.</p> <p>By default, the Clear option is disabled.</p>
PPI ByPass for Clear Commands	<p>Controls the TPM Physical Presence Interface (PPI).</p> <p>By default, the PPI ByPass for clear Commands option is disabled.</p>
Intel Total Memory Encryption	
Total Memory Encryption	<p>Enable or disable you to protect memory from physical attacks including freeze spray, probing DDR to read the cycles, and others.</p> <p>By default, the Total Memory Encryption option is disabled.</p>
Chassis intrusion	
	<p>Controls the chassis intrusion feature.</p> <p>By default, the On-Silent option is enabled.</p>
SMM Security Mitigation	
	<p>Enable or disable SMM Security Mitigation.</p> <p>By default, the option is enabled.</p>
Data Wipe on Next Boot	
Start Data Wipe	<p>Enable or disable the data wipe on next boot.</p> <p>By default, the option is enabled.</p>
Absolute	<p>Enable or disable or permanently disable the BIOS module interface of the optional Absolute Persistence Module service from Absolute software.</p> <p>By default, the option is enabled.</p>
UEFI Boot Path Security	<p>Controls whether or not the computer will prompt the user to enter the admin password (if set) when booting to a UEFI boot device from the F12 boot menu.</p> <p>By default, the Always Except Internal HDD option is enabled.</p>
Authenticated BIOS Interface	
Enable Authenticated BIOS Interface	By default, this option is disabled.
Clear Certificate Store	By default, this option is disabled.
Firmware Device Tamper Detection	
	<p>Enables you to control the firmware device tamper detection feature. This feature notifies the user when the firmware device is tampered. When enabled, a screen warning messages are displayed on the computer and a tamper detection event is logged in the BIOS Events log. The computer fails to reboot until the event is cleared.</p> <p>By default, the Firmware Device Tamper Detection option is set to Silent.</p> <p>For additional security, Dell Technologies recommends keeping the Firmware Device Tamper Detection option enabled.</p>
Clear Firmware Device Tamper Detection	By default, this option is disabled.

Table 45. System setup options—Passwords menu

Passwords	
Admin Password	Set, change, or delete the administrator password.
System Password	Set, change, or delete the computer password.

Table 45. System setup options—Passwords menu (continued)

Passwords	
M.2 PCIe SSD-1	Set, change, or delete the SSD-1 password.
M.2 PCIe SSD-2	Set, change, or delete the SSD-2 password.
Password Configuration	
Upper Case Letter	Reinforces password must have at least one upper case letter. By default, the option is disabled.
Lower Case Letter	Reinforces password must have at least one lower case letter. By default, the option is disabled.
Digit	Reinforces password must have at least one digit. By default, the option is disabled.
Special Character	Reinforces password must have at least one special character. By default, the option is disabled.
Minimum Characters	Set the minimum characters allowed for password.
Password Bypass	When enabled, this always prompts for computer and internal hard drive passwords when powered on from the off state. By default, the Disabled option is enabled.
Password Changes	
Enable Non-Admin Password Changes	Enable or disable to change computer and hard drive password without the need for admin password. By default, the option is enabled.
Admin Setup Lockout	
Enable Admin Setup Lockout	Enables administrators control over how their users can or cannot access BIOS setup. By default, the option is disabled.
Master Password Lockout	
Enable Master Password Lockout	When enabled, this will disable the master password support. By default, the option is disabled.
Allow Non-Admin PSID Revert	
Enable Allow Non-Admin PSID Revert	Controls access to the Physical Security ID (PSID) revert of NVMe hard-drives from the Dell Security Manager prompt. By default, the option is disabled.

Table 46. System setup options—Update, Recovery menu

Update, Recovery	
UEFI Capsule Firmware Updates	Enable or disable BIOS updates through UEFI capsule update packages. By default, the option is enabled.
BIOS Recovery from Hard Drive	Enables the user to recover from certain corrupted BIOS conditions from a recovery file on the user primary hard drive or an external USB key. By default, the option is enabled.
BIOS Downgrade	

Table 46. System setup options—Update, Recovery menu (continued)

Update, Recovery	
Allow BIOS Downgrade	<p>Enable or disable the flashing of the computer firmware to previous revision is blocked.</p> <p>By default, the option is enabled.</p>
SupportAssist OS Recovery	<p>Enable or disable the boot flow for SupportAssist OS Recovery tool in the event of certain computer errors.</p> <p>By default, the option is enabled.</p>
BIOSConnect	<p>Enable or disable cloud Service OS recovery if the main operating system fails to boot with the number of failures equal to or greater than the value specified by the Auto OS Recovery Threshold setup option and local Service OS does not boot or is not installed.</p> <p>By default, the option is enabled.</p>
Dell Auto OS Recovery Threshold	<p>Controls the automatic boot flow for SupportAssist System Resolution Console and for Dell OS Recovery Tool.</p> <p>By default, the threshold value is set to 2.</p>

Table 47. System setup options—System Management menu

System Management	
Service Tag	Display the Service Tag of the computer.
Asset Tag	Create a computer Asset Tag.
AC Behavior	
Wake on AC	<p>Enable or disable the wake on AC option.</p> <p>By default, the option is disabled.</p>
Wake on LAN	
Wake on LAN	<p>Enable or disable the computer to power on by special LAN signals when it receives a wakeup signal from the WLAN.</p> <p>By default, the Disabled option is selected.</p>
Auto on Time	<p>Enable to set the computer to turn on automatically every day or on a preselected date and time. This option can be configured only if the Auto On Time is set to Everyday, Weekdays, or Selected Days.</p> <p>By default, the option is disabled.</p>
Intel AMT Capability	
Enable Intel AMT Capability	<p>Enable or disable Intel AMT capability.</p> <p>By default, this option is set to Restrict Preboot Access.</p>
First Power On Date	
Set Ownership Date	<p>Enables to set the ownership date.</p> <p>By default, this option is disabled.</p>
Diagnostics	
OS Agent Requests	<p>Enables or disables scheduling of onboard diagnostics on the subsequent boot.</p> <p>By default, this option is enabled.</p>
Power-on-Self-Test Automatic Recovery	<p>Enables or disables automatic recovery if the computer is unresponsive after the BIOS Power-on-Self Test.</p> <p>By default, this option is enabled.</p>

Table 48. System setup options—Keyboard menu

Keyboard	
Numlock Enable	Enable or disable the Numlock function when the computer boots. By default, the option is enabled.
Fn Lock Options	By default, the Fn lock option is enabled.
Keyboard Illumination	Enables to change the keyboard illumination settings. By default, the Bright option is enabled.
Keyboard Backlight Timeout on AC	Set the timeout value for the keyboard backlight when an AC adapter is connected to the computer. By default, the 10 seconds option is enabled.
Keyboard Backlight Timeout on Battery	Set the timeout value for the keyboard backlight when the is running only on battery power. By default, the 10 seconds option is enabled.
Device Configuration Hotkey Access	Manages whether you can access device configuration screens through hotkeys during computer startup. By default, the option is enabled.

Table 49. System setup options—Pre-boot Behavior menu

Pre-boot Behavior	
Adapter Warnings	Enable Adapter Warnings Enable or disable the warning messages during boot when the adapters with less power capacity are detected. By default, the option is enabled.
Warning and Errors	Enable or disable the action to be done when a warning or error is encountered. By default, the Prompt on Warnings and Errors option is enabled.
Fastboot	Enable to set the speed of the boot process. By default, the Minimal option is enabled.
Extend BIOS POST Time	Set the BIOS POST time. By default, the 0 seconds option is enabled.
MAC Address Pass-Through	Replaces the external NIC MAC address with the selected MAC address from the computer. By default, the System Unique MAC Address option is enabled.
Sign of Life	Early Keyboard Backlight By default, the option is enabled.

Table 50. System setup options—Virtualization menu

Virtualization	
Intel Virtualization Technology	Enable Intel Virtualization Technology (VT) When enabled, the system can run a Virtual Machine Monitor (VMM). Default: ON
VT for Direct I/O	Enable Intel VT for Direct I/O When enabled, the system can perform Virtualization Technology for Direct I/O (VT-d).

Table 50. System setup options—Virtualization menu (continued)

Virtualization	
	Default: ON
DMA Protection	
Enable Pre-Boot DMA Support	This setting controls Pre-boot DMA protection for both internal and external ports. Default: ON
Enable OS Kernel DMA Support	This setting controls Kernel DMA protection for both internal and external ports. Default: ON

Table 51. System setup options—Performance menu

Performance	
Multi Core Support	
Active Cores	Enables to change the number of CPU cores available to the operating system. By default, the All Cores options is enabled.
Intel SpeedStep	
Enable Intel SpeedStep Technology	Enables the computer to dynamically adjust processor voltage and core frequency, decreasing average power consumption and heat production. By default, the option is enabled.
C-States Control	
Enable C-State Control	Enable or disable additional processor sleep states. By default, the option is enabled.
Intel TurbocBoost Technology	
Enable Intel Turbo Boost Technology	Enable or disable Intel TurboBoost mode of the processor. By default, the option is enabled.
Intel Hyper-Threading Technology	
Enable Intel Hyper-Threading Technology	Enable or disable Hyper-Threading in the processor. By default, the option is enabled.

Table 52. System setup options—System Logs menu

System Logs	
BIOS Event Log	
Clear Bios Event Log	Display BIOS events. By default, the Keep option is enabled.
Thermal Event Log	
Clear Thermal Event Log	Display Thermal events. By default, the Keep option is enabled.
Power Event Log	
Clear Power Event Log	Display power events. By default, the Keep option is enabled.

Updating the BIOS

Updating the BIOS in Windows

About this task

 **CAUTION:** If BitLocker is not suspended before updating the BIOS, the next time you reboot the computer it will not recognize the BitLocker key. You will then be prompted to enter the recovery key to progress, and the computer will ask for this on each reboot. If the recovery key is not known this can result in data loss or an unnecessary operating system reinstall. For more information about this subject, search in the Knowledge Base Resource at [Dell Support Site](#).

Steps

1. Go to [Dell Support Site](#).
2. Click **Product support**. In the **Search support** box, enter the Service Tag of your computer, and then click **Search**.
 **NOTE:** If you do not have the Service Tag, use the SupportAssist to automatically identify your computer. You can also use the product ID or manually browse for your computer model.
3. Click **Drivers & Downloads**. Expand **Find drivers**.
4. Select the operating system installed on your computer.
5. In the **Category** drop-down list, select **BIOS**.
6. Select the latest version of BIOS, and click **Download** to download the BIOS file for your computer.
7. After the download is complete, browse the folder where you saved the BIOS update file.
8. Double-click the BIOS update file icon and follow the on-screen instructions.
For more information, search in the Knowledge Base Resource at [Dell Support Site](#).

Updating the BIOS in Linux and Ubuntu

To update the system BIOS on a computer that is installed with Linux or Ubuntu, see the knowledge base article [000131486](#) at [Dell Support Site](#).

Updating the BIOS using the USB drive in Windows

About this task

 **CAUTION:** If BitLocker is not suspended before updating the BIOS, the next time you reboot the computer it will not recognize the BitLocker key. You will then be prompted to enter the recovery key to progress, and the computer will ask for this on each reboot. If the recovery key is not known this can result in data loss or an unnecessary operating system reinstall. For more information about this subject, search in the Knowledge Base Resource at [Dell Support Site](#).

Steps

1. Follow the procedure from step 1 to step 6 in [Updating the BIOS in Windows](#) to download the latest BIOS setup program file.
2. Create a bootable USB drive. For more information, search in the Knowledge Base Resource at [Dell Support Site](#).
3. Copy the BIOS setup program file to the bootable USB drive.
4. Connect the bootable USB drive to the computer that needs the BIOS update.
5. Restart the computer and press **F12**.
6. Select the USB drive from the **One Time Boot Menu**.
7. Type the BIOS setup program filename and press **Enter**.
The **BIOS Update Utility** appears.
8. Follow the on-screen instructions to complete the BIOS update.

Updating the BIOS from the One-Time boot menu

Update your computer BIOS using the BIOS XXXX.exe file that is copied to a FAT32 USB drive and booting from the One-Time boot menu.

About this task

CAUTION: If BitLocker is not suspended before updating the BIOS, the next time you reboot the computer it will not recognize the BitLocker key. You will then be prompted to enter the recovery key to progress, and the computer will ask for this on each reboot. If the recovery key is not known this can result in data loss or an unnecessary operating system reinstall. For more information about this subject, search in the Knowledge Base Resource at [Dell Support Site](#).

BIOS Update

You can run the BIOS flash update file from Windows using a bootable USB drive or you can also update the BIOS from the One-Time boot menu on the computer.

You can confirm by booting your computer to the **One Time Boot** Menu to see if BIOS FLASH UPDATE is listed as a boot option. If the option is listed, then the BIOS can be updated using this method.

Updating from the One-Time boot menu

To update your BIOS from the One-Time boot menu, you need the following:

- USB drive formatted to the FAT32 file system (the drive does not have to be bootable)
- BIOS executable file that you downloaded from the Dell Support website and copied to the root of the USB drive
- AC power adapter must be connected to the computer
- Functional computer battery to flash the BIOS

Perform the following steps to perform the BIOS flash update process from the One-Time boot menu:

CAUTION: Do not turn off the computer during the BIOS flash update process. The computer may not boot if you turn off your computer.

Steps

1. Turn off your computer, insert the USB drive where you copied the BIOS flash update file into a USB port of the computer.
2. Turn on the computer and press to access the **One Time Boot** Menu. Select BIOS Update using the mouse or arrow keys then press Enter.
The flash BIOS menu is displayed.
3. Click **Flash from file**.
4. Select the external USB device.
5. Select the file and double-click the flash target file, and then click **Submit**.
6. Click **Update BIOS**. The computer restarts to flash the BIOS.
7. The computer will restart after the BIOS flash update is completed.

System and setup password

Table 53. System and setup password

Password type	Description
System password	Password that you must enter to log in to your system.
Setup password	Password that you must enter to access and make changes to the BIOS settings of your computer.

You can create a system password and a setup password to secure your computer.

CAUTION: The password features provide a basic level of security for the data on your computer.

CAUTION: Anyone can access the data that is stored on your computer, when left unattended.

 **NOTE:** System and setup password feature is disabled.

Assigning a System Setup password

Prerequisites

You can assign a new System or Admin Password only when the status is in **Not Set**.

About this task

To enter BIOS System Setup, press F2 immediately after a power-on or reboot.

Steps

1. In the **System BIOS** or **System Setup** screen, select **Security** and press Enter.
The **Security** screen is displayed.
2. Select **System/Admin Password** and create a password in the **Enter the new password** field.
Use the following guidelines to assign the system password:
 - A password can have up to 32 characters.
 - At least one special character: "(! " # \$ % & ' * + , - . / : ; < = > ? @ [\] ^ _ ` { | })"
 - Numbers 0 to 9.
 - Upper case letters from A to Z.
 - Lower case letters from a to z.
3. **Confirm new password** type the system password that you entered earlier in the field and click **OK**.
4. Press Esc and save the changes as prompted by the message.
5. Press Y to save the changes.
The computer restarts.

Deleting or changing an existing system password or setup password

Prerequisites

Ensure that the **Password Status** is Unlocked (in the System Setup) before attempting to delete or change the existing system password and/or setup password. You cannot delete or change an existing system password or setup password if the **Password Status** is Locked.

About this task

To enter the System Setup, press F2 immediately after a power-on or reboot.

Steps

1. In the **System BIOS** or **System Setup** screen, select **System Security** and press Enter.
The **System Security** screen is displayed.
2. In the **System Security** screen, verify that the **Password Status** is Unlocked.
3. Select **System Password**. Update or delete the existing system password, and press Enter or Tab.
4. Select **Setup Password**. Update or delete the existing setup password, and press Enter or Tab.
 **NOTE:** If you change the system password and/or setup password, reenter the new password when prompted. If you delete the system password and/or setup password, confirm the deletion when prompted.
5. Press Esc. A message prompts you to save the changes.
6. Press Y to save the changes and exit from **System Setup**.
The computer restarts.

Clearing CMOS settings

About this task

 **CAUTION:** Clearing CMOS settings will reset the BIOS settings on your computer.

Steps

1. Remove the [base cover](#).
2. Disconnect the battery cable from the system board.
3. Remove the [coin-cell battery](#).
4. Wait for one minute.
5. Replace the [coin-cell battery](#).
6. Connect the battery cable to the system board.
7. Replace the [base cover](#).

Clearing BIOS (System Setup) and System passwords

About this task

To clear the computer or BIOS passwords, contact Dell technical support as described at [Contact Support](#). For more information, go to [Dell Support Site](#).

 **NOTE:** For information about how to reset Windows or application passwords, see the documentation accompanying Windows or your application.

Troubleshooting

Handling swollen rechargeable Li-ion batteries

Like most laptops, Dell laptops use Lithium-ion batteries. One type of Lithium-ion battery is the rechargeable Li-ion battery. Rechargeable Li-ion batteries have increased in popularity in recent years and have become a standard in the electronics industry due to customer preferences for a slim form factor (especially with newer ultra-thin laptops) and long battery life. Inherent to rechargeable Li-ion battery technology is the potential for swelling of the battery cells.

A swollen battery may impact the performance of the laptop. To prevent possible further damage to the device enclosure or internal components leading to malfunction, discontinue the use of the laptop and discharge it by disconnecting the AC adapter and letting the battery drain.

Swollen batteries should not be used and must be replaced and disposed of properly. We recommend contacting Dell Support for options to replace a swollen battery under the terms of the applicable warranty or service contract, including options for replacement by a Dell authorized service technician.

The guidelines for handling and replacing rechargeable Li-ion batteries are as follows:

- Exercise caution when handling rechargeable Li-ion batteries.
- Discharge the battery before removing it from the computer. To discharge the battery, unplug the AC adapter from the computer and operate the computer only on battery power. The battery is fully discharged when the computer no longer turns on when the power button is pressed.
- Do not crush, drop, mutilate, or penetrate the battery with foreign objects.
- Do not expose the battery to high temperatures, or disassemble battery packs and cells.
- Do not apply pressure to the surface of the battery.
- Do not bend the battery.
- Do not use tools of any type to pry on or against the battery.
- If a battery gets stuck in a device as a result of swelling, do not try to free it as puncturing, bending, or crushing a battery can be dangerous.
- Do not attempt to reassemble a damaged or swollen battery into a laptop.
- Swollen batteries that are covered under warranty should be returned to Dell in an approved shipping container (provided by Dell)—this is to comply with transportation regulations. Swollen batteries that are not covered under warranty should be disposed of at an approved recycling center. Contact Dell Support at [Dell Support Site](#) for assistance and further instructions.
- Using a non-Dell or incompatible battery may increase the risk of fire or explosion. Replace the battery only with a compatible battery purchased from Dell that is designed to work with your Dell computer. Do not use a battery from other computers with your computer. Always purchase genuine batteries from [Dell Site](#) or otherwise directly from Dell.

Rechargeable Li-ion batteries can swell for various reasons such as age, number of charge cycles, or exposure to high heat. For more information about how to improve the performance and lifespan of the laptop battery and to minimize the possibility of occurrence of the issue, search Dell laptop battery in the Knowledge Base Resource at [Dell Support Site](#).

Locating the Service Tag or Express Service Code of your Dell computer

Your Dell computer is uniquely identified with a Service Tag or Express Service Code. To view relevant support resources for your Dell computer, we recommend entering the Service Tag or Express Service Code at [Dell Support Site](#).

For more information about how to find the Service Tag for your computer, see [Instructions on how to find your Service Tag or Serial Number](#).

Dell SupportAssist Pre-boot System Performance Check diagnostics

About this task

SupportAssist diagnostics (also known as system diagnostics) performs a complete check of your hardware. The Dell SupportAssist Pre-boot System Performance Check diagnostics is embedded with the BIOS and launched by the BIOS internally. The embedded system diagnostics provides options for particular devices or device groups allowing you to:

- Run tests automatically or in an interactive mode.
- Repeat the tests.
- Display or save test results.
- Run thorough tests to introduce additional test options to provide extra information about one or more failed devices.
- View status messages that inform you the tests are completed successfully.
- View error messages that inform you of problems encountered during testing.

 **NOTE:** Some tests for specific devices require user interaction. Always ensure that you are present at the computer when the diagnostic tests are performed.

For more information, see the knowledge base article [000180971](#).

Running the SupportAssist Pre-Boot System Performance Check

Steps

1. Turn on your computer.
2. As the computer boots, press the F12 key as the Dell logo appears.
3. On the boot menu screen, select the **Diagnostics** option.
4. Click the arrow at the bottom left corner.
Diagnostics page is displayed.
5. Click the arrow in the lower-right corner to go to the page listing.
The items that are detected are listed.
6. To run a diagnostic test on a specific device, press Esc and click **Yes** to stop the diagnostic test.
7. Select the device from the left pane and click **Run Tests**.
8. If there are any issues, error codes are displayed.
Note the error code and validation number and contact Dell.

Built-in self-test (BIST)

M-BIST

M-BIST (Built In Self-Test) is the system board built-in self-test diagnostics tool that improves the diagnostics accuracy of system board Embedded Controller (EC) failures.

 **NOTE:** M-BIST can be manually initiated before Power On Self-Test (POST).

How to run M-BIST

 **NOTE:** Before initiating M-BIST, ensure that the computer is in a power-off state.

1. Press and hold both the **M** key on the keyboard and the power button to initiate M-BIST.
2. The battery indicator LED may exhibit two states:
 - a. OFF: No fault was detected with the system board.
 - b. AMBER: Amber indicates a problem with the system board.
3. If there is a failure with the system board, the battery status LED flashes one of the following error codes for 30 seconds:

Table 54. LED error codes

Blinking Pattern		Possible Problem
Amber	White	
2	1	CPU Failure
2	8	LCD Power Rail Failure
1	1	TPM Detection Failure
2	4	Memory/RAM failure

4. If there is no failure with the system board, the LCD cycles through the solid color screens that are described in the LCD-BIST section for 30 seconds and then turn off.

LCD Power rail test (L-BIST)

L-BIST is an enhancement to the single LED error code diagnostics and is automatically initiated during POST. L-BIST will check the LCD power rail. If there is no power being supplied to the LCD (that is if the L-BIST circuit fails), the battery status LED flashes either an error code [2,8] or an error code [2,7].

 **NOTE:** If L-BIST fails, LCD-BIST cannot function as no power will be supplied to the LCD.

How to invoke the L-BIST

1. Turn on your computer computer.
2. If the computer does not start up normally, look at the battery status LED:
 - If the battery status LED flashes an error code [2,7], the display cable may not be connected properly.
 - If the battery status LED flashes an error code [2,8], there is a failure on the LCD power rail of the system board, hence there is no power that is supplied to the LCD.
3. For cases, when a [2,7] error code is shown, check to see if the display cable is properly connected.
4. For cases when a [2,8] error code is shown, replace the system board.

LCD Built-in Self-Test (BIST)

Dell laptops have a built-in diagnostic tool that helps you determine if the screen abnormality you are experiencing is an inherent problem with the LCD (screen) of the Dell laptop or with the video card (GPU) and computer settings.

When you notice screen abnormalities like flickering, distortion, clarity issues, fuzzy or blurry image, horizontal or vertical lines, color fade and so on, it is always a good practice to isolate the LCD (screen) by running the Built-In Self-Test (BIST).

How to invoke the LCD BIST

1. Turn off your computer.
2. Disconnect any peripherals that are connected to the computer. Connect only the AC adapter (charger) to the computer.
3. Ensure that the LCD (screen) is clean (no dust particles on the surface of the screen).
4. Press and hold the **D** key and press the power button to enter LCD built-in self-test (BIST) mode. Continue to hold the **D** key until the computer boots up.
5. The screen displays solid colors and change colors on the entire screen to white, black, red, green, and blue twice.
6. Then it displays the colors white, black, and red.
7. Carefully inspect the screen for abnormalities (any lines, fuzzy color, or distortion on the screen).
8. At the end of the last solid color (red), the computer shuts down.

 **NOTE:** Dell SupportAssist Preboot diagnostics upon launch initiates an LCD BIST first, expecting a user intervention to confirm functionality of the LCD.

System-diagnostic lights

Power and battery-status light

The power and battery-status light indicates the power and battery status of the computer. These are the power states:

Solid white:Power adapter is connected and the battery has more than 5% charge.

Amber:Computer is running on battery and the battery has less than 5% charge.

Off:

- Power adapter is connected, and the battery is fully charged.
- Computer is running on battery, and the battery has more than 5% charge.
- Computer is in sleep state, hibernation, or turned off.

The power and battery-status light may blink amber or white according to pre-defined "beep codes" indicating various failures.

For example, the power and battery-status light blinks amber two times followed by a pause, and then blinks white three times followed by a pause. This 2,3 pattern continues until the computer is turned off, indicating no memory or RAM is detected.

The following table shows different power and battery-status light patterns and associated problems.

i NOTE: The following diagnostic light codes and recommended solutions are intended for Dell service technicians to troubleshoot problems. You should only perform troubleshooting and repairs as authorized or directed by the Dell technical assistance team. Damage due to servicing that is not authorized by Dell is not covered by your warranty.

Table 55. Diagnostic-light LED codes

Diagnostic light codes (Amber,White)	Problem description
1,1	TPM detection failure
1,2	Unrecoverable SPI Flash Failure
1,3	Short in hinge cable tripped OCP1
1,4	Short in hinge cable tripped OCP2
1,5	EC unable to program i-Fuse
1,6	Generic catch-all for ungraceful EC code flow errors
1,7	Non-RPMC flash on boot guard fused system
2,1	Processor failure
2,2	System board: BIOS or Read-Only Memory (ROM) failure
2,3	No memory or Random-Access Memory (RAM) detected
2,4	Memory or Random-Access Memory (RAM) failure
2,5	Invalid memory installed
2,6	System-board or chipset error
2,7	Display failure - SBIOS message
3,1	Coin-cell battery failure
3,2	PCI, video card/chip failure
3,3	Recovery image not found
3,4	Recovery image found but invalid
3,5	Power-rail failure
3,6	System BIOS Flash incomplete
3,7	Management Engine (ME) error

Recovering the operating system

When your computer is unable to boot to the operating system even after repeated attempts, it automatically starts Dell SupportAssist OS Recovery.

Dell SupportAssist OS Recovery is a stand-alone tool that is preinstalled in Dell computers running Windows operating system. It consists of tools to diagnose and troubleshoot issues that may occur before your computer boots to the operating system. It enables you to diagnose hardware issues, repair your computer, back up your files, or restore your computer to its factory state.

You can also download it from the Dell Support website to troubleshoot and fix your computer when it fails to boot into the primary operating system due to software or hardware failures.

For more information about the Dell SupportAssist OS Recovery, see *Dell SupportAssist OS Recovery User's Guide at Serviceability Tools at the Dell Support Site*. Click **SupportAssist** and then, click **SupportAssist OS Recovery**.

Real-Time Clock (RTC Reset)

The Real-Time Clock (RTC) reset function enables you or the service technician to recover Dell computers from No POST/No Power/No Boot situations. The legacy jumper enabled RTC reset has been retired on these models.

Start the RTC reset with the computer powered off and connected to AC power. Press and hold the power button for twenty seconds . The computer RTC Reset occurs after you release the power button.

Backup media and recovery options

It is recommended to create a recovery drive to troubleshoot and fix problems that may occur with Windows. Dell provides multiple options for recovering the Windows operating system on your Dell computer. For more information, see [Dell Windows Backup Media and Recovery Options](#).

Wi-Fi power cycle

About this task

If your computer is unable to access the Internet due to Wi-Fi connectivity issues, reset your Wi-Fi device by performing the following steps:

Steps

1. Turn off the computer.
2. Turn off the modem.
 **NOTE:** Some Internet service providers (ISPs) provide a modem and router combo device.
3. Turn off the wireless router.
4. Wait for 30 seconds.
5. Turn on the wireless router.
6. Turn on the modem.
7. Turn on the computer.

Drain residual flea power (perform hard reset)

About this task

Flea power is the residual static electricity that remains in the computer even after it has been powered off and the battery is removed.

For your safety, and to protect the sensitive electronic components in your computer, you must drain residual flea power before removing or replacing any components in your computer.

Draining residual flea power, also known as a performing a "hard reset," is also a common troubleshooting step if your computer does not turn on or boot into the operating system.

Perform the following steps to drain the residual flea power:

Steps

1. Turn off the computer.
2. Disconnect the power adapter from the computer.
3. Remove the base cover.
4. Remove the battery.



CAUTION: The battery is a Field Replaceable Unit (FRU) and the removal and installation procedures are intended for authorized service technicians only.

5. Press and hold the power button for 20 seconds to drain the flea power.
6. Install the battery.
7. Install the base cover.
8. Connect the power adapter to the computer.
9. Turn on the computer.



NOTE: For more information about performing a hard reset, search in the Knowledge Base Resource at the [Dell Support Site](#).

Getting help and contacting Dell

Self-help resources

You can get information and help on Dell products and services using these self-help resources:

Table 56. Self-help resources

Self-help resources	Resource location
Information about Dell products and services	Dell Site
Tips	
Contact Support	In Windows search, type <code>Contact Support</code> , and press Enter.
Online help for operating system	Windows Support Site Linux Support Site
Access top solutions, diagnostics, drivers and downloads, and learn more about your computer through videos, manuals, and documents.	Your Dell computer is uniquely identified using a Service Tag or Express Service Code. To view relevant support resources for your Dell computer, enter the Service Tag or Express Service Code at Dell Support Site . For more information about how to find the Service Tag for your computer, see Locate the Service Tag on your computer .
Dell knowledge base articles	<ol style="list-style-type: none"> 1. Go to Dell Support Site. 2. On the menu bar at the top of the Support page, select Support > Support Library. 3. In the Search field on the Support Library page, type the keyword, topic, or model number, and then click or tap the search icon to view the related articles.

Contacting Dell

To contact Dell for sales, technical support, or customer service issues, see [Dell Support Site](#).

 **NOTE:** Availability of the services may vary depending on the country or region, and product.

 **NOTE:** If you do not have an active Internet connection, you can find contact information about your purchase invoice, packing slip, bill, or Dell product catalog.