

dji MAVIC 3 / MAVIC 3 V2.0

User Manual v2.0 2022.12

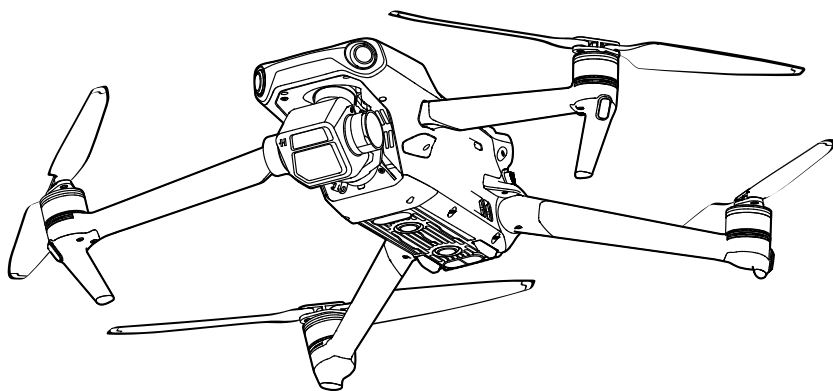

Searching for Keywords

Search for keywords such as “battery” and “install” to find a topic. If you are using Adobe Acrobat Reader to read this document, press Ctrl+F on Windows or Command+F on Mac to begin a search.

Navigating to a Topic

View a complete list of topics in the table of contents. Click on a topic to navigate to that section.

Printing this Document

This document supports high resolution printing.

Revision Log

Version	Date	Revisions
v1.2	2021.12	Added Intelligent Flight Mode section.
v1.4	2022.1	Updated Smart RTH, added QuickShots, QuickTransfer and USB Mode features.
v1.6	2022.5	Updated Tele Camera features, etc.
v1.8	2022.11	Added new features such as Cruise Control, Night mode, etc. Added support for EU C1 certification and RID in the United States.
v2.0	2022.12	Added Waypoint Flight.

Using this Manual

Legend

 Important

 Hints and Tips

 Reference

Read Before the First Flight

Read the following documents before using the DJI™ MAVIC™ 3:

1. Safety Guidelines
2. Quick Start Guide
3. User Manual

It is recommended to watch all tutorial videos on the official DJI website and read safety guidelines before using for the first time. Prepare for your first flight by reviewing the quick start guide and refer to this user manual for more information.

Video Tutorials

Go to the address below or scan the QR code to watch the DJI Mavic 3 tutorial videos, which demonstrate how to use the Mavic 3 safely:

MAVIC 3



<https://s.dji.com/ZGppl5>

MAVIC 3 CINE



<https://s.dji.com/ZGppl4>

Download the DJI Fly App

Make sure to use DJI Fly during flight. Scan the QR code above to download the latest version.

-  • The DJI RC Pro remote controller has the DJI Fly app already installed. Users are required to download DJI Fly to their mobile device when using DJI RC-N1 remote controller.
- The Android version of DJI Fly is compatible with Android v6.0 and later. The iOS version of DJI Fly is compatible with iOS v11.0 and later.

* For increased safety, flight is restricted to a height of 98.4 ft (30 m) and range of 164 ft (50 m) when not connected or logged into the app during flight. This applies to DJI Fly and all apps compatible with DJI aircraft.

Download DJI Assistant 2 (Consumer Drones Series)

Download DJI Assistant 2 (Consumer Drones Series) at <http://www.dji.com/mavic-3/downloads>.

-  • The operating temperature of this product is -10° to 40° C. It does not meet the standard operating temperature for military grade application (-55° to 125° C), which is required to endure greater environmental variability. Operate the product appropriately and only for applications that it meets the operating temperature range requirements of that grade.

Contents

Using this Manual	2
Legend	2
Read Before the First Flight	2
Video Tutorials	2
Download the DJI Fly App	2
Download DJI Assistant 2 (Consumer Drones Series)	2
Product Profile	6
Introduction	6
Using for the First Time	7
Diagram	9
Aircraft	14
Flight Modes	14
Aircraft Status Indicators	15
Return to Home	16
Vision Systems and Infrared Sensing System	21
Intelligent Flight Mode	23
Advanced Pilot Assistance Systems (APAS 5.0)	35
Flight Recorder	35
QuickTransfer	36
Propellers	37
Intelligent Flight Battery	38
Gimbal and Camera	43
Remote Controller	46
DJI RC Pro	46
RC-N1	54
Linking the Remote Controller	58
DJI Fly App	60
Home	60
Camera View	61

Flight	66
Flight Environment Requirements	66
Operating the Aircraft Responsibly	66
Flight Limits and GEO Zones	67
Pre-Flight Checklist	68
Auto Takeoff/Landing	69
Starting/Stopping the Motors	69
Flight Test	70
Appendix	72
Specifications	72
Firmware Update	77
Troubleshooting Procedures	78
Risk and Warnings	78
Disposal	79
C1 Certification	79
FAR Remote ID Compliance Information	83
After-Sales Information	83

Product Profile

This section introduces DJI Mavic 3 and lists the components of the aircraft and remote controller.

Product Profile

Introduction

DJI Mavic 3 features both an Infrared Sensing System and Forward, Backward, Upward, Lateral, and Downward Vision Systems, allowing for hovering and flying indoors as well as outdoors and for automatic Return to Home while avoiding obstacles in all directions. The aircraft has a maximum flight speed of 47 mph (75.6 kph) and a maximum flight time of 46 minutes.

The DJI RC Pro remote controller has a built-in 5.5-in high brightness 1000cd/m² screen with a resolution of 1920x1080 pixels. Users can connect to the internet via Wi-Fi while the Android operating system includes Bluetooth and GNSS. The DJI RC Pro comes with a wide range of aircraft and gimbal controls as well as customizable buttons and has a maximum operating time of 3 hours. The RC-N1 remote controller displays the video transmission from the aircraft to DJI Fly on a mobile device. The aircraft and camera are easy to control using the onboard buttons and the remote controller has a runtime of 6 hours.

Feature Highlights

Gimbal and Camera: DJI Mavic 3 uses a 4/3-in CMOS sensor Hasselblad L2D-20c camera, capable of shooting 20MP photos and 5.1K 50fps/DCI 4K 120fps Apple ProRes 422 HQ* and H.264/H.265 videos. The camera has an adjustable aperture of f/2.8 to f/11, a dynamic range of 12.8 stops, and supports 10-bit D-Log video. The tele camera helps users to capture up to 28x zoom using Explore mode.

Video Transmission: With four built-in antennas and DJI's long-range transmission O3+ technology, DJI Mavic 3 offers a maximum transmission range of 15 km and video quality at up to 1080p 60fps from the aircraft to the DJI Fly app. The remote controller works at both 2.4 and 5.8 GHz, and is capable of selecting the best transmission channel automatically.

Intelligent Flight Modes: The user can focus on operating the aircraft while the Advanced Pilot Assistance System 5.0 (APAS 5.0) helps the aircraft to avoid obstacles in all directions.

* Only the DJI Mavic 3 Cine/DJI Mavic 3 Cine V2.0 aircraft comes with a built-in 1TB SSD, which supports the recording and storing of Apple ProRes video. There are some requirements and restrictions when using Mavic 3 V2.0 and Mavic 3 Cine V2.0 in EU since they are comply with C1 certification. Otherwise, The features and functions described in this manual apply to DJI Mavic 3/Mavic 3 V2.0 and DJI Mavic 3 Cine/Mavic 3 Cine V2.0.



- The maximum flight time was tested in an environment without wind while flying at a consistent flight speed of 20.1 mph (32.4 kph). The maximum flight speed was tested at sea level altitude without wind. Note that the maximum flight speed is limited to 42 mph (68.4 kph) in the European Union (EU). These value are for reference only.
- The remote controller reaches its maximum transmission distance (FCC) in a wide-open area with no electromagnetic interference at an altitude of about 400 ft (120 m). The maximum transmission distance refers to the maximum distance that the aircraft can still send and receive transmissions. It does not refer to the maximum distance the aircraft can fly in a single flight. The maximum runtime was tested in a laboratory environment and without charging the mobile device. This value is for reference only.
- 5.8 GHz is not supported in some regions. Observe the local laws and regulations.
- DJI RC-N1, DJI RC Pro remote controller, and all types of ND filters are fully compatible with Mavic 3.

Using for the First Time

DJI Mavic 3 is folded before being packaged. Follow the steps below to unfold the aircraft and remote controller.

Preparing the Aircraft

1. Remove the storage cover.

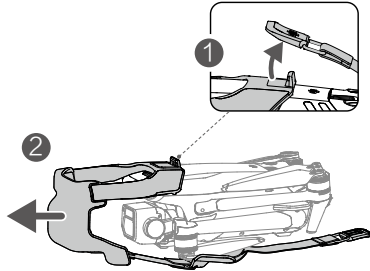

2. All Intelligent Flight Batteries are in hibernation mode before delivery to ensure safety. Use the provided charger to charge and activate the Intelligent Flight Batteries for the first time. It takes approximately 1 hour and 36 minutes to fully charge an Intelligent Flight Battery. Charging time is tested when using the fixed cable of the charger. It is recommended to use this cable to charge the Intelligent Flight Battery.

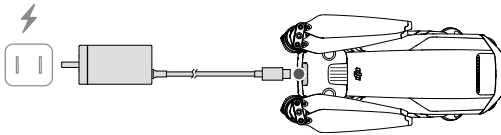

3. Unfold the front arms, followed by the rear arms, and then the propeller blades.

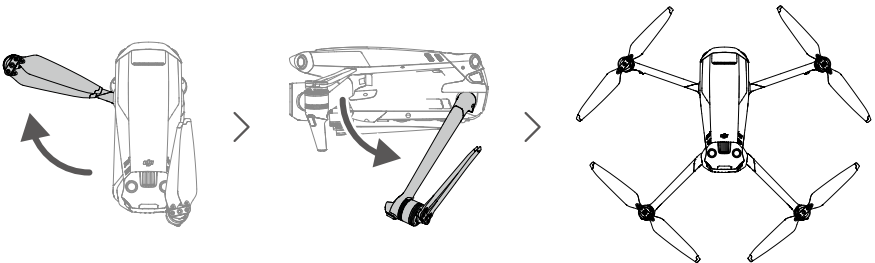

- Make sure to unfold the front arms before unfolding the rear arms.
- Make sure the storage cover is removed and all arms are unfolded before powering on the aircraft. Otherwise, it may affect the aircraft self-diagnostics.
- Attach the storage cover when the aircraft is not in use.

Preparing the Remote Controller

Follow the steps below to prepare to use the DJI RC Pro remote controller.

1. Use the provided charger to charge the remote controller via the USB-C port to activate the battery.

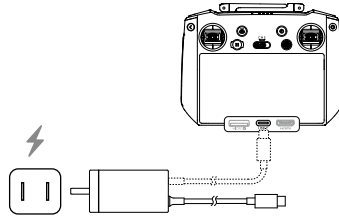

2. Remove the control sticks from the storage slots on the remote controller and screw them into place.
3. Unfold the antennas.
4. The remote controller needs to be activated before using for the first time and an internet connection is required for activation. Press and then press and hold the power button to power on the remote controller. Follow the on-screen prompts to activate the remote controller.

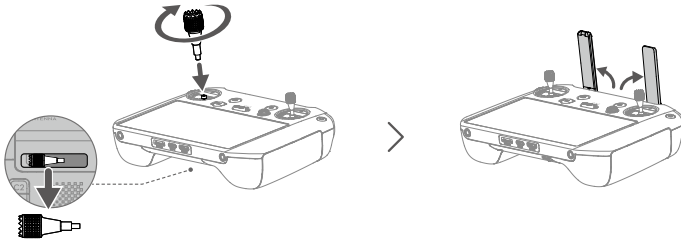

Follow the steps below to prepare the DJI RC-N1 remote controller.

1. Remove the control sticks from their storage slots on the remote controller and screw them into place.
2. Pull out the mobile device holder. Choose an appropriate remote controller cable based on the type of mobile device. A Lightning connector cable, Micro USB cable, and USB-C cable are included in the packaging. Connect the end of the cable with the phone icon to your mobile device. Make sure the mobile device is secured.

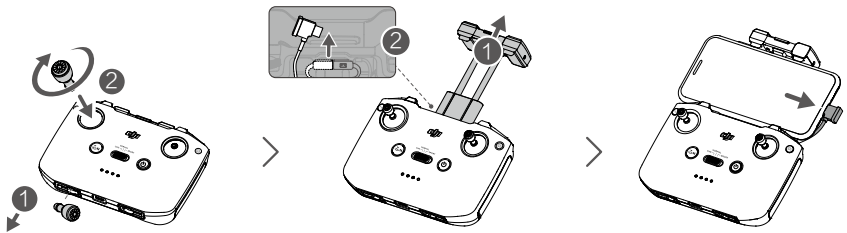

• If a USB connection prompt appears when using an Android mobile device, select the option to charge only. Otherwise, it may fail to connect.

Activating DJI Mavic 3 Aircraft

DJI Mavic 3 requires activation before using for the first time. After powering on the aircraft and remote controller, follow the on-screen prompts to activate DJI Mavic 3 using DJI Fly. An internet connection is required for activation.

Binding the Aircraft and Remote Controller

It is recommended to bind the aircraft and remote controller to help ensure the best possible after-sales service. Follow the on-screen prompts after activation to bind the aircraft and remote controller.

Updating Firmware

A prompt will appear in DJI Fly when new firmware is available. It is recommended to update the firmware whenever prompted to do so in order to ensure the best possible user experience.

Diagram

Aircraft

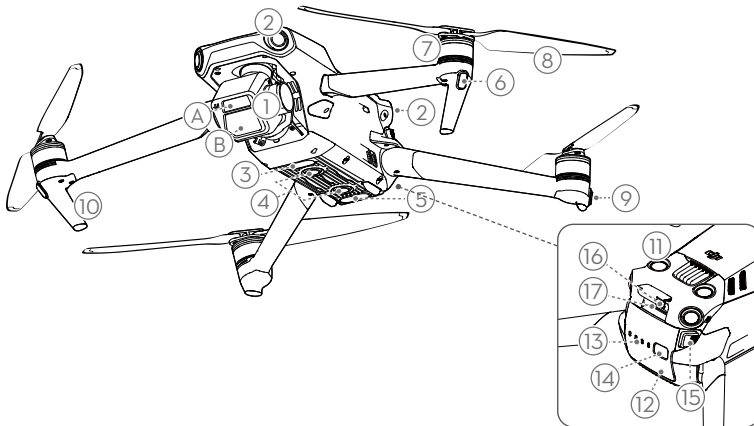

- | | |
|---|---------------------------------------|
| 1. Gimbal and Camera | 9. Aircraft Status Indicators |
| A. Tele Camera | 10. Landing Gears (Built-in antennas) |
| B. Hasselblad L2D-20c Camera | 11. Upward Vision System |
| 2. Horizontal Omnidirectional Vision System | 12. Intelligent Flight Battery |
| 3. Auxiliary Bottom Light | 13. Battery Level LEDs |
| 4. Downward Vision System | 14. Power Button |
| 5. Infrared Sensing System | 15. Battery Buckles |
| 6. Front LEDs | 16. USB-C Port |
| 7. Motors | 17. microSD Card Slot |
| 8. Propellers | |

DJI RC Pro

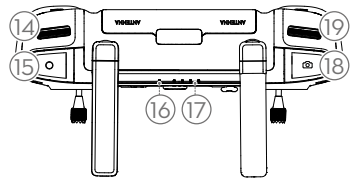
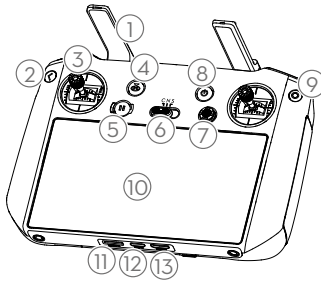

- 1. Antennas**
Relay aircraft control and video wireless signals.
- 2. Back Button**
Press once to return to the previous screen. Press twice to return to the home screen.
- 3. Control Sticks**
Use the control sticks to control the aircraft movements. Set the flight control mode in DJI Fly. The control sticks are removable and easy to store.
- 4. Return to Home (RTH) Button**
Press and hold to initiate RTH. Press again to cancel RTH.
- 5. Flight Pause Button**
Press once to make the aircraft brake and hover in place (only when GNSS or Vision Systems are available).
- 6. Flight Mode Switch**
Switch between Cine, Normal, and Sport mode.
- 7. 5D Button**
View the 5D Button features in DJI Fly by entering Camera View, Settings, and then Control.
- 8. Power Button**
Press once to check the current battery level. Press and then press and hold to power the remote controller on or off. When the remote controller is powered on, press once to turn the touchscreen on or off.
- 9. Confirm Button**
Press once to confirm a selection. The button does not have a function when using DJI Fly.
- 10. Touchscreen**
Touch the screen to operate the remote controller. Note that the touchscreen is not waterproof. Operate with caution.
- 11. microSD Card Slot**
Use to insert a microSD card.
- 12. USB-C port**
For charging.
- 13. Mini HDMI Port**
For video output.
- 14. Gimbal Dial**
Controls the tilt of the camera.
- 15. Record Button**
Press once to start or stop recording.
- 16. Status LED**
Indicates the status of remote controller.
- 17. Battery Level LEDs**
Displays the current battery level of the remote controller.
- 18. Focus/Shutter Button**
Press halfway down on the button to auto focus and press all the way down to take a photo.
- 19. Camera Control Dial**
For zoom control.

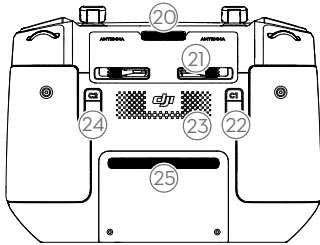

20. Air Vent

Used for heat dissipation. Do not block the air vent during usage.

21. Control Sticks Storage Slot

For storing the control sticks.

22. Customizable C1 Button

Switch between recentering the gimbal and pointing the gimbal downward. The function can be set in DJI Fly.

23. Speaker

Outputs sound.

24. Customizable C2 Button

Press once to turn the Auxiliary Bottom Light on or off. The function can be set in DJI Fly.

25. Air Intake

Used for heat dissipation. DO NOT cover the air intake during use.

RC-N1

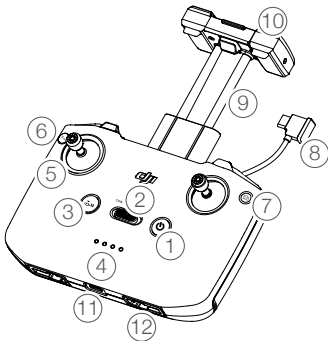

1. Power Button

Press once to check the current battery level. Press once, then again, and hold to power the remote controller on or off.

2. Flight Mode Switch

Switch between Sport, Normal, and Cine mode.

3. Flight Pause/Return to Home (RTH) Button

Press once to make the aircraft brake and hover in place (only when GNSS or Vision Systems are available). Press and hold the button to initiate RTH. Press again to cancel RTH.

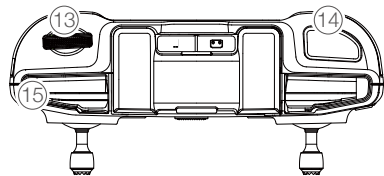

4. Battery Level LEDs

Displays the current battery level of the remote controller.

5. Control Sticks

Use the control sticks to control the aircraft movements. Set the flight control mode in DJI Fly. The control sticks are removable and easy to store.

6. Customizable Button

Press once to turn the Auxiliary Bottom Light on or off. Press twice to recenter the gimbal or tilt the gimbal downward (default settings). The button can be set in DJI Fly.

7. Photo/Video Toggle

Press once to switch between photo and video mode.

8. Remote Controller Cable

Connect to a mobile device for video linking via the remote controller cable. Select the cable according to the mobile device.

9. Mobile Device Holder

Used to securely mount the mobile device to the remote controller.

10. Antennas

Relay aircraft control and video wireless signals.

11. USB-C Port

For charging and connecting the remote controller to the computer.

12. Control Sticks Storage Slot

For storing the control sticks.

13. Gimbal Dial

Controls the tilt of the camera. Press and hold the customizable button to use the gimbal dial to adjust the zoom in Explore Mode.

14. Shutter/Record Button

Press once to take photos or start or stop recording.

15. Mobile Device Slot

Used to secure the mobile device.

Aircraft

DJI Mavic 3 contains a flight controller, video downlink system, vision systems, infrared sensing system, propulsion system, and an Intelligent Flight Battery.

Aircraft

DJI Mavic 3 contains a flight controller, video downlink system, vision systems, infrared sensing system, propulsion system, and an Intelligent Flight Battery.

Flight Modes

DJI Mavic 3 has three flight modes, plus a fourth flight mode that the aircraft switches to in certain scenarios. Flight modes can be switched via the Flight Mode switch on the remote controller.

Normal Mode: The aircraft utilizes GNSS and the Forward, Backward, Lateral, Upward, and Downward Vision Systems and Infrared Sensing System to locate and stabilize itself. When the GNSS signal is strong, the aircraft uses GNSS to locate and stabilize itself. When the GNSS is weak but the lighting and other environment conditions are sufficient, the aircraft uses the vision systems to locate and stabilize itself. When the Forward, Backward, Lateral, Upward, and Downward Vision Systems are enabled and lighting and other environment conditions are sufficient, the maximum tilt angle is 30° and the maximum flight speed is 15 m/s.

Sport Mode: In Sport Mode, the aircraft uses GNSS for positioning and the aircraft responses are optimized for agility and speed making it more responsive to control stick movements. Note that obstacle sensing is disabled and the maximum flight speed is 21 m/s (19 m/s when flying in the EU).

Cine Mode: Cine mode is based on Normal mode and the flight speed is limited, making the aircraft more stable during shooting.

The aircraft automatically changes to Attitude (ATTI) mode when the Vision Systems are unavailable or disabled and when the GNSS signal is weak or the compass experiences interference. In ATTI mode, the aircraft may be more easily affected by its surroundings. Environmental factors such as wind can result in horizontal shifting, which may present hazards, especially when flying in confined spaces.



- The Forward, Backward, Lateral, and Upward Vision Systems are disabled in Sport mode, which means the aircraft cannot sense obstacles on its route automatically.
 - The maximum speed and braking distance of the aircraft significantly increase in Sport mode. A minimum braking distance of 30 m is required in windless conditions.
 - A minimum braking distance of 10 m is required in windless conditions while the aircraft is ascending and descending.
 - The responsiveness of the aircraft significantly increases in Sport mode, which means a small control stick movement on the remote controller translates into the aircraft moving a large distance. Make sure to maintain adequate maneuvering space during flight.
-

Aircraft Status Indicators



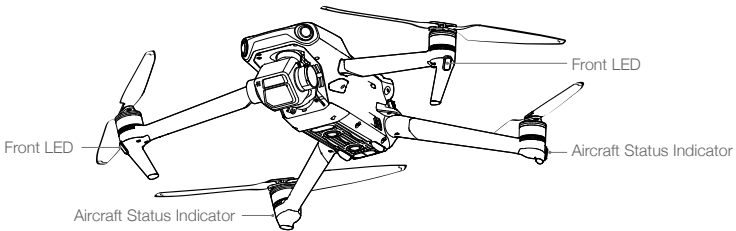







DJI Mavic 3 has front LEDs and aircraft status indicators.



When the aircraft is powered on but the motors are not running, the front LEDs glow solid red to display the orientation of the aircraft.

When the aircraft is powered on but the motors are not running, the aircraft status indicators display the status of the flight control system. Refer to the table below for more information about the aircraft status indicators.

Aircraft Status Indicator States



Normal States			
	Alternating red, green, and yellow	Blinks	Turning on and performing self-diagnostic tests
	Yellow	Blinks four times	Warming up
	Green	Blinks slowly	GNSS enabled
	Green	Periodically blinks twice	Vision Systems enabled
	Yellow	Blinks slowly	NO GNSS or Vision Systems
Warning States			
	Yellow	Blinks quickly	Remote controller signal lost
	Red	Blinks slowly	Low battery
	Red	Blinks quickly	Critically low battery
 —	Red	Solid	Critical error
	Alternating red and yellow	Blinks quickly	Compass calibration required

After the motor starts, the front LEDs blink red and green alternately and the aircraft status indicators blink green. The green lights indicate the aircraft is a UAV and the red lights indicate the heading and position of the aircraft.



-  • To obtain better footage, the front LEDs turn off automatically when shooting if the front LEDs are set to auto in DJI Fly. Lighting requirements vary depending on region. Observe local laws and regulations.

Return to Home

Return to Home (RTH) returns the aircraft to the last recorded Home Point when the positioning system is functioning normally. There are three types of RTH: Smart RTH, Low Battery RTH, and Failsafe RTH. The aircraft automatically flies back to the Home Point and lands when Smart RTH is initiated, the aircraft enters Low Battery RTH, or the video link signal is lost during flight.

	GNSS	Description
Home Point	 10	The default Home Point is the first location where the aircraft received a strong to moderately strong GNSS signal where the icon is white. The Home Point can be updated before takeoff as long as the aircraft receives a strong to moderately strong GNSS. If the GNSS signal is weak then the Home Point cannot be updated.

Smart RTH

If the GNSS signal is sufficient, Smart RTH can be used to bring the aircraft back to the Home Point. Smart RTH is initiated either by tapping  in DJI Fly or by pressing and holding the RTH button on the remote controller until it beeps. Exit Smart RTH by tapping  in DJI Fly or by pressing the RTH button on the remote controller.

Advanced RTH

Advanced RTH is enabled if the lighting is sufficient and the environment is suitable for vision systems when Smart RTH triggered. The aircraft will automatically plan the best RTH path, which will be displayed in DJI Fly and will adjust according to the environment.

RTH Settings

RTH settings are available for Advanced RTH. Go the camera view in DJI Fly, tap System, Safety, and then RTH.

1. Optimal: Regardless of the RTH Altitude settings, the aircraft automatically plans the optimal RTH path and adjusts the altitude according to environmental factors such as obstacles and transmission signals. The optimal RTH path means the aircraft will travel the shortest distance possible reducing the amount of battery power used and increasing flight time.
2. Preset: When the aircraft is further than 50 m from the home point when RTH begins, the aircraft will plan the RTH path, fly to an open area while avoiding obstacles, ascend to the RTH Altitude, and return to home using the best path. When the aircraft is a distance of 5 to 50 m from the home point when RTH begins, the aircraft will not ascend to the RTH Altitude and instead return to home using the best path at the current altitude. When the aircraft is near the home point, the aircraft will descend while flying forward if the current altitude is higher than the RTH Altitude.

Advanced RTH Procedure

1. The Home Point is recorded.
2. Advanced RTH is triggered.
3. The aircraft brakes and hover in place.
 - a. The aircraft lands immediately if it is less than 5 m from the Home Point when RTH begins.
 - b. If the aircraft is farther than 5 m from the home point when RTH begins, the aircraft will plan the best path according to the RTH settings and fly to the home point while avoiding obstacles and GEO zones. The aircraft front will always point in the same direction as the flight direction.

- The aircraft will fly automatically according to the RTH settings, environment, and the transmission signal during RTH.
- The aircraft lands and the motors stop after reaching the Home Point.

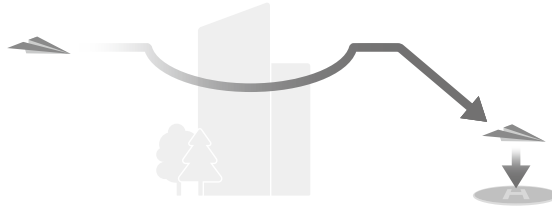

Straight Line RTH

The aircraft will enter Straight Line RTH when the lighting is not sufficient and the environment is not suitable for the Advanced RTH.

Straight Line RTH Procedure:

- The Home Point is recorded.
- Straight Line RTH is triggered.
- The aircraft brakes and hover in place.
 - If the aircraft is farther than 50 m from the Home Point when RTH begins, the aircraft adjusts its orientation and ascends to the preset RTH altitude and flies to the Home Point. If the current altitude is higher than the RTH altitude, the aircraft flies to the Home Point at the current altitude.
 - If the aircraft is at a distance of 5 to 50 m from the Home Point when RTH begins, the aircraft adjusts its orientation and flies to the Home Point at the current altitude. If the current altitude is lower than 2 m when RTH begins, the aircraft will ascend to 2 m and files to the Home Point.
 - The aircraft lands immediately if it is less than 5 m from the Home Point when RTH begins.
- The aircraft lands and the motors stop after reaching the Home Point.



- During Advanced RTH, the aircraft will adjust the flight speed automatically to environmental factors such as wind speed and obstacles.
 - The aircraft cannot avoid small or fine objects such as tree branches or power lines. Fly the aircraft to an open area before using Smart RTH.
 - Set Advanced RTH as Preset if there are power lines or towers that the aircraft cannot avoid on the RTH path and make sure the RTH Altitude is set higher than all obstacles.
 - The aircraft will brake and return to home according to the latest settings if the RTH settings are changed during RTH.
 - If the max altitude is set below the current altitude during RTH, the aircraft will descend to the max altitude and return to home.
 - The RTH Altitude cannot be changed during RTH.
 - If there is a large difference in the current altitude and the RTH altitude, the amount of battery power used cannot be calculated accurately due to wind speeds at different altitudes. Pay extra attention to the battery power and warning prompts in DJI Fly.
 - Advanced RTH will not be available if the lighting condition and environment were not suitable for vision systems during takeoff or RTH.
-



- During Advanced RTH, the aircraft will enter Straight Line RTH if the lighting condition and environment was not suitable for vision systems and the aircraft cannot avoid obstacles. An appropriate RTH altitude must be set before entering RTH.
 - When the remote controller signal is normal during Advanced RTH, the pitch stick can be used to control the flight speed but the orientation and altitude cannot be controlled and the aircraft cannot be flown left or right. Acceleration uses more power. The aircraft cannot avoid obstacles if the flight speed exceeds the effective sensing speed. The aircraft will brake and hover in place and exit from RTH if the pitch stick is pulled all the way down. The aircraft can be controlled after the pitch stick is released.
 - When ascending in Straight Line RTH, the aircraft will stop ascending and exit from RTH if the throttle stick is pulled all the way down. The aircraft can be controlled after the throttle stick is released. When flying forward in Straight Line RTH, the aircraft will brake and hover in place and exit from RTH if the pitch stick is pulled all the way down. The aircraft can be controlled after the pitch stick is released.
 - If the aircraft reaches the max altitude while it is ascending during RTH, the aircraft stops and returns to the Home Point at the current altitude.
 - The aircraft will hover in place if it reaches the max altitude while it is ascending after detecting obstacles in front.
 - During Straight Line RTH, the speed and altitude of the aircraft can be controlled using the remote controller if the remote controller signal is normal. The orientation of the aircraft and the direction of flight, however, cannot be controlled. The aircraft cannot avoid obstacles if the pitch stick is used to accelerate and the flight speed exceeds the effective sensing speed.
-

Low Battery RTH

Low Battery RTH is triggered when the Intelligent Flight Battery is depleted to the point that the safe return of the aircraft may be affected. Return home or land the aircraft immediately when prompted.

In order to avoid unnecessary danger due to insufficient power, the aircraft automatically calculates if the battery power is sufficient to return to the Home Point according to the current position, environment, and flight speed. A warning prompt will appear in DJI Fly when the battery level is low and the aircraft can only support Low Battery RTH.

The user can cancel RTH by pressing the RTH button on the remote controller. If RTH is cancelled following a low battery level warning, the Intelligent Flight Battery may not have enough power for the aircraft to land safely, which may lead to the aircraft crashing or being lost.

The aircraft will land automatically if the current battery level can only support the aircraft long enough to descend from its current altitude. Auto landing cannot be canceled but the remote controller can be used to alter the direction and the speed of descent of the aircraft during landing. The throttle stick can be used to increase the ascent speed by 1 m/s if there is sufficient power. The throttle stick cannot be used to increase the ascent speed and the aircraft will land if there is no power left.

During auto landing, find an appropriate place to land the aircraft as soon as possible. The aircraft will fall if there is no power remaining.

Failsafe RTH

If the Home Point was successfully recorded and the compass is functioning normally, Failsafe RTH automatically activates after the remote controller signal is lost for more than six seconds. Note that the action the aircraft performs when the remote controller is lost must be set to Return to Home in DJI Fly.

When the lighting is sufficient and the vision systems are working normally, DJI Fly will display the RTH path that was generated by the aircraft before the remote controller signal was lost and return to home using Advanced RTH according to the RTH settings. The aircraft will remain in RTH even if the remote

controller signal is restored.

When the lighting is not sufficient and the vision systems are not available, the aircraft will enter Original Route RTH.

Original Route RTH Procedure:

1. The aircraft brakes and hover in place.
2. a. If the aircraft is farther than 50 m from the Home Point, the aircraft adjust its orientation and flies backwards for 50 m on its original flight route before entering Straight Line RTH.
b. If the aircraft is farther than 5 m but less than 50 m from the Home Point, it enters Straight Line RTH.
c. The aircraft lands immediately if it is less than 5 m from the Home Point when RTH begins.
3. The aircraft lands and the motors stop after reaching the Home Point.

The aircraft will enter or remain in Straight Line RTH even if the remote controller signal is restored during Original Route RTH.



- If the RTH is triggered through DJI Fly and the aircraft is farther than 5 m from the Home Point, a prompt will appear in the app to select a landing option.
 - The aircraft may not be able to return to the Home Point normally if the GNSS signal is weak or unavailable. The aircraft may enter ATTI mode if the GNSS signal becomes weak or unavailable after entering Failsafe RTH. The aircraft will hover in place for a while before landing.
 - It is important to set a suitable RTH altitude before each flight. Launch DJI Fly and set the RTH altitude. The default RTH altitude is 100 m.
 - The aircraft cannot avoid obstacles during Failsafe RTH if the vision systems are unavailable.
 - GEO zones may affect the RTH. Avoid flying near GEO zones.
 - The aircraft may not be able to return to a Home Point when the wind speed is too high. Fly with caution.
 - Be aware of small or fine objects (such as tree branches or power lines) or transparent objects (such as water or glass) during RTH. Exit RTH and control the aircraft manually in an emergency.
 - RTH may not be available in some environments even if the vision systems are working. The aircraft will exit RTH in such cases.
-

Landing Protection

Landing Protection will activate during Smart RTH. When aircraft begins landing, Landing Protection is enabled.

1. During Landing Protection, the aircraft will automatically detect and carefully land on suitable ground.
2. If the ground is determined unsuitable for landing, the aircraft will hover and wait for pilot confirmation.
3. If Landing Protection is not operational, DJI Fly will display a landing prompt when the aircraft descends below 0.5 m. Pull down on the throttle stick or use the auto landing slider to land.

Precision Landing

The aircraft automatically scans and attempts to match the terrain features below during RTH. The aircraft will land when the current terrain matches the Home Point. A prompt will appear in DJI Fly if the terrain match fails.



- Landing Protection is activated during Precision Landing.
 - The Precision Landing performance is subject to the following conditions:
 - a. The Home Point must be recorded upon takeoff and must not be changed during flight. Otherwise, the aircraft will have no record of the Home Point terrain features.
 - b. During takeoff, the aircraft must ascend at least 7 m before flying horizontally.
 - c. The Home Point terrain features must remain largely unchanged.
 - d. The terrain features of the Home Point must be sufficiently distinctive. Terrain such as snow-covered areas are not suitable.
 - e. The lighting conditions must not be too light or too dark.
 - The following actions are available during Precision Landing:
 - a. Press the throttle stick down to accelerate landing.
 - b. Move the control sticks in any direction apart from the throttle direction to stop Precision Landing. The aircraft will descend vertically after the control sticks are released.
-

Vision Systems and Infrared Sensing System

DJI Mavic 3 is equipped with both an Infrared Sensing System and Forward, Backward, Lateral, Upward, and Downward Vision Systems.

The Upward and Downward Vision Systems consist of two cameras each, and the Forward, Backward, and Lateral Vision Systems consist of four cameras in total.

The Infrared Sensing System consists of two 3D infrared modules. The Downward Vision System and Infrared Sensing System helps the aircraft maintain its current position, hover in place more precisely, and to fly indoors or in other environments where GNSS is unavailable.

In addition, the Auxiliary Bottom Light located on the underside of the aircraft improves visibility for the Downward Vision System in weak light conditions.

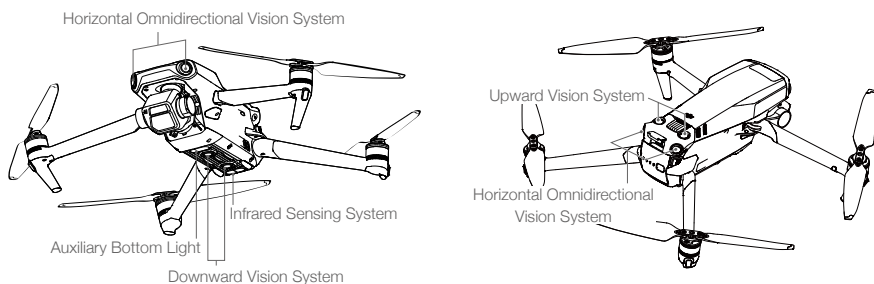

Detection Range

Forward Vision System

Precision Measurement Range: 0.5-20 m; FOV: 90° (horizontal), 103° (vertical)

Backward Vision System

Precision Measurement Range: 0.5-16 m; FOV: 90° (horizontal), 103° (vertical)

Lateral Vision System

Precision Measurement Range: 0.5-25 m; FOV: 90° (horizontal), 85° (vertical)

Upward Vision System

Precision Measurement Range: 0.2-10 m; FOV: 100° (front and back), 90° (left and right)

Downward Vision System

Precision Measurement Range: 0.3-18 m; FOV: 130° (front and back), 160° (left and right). The Downward Vision System works best when the aircraft is at an altitude of 0.5 to 30 m.

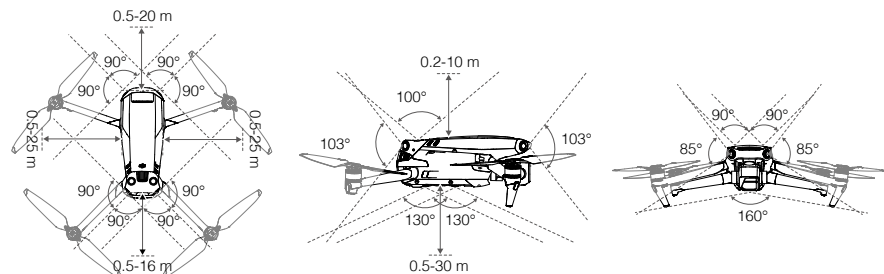

Using the Vision Systems

When GNSS is unavailable, the Downward Vision System is enabled if the surface has a clear texture and sufficient light.

The Forward, Backward, Lateral, and Upward Vision Systems will activate automatically when the aircraft is powered on if the aircraft is in Normal or Cine mode and Obstacle Avoidance is set to Bypass or Brake in DJI Fly. The aircraft can actively brake when detecting obstacles when using the Forward, Backward, Lateral, and Upward Vision Systems. The Forward, Backward, Lateral, and Upward Vision Systems work best with adequate lighting and clearly marked or textured obstacles. Due to inertia, users must make sure to brake the aircraft within a reasonable distance.



- Vision Systems have limited ability to sense and avoid obstacles, and the performance may be affected by the surrounding environment. Make sure to maintain visual line of sight with the aircraft and pay attention to prompts in DJI Fly.
 - The Downward Vision Systems work best when the aircraft is at an altitude from 0.5 to 30 m if there is no GNSS available. Extra caution is required if the altitude of the aircraft is above 30 m as the Vision Systems may be affected.
 - The Auxiliary Bottom Light can be set in DJI Fly. If set to Auto, it is automatically enabled when the environment light is too weak. Note that the Vision System cameras performance may be affected when the Auxiliary Bottom Light is enabled. Fly with caution if the GNSS signal is weak.
 - The Vision Systems may not function properly when the aircraft is flying near water or snow-covered areas. Therefore, the aircraft may not be able to actively avoid the water below when landing. Make sure to maintain visual line of sight with the aircraft and pay attention to prompts in DJI Fly.
 - The Vision Systems cannot work properly over surfaces that do not have clear pattern variations. The Vision Systems cannot work properly in any of the following situations. Operate the aircraft cautiously.
 - a. Flying near monochrome surfaces (e.g., pure black, pure white, pure green).
 - b. Flying near highly reflective surfaces.
 - c. Flying near water or transparent surfaces.
 - d. Flying near moving surfaces or objects.
 - e. Flying in an area where the lighting changes frequently or drastically.
 - f. Flying near extremely dark (< 10 lux) or bright (> 40,000 lux) surfaces.
 - g. Flying near surfaces that strongly reflect or absorb infrared waves (e.g., mirrors).
 - h. Flying near surfaces without clear patterns or texture.
 - i. Flying near surfaces with repeating identical patterns or textures (e.g., tiles with the same design).
 - j. Flying near obstacles with small surface areas (e.g., tree branches).
 - Keep the sensors clean at all times. DO NOT tamper with the sensors. DO NOT use the aircraft in dusty or humid environments.
 - Vision System cameras may need to be calibrated after being stored for an extended period. A prompt will appear in DJI Fly and calibration will be performed automatically.
 - DO NOT fly when it is raining, foggy, or if there is no clear sight.
 - Check the following before each takeoff:
 - a. Make sure there are no stickers or any other obstructions over the Infrared Sensing and Vision Systems.
 - b. If there is any dirt, dust, or water on the Infrared Sensing and Vision Systems, clean it with a soft cloth. Do not use any cleanser that contains alcohol.
 - c. Contact DJI Support if there is any damage to the glass of the Infrared Sensing and Vision Systems.
 - DO NOT obstruct the Infrared Sensing System.
-

Intelligent Flight Mode

FocusTrack

FocusTrack includes Spotlight 2.0, Point of Interest 3.0, and ActiveTrack 5.0.

Spotlight 2.0

Control the aircraft manually while the camera remains locked on the subject. The mode supports both stationary and moving subjects such as vehicles, boats, and people. Move the roll stick to circle the subject, move the pitch stick to alter the distance from the subject, move the throttle stick to change the altitude, and move the pan stick to adjust the frame.

In Spotlight mode, the aircraft will hover in place when there is an obstacle detected when the vision systems are working normally, no matter the behavior is set to Bypass or Brake in DJI Fly. Note that the vision systems are disabled in Sport mode.

Point of Interest 3.0 (POI 3.0)

The aircraft tracks the subject in a circle based on the radius and flight speed that is set. The mode supports both static and moving subjects such as vehicles, boats, and people. The max flight speed is 15 m/s and the flight speed may be adjusted dynamically according the actual radius. Move the roll stick to change the speed, the pitch stick to alter the distance from the subject, the throttle stick to change the altitude, and the pan stick to adjust the frame.

The aircraft will bypass obstacles in this mode regardless of the settings in DJI Fly when the vision systems are working normally.

ActiveTrack 5.0

ActiveTrack 5.0 is divided into Trace and Parallel, which support tracking both stationary and moving subjects such as vehicles, boats, and people. In Sport, Normal, and Cine mode, the maximum flight speed is 12 m/s when flying forward and backward and 15 m/s when flying left and right. Move the roll stick to circle the subject, the pitch stick to alter the distance from the subject, the throttle stick to change the altitude, and the pan stick to adjust the frame.

The aircraft will bypass obstacles in ActiveTrack 5.0 regardless of the settings in DJI Fly.

Trace: The aircraft tracks the subject at a constant distance and altitude with a constant angle with the direction of the subject. The aircraft can track subjects in eight directions including front, back, left, right, forward diagonal left, front diagonal right, backward diagonal left, and backward diagonal right. The direction is set to back by default and this setting is only available when the subject is moving in a stable direction. The direction of tracking can be adjusted during tracking.

Parallel: The aircraft tracks the subject at a constant angle and distance from the side.

In ActiveTrack, the aircraft maintains a distance of 4-20 m when tracking people with an altitude of 2-20 m (the optimal distance is 5-10 m and altitude is 2-10 m), and a distance of 6-100 m when tracking vehicles or boats with an altitude of 6-100 m (the optimal distance is 20-50 m and altitude is 10-50 m). The aircraft will fly to the supported distance and altitude range if the distance and altitude is out of range when ActiveTrack begins. Fly the aircraft at the optimal distance and altitude for the best performance.

Using FocusTrack

1. Take off.

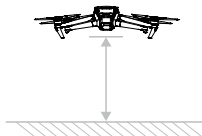

2. Drag a box around the subject in the camera view or enable Subject Scanning under Control settings in DJI Fly Control and tap the recognized subject to enable FocusTrack. The default mode is Spotlight. Tap the icon to switch between Spotlight, ActiveTrack, and POI. FocusTrack supports 2x zoom. The zoom ratio will be limited if it is too large to recognize a subject. Tap GO to start FocusTrack.

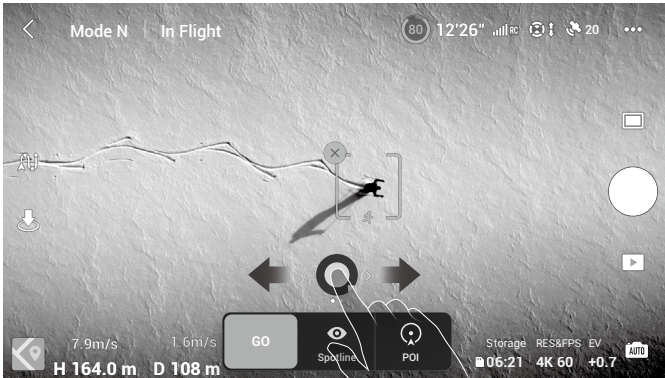

3. In Trace of ActiveTrack, the tracking direction can be changed using the direction wheel. The direction wheel will be minimized if there is no operation for an extended period or any other area of the screen is tapped. Trace or Parallel can be selected once the direction wheel is minimized. The tracking will be reset to back once Trace is selected again.

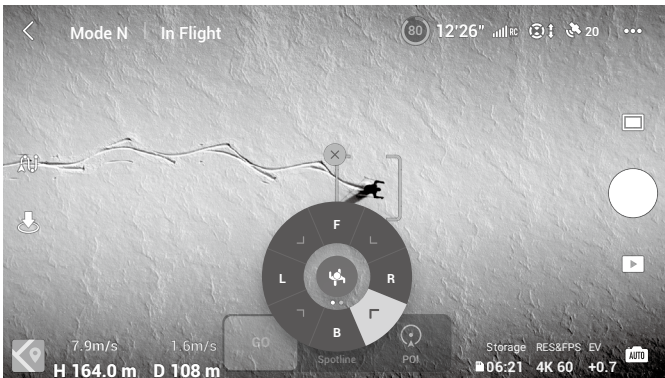

4. Tap the shutter/record button to take photos or start recording. View the footage in Playback.

Exiting FocusTrack

Tap Stop in DJI Fly or press the Flight Pause button once on the remote controller to exit FocusTrack.

- ⚠ • DO NOT use FocusTrack in areas with people and animals running or vehicles moving.
- DO NOT use FocusTrack in areas with small or fine objects (e.g., tree branches or power lines), or transparent objects (e.g., water or glass).
- Operate the aircraft manually. Press the Flight Pause button or tap stop in DJI Fly in an emergency.



- Be extra vigilant when using FocusTrack in any of the following situations:
 - a. The tracked subject is not moving on a level plane.
 - b. The tracked subject changes shape drastically while moving.
 - c. The tracked subject is out of sight for an extended period.
 - d. The tracked subject is moving on a snowy surface.
 - e. The tracked subject has a similar color or pattern to its surrounding environment.
 - f. The lighting is extremely low (<300 lux) or high (>10,000 lux).
- Make sure to follow local privacy laws and regulations when using FocusTrack.
- It is recommended to only track vehicles, boats, and people (but not children). Fly with caution when tracking other subjects.
- In supported moving subjects, vehicles refer to cars and small to medium-sized yachts.
- Do not track a remote control model car or boat.
- The tracking subject may inadvertently swap to another subject if they pass nearby to each other.
- FocusTrack is disabled in Explore mode, when using a ND filter, or when recording in 5.1K and above or 120fps and above, and Apple ProRes 422 HQ/422/422LT.
- ActiveTrack is unavailable when the lighting is insufficient and the vision systems are unavailable. POI for static subjects and Spotlight can still be used, but obstacle sensing is not available.
- FocusTrack is unavailable when the aircraft is on the ground.
- FocusTrack may not function properly when the aircraft is flying near flight limits or in a GEO zone.

MasterShots

MasterShots keeps the subject in the center of the frame while executing different maneuvers in sequence to generate a short cinematic video.

Using MasterShots

1. Take off and hover at least 2 m above the ground.

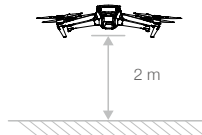

2. In DJI Fly, tap the shooting mode icon to select MasterShots and follow the prompts. Make sure that you understand how to use the shooting mode and that there are no obstacles in the surrounding area.
3. Select your target subject in the camera view by tapping the circle on the subject or dragging a box around the subject. Tap **Start** to begin recording. The aircraft flies back to its original position once shooting is finished.



4. Tap  to access the video.

Exiting MasterShots

Press the Flight Pause button once or tap  in DJI Fly to exit MasterShots. The aircraft will hover in place.

-  Use MasterShots at locations that are clear of buildings and other obstacles. Make sure that there are no humans, animals, or other obstacles on the flight path. When the lighting is sufficient and the environment is suitable for vision systems, the aircraft will brake and hover in place if there is an obstacle detected.
- Pay attention to objects around the aircraft and use the remote controller to avoid collisions with the aircraft.
- DO NOT use MasterShots in any of the following situations:
 - When the subject is blocked for an extended period or outside the line of sight.
 - When the subject is similar in color or pattern with the surroundings.
 - When the subject is in the air.
 - When the subject moves fast.
 - The lighting is extremely low (<300 lux) or high (>10,000 lux).
- DO NOT use MasterShots in places that are close to buildings or where the GNSS signal is weak. Otherwise, the flight path will be unstable.
- Make sure to follow local privacy laws and regulations when using MasterShots.

Hyperlapse

Hyperlapse shooting modes include Free, Circle, Course Lock, and Waypoint.



Free

The aircraft automatically takes photos and generates a timelapse video. Free mode can be used while the aircraft is on the ground. After takeoff, control the movement and gimbal angle of the aircraft using the remote controller. Follow the steps below to use Free:

- Set the interval time, video duration, and max speed. The screen displays the number of photos that will be taken and how long the shooting time will be.
- Tap the shutter/record button to begin.

Cruise Control: Set the function of the Customizable button (C1 or C2 button for DJI RC Pro and Fn button for DJI RC-N1 remote controller) to Cruise Control and press the Customizable button and control stick at the same time to enter Cruise Control. The aircraft will continue to fly at the same speed.

Circle

The aircraft automatically takes photos while flying around the selected subject to generate a timelapse video. Follow the steps below to use Circle:

1. Set the interval time, video duration, and max speed. Circle can be selected to travel in either a clockwise or counter-clockwise direction. The screen displays the number of photos that will be taken and how long the shooting time will be.
2. Select a subject on the screen. Use the pan stick and gimbal dial to adjust the frame.
3. Tap the shutter/record button to begin.

Course Lock

Course Lock can be used in two ways. In the first way, the orientation of the aircraft is fixed, but a subject cannot be selected. In the second way, the orientation of the aircraft is fixed and the aircraft flies around a selected object. Follow the steps below to use Course Lock:

1. Set the interval time, video duration, and max speed. The screen displays the number of photos that will be taken and how long the shooting time will be.
2. Set a flight direction.
3. If applicable, select a subject. Use the gimbal dial and pan stick to adjust the frame.
4. Tap the shutter/record button to begin.

Waypoints

The aircraft automatically takes photos on a flight path of two to five waypoints and generates a timelapse video. The aircraft can fly in order from waypoint 1 to 5 or 5 to 1. Follow the steps below to use Waypoints.

1. Set the desired waypoints.
2. Set the interval time, video duration, and max speed. The screen displays the number of photos that will be taken and how long the shooting time will be.
3. Tap the shutter button to begin.







The aircraft will generate a timelapse video automatically, which is viewable in playback. Users can select Output Quality and Photo Type in System Settings-Camera page in DJI Fly. Mavic 3 supports the fast compositing function of Hyperlapse. Select "Preview" in the output quality. Mavic 3 will not perform stabilization and brightness smoothing but will only synthesize the effect preview film, which can save the compositing time. Users can synthesize the original film into a high-quality film later.



- For optimal performance, it is recommended to use Hyperlapse at an altitude higher than 50 m and to set a difference of at least two seconds between the interval time and shutter.
 - It is recommended to select a static subject (e.g., high-rise buildings, mountainous terrain) at a safe distance from the aircraft (farther than 15 m). Do not select a subject that is too near the aircraft.
 - When the lighting is sufficient and the environment is suitable for vision systems, the aircraft brakes and hovers in place if an obstacle is detected during Hyperlapse. If the lighting becomes insufficient or the environment is not suitable for vision systems during Hyperlapse, the aircraft will continue to shoot without obstacle avoidance. Fly with caution.
 - The aircraft only generates a video if it has taken at least 25 photos, which is the amount required to generate a one second video. The video is generated when a user command is received from the remote controller or if the mode is exited unexpectedly such as when Low Battery RTH is triggered.
-

QuickShots

QuickShots shooting modes include Dronie, Rocket, Circle, Helix, Boomerang, and Asteroid. Mavic 3 records according to the selected shooting mode and automatically generates a short video. The video can be viewed, edited, or shared to social media from playback.

-  **Dronie:** The aircraft flies backward and ascends, with the camera locked on the subject.
-  **Rocket:** The aircraft ascends with the camera pointing downward.
-  **Circle:** The aircraft circles around the subject.
-  **Helix:** The aircraft ascends and spirals around the subject.
-  **Boomerang:** The aircraft flies around the subject in an oval path, ascending as it flies away from its starting point and descending as it flies back. The starting point of the aircraft forms one end of the long axis of the oval while the other end of the long axis is at the opposite side of the subject from the starting point. Make sure there is sufficient space when using Boomerang. Allow a radius of at least 30 m around the aircraft and allow at least 10 m above the aircraft.
-  **Asteroid:** The aircraft flies backward and upward, takes several photos, and then flies back to the starting point. The video generated starts with a panorama of the highest position and then shows the descent. Make sure there is sufficient space when using Asteroid. Allow at least 40 m behind and 50 m above the aircraft.

Using QuickShots

1. Take off and hover at least 2 m above the ground.

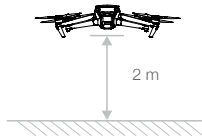

2. In DJI Fly, tap the shooting mode icon to select QuickShots and follow the prompts. Make sure that you understand how to use the shooting mode and that there are no obstacles in the surrounding area.
3. Select your target subject in the camera view by tapping the circle on the subject or dragging a box around the subject. Choose a shooting mode and tap Start to begin recording.



4. Tap  to access the video.

Exiting QuickShots

Press the Flight Pause button once or tap  in DJI Fly to exit QuickShots. The aircraft will hover in place.



- Use QuickShots at locations that are clear of buildings and other obstacles. Make sure that there are no humans, animals, or other obstacles on the flight path. The aircraft will brake and hover in place if there is an obstacle detected.
- Pay attention to objects around the aircraft and use the remote controller to avoid collisions with the aircraft.
- DO NOT use QuickShots in any of the following situations:
 - a. When the subject is blocked for an extended period or outside the line of sight.
 - b. When the subject is more than 50 m away from the aircraft.
 - c. When the subject is similar in color or pattern with the surroundings.
 - d. When the subject is in the air.
 - e. When the subject moves fast.
 - f. The lighting is extremely low (<300 lux) or high (>10,000 lux).
- DO NOT use QuickShots in places that are close to buildings or where the GNSS signal is weak. Otherwise, the flight path will be unstable.
- Make sure to follow local privacy laws and regulations when using QuickShots.

Waypoint Flight

Waypoint Flight enables the aircraft to capture images during a flight according to the waypoint flight route generated by the preset waypoints. Points of Interest (POI) can be linked to the waypoints. The heading will point toward the POI during flight. A waypoint flight route can be saved and repeated.

Using Waypoint Flight

1. Enable Waypoint Flight

Tap the Waypoint Flight icon on the left of the camera view in DJI Fly to enable Waypoint Flight.



2. Waypoint Settings

Pin Waypoint

Waypoints can be pinned via the map before take off.

Waypoints can be pinned via the remote controller, operation panel, and map after aircraft take off, GNSS is required.

- a. Using the Remote Controller: Press once on the Fn button (RC-N1) or C1 button (DJI RC/DJI RC Pro) to pin a waypoint.
- b. Using the Operation Panel: Tap + on the operation panel to pin a waypoint.
- c. Using the Map: Enter and tap on the map to pin a waypoint. The default altitude of a waypoint via the map is set to 50 m.

Press and hold on a waypoint to move its position on the map.

- 💡 • When setting a waypoint, it is recommended to fly to the location for a more accurate and smoother imaging result during the Waypoint Flight.
- The aircraft horizontal GNSS, altitude from the take-off point, heading, focal length, and gimbal tilt will be recorded if the waypoint is pinned via the remote controller and operation panel.
- Connect the remote controller to the internet and download the map before using the map to pin a waypoint. When the waypoint is pinned via the map, only the aircraft horizontal GNSS can be recorded.

- ⚠️ • The flight route will curve between waypoints, and the aircraft altitude may decrease during the flight route. Make sure to avoid any obstacles below when setting a waypoint.

Settings

Tap the waypoint number for settings such as camera action, altitude, speed, heading, gimbal tilt, zoom, and hovering time.

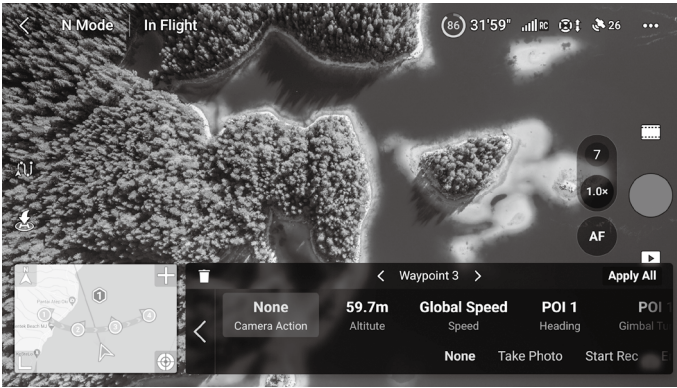

Camera Action Choose between Non, Take Photo, Start or Stop Recording.

Altitude Set the altitude from the take-off point. Ensure to take off at the same altitude to obtain better performance when a Waypoint Flight is repeated.

Speed The flight speed can be set to Global Speed or Custom.
 When Global Speed is selected, the aircraft will fly at the same speed during the waypoint flight route. When Custom is selected, the aircraft will accelerate or decelerate at a steady speed when flying between waypoints. The preset speed will be reached when the aircraft is at the waypoint.

Heading Choose between Follow Course, POI, Custom, and Manual.
 Custom: Drag the bar to adjust the heading. The heading can be previewed in the map view.
 Manual: The heading can be adjusted by the user during a Waypoint Flight.

Gimbal Tilt Choose between POI, Custom, and Manual.
 POI: Tap the number of the POI to point the camera toward the POI.
 Custom: Drag the bar to adjust the tilt of the gimbal.
 Manual: Gimbal tilt can be adjusted by the user during a Waypoint Flight.

Zoom Choose between Auto, Digital Zoom, and Manual.
 Auto: The zoom ratio will be adjusted by the aircraft when flying between two waypoints.
 Digital: Drag the bar to adjust the zoom ratio.
 Manual: The zoom ratio can be adjusted by the user during the waypoint flight route.

Hovering Time Set the duration of the aircraft hovering time of the current waypoints.

All the settings except camera action can be applied to all waypoints after selecting Apply to All. Tap the delete icon to delete a waypoint.

3. POI Settings

Tap POI on the operation panel to switch to POI settings. Use the same method to pin a POI as used with a waypoint.

Tap the number of the POI to set the altitude of the POI. The POI can be linked to a waypoint. Multiple waypoints can be linked to the same POI, the camera will point toward the POI during the Waypoint Flight.

4. Plan a Waypoint Flight

Tap ●●● to plan a Waypoint Flight. Tap Next to adjust the Global Speed, the behavior of End of Flight, On Signal Lost, and Start Point. The settings apply to all waypoints.

5. Perform a Waypoint Flight

-
- ⚠ • Check the Obstacle Avoidance settings in the Safety section of DJI Fly before performing the Waypoint Flight. When set to Bypass or Brake, the aircraft will brake and hover in place if an obstacle is detected during the Waypoint Flight. The aircraft cannot avoid obstacles if Obstacle Avoidance is disabled. Fly with caution.
 - Observe the environment and ensure there are no obstacles on the route before performing Waypoint Flight.
 - Make sure to maintain visual line of sight (VLOS) with the aircraft. Press the flight pause button in an emergency situation.
-

- Tap GO to upload the waypoint flight task. Tap the [■] button to cancel the uploading process and return to the waypoint flight edit status.
 - The waypoint flight task will be performed after uploading, the flight duration, waypoints, and distance and will be displayed on the camera view. The control stick input will change the flight speed during a Waypoint Flight.
 - Tap [■] to pause the Waypoint Flight after the task begins. Tap [⊗] to stop Waypoint Flight and return to the waypoint flight edit status. Tap [▶] to continue the Waypoint Flight.
-

- ⚠ • When the signal is lost during flight, the aircraft will perform the action set in On Signal Lost.
 - When the Waypoint Flight is finished, the aircraft will perform the action set in End of Flight.
-

6. Library

When planning a Waypoint Flight, the task will be generated automatically and saved every minute. Tap the list icon on the left to enter Library and save the task manually.

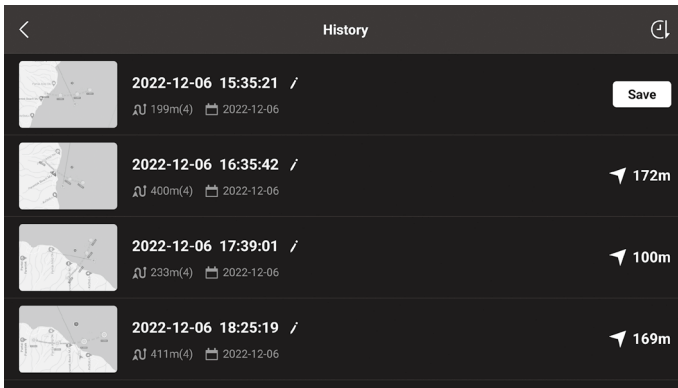

- Tap the list icon to check the saved tasks, and tap to open a task.
- Tap the icon to edit the name of the task.
- Slide left to delete a task.
- Tap the icon on the top right corner to change the order of the tasks.

☰:Tasks will be saved according to the time.

📏:Tasks will be saved according to the distance between the start waypoint and the current position of the aircraft from shortest to farthest.

7. Exit Waypoint Flight

Tap the icon to exit Waypoint Flight. Tap Save and Exit to save the task to Library and exit.

Cruise Control

The Cruise Control function enables the aircraft to lock the current control stick input of the remote control when conditions permit. Fly at the speed corresponding to the current control stick input without continually using control stick movements, and also supports more camera movements such as spiraling up by increasing the control stick input.

Using Cruise Control

1. Set the Cruise Control Button

Go to DJI Fly, select System Settings, Control, and then set the C1 or C2 button of the DJI RC remote controller or the Fn button of the RC-N1 remote controller to Cruise Control.

2. Enter Cruise Control

Push the control stick in any direction and press the Cruise Control button simultaneously. According to the control stick input, the aircraft will fly at the current speed. The control stick can be released and will automatically return to the center. Before the control stick returns to the center, press the Cruise Control button again, and the aircraft will reset the flight speed based on the current control stick input. Push the control stick after it returns to the center, and the aircraft will fly at the increased speed based on the previous speed. In this case, press the Cruise Control button again, and the aircraft will fly at the increased speed.

3. Exit Cruise Control

Press the Cruise Control button without a control stick input, flight pause button of the remote controller, or disable Cruise Control to exit cruise control.



- Cruise Control is available in Normal, Cine, and Sport mode or APAS, Free Hyperlapse, and Spotlight.
 - Cruise Control cannot be started without a control stick input.
 - Cruise Control cannot be started or will exit automatically when near the Max Altitude or Max Distance.
 - Cruise Control cannot be started or will exit automatically when the aircraft disconnects from the remote controller or DJI Fly.
 - Cruise Control cannot be started or will exit automatically after the aircraft senses an obstacle and will hover in place.
 - During RTH or auto landing, the aircraft cannot enter or will automatically exit the Cruise Control.
 - Cruise Control will exit automatically when switching flight modes.
 - The obstacle avoidance in Cruise Control follows the current flight mode. Fly with caution.
-

Advanced Pilot Assistance Systems (APAS 5.0)

The Advanced Pilot Assistance Systems 5.0 (APAS 5.0) feature is available in Normal and Cine mode. When APAS is enabled, the aircraft continues to respond to user commands and plans its path according to control stick inputs and the flight environment. APAS makes it easier to avoid obstacles, obtain smoother footage, and gives a better flying experience.

Keep moving the control sticks in any directions. The aircraft will avoid the obstacles by flying above, below, or to the left or right of the obstacle. The aircraft can also respond to the control stick inputs while avoiding obstacles.

When APAS is enabled, the aircraft can be stopped by pressing the Flight Pause button on the remote controller or tapping the screen in DJI Fly. The aircraft hovers for three seconds and awaits further pilot commands.

To enable APAS, open DJI Fly, enter System Settings, then Safety, and enable APAS by selecting Bypass.

Select Normal or Nifty mode when using Bypass. Nifty mode, the aircraft can fly faster, smoother, and closer to obstacles obtaining better footage while avoiding obstacles. Meanwhile, the risk of crashing with the obstacles increases. Fly with caution.

Nifty cannot work normally in the following situations:

1. When aircraft orientation changes rapidly flying near obstacles when using Bypass.
2. When flying through narrow obstacles such as canopies or bushes at high speed.
3. When flying near obstacles that are too small to detect.
4. When flying with the propeller guard.

Landing Protection

Landing Protection will activate if Obstacle Avoidance is set to Bypass or Brake and the user pulls the throttle stick down to land the aircraft. Landing Protection is enabled once the aircraft begins to land.

1. During Landing Protection, the aircraft will automatically detect and carefully land on suitable ground.
2. If the ground is determined unsuitable for landing, the aircraft will hover when the aircraft descends below 0.8 m. Pull down on the throttle stick for more than five seconds and the aircraft will land without obstacle avoidance.



- Make sure you use APAS when the vision systems are available. Make sure there are no people, animals, objects with small surface areas (such as tree branches), or objects with transparent surfaces (such as glass or water) along the flight path.
 - Make sure you use APAS when the Downward Vision System is available or the GNSS signal is strong. APAS may not function properly when the aircraft is flying near water or snow-covered areas.
 - Be extra cautious when flying in extremely dark (<300 lux) or bright (>10,000 lux) environments.
 - Pay attention to DJI Fly and make sure APAS is working normally.
 - APAS may not function properly when the aircraft is flying near flight limits or in a GEO zone.
-

Flight Recorder

Flight data including flight telemetry, aircraft status information, and other parameters are automatically saved to the internal data recorder of the aircraft. The data can be accessed using DJI Assistant 2 (Consumer Drones Series).

QuickTransfer

Mavic 3 can connect directly to mobile devices via Wi-Fi, enabling users to download photos and videos from the aircraft to the mobile device through DJI Fly without the need of the RC-N1 remote controller. Users can enjoy faster and more convenient downloads with a transmission rate of up to 80 MB/s.

Usage

Method 1: mobile device is not connected to the remote controller

1. Power on the aircraft and wait until the self-diagnostic tests of the aircraft are complete.
2. Make sure Bluetooth and Wi-Fi is enabled on the mobile device. Launch DJI Fly and a prompt will automatically appear to connect to the aircraft.
3. Tap Connect. Once successfully connected, the files on the aircraft can be accessed and downloaded at a high speed.

Method 2: mobile device is connected to the remote controller

1. Make sure that the aircraft is connected to the mobile device via the remote controller and the motors have not started.
2. Enable Bluetooth and Wi-Fi on the mobile device.
3. Launch DJI Fly, enter playback, and tap in the upper right corner to access the files on the aircraft to download at high speed.



- DJI RC Pro cannot support QuickTransfer.
 - The maximum download speed can only be achieved in countries and regions where the 5.8 GHz frequency is permitted by laws and regulations, when using devices that support 5.8 GHz frequency band and Wi-Fi 6 connection, with the footage using the internal storage of aircraft, and in an environment without interference or obstruction. If 5.8 GHz is not allowed by local regulations (such as in Japan), the mobile device of the user will not support the 5.8 GHz frequency band or the environment will have severe interference. Under these circumstances, QuickTransfer will use the 2.4 GHz frequency band and its maximum download rate will reduce to 10 MB/s.
 - Make sure that Bluetooth, Wi-Fi, and location services are enabled on the mobile device before using QuickTransfer.
 - When using QuickTransfer, it is not necessary to enter the Wi-Fi password on the settings page of the mobile device in order to connect. Launch DJI Fly and a prompt will appear to connect the aircraft.
 - Use QuickTransfer in an unobstructed environment with no interference and stay away from sources of interference such as wireless routers, Bluetooth speakers, or headphones.
-

Propellers

There are two types of DJI Mavic 3 Low-Noise Quick Release Propellers, which are designed to spin in different directions. Marks are used to indicate which propellers should be attached to which motors. Make sure to match the propeller and motor following the instructions.

Attaching the Propellers

Attach the propellers with marks to the motors with marks and the unmarked propellers to the motors without marks. Press each propeller down onto the motor and turn until it is secure.

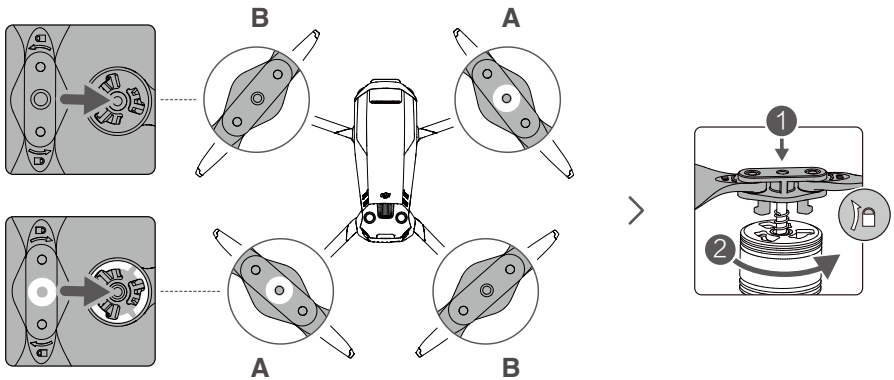

Detaching the Propellers

Press the propellers down onto the motors and rotate them in the unlock direction.



- Propeller blades are sharp. Handle with care.
- Only use official DJI propellers. DO NOT mix propeller types.
- Purchase the propellers separately if necessary.
- Make sure that the propellers are installed securely before each flight.
- Make sure all propellers are in good condition before each flight. DO NOT use aged, chipped, or broken propellers.
- Stay away from the rotating propellers and motors to avoid injuries.
- Do not squeeze or bend the propellers during transportation or storage.
- Make sure the motors are mounted securely and rotating smoothly. Land the aircraft immediately if a motor is stuck and unable to rotate freely.
- DO NOT attempt to modify the structure of the motors.
- DO NOT touch or let your hands or body come in contact with the motors after flight as they may be hot.
- DO NOT block any of the ventilation holes on the motors or the body of the aircraft.
- Make sure the ESCs sound normal when powered on.

Intelligent Flight Battery

The DJI Mavic 3 Intelligent Flight Battery is a 15.4 V, 5000 mAh battery with smart charging and discharging functionality.

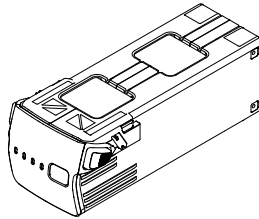

Battery Features

1. **Battery Level Display:** The LED indicators display the current battery level.
2. **Auto-Discharging Function:** To prevent swelling, the battery automatically discharges to 96% of the battery level when it is idle for three days, and automatically discharges to 60% of the battery level when it is idle for nine days. It is normal to feel moderate heat being emitted from the battery during the discharging process.
3. **Balanced Charging:** During charging, the voltages of the battery cells are automatically balanced.
4. **Overcharge Protection:** The battery stops charging automatically once fully charged.
5. **Temperature Detection:** In order to protect itself, the battery only charges when the temperature is between 5° and 40° C (41° and 104° F).
6. **Overcurrent Protection:** The battery stops charging if an excess current is detected.
7. **Over-Discharge Protection:** Discharging stops automatically to prevent excess discharge when the battery is not in use. Over-discharge protection is not enabled when the battery is in use.
8. **Short Circuit Protection:** The power supply is automatically cut if a short circuit is detected.
9. **Battery Cell Damage Protection:** DJI Fly displays a warning prompt when a damaged battery cell is detected.
10. **Hibernation Mode:** The battery switches off after 20 minutes of inactivity to save power. If the battery level is less than 5%, the battery enters Hibernation mode to prevent over-discharge after being idle for six hours. In Hibernation mode, the battery level indicators do not illuminate. Charge the battery to wake it from hibernation.
11. **Communication:** Information about the voltage, capacity, and current of the battery is transmitted to the aircraft.



- Refer to the Safety Guidelines and the battery sticker before use. Users take full responsibility for all operations and usage.
-

Using the Battery

Checking Battery Level

Press the power button once to check the battery level.

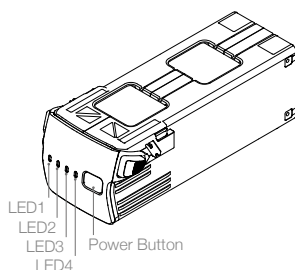

Battery Level LEDs

○ : LED is on ◉ : LED is flashing ○ : LED is off

LED1	LED2	LED3	LED4	Battery Level
○	○	○	○	Battery Level \geq 88%
○	○	○	◉	75% \leq Battery Level < 88%
○	○	○	○	63% \leq Battery Level < 75%
○	○	◉	○	50% \leq Battery Level < 63%
○	○	○	○	38% \leq Battery Level < 50%
○	◉	○	○	25% \leq Battery Level < 38%
○	○	○	○	13% \leq Battery Level < 25%
◉	○	○	○	0% \leq Battery Level < 13%

Powering On/Off

Press the power button once, then press again, and hold for two seconds to power the battery on or off. The battery level LEDs display the battery level when the aircraft is powered on.

Low Temperature Notice

1. Battery capacity is significantly reduced when flying in low-temperature environments of -10° to 5° C (14° to 41° F). It is recommended to hover the aircraft in place for a while to heat the battery. Make sure to fully charge the battery before takeoff.
2. Batteries cannot be used in extremely low-temperature environments of lower than -10° C (14° F).
3. When in low-temperature environments, end the flight as soon as DJI Fly displays the low battery level warning.
4. To ensure the optimal performance of the battery, keep the battery temperature above 20° C (68° F).
5. The reduced battery capacity in low-temperature environments reduces the wind speed resistance performance of the aircraft. Fly with caution.
6. Fly with extra caution at high sea levels.

Charging the Battery

Fully charge the Intelligent Flight Battery before every flight using the provided Mavic 3 Battery Charging Hub and DJI 65W Portable Charger.

Using Charging Hub

When used with the DJI 65W Portable Charger, the DJI Mavic 3 Battery Charging Hub can charge up to three Intelligent Flight Batteries in sequence from high to low power level. The charging time for one battery is approximately 1 hour and 36 minutes.

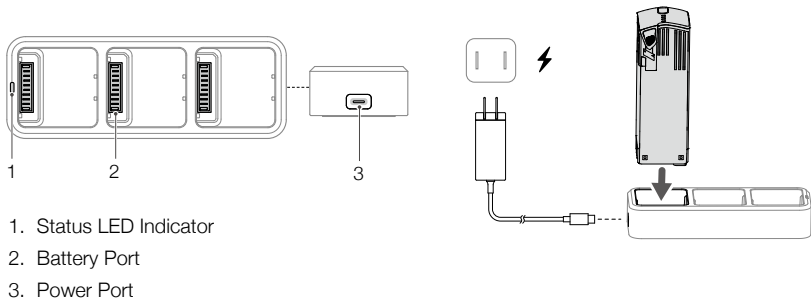

Usage

1. Insert the Intelligent Flight Battery into the battery port. Connect the charging hub to a power outlet (100-240 V, 50-60 Hz) using the DJI 65W Portable Charger.
2. The Intelligent Flight Battery with the highest power level will be charged first and then the rest will be charged in sequence according to their power levels. Refer to the Status LED Indicator Descriptions section for more information about the blinking patterns of the status LED indicator. The Intelligent Flight Battery can be disconnected from the charging hub when charging is complete.

Status LED Indicator Descriptions

Blinking Pattern	Description
Solid yellow	No battery inserted
Pulses green	Charging
Solid green	All batteries fully charged
Blinks yellow	Temperature of batteries too low or too high (no further operation needed)
Solid red	Power supply or battery error (remove and reinsert the batteries or unplug and plug in the charger)



- It is recommended to use a DJI 65W Portable Charger or DJI Mavic 3 Car Charger when using the Mavic 3 Battery Charging Hub to charge Mavic 3 Intelligent Flight Batteries.
- The charging hub is only compatible with BWX260-5000-15.4 Intelligent Flight Batteries. DO NOT attempt to use the charging hub with other battery models.
- Place the charging hub on a flat and stable surface when in use. Make sure the device is properly insulated to prevent fire hazards.
- DO NOT attempt to touch the metal terminals on the product.
- Clean the metal terminals with a clean, dry cloth if there is any noticeable buildup.

Using DJI 65W Portable Charger

1. Connect the DJI 65W Portable Charger to an AC power supply (100-240 V, 50/60 Hz).
2. Attach the aircraft to the charger using the battery charging cable with the battery powered off.
3. The battery level LEDs display the current battery level during charging.
4. The Intelligent Flight Battery is fully charged when all the battery level LEDs are off. Detach the charger when the battery is fully charged.

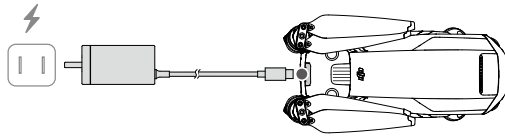

- ⚠ • DO NOT charge an Intelligent Flight Battery immediately after flight as the temperature may be too high. Wait until it cools down to room temperature before charging again.
- The charger stops charging the battery if the battery cell temperature is not within the operating range of 5° to 40° C (41° to 104° F). The ideal charging temperature is 22° to 28° C (71.6° to 82.4° F).
- Fully charge the battery at least once every three months to maintain battery health.
- DJI does not take any responsibility for damage caused by third-party chargers.

- ☀ • It is recommended to discharge the Intelligent Flight Batteries to 30% or lower before transportation. This can be done by flying the aircraft outdoors until there is less than 30% charge left.

The table below shows the battery level during charging.

LED1	LED2	LED3	LED4	Battery Level
☀	☀	○	○	0% < Battery Level ≤ 50%
☀	☀	☀	○	50% < Battery Level ≤ 75%
☀	☀	☀	☀	75% < Battery Level < 100%
○	○	○	○	Fully Charged

Battery Protection Mechanisms

The battery LED indicator can display battery protection prompts triggered by abnormal charging conditions.

Battery Protection Mechanisms					
LED1	LED2	LED3	LED4	Blinking Pattern	Status
○	☀	○	○	LED2 blinks twice per second	Overcurrent detected
○	☀	○	○	LED2 blinks three times per second	Short circuit detected
○	○	☀	○	LED3 blinks twice per second	Overcharge detected
○	○	☀	○	LED3 blinks three times per second	Over-voltage charger detected
○	○	○	☀	LED4 blinks twice per second	Charging temperature is too low
○	○	○	☀	LED4 blinks three times per second	Charging temperature is too high

If the battery protection mechanisms activate, in order to resume charging it is necessary to unplug the battery from the charger and plug it in again. If the charging temperature is abnormal, wait for the charging temperature to return to normal, and the battery will automatically resume charging without requiring to unplug and plug in the charger again.

Inserting the Intelligent Flight Battery

Insert the Intelligent Flight Battery into the battery compartment of the aircraft. Make sure it is mounted securely and that the battery buckles click into place.

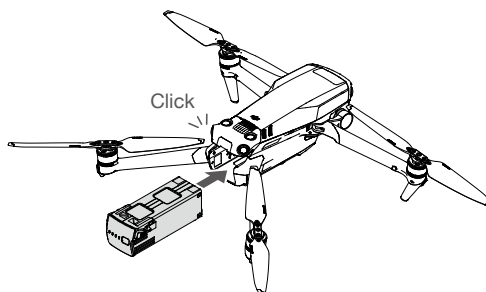

Removing the Intelligent Flight Battery

Press the textured part of the battery buckles on the sides of the Intelligent Flight Battery to remove it from the compartment.

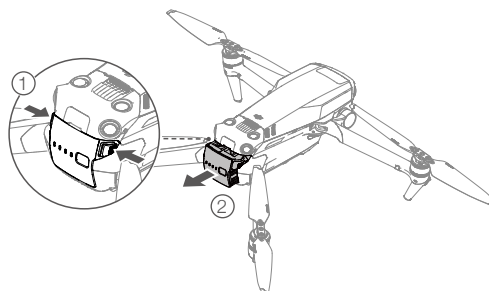

- DO NOT detach the battery when the aircraft is powering on.
 - Make sure that the battery is mounted firmly.
-

Gimbal and Camera

Gimbal Profile

The 3-axis gimbal of DJI Mavic 3 provides stabilization for the camera, allowing you to capture clear and stable images and video. The control tilt range is -90° to $+35^{\circ}$.

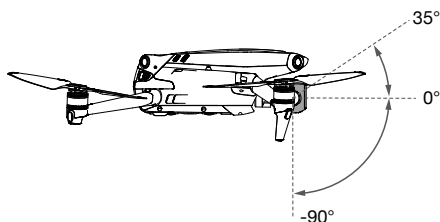

Use the gimbal dial on the remote controller to control the tilt of the camera. Alternatively, enter the camera view in DJI Fly. Press the screen until an adjustment bar appears and drag up and down to control the tilt of the camera.

Gimbal Operation Modes

Two gimbal operation modes are available. Switch between the different operation modes in DJI Fly.

Follow Mode: The angle between the gimbal's orientation and aircraft front remains constant at all times.

FPV Mode: The gimbal synchronizes with the movement of the aircraft to provide a first-person flying experience.



- Do not tap or knock the gimbal when the aircraft is powered on. To protect the gimbal during takeoff, take off from open and flat ground.
- Precision elements in the gimbal may be damaged in a collision or impact, which may cause the gimbal to function abnormally.
- Avoid getting dust or sand on the gimbal, especially in the gimbal motors.
- A gimbal motor may enter protection mode in the following situations:
 - a. The aircraft is on uneven ground or the gimbal is obstructed.
 - b. The gimbal experiences excessive external force, such as during a collision.
- DO NOT apply external force to the gimbal after the gimbal is powered on. DO NOT add any extra payload to the gimbal as this may cause the gimbal to function abnormally or even lead to permanent motor damage.
- Make sure to remove the storage cover before powering on the aircraft. Also, make sure to mount the storage cover when the aircraft is not in use.
- Flying in heavy fog or clouds may make the gimbal wet, leading to temporary failure. The gimbal recovers full functionality once it is dry.

Gimbal Axes Lock

For more convenient storage, the gimbal axes will automatically lock after the aircraft is powered off and unlock when it is powered on again. No user operation is required.



- The gimbal lock function works normally when the operating temperature is -10° to 40° C (14° to 104° F). It may malfunction outside this temperature range and a prompt will appear in DJI Fly if this occurs. If the gimbal lock malfunctions when attempting to unlock the gimbal, users can adjust the gimbal axes manually to unlock the gimbal. It is not recommended to manually adjust the gimbal axes unless necessary.

- If the gimbal lock malfunctions, it will resume normal operation once the operating temperature is -10° to 40° C (14° to 104° F).
 - It is normal for the gimbal to unlock if it is impacted in any way. Restart the aircraft to lock the gimbal again.
 - It is normal for the gimbal to vibrate slightly after it is locked.
-

Camera Profile

DJI Mavic 3 uses a 4/3-in CMOS sensor Hasselblad L2D-20c camera, which can take 20MP photos and record at 5.1K 50fps/DCI 4K 120fps Apple ProRes 422 HQ and H.264/H.265 format videos. The camera also supports 10-bit D-Log video, has an adjustable aperture of f/2.8 to f/11, and can shoot from 1 m to infinity.

The tele camera boasts a 1/2-in CMOS sensor, capable of shooting 12MP photos with an aperture of f/4.4 and shooting from 3 m to infinity. When in Explore mode, the tele camera can zoom at 28x.



- Only DJI Mavic 3 Cine supports Apple ProRes video recording.
 - Make sure the temperature and humidity is suitable for the camera during usage and storage.
 - Use a lens cleanser to clean the lens to avoid damage.
 - DO NOT block any ventilation holes on the camera as the heat generated may damage the device and hurt the user.
 - The cameras may not focus correctly in the following situations:
 - a. Shooting dark objects far away.
 - b. Shooting objects with repeating identical patterns and textures or without clear patterns and textures.
 - c. Shooting shiny or reflective objects (such as street lighting and glass).
 - d. Shooting flashing objects.
 - d. Shooting fast-moving objects.
 - f. When the aircraft/gimbal is moving fast.
 - g. Shooting objects with varying distances in the focus range.
-

Storing Photos and Videos

DJI Mavic 3 has 8 GB of built-in storage and supports the use of a microSD card to store photos and videos. A SDXC or UHS-I microSD card is required due to the fast read and write speeds necessary for high-resolution video data. Refer to the Specifications section for more information about recommended microSD cards.

In addition, DJI Mavic 3 Cine aircraft comes with a built-in 1TB SSD. The footage can be output quickly via the DJI 10Gbps Lightspeed Data Cable.



- Do not remove the microSD card from the aircraft while it is powered on. Otherwise, the microSD card may be damaged.
 - To ensure the stability of the camera system, single video recordings are limited to 30 minutes.
 - Check camera settings before use to ensure they are configured as desired.
 - Before shooting important photos or videos, shoot a few images to test the camera is operating correctly.
 - Photos or videos cannot be transmitted or copied from the camera if the aircraft is powered off.
 - Make sure to power off the aircraft correctly. Otherwise, your camera parameters will not be saved and any recorded videos may be damaged. DJI is not responsible for any failure of an image or video to be recorded or having been recorded in a way that is not machine-readable.
-

Remote Controller

This section describes the features of the remote controller and includes instructions for controlling the aircraft and the camera.

Remote Controller

DJI RC Pro

The DJI RC Pro remote controller features O3+, the latest version of DJI's signature OcuSync image transmission technology, works at both 2.4 and 5.8 GHz, is capable of selecting the best transmission channel automatically, and can transmit a live HD view from the camera of the aircraft at a distance of up to 15 km. The built-in 5.5-in high brightness 1000 cd/m² screen boasts a resolution of 1920×1080 pixels while the remote controller comes with a wide range of aircraft and gimbal controls as well as customizable buttons. Users can connect to the internet via Wi-Fi and the Android 10 operating system comes with a variety of functions such as Bluetooth and GNSS (GPS+GLONASS+Galileo).

With the built-in speaker, the remote controller supports H.264 4K/120fps and H.265 4K/120fps video, which also supports video output via the Mini HDMI port. The internal storage of the remote controller is 32 GB and also supports the use of microSD cards to store the photos and videos.

The 5000 mAh and 36 Wh battery provides the RC Pro with a maximum operating time of 3 hours.

Using the Remote Controller

Powering On/Off

Press the power button once to check the current battery level.

Press and then press again and hold to power the remote controller on or off.

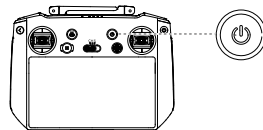

Charging the Battery

Use a USB-C cable to connect the charger to the USB-C port of the remote controller.

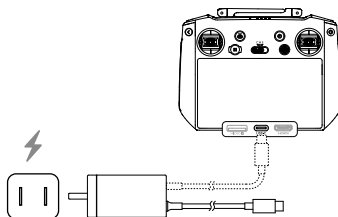

Controlling the Gimbal and Camera

Focus/Shutter Button: Press halfway down to auto focus and press all the way down to take a photo.

Record Button: Press once to start or stop recording.

Camera Control Dial: Use to adjust the zoom.

Gimbal Dial: Use to adjust the tilt of the gimbal.

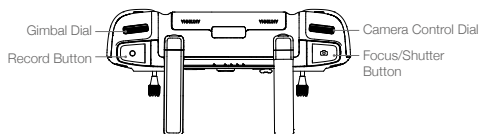

Controlling the Aircraft

Three preprogrammed modes (Mode 1, Mode 2, and Mode 3) are available and custom modes can be configured in DJI Fly. The default mode is Mode 2.

Mode 1

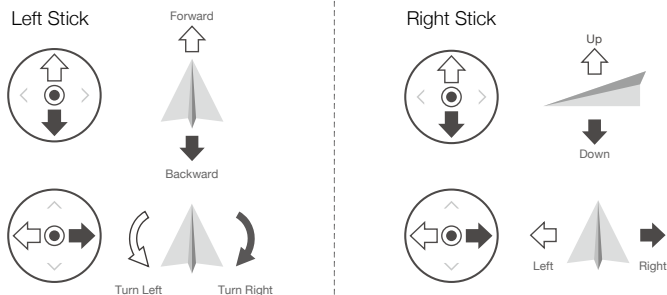



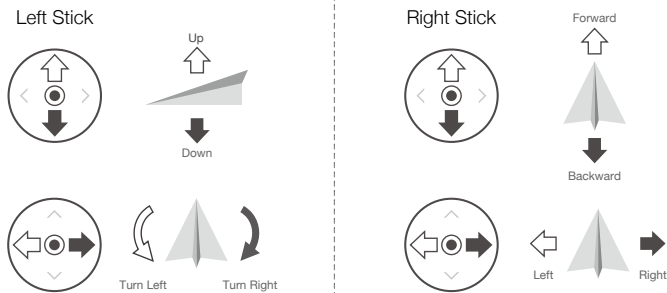

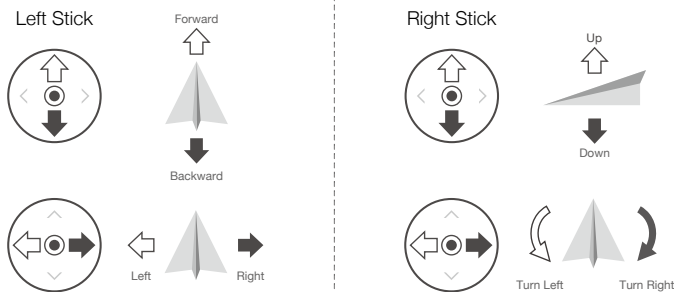

Mode 2

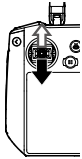
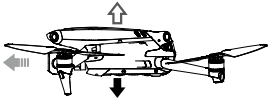

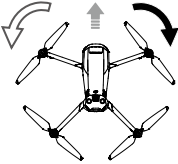
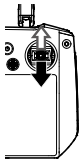
Mode 3

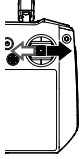

Remote Controller (Mode 2)	Aircraft (← Indicates Nose Direction)	Remarks
		<p>Moving the left stick up or down changes the aircraft's altitude. Push the stick up to ascend and down to descend. The more the stick is pushed away from the center position, the faster the aircraft will change altitude. Push the stick gently to prevent sudden and unexpected changes in altitude.</p>
		<p>Moving the left stick to the left or right controls the orientation of the aircraft. Push the stick left to rotate the aircraft counter-clockwise and right to rotate the aircraft clockwise. The more the stick is pushed away from the center position, the faster the aircraft will rotate.</p>
		<p>Moving the right stick up and down changes the aircraft's pitch. Push the stick up to fly forward and down to fly backward. The more the stick is pushed away from the center position, the faster the aircraft will move.</p>
		<p>Moving the right stick to the left or right changes the aircraft's roll. Push the stick left to fly left and right to fly right. The more the stick is pushed away from the center position, the faster the aircraft will move.</p>

Flight Mode Switch

Toggle the switch to select the flight mode.

Position	Flight Mode
S	Sport Mode
N	Normal Mode
C	Cine Mode

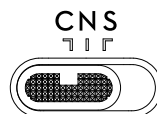

RTH Button

Press and hold the RTH button until the remote controller beeps to start RTH. Press this button again to cancel RTH and regain control of the aircraft. Refer to the Return to Home section for more information about RTH.

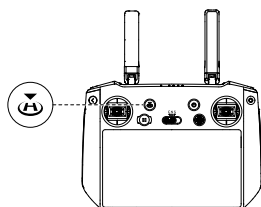

Customizable Buttons

Including C1, C2, and the 5D button. Go to System Settings in DJI Fly and select Control to customize the function of the button.

Combination Buttons

Back + Gimbal Dial: Adjust Brightness

Back + Camera Control Dial: Adjust Volume

Back + Record Button: Record Screen

Back + Shutter Button: Screenshot

Back + 5D Button: Up - Home, Down - Shortcut Settings, Left - Recent

Status LED and Battery Level LEDs Description

Status LED

Blinking Pattern	Descriptions
Solid red	Disconnected with aircraft
Blinks red	The temperature of the remote controller is too high or the battery level of the aircraft is low
Solid green	Connected with aircraft
Blinks blue	The remote controller is linking to an aircraft
Solid yellow	Firmware update failed
Blinks yellow	The battery level of the remote controller is low
Blinks cyan	Control sticks not centered

Battery Level Indicators

Blinking Pattern				Battery Level
●	●	●	●	75%~100%
●	●	●	○	50%~75%
●	●	○	○	25%~50%
●	○	○	○	0%~25%

Remote Controller Alert

The remote controller vibrates or beeps when there is an error or warning. Pay attention when prompts appear on the touchscreen or in DJI Fly. Slide down from the top to select Do Not Disturb or Mute to disable some alerts.

Optimal Transmission Zone

The signal between the aircraft and the remote controller is most reliable when the antennas are positioned in relation to the aircraft as illustrated below.

The optimal transmission range is where the antennas are facing toward the aircraft and the angle between the antennas and the back of the remote controller is 180° or 270°.

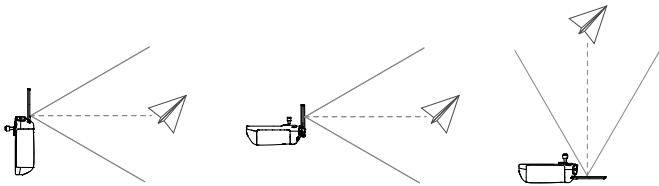

- Do not use other wireless devices operating at the same frequency as the remote controller. Otherwise, the remote controller will experience interference.
 - A prompt will be received in DJI Fly if the transmission signal is weak during flight. Adjust the antennas to make sure that the aircraft is in the optimal transmission range.
-

Linking the Remote Controller

The aircraft and remote controller must be linked before use. Follow these steps to link a new remote controller.

Method 1:

1. Power on the remote controller and the aircraft.
2. Press the C1, C2, and record button simultaneously until the status LED blinks blue and the remote controller beeps.
3. Press and hold the power button of the aircraft for more than four seconds. The aircraft beeps once to indicate it is ready to link. The aircraft beeps twice to indicate linking is successful. The battery level LEDs of the remote controller will glow solid.

Method 2:

1. Power on the remote controller and the aircraft.
2. Launch DJI Fly.
3. In camera view, tap ●●● and select Control and Pair to Aircraft (Link).
4. Press and hold the power button of the aircraft for more than four seconds. The aircraft beeps once indicating it is ready to link. The aircraft beeps twice indicating linking is successful. The battery level LEDs of the remote controller will glow solid.

Touchscreen Operations

Home

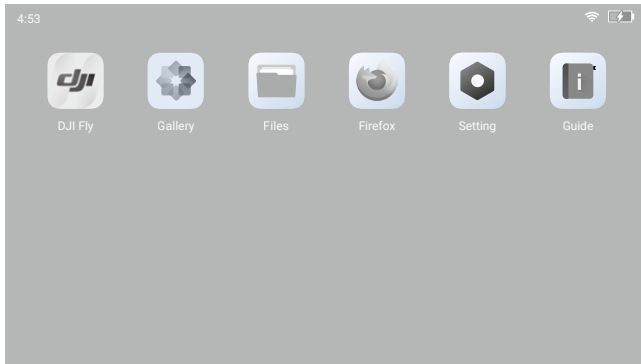

The top of the touchscreen displays the time, Wi-Fi signal, and battery level of the remote controller. Some apps are already installed by default such as DJI Fly, Gallery, Files, Firefox, Settings, and Guide. Settings includes network, display, voice, and Bluetooth configurations. Users can quickly learn about the features under Guide.

Operations

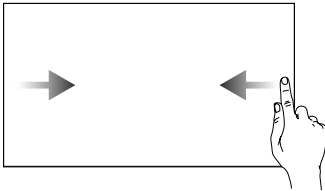

Slide from the left or right to the center of the screen to return to the previous screen.

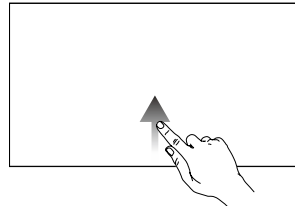

Slide up from the bottom of the screen and release to return to the home screen.

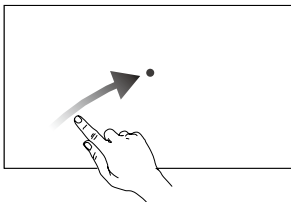

Slide diagonally right from the bottom of the screen and hold to access recently opened apps when on the home screen.

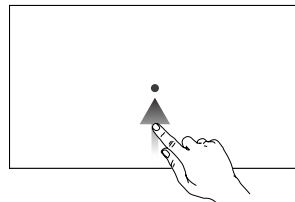

Slide up from the bottom of the screen and hold to access recently opened apps when not on the home screen.

Quick Settings

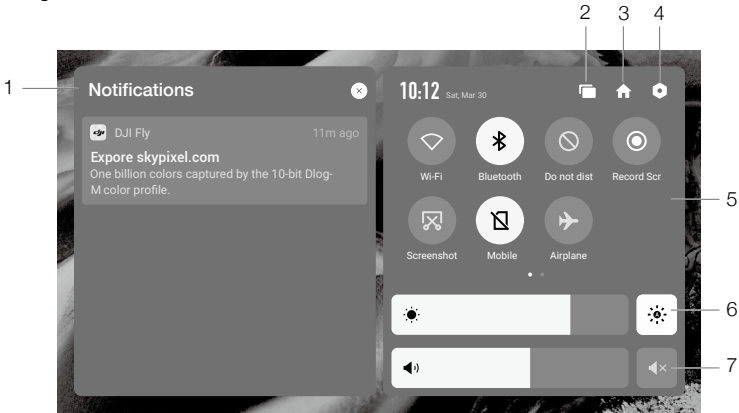

1. Notifications

Tap to check system notifications.

2. Recent

Tap to check recently opened apps.

3. Home

Tap to return to the home screen.

4. System Settings

Tap to access system settings.

5. Shortcuts

Wi-Fi : Tap to enable or disable Wi-Fi. Hold to enter settings and connect to or add a Wi-Fi network.

Bluetooth : Tap to enable or disable Bluetooth. Hold to enter settings and connect with nearby Bluetooth devices.

Do Not Disturb : Tap to enable Do Not Disturb mode. In this mode, system prompts will be disabled.

Record Screen : Tap to start recording the screen. While recording, the screen displays the recording time. Tap to stop recording.

Screenshot : Tap to screenshot the screen.

Mobile : Mobile data.

Airplane : Tap to enable Airplane mode. Wi-Fi, Bluetooth, and mobile data will be disabled.

6. Adjusting Brightness

Brightness : The screen is in auto brightness mode when the icon is highlighted. Tap this icon or slide the bar and the icon will switch to manual brightness mode.

7. Adjusting Volume

Volume : Slide the bar to adjust the volume and tap to mute.

Advanced Feature

Calibrating the Compass

The compass may need to be calibrated after the remote controller is used in areas with electromagnetic interference. A warning prompt will appear if the compass of the remote controller requires calibration. Tap the warning prompt to start calibrating. In other cases, follow the steps below to calibrate your remote controller.

1. Enter the home screen.
2. Select Settings, scroll down, and tap Compass.
3. Follow the diagram on the screen to calibrate your remote controller.
4. The user will receive a prompt when the calibration is successful.

HDMI Settings

The touchscreen can be shared to a display after connecting the HDMI port of the remote controller. The resolution can be set by entering Settings, Display, and then Advanced HDMI.

RC-N1

Built into the remote controller is DJI'S long-range transmission technology, offering a maximum transmission range of 15 km and displaying video from the aircraft to DJI Fly on a mobile device at up to 1080p 60fps (depending on phone type). The aircraft and camera are easy to control using the onboard buttons and the detachable control sticks make the remote controller easier to store.

In a wide-open area with no electromagnetic interference, the aircraft uses O3+ to smoothly transmit video links at up to 1080p 60fps (depending on phone type). The remote controller works at both 2.4 GHz and 5.8 GHz, automatically selecting the best transmission channel.

The built-in battery has a capacity of 5200 mAh and energy of 18.72 Wh and a maximum run time of 6 hours. The remote controller charges the mobile device with a charging ability of 500 mA@5 V. The remote controller automatically charges Android devices. For iOS devices, first make sure that charging is enabled in DJI Fly. Charging for iOS devices is disabled by default and needs to be enabled each time the remote controller is powered on.



- Compliance Version: The remote controller is compliant with local regulations.
- Control Stick Mode: The control stick mode determines the function of each control stick movement. Three pre-programmed modes (Mode 1, Mode 2, and Mode 3) are available and custom modes can be configured in DJI Fly. The default mode is Mode 2.

Using the Remote Controller

Powering On/Off

Press the power button once to check the current battery level. Press once, then again, and hold to power the remote controller on or off. If the battery level is too low, recharge before use.

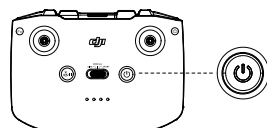

Charging the Battery

Use a USB-C cable to connect the provided charger to the USB-C port of the remote controller. It takes approximately four hours to fully charge the remote controller.

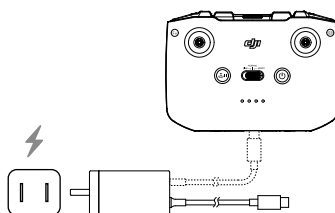

Controlling the Gimbal and Camera

Shutter/Record Button: Press once take a photo or to start or stop recording.

Photo/Video Toggle: Press once to switch between photo and video mode.

Gimbal Dial: Use to control the tilt of the gimbal.

Press and hold the customizable button in order to be able to use the gimbal dial to adjust the zoom in explore mode.

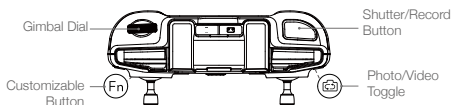

Controlling the Aircraft

The control sticks control the aircraft's orientation (pan), forward/backward movement (pitch), altitude (throttle), and left/right movement (roll). The control stick mode determines the function of each control stick movement. Three preprogrammed modes (Mode 1, Mode 2, and Mode 3) are available and custom modes can be configured in DJI Fly. The default mode is Mode 2.

Mode 1

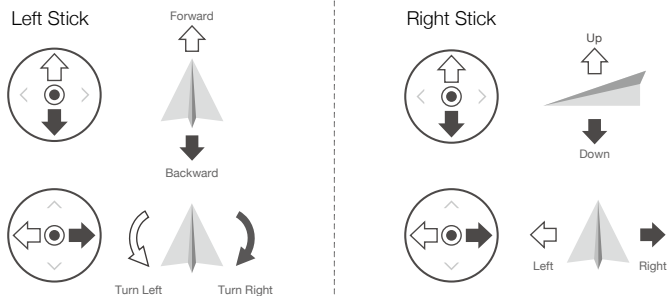



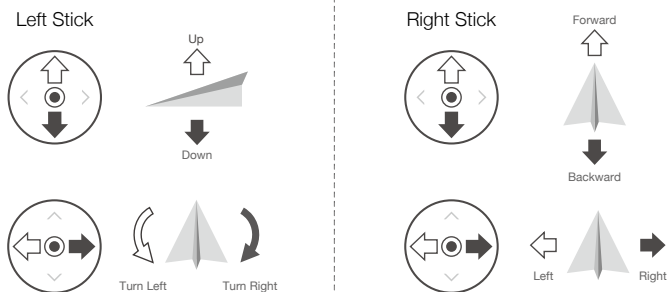

Mode 2

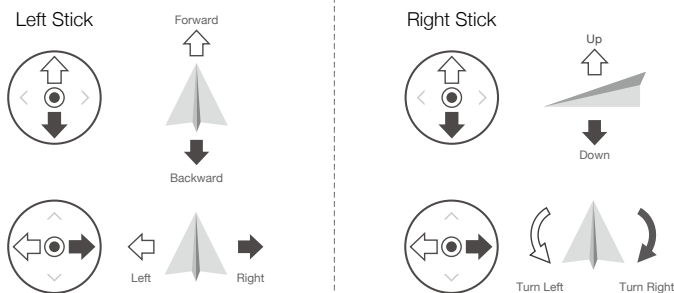

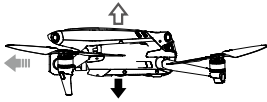
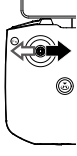
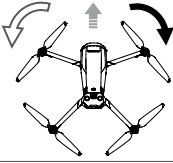
Mode 3

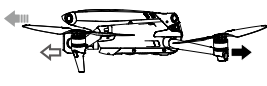

Remote Controller (Mode 2)	Aircraft (← Indicates Nose Direction)	Remarks
		Moving the left stick up or down changes the aircraft's altitude. Push the stick up to ascend and down to descend. The more the stick is pushed away from the center position, the faster the aircraft will change altitude. Push the stick gently to prevent sudden and unexpected changes in altitude.
		Moving the left stick to the left or right controls the orientation of the aircraft. Push the stick left to rotate the aircraft counter-clockwise and right to rotate the aircraft clockwise. The more the stick is pushed away from the center position, the faster the aircraft will rotate.
		Moving the right stick up and down changes the aircraft's pitch. Push the stick up to fly forward and down to fly backward. The more the stick is pushed away from the center position, the faster the aircraft will move.
		Moving the right stick to the left or right changes the aircraft's roll. Push the stick left to fly left and right to fly right. The more the stick is pushed away from the center position, the faster the aircraft will move.

Flight Mode Switch

Toggle the switch to select the flight mode.

Position	Flight Mode
S	Sport Mode
N	Normal Mode
C	Cine Mode

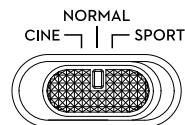

Flight Pause/RTH Button

Press once to make the aircraft brake and hover in place. If the aircraft is performing Smart RTH or auto landing, press once to exit the procedure and then brake.

Press and hold the RTH button until the remote controller beeps to start RTH. Press this button again to cancel RTH and regain control of the aircraft. Refer to the Return to Home section for more information about RTH.

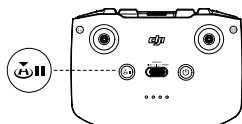

Customizable Button

Go to System Settings in DJI Fly and select Control to customize the function of the button. Functions include recentering the gimbal, switching the auxiliary LED, and enabling Cruise Control.

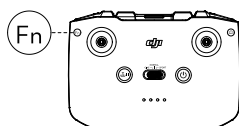

Remote Controller Alert

The remote controller sounds an alert during RTH or when the battery level is low (6% to 15%). The low battery alert level can be cancelled by pressing the power button. The critical battery level alert (less than 5%), however, cannot be cancelled.

Optimal Transmission Zone

The signal between the aircraft and the remote controller is most reliable when the antennas are positioned in relation to the aircraft as depicted below.

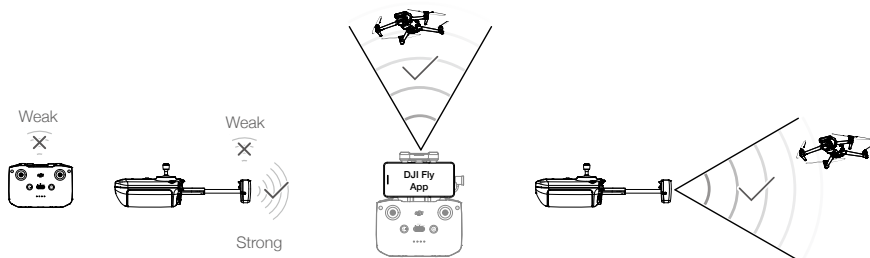

Optimal Transmission Zone

Linking the Remote Controller

The aircraft and remote controller must be linked before using. Follow these steps to link a new remote controller:

1. Power on the remote controller and the aircraft.
2. Launch DJI Fly.
3. In camera view, tap ●●● and select Control and Pair to Aircraft (Link).
4. Press and hold the power button of the aircraft for more than four seconds. The aircraft beeps once indicating it is ready to link. The aircraft beeps twice indicating linking is successful. The battery level LEDs of the remote controller will glow solid.



- Make sure the remote controller is within 0.5 m of the aircraft during linking.
- The remote controller will automatically unlink from an aircraft if a new remote controller is linked to the same aircraft.



- Fully charge the remote controller before each flight. The remote controller sounds an alert when the battery level is low.
 - If the remote controller is powered on and not in use for five minutes, an alert will sound. After 6 minutes, the remote controller automatically powers off. Move the control sticks or press any button to cancel the alert.
 - Adjust the mobile device holder to ensure the mobile device is secure.
 - Fully charge the battery at least once every three months to maintain battery health.
-

DJI Fly App

This section introduces the main functions of the DJI Fly app.

DJI Fly App

Home

Launch DJI Fly and enter the home screen.

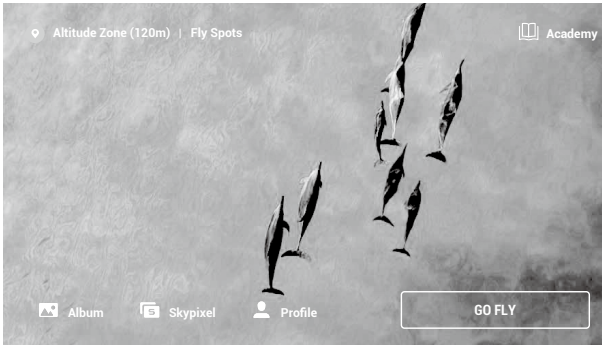

Fly Spots

View or share nearby suitable flight and shooting locations, learn more about GEO zones, and preview aerial photos of different locations taken by other users.

Academy

Tap the icon in the top right corner to enter Academy. Product tutorials, flight tips, flight safety, and manual documents can be viewed here.

Album

Allows you to view photos and videos from DJI Fly and mobile device. Create contains Templates and Pro. Templates provides auto edit feature for imported footage. Pro allows you to edit the footage manually.

SkyPixel

Enter SkyPixel to view videos and photos shared by users.

Profile

View the account information, flight records, DJI forum, online store, Find My Drone feature, and other settings.

Camera View

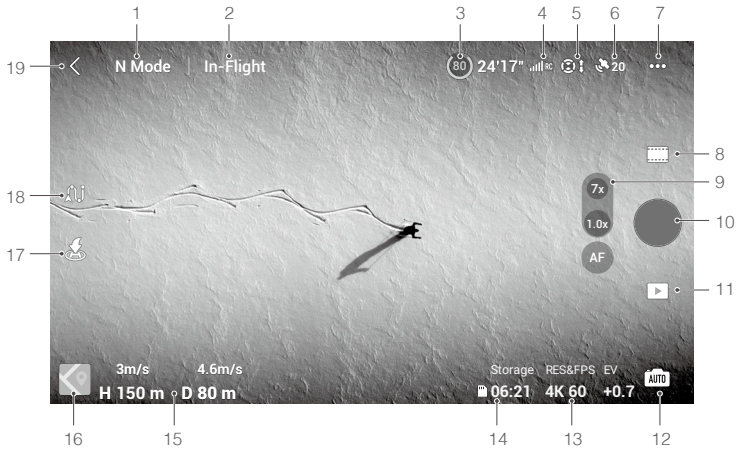

1. Flight Mode

N : Displays the current flight mode.

2. System Status Bar

In-Flight : Indicates aircraft flight status and displays various warning messages.

3. Battery Information

(80) 24'17'' : Displays the current battery level and remaining flight time. Tap to view more information about the battery.

4. Video Downlink Signal Strength

📶 : Displays the video downlink strength between the aircraft and remote controller.

5. Vision Systems Status

👁️ : The left side of the icon indicates the status of the Forward, Backward, and Lateral Vision Systems and the right side of the icon indicates the status of the Upward and Downward Vision Systems. The icon is white when the vision system is working normally and red when the vision system is unavailable.

6. GNSS Status

📶 20 : Displays the current GNSS signal strength. Tap to check the GNSS signal status. The Home Point can be updated when the icon is white, which indicates the GNSS signal is strong.

7. System Settings

⋮ : Tap to view information about safety, control, and transmission.

Safety

Flight Assistance: Upward, Forward, Backward, and the Lateral vision systems are enabled after setting Obstacle Avoidance to Bypass or Brake. The aircraft cannot sense obstacles if Obstacle Avoidance is disabled. Select Normal or Nifty mode when using Bypass.

Radar Map Display: When enabled, the real-time obstacle detection radar map will be displayed.

Return to Home: Tap to set Advanced RTH, Auto RTH Altitude (default altitude is 100 m), and to update the Home Point.

Flight Protection: Tap to set the max altitude and max distance, Auto RTH altitude (default altitude is 100 m), and to update the Home Point.

Sensors: Tap to view the IMU and compass status and start to calibrate if necessary.

Battery: Tap to view the battery information such as battery cell status, serial number and times charged.

Auxiliary LED: Tap to set the auxiliary LED to auto, on, or off. Do not turn on the Auxiliary LED before takeoff.

Aircraft Front Arm LEDs: In auto mode, the aircraft front LEDs will be disabled during recording to ensure the quality is not affected.

Unlock GEO Zone: Tap to view the information about unlocking GEO zones.

The Find My Drone feature helps to find the location of the aircraft on the ground.

Advanced Safety Settings include the behavior settings of the aircraft when the remote controller signal is lost, when the propellers can be stopped during flight, and the AirSense switch.

The behavior of the aircraft when the remote controller signal is lost can be set to Return to Home, Descend, and Hover.

“Emergency Only” indicates that the motors can only be stopped mid-flight in an emergency situation such as if there is a collision, a motor has stalled, the aircraft is rolling in the air, or the aircraft is out of control and is ascending or descending very quickly. “Anytime” indicates that the motors can be stopped mid-flight anytime once user performs a combination stick command (CSC). Stopping the motors in mid-flight will cause the aircraft to crash.

An alert will appear in DJI Fly when a manned aircraft is detected if AirSense is enabled. Read the disclaimer in the DJI Fly prompt before using AirSense.

Control

Aircraft Settings

Unit	Can be set to metric or imperial.
Subject Scanning	When enabled, aircraft automatically scans and displays subjects in the Camera View (only available for single-shot photos and normal video recording).
Gain and Expo Tuning	Supports the gain and expo settings to be fine-tuned on the aircraft and the gimbal in different flight modes, including the max horizontal speed, max ascent speed, max descent speed, max angular velocity, yaw smoothness, brake sensitivity, and expo and the gimbal max tilt control speed and tilt smoothness.



- When releasing the control sticks, an increased brake sensitivity reduces the braking distance of the aircraft, while a decreased brake sensitivity increases the braking distance. Fly with caution.

Gimbal Settings: Tap to set the gimbal mode, advanced settings, gimbal angle, and perform gimbal calibration.

Remote Controller Settings: Tap to set the function of the customizable button, to calibrate the remote controller, and to switch stick modes. Make sure to understand the operations of a stick mode before changing stick mode.

Beginner Flight Tutorial: View the flight tutorial.

Connect to Aircraft: Tap to start linking when the aircraft is not linked to the remote controller.

Camera

Camera Parameter Settings: Displays different settings according to the shooting mode.

General Settings: Tap to view and set histogram, overexposure warning, gridlines, peaking level, white balance, auto sync HD photos, and cache when recording.

Storage Location: Footage can be stored in the aircraft or on a microSD card. Internal storage and microSD cards can be formatted. The max video cache capacity settings and camera reset settings can also be adjusted.

USB Mode: Mavic 3 Cine supports USB mode, enabling users to copy footage when the battery level of the aircraft is low. Enable USB mode, power on the aircraft, and connect to a computer to use USB mode. During this time, the internal storage of the aircraft can be accessed but the SD card cannot.

Restart the aircraft and disable USB mode in DJI Fly to exit USB mode. USB mode will be enabled once again when the aircraft is restarted if it was disabled via DJI Assistant 2.



- In USB mode, the aircraft will disconnect from the remote controller, the frame arm light will turn off, and the fan inside the aircraft will stop.

Transmission

Live Stream Platform, HDMI Output, Frequency, and Channel Mode settings.

About

View device information, firmware information, app version, battery version, and more. Tap Reset All Settings to reset settings including camera, gimbal and safety settings to default. Tap Clear All Data to reset all settings to default, and delete all the data stored in internal storage, microSD card and SSD, including flight log. It is recommended to provide proof (flight log) when claiming compensation. Contact DJI support before clearing the flight log if an accident occurs during flight.

8. Shooting Modes

Video: Normal, Explore, Night, and Slow Motion. Supported digital zoom for normal video mode. In Explore mode, the icon shows the zoom ratio, and tap to adjust the zoom ratio. The larger the zoom ratio, the slower the aircraft will rotate. Night mode provides better noise reduction and cleaner footage, supports up to 12800 ISO.



- Night mode currently supports 4K 30fps.
- Obstacle avoidance will be disabled in Night mode. Fly with caution.
- Night mode will be exited automatically when RTH or landing is started.
- During RTH or auto landing, Night mode is not available.
- FocusTrack is not supported in Night mode.

Photo: Single, Explore, Burst Shooting, AEB, and Timed Shot.

MasterShots: Select a subject. The aircraft will record while executing different maneuvers in sequence and keeping the subject in the center of the frame. A short cinematic video will be generated afterward.

QuickShots: Dronie, Rocket, Circle, Helix, Boomerang, and Asteroid.

Hyperlapse: Choose from Free, Circle, Course Lock, and Waypoints.

Pano: Choose from Sphere, 180°, Wide Angle, and Vertical.

9. Tele Camera

Tap to switch to tele camera in Photo or Video mode. Single, AEB, Burst, Time Shot photo mode, and JPEG, RAW, and J+R format are supported, and ISO and shutter speed can be set manually in Photo mode. 4K 25/30/50fps and 1080p 25/30/50fps format is supported, and ISO and shutter speed can be set manually in Video mode. Spotlight and POI can be used when using tele camera at 7x ratio, supports static subject. Tap to switch to wide angle camera.

10. Shutter/Record Button



: Tap to take a photo or to start or stop recording a video.

11. Playback



: Tap to enter playback and preview photos and videos as soon as they are captured.

12. Camera Modes Switch



: Choose between Auto and Pro mode when in photo mode. Different parameters can be set in different modes.

13. Shooting Parameters



: Displays the current shooting parameters. Tap to access parameter settings.

14. Storage Information



: Displays the remaining number of photos or video recording time of the current storage. Tap to view the available capacity of the SSD or microSD card.

15. Flight Telemetry

D 80m H 150m 4.6m/s 3m/s : Displays the distance between the aircraft and the Home Point, height from the Home Point, aircraft horizontal speed, and aircraft vertical speed.

16. Map

 : Tap to switch to the Attitude Indicator, which displays information such as the orientation and tilt angle of the aircraft, position of the remote controller, and position of the Home Point.

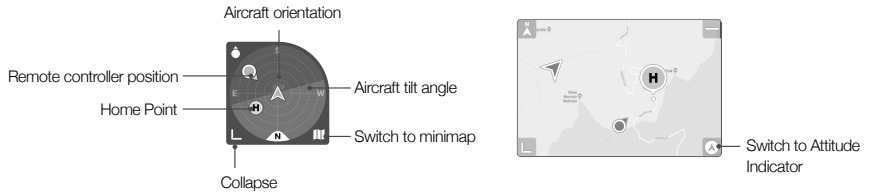

17. Auto Takeoff/Landing/RTH

 : Tap the icon. When the prompt appears, press and hold the button to initiate auto takeoff or landing.

 : Tap to initiate Smart RTH and have the aircraft return to the last recorded Home Point.

18. Waypoint Flight

 : Tap to enable/disable Waypoint Flight.

19. Back

 : Tap to return to the home screen.

Press and hold on the screen to bring up the gimbal adjustment bar to adjust the gimbal angle.

Tap on the screen to enable focus or spot metering. Focus or spot metering will display differently depending on the focus mode, exposure mode, and spot metering mode. After using spot metering, press and hold on the screen to lock the exposure. To unlock the exposure, press and hold on the screen again.



- Make sure to fully charge your device before launching DJI Fly.
- Mobile cellular data is required when using DJI Fly. Contact your wireless carrier for data charges.
- If you are using a mobile phone as your display device, DO NOT accept phone calls or use texting features during flight.
- Read all safety tips, warning messages, and disclaimers carefully. Familiarize yourself with the related regulations in your area. You are solely responsible for being aware of all relevant regulations and flying in a way that is compliant.
 - a. Read and understand the warning messages before using the auto-take off and auto-landing.
 - b. Read and understand the warning messages and disclaimer before setting the altitude beyond the default limit.
 - c. Read and understand the warning messages and disclaimer before switching between flight modes.
 - d. Read and understand the warning messages and disclaimer prompts near or in GEO zones.
 - e. Read and understand the warning messages before using the Intelligent Flight modes.
- Land the aircraft immediately in a safe location if prompted to do so in the app.
- Review all warning messages on the checklist displayed in the app before each flight.
- Use the in-app tutorial to practice your flight skills if you have never operated the aircraft or if you do not have sufficient experience to operate the aircraft with confidence.
- Cache the map data of the area where you intend to fly the aircraft by connecting to the internet before each flight.
- The app is designed to assist your operation. Use your sound discretion and DO NOT rely on the app to control your aircraft. Your use of the app is subject to DJI Fly Terms of Use and DJI Privacy Policy. Read them carefully in the app.

Flight

This section describes safe flight practices and flight restrictions.

Flight

Once pre-flight preparation is complete, it is recommended to hone your flight skills and practice flying safely. Make sure that all flights are carried out in an open area. Refer to the Remote Controller and DJI Fly sections for information about using the remote controller and the app to control the aircraft.

Flight Environment Requirements

1. Do not use the aircraft in severe weather conditions including wind speeds exceeding 12 m/s, snow, rain, and fog.
2. Only fly in open areas. Tall structures and large metal structures may affect the accuracy of the onboard compass and GNSS system. It is recommended to keep the aircraft at least 5 m away from structures.
3. Avoid obstacles, crowds, high voltage power lines, trees, and bodies of water. It is recommended to keep the aircraft at least 3 m above water.
4. Minimize interference by avoiding areas with high levels of electromagnetism such as locations near power lines, base stations, electrical substations, and broadcasting towers.
5. Aircraft and battery performance is subject to environmental factors such as air density and temperature. Be careful when flying 6,000 m or more above sea level, since battery and aircraft performance may be reduced.
6. Aircraft cannot use GNSS within the polar regions. Use the Downward Vision System when flying in such locations.
7. DO NOT take off from moving objects such as cars, ships, and airplanes.
8. DO NOT use the aircraft, remote controller, battery, and battery charger near accidents, fires, explosions, floods, tsunamis, avalanches, landslides, earthquakes, dust, or sandstorms.
9. Use the battery charger in a temperature range of 5° to 40° C (41° to 104° F).
10. Operate the aircraft, battery, remote controller, and battery charger in a dry environment.
11. DO NOT use the battery charger in humid environments.

Operating the Aircraft Responsibly

To avoid serious injury and property damage, observe the following rules:

1. Make sure you are NOT under the influence of anesthesia, alcohol, or drugs or suffering from dizziness, fatigue, nausea, or other conditions that could impair the ability to operate the aircraft safely.
2. When landing, power off the aircraft first, then switch off the remote controller.
3. DO NOT drop, launch, fire, or otherwise project any dangerous payloads on or at any buildings, persons, or animals, which could cause personal injury or property damage.
4. DO NOT use an aircraft that has been crashed or accidentally damaged or an aircraft that is not in good condition.
5. Make sure to train sufficiently and have contingency plans for emergencies or when an incident occurs.
6. Make sure to have a flight plan. DO NOT fly the aircraft recklessly.
7. Respect the privacy of others when using the camera. Make sure to comply with local privacy laws, regulations, and moral standards.
8. DO NOT use this product for any reason other than general personal use.
9. DO NOT use it for illegal or inappropriate purposes such as spying, military operations, or unauthorized investigations.
10. DO NOT use this product to defame, abuse, harass, stalk, threaten, or otherwise violate legal rights such as the right to privacy and publicity of others.
11. DO NOT trespass onto the private property of others.

Flight Limits and GEO Zones

Unmanned aerial vehicle (UAV) operators should abide by the regulations from self-regulatory organizations such as the International Civil Aviation Organization, the Federal Aviation Administration, and local aviation authorities. For safety reasons, flight limits are enabled by default to help users operate this aircraft safely and legally. Users can set flight limits on height and distance.

Altitude limits, distance limits, and GEO zones function concurrently to manage flight safety when GNSS is available. Only altitude can be limited when GNSS is unavailable.

Flight Altitude and Distance Limits

The flight altitude and distance limits can be changed in DJI Fly. Based on these settings, the aircraft will fly in a restricted cylinder, as shown below:

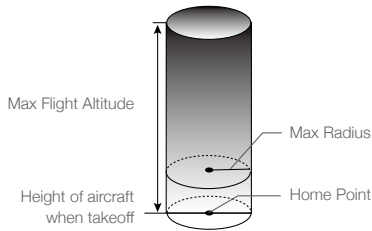

When GNSS is available

	Flight Limits	DJI Fly App
Max Altitude	Aircraft's altitude cannot exceed the specified value	Warning: Height limit reached
Max Radius	Flight distance must be within the max radius	Warning: Distance limit reached

Only Downward Vision System is available

	Flight Limits	DJI Fly App
Max Altitude	Height is restricted to 30 m when the GNSS signal is weak. Height is restricted to 3 m when the GNSS signal is weak and light conditions is not sufficient.	Warning: Height limit reached.
Max Radius	The restrictions on the radius are disabled and warning prompts cannot be received in the app.	



- The altitude limit when the GNSS is weak will not be restricted if there was a strong GNSS signal when the aircraft was powered on.
- If the aircraft reaches a limit, you can still control the aircraft, but you cannot fly it any further. If the aircraft flies out of the max radius, it will automatically fly back within range when the GNSS signal is strong.
- For safety reasons, do not fly close to airports, highways, railway stations, railway lines, city centers, or other sensitive areas. Fly the aircraft only within your line of sight.

GEO Zones

All GEO zones are listed on the DJI official website at <http://www.dji.com/flysafe>. GEO zones are divided into different categories and include locations such as airports, flying fields where manned aircraft operate at low altitudes, borders between countries, and sensitive locations such as power plants. There will be prompts in the DJI Fly app to fly in GEO zones.

Pre-Flight Checklist

1. Make sure the remote controller, mobile device, and Intelligent Flight Battery are fully charged.
2. Make sure the Intelligent Flight Battery and the propellers are mounted securely.
3. Make sure the aircraft arms are unfolded.
4. Make sure the gimbal and camera are functioning normally.
5. Make sure that there is nothing obstructing the motors and that they are functioning normally.
6. Make sure that DJI Fly is successfully connected to the aircraft.
7. Make sure that the camera lens and Vision System sensors are clean.
8. Use only genuine DJI parts or parts certified by DJI. Unauthorized parts or parts from non-DJI certified manufacturers may cause system malfunctions and compromise safety.
9. Check if the Remote ID is up to date and working.
10. Make sure the max flight altitude is set properly according to local regulations.
11. DO NOT fly over a density population.
12. Make sure the aircraft and remote controller are functioning normally.

Auto Takeoff/Landing



Auto Takeoff

Use auto takeoff:

1. Launch DJI Fly and enter the camera view.
2. Complete all steps in the pre-flight checklist.
3. Tap . If conditions are safe for takeoff, press and hold the button to confirm.
4. The aircraft will take off and hover 1.2 m above the ground.

Auto Landing

Use auto landing:

1. Tap . If conditions are safe to land, press and hold the button to confirm.
2. Auto landing can be cancelled by tapping .
3. If the Vision System is working normally, Landing Protection will be enabled.
4. Motors stops after landing.

Starting/Stopping the Motors

Starting the Motors

A Combination Stick Command (CSC) is used to start the motors. Push both sticks to the bottom inner or outer corners to start the motors. Once the motors have started spinning, release both sticks simultaneously.

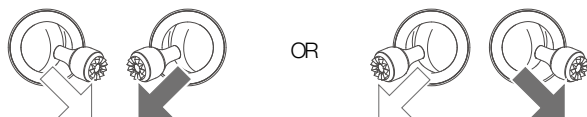

Stopping the Motors

There are two methods to stop the motors.

Method 1: When the aircraft has landed, push and hold the left stick down. The motors will stop after one second.

Method 2: When the aircraft has landed, perform the same CSC that was used to start the motors. The motors will stop after two seconds. Release both sticks once the motors have stopped.

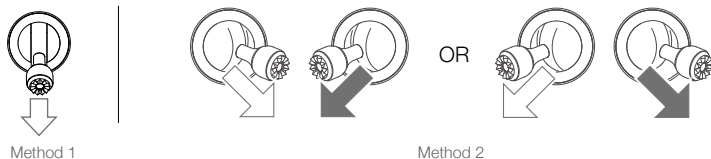

• If the motor is started unexpectedly, use CSC to stop motors immediately.

Stopping the Motors Mid-Flight

Stopping motors mid-flight will cause the aircraft to crash. The motors should only be stopped mid-flight in an emergency situation such as if a collision has occurred or if the aircraft is out of control and is ascending or descending very quickly, rolling in the air, or if a motor has stalled. To stop the motors mid-flight use the same CSC that was used to start the motors. The default setting can be changed in DJI Fly.

Flight Test

Takeoff/Landing Procedures

1. Place the aircraft in an open, flat area with the aircraft status indicator facing towards you.
2. Turn on the aircraft and the remote controller.
3. Launch DJI Fly and enter the camera view.
4. Wait until the self-check is finished, it is safe to fly if there is no abnormal warning in DJI Fly.
5. Gently push the throttle stick to take off or use auto-takeoff.
6. Pull the throttle stick or use auto-landing to land the aircraft.
7. After landing, push the throttle stick down and hold. The motors stop after one second.
8. Turn off the aircraft and remote controller.

Video Suggestions and Tips

1. The pre-flight checklist is designed to help you fly safely and to ensure that you can shoot video during flight. Go through the full pre-flight checklist before each flight.
2. Select the desired gimbal operation mode in DJI Fly.
3. Use Normal or Cine mode to record video.
4. DO NOT fly in bad weather conditions such as when it is raining or windy.
5. Choose the camera settings that best suit your needs.
6. Perform flight tests to establish flight routes and to preview scenes.



- Make sure to place the aircraft on a flat and steady surface before takeoff. DO NOT takeoff from your palm or while holding the aircraft with your hand.
-

Appendix

Appendix

Specifications

Aircraft	
Takeoff Weight	895 g (Mavic 3) 899 g (Mavic 3 Cine)
Dimensions (L×W×H)	Folded: 221×96.3×90.3 mm Unfolded: 347.5×283×107.7 mm
Diagonal Distance	380.1 mm
Max Ascent Speed	S Mode: 8 m/s N Mode: 6 m/s C Mode: 1 m/s
Max Descent Speed	S Mode: 6 m/s N Mode: 6 m/s C Mode: 1 m/s
Max Speed (near sea level, no wind)	S Mode: 21 m/s; S Mode (EU): 19 m/s N Mode: 15 m/s C Mode: 5 m/s
Max Service Ceiling Above Sea Level	6,000 m
Max Flight Time	46 min (measured while flying at 32.4 kph in windless conditions)
Max Hover Time (without wind)	40 min
Max Flight Distance	30 km
Max Wind Speed Resistance	12 m/s
Max Tilt Angle	S Mode: 35° N Mode: 30° C Mode: 25°
Max Angular Velocity	200°/s
Operating Temperature	-10° to 40° C (14° to 104° F)
GNSS	GPS + Galileo + BeiDou
Hovering Accuracy Range	Vertical: Vision Positioning: ±0.1 m GNSS Positioning: ±0.5 m Horizontal: Vision Positioning: ±0.3 m High Accuracy System Positioning: ±0.5 m
Internal Storage	Mavic 3: 8 GB (7.9 GB of available storage) Mavic 3 Cine: 1 TB (934.8 GB of available storage)
Hasselblad Camera	
Sensor	4/3 CMOS Effective Pixels: 20 MP
Lens	FOV: 84° Format Equivalent: 24 mm Aperture: f/2.8-f/11 Shooting Range: 1 m to ∞ (with auto focus)
ISO Range	Video Normal and Slow Motion; 100-6400 (Normal) 400-1600 (D-Log) 100-1600 (HLG) Night: 800-12800 (Normal) Photo: 100-6400

Electronic Shutter Speed	1/8000-8 s
Max Image Size	5280 × 3956
Still Photography Modes	Single: 20 MP Automatic Exposure Bracketing (AEB): 20 MP, 3/5 Frames at 0.7EV Step Timed: 20 MP 2/3/5/7/10/15/20/30/60 seconds
Video Resolution	Apple ProRes 422 HQ /422/422LT* 5.1K: 5120 × 2700@24/25/30/48/50fps DCI 4K: 4096 × 2160@24/25/30/48/50/60/120**fps 4K: 3840 × 2160@24/25/30/48/50/60/120**fps H.264/H.265 5.1K: 5120 × 2700@24/25/30/48/50fps DCI 4K: 4096 × 2160@24/25/30/48/50/60/120**fps 4K: 3840 × 2160@24/25/30/48/50/60/120**fps FHD: 1920 × 1080@24/25/30/48/50/60/120**/200**fps * Only DJI Mavic 3 Cine supports Apple ProRes video recording. ** Recorded frame rate, corresponding video plays as slow motion video
Max Video Bitrate	H.264/H.265: 200Mbps
Supported File System	exFAT
Photo Format	JPEG/DNG (RAW)
Video Format	Mavic 3: MP4/MOV (MPEG-4 AVC/H.264, HEVC/H.265) Mavic 3 Cine: MP4/MOV (MPEG-4 AVC/H.264, HEVC/H.265) MOV (Apple ProRes 422 HQ)
Color Mode	Normal/HLG/D-Log
Tele Camera	
Sensor	1/2-in CMOS
Lens	FOV: 15° Format Equivalent: 162 mm Aperture: f/4.4 Shooting Range: 3 m to ∞
ISO Range	Video: 100-6400 Photo: 100-6400
Electronic Shutter Speed	1/8000-2 s
Max Image Size	4000 × 3000
Photo Format	JPEG
Video Format	MP4/MOV (MPEG-4 AVC/H.264, HEVC/H.265)
Still Photography Modes	Single shot: 12 MP
Video Resolution	H.264/H.265 4K: 3840 × 2160@25/30/50fps FHD: 1920 × 1080@25/30/50fps
Digital Zoom	4x
Gimbal	
Stabilization	3-axis (tilt, roll, pan)
Mechanical Range	Tilt: -135° to +100° Roll: -45° to +45° Pan: -27° to +27°
Controllable Range	Tilt: -90° to 35° Pan: -5° to 5°

Max Control Speed (tilt)	100°/s
Angular Vibration Range	±0.007°
Sensing System	
Type	Omnidirectional Vision Systems and Infrared Sensing System
Forward Vision System	Precision Measurement Range: 0.5-20 m Detection Range: 0.5-200 m Effective Sensing Speed: ≤15 m/s FOV: 90° (horizontal), 103° (vertical)
Backward Vision System	Precision Measurement Range: 0.5-16 m Effective Sensing Speed: ≤12 m/s FOV: 90° (horizontal), 103° (vertical)
Lateral Vision System	Precision Measurement Range: 0.5-25 m Effective Sensing Speed: ≤15 m/s FOV: 90° (horizontal), 85° (vertical)
Upward Vision System	Precision Measurement Range: 0.2-10 m Effective Sensing Speed: ≤6 m/s FOV: 100° (front and back), 90° (left and right)
Downward Vision System	Precision Measurement Range: 0.3-18 m Effective Sensing Speed: ≤6 m/s FOV: 130° (front and back), 160° (left and right)
Operating Environment	Forward, Lateral, Upward, Backward: Discernible surfaces, adequate lighting of lux >15 Downward: Non-reflective, discernible surfaces with diffuse reflectivity of >20%, such as walls, trees, people; Adequate lighting of lux >15 Surface with a clear pattern
Transmission	
Video Transmission System	O3+
Live View Quality	Remote Controller: 1080p@30fps/1080p@60fps
Operating Frequency	2.400-2.4835 GHz, 5.725-5.850 GHz
Max Transmission Distance (unobstructed, free of interference)	15 km (FCC), 8 km (CE/SRRC/MIC)
Max Download Speed	SDR: 5.5 MB/s (with RC-N1) 15 MB/s (with DJI RC Pro)
Latency (depending on environment and mobile device)	130 ms (with RC-N1) 120 ms (with DJI RC Pro)
Antennas	4 antennas, 2T4R
Transmitter Power (EIRP)	2.4 GHz: <33 dBm (FCC), <20 dBm (CE/SRRC/MIC) 5.8 GHz: <33 dBm (FCC), <30 dBm (SRRC), <14 dBm (CE)
Intelligent Flight Battery	
Capacity	5000 mAh
Standard Voltage	15.4 V
Max Charging Voltage	17.6 V
Battery Type	LiPo 4S
Energy	77 Wh
Weight	335.5 g
Charging Temperature	5° to 40° C (41° to 104° F)

Battery Charger	
Input	100-240 V AC (47-63 Hz) 2.0 A
Output	USB-C: 5.0 V = 5.0 A/9.0 V = 5.0 A/12.0 V = 5.0 A/15.0 V = 4.3 A/ 20.0 V = 3.25 A/5.0 V~20.0 V = 3.25 A USB-A: 5 V = 2 A
Rated Power	65 W

Charging Hub	
Input	USB-C: 5 V-20 V = 5.0 A max
Output	Battery Port: 12 V - 17.6 V = 5.0 A max
Rated Power	65 W
Charging Type	Charge three Intelligent Flight Batteries in sequence
Charging Temperature	5° to 40° C (41° to 104° F)

Car Charger	
Input	Car Power Port: 12.7 V-16 V = 6.5 A, Voltage: 14 V DC
Output	USB-C: 5.0 V = 5.0 A/9.0 V = 5.0 A/12.0 V = 5.0 A/15.0 V = 4.3A/ 20.0 V = 3.25 A/5.0 V~20.0 V = 3.25 A USB-A: 5 V = 2 A
Rated Power	65 W
Charging Time	Approx. 96 mins
Charging Temperature	5° to 40° C (41° to 104° F)

Storage	
Supported SD Cards	SDXC, UHS-I Speed Grade 3 rating microSD card
Recommended microSD Cards	<p>Lexar 1066x 64GB V30 A2 microSDXC Lexar 1066x 128GB V30 A2 microSDXC Lexar 1066x 256GB V30 A2 microSDXC Lexar 1066x 512GB V30 A2 microSDXC SanDisk High Endurance 64GB V30 microSDXC SanDisk High Endurance 128GB V30 microSDXC SanDisk High Endurance 256GB V30 microSDXC Kingston Canvas Go! Plus 64GB V30 A2 microSDXC Kingston Canvas Go! Plus 128GB V30 A2 microSDXC Kingston Canvas Go! Plus 256GB V30 A2 microSDXC Kingston Canvas Go! Plus 512GB V30 A2 microSDXC Samsung EVO Plus 512GB V30 A2 microSDXC Samsung PRO Plus 256GB V30 A2 microSDXC Samsung PRO Plus 512GB V30 A2 microSDXC</p> <p>microSD Cards are not capable of recording Apple ProRes 422 HQ codec.</p>

SSD	<p>Capacity: 1TB Max Read Speed: 700MB/s* Max Write Speed: 471MB/s*</p> <p>* Max read or write speed of the aircraft. The speed may vary when connected to a computer or other device.</p>
-----	--

DJI RC-N1 Remote Controller

Transmission System	When used with different aircraft hardware configurations, DJI RC-N1 Remote Controllers will automatically select the corresponding firmware version for updating and support the following transmission technologies enabled by the hardware performance of the linked aircraft models: a. DJI Mini 2/ DJI Mavic Air 2: O2 b. DJI Air 2S: O3 c. DJI Mavic 3: O3+
Operating Time	6 hours (without charging the mobile device) 4 hours (with charging the mobile device)
Supported USB Port Types	Lightning, Micro USB, USB-C
Max Supported Mobile Device Size(H×W×T)	180 mm × 86 mm × 10 mm
Operating Temperature	0° to 40° C (32° to 104° F)
Transmitter Power (EIRP)	2.4 GHz: ≤26 dBm (FCC), ≤20 dBm (CE/SRRC/MIC) 5.8 GHz: ≤26 dBm (FCC/SRRC), ≤14 dBm (CE)

Firmware Update

Use DJI Fly or DJI Assistant 2 (Consumer Drones Series) to update the aircraft firmware.

Using DJI Fly

When you connect the aircraft or remote controller to DJI Fly, you will be notified if a new firmware update is available. To start updating, connect your remote controller or mobile device to the internet and follow the onscreen instructions. Note that you cannot update the firmware if the remote controller is not linked to the aircraft. Internet is required.

Using DJI Assistant 2 (Consumer Drones Series)

Update the aircraft and remote controller firmware separately using DJI Assistant 2 (Consumer Drones Series).

Follow the instructions below to update the aircraft firmware through DJI Assistant 2 (Consumer Drones Serie

1. Launch DJI Assistant 2 (Consumer Drones Series) and log in with your DJI account.
2. Power on the aircraft and connect the aircraft to a computer via the USB-C port.
3. Select DJI Mavic 3 and click on Firmware Updates on the left panel.
4. Select the firmware version that you wish to update to.
5. Wait for the firmware to download. The firmware update will start automatically.
6. The aircraft will reboot automatically after the firmware update is complete.

Follow the instructions below to update the remote controller firmware through DJI Assistant 2 (Consumer Drones Series):

1. Launch DJI Assistant 2 (Consumer Drones Series) and log in with your DJI account.
2. Power on the remote controller and connect to a computer via the USB-C port using a Micro USB cable.
3. Select DJI Mavic 3 Remote Controller and click on Firmware Updates on the left panel.
4. Select the firmware version that you wish to update to.
5. Wait for the firmware to download. The firmware update will start automatically.
6. Wait for the firmware update to be completed.



- Make sure follow all the steps to update firmware. Otherwise, the update may fail.
 - The firmware update will take approximately 10 minutes. It is normal that the gimbal goes limp, aircraft status indicators blink, and the aircraft reboots. Wait patiently until the update is complete.
 - Make sure the computer has access to the internet.
 - Before performing an update, make sure the Intelligent Flight Battery is at least 40% charged and the remote controller is at least 30% charged.
 - Do not disconnect the aircraft from the computer during an update.
 - DO NOT use Hardware and Software that is not specified by DJI. Refer to the Mavic 3 Release Notes for more firmware update information for Traceability.
-

Troubleshooting Procedures

1. Why can the battery not be used before the first flight?
The battery must be activated by charging before using it for the first time.
2. How to solve the gimbal drift issue during flight?
Calibrate IMU and compass in DJI Fly. If the problem persists, contact DJI Support.
3. No function
Check if the Intelligent Flight battery and the remote controller are activated by charging. If the problems persist, contact DJI support.
4. Power-on and start-up problems
Check if the battery has power. If yes, contact DJI support if it cannot be started normally.
5. SW update issues
Follow the instructions in the user manual to update the firmware. If the firmware update fails, restart all the devices and try again. If the problem persists, contact DJI support.
6. Procedures to reset to factory default or last known working configuration
Use the DJI Fly app to reset to factory default.
7. Shutdown and power-off problems
Contact DJI support.
8. How to detect careless handling or storage in unsafe conditions
Contact DJI support.

Risk and Warnings

When the aircraft detects a risk after powering on, there will be a warning prompt on DJI Fly. Pay attention to the list of situations below.

1. If the location is not suitable for takeoff.
2. If an obstacle is detected during flight.
3. If the location is not suitable for landing.
4. If the compass and IMU experience interference and need to be calibrated.
5. Follow the on-screen instructions when prompted.

Disposal



Observe the local regulations related to electronic devices when disposing of the aircraft and remote controller.

Battery Disposal

Dispose of the batteries in specific recycling containers only after a complete discharge. DO NOT dispose of the batteries in regular trash containers. Strictly follow the local regulations regarding the disposal and recycling of batteries.

Dispose of a battery immediately if it cannot be powered on after over-discharging.

If the power on/off button on the Intelligent Flight Battery is disabled and the battery cannot be fully discharged, contact a professional battery disposal/recycling agency for further assistance.

C1 Certification

Mavic 3 V2.0 is comply with C1 certification, there are some requirements and restrictions when using Mavic 3 V2.0 in European Economic Area (EEA, i.e. EU plus Norway, Iceland and Liechtenstein).

UAS Class	C1
Sound Power Level	83 dB
Maximum Propeller Speed	7500 RPM

MTOM Statement

The MTOM of Mavic 3 V2.0 (Model L2AA), including the SD card, is 895 g to comply with C1 requirements.

Users must follow the instructions below to comply with the MTOM C1 requirements. Otherwise, the aircraft cannot be used as a C1 UAV:

1. DO NOT add any payload to the aircraft, such as the propeller guards, etc.
2. DO NOT use any non-qualified replacement parts, such as intelligent flight batteries or propellers, etc.
3. DO NOT retrofit the aircraft.



- The prompt "Low Battery RTH" will not appear in case of a horizontal distance between the pilot and aircraft is lower than 5 m.
- FocusTrack will exit automatically if the horizontal distance between the subject and the aircraft is further than 50 m (only available when using FocusTrack in the EU).
- The auxiliary LED is set to auto when used in the EU and cannot be changed. The aircraft Front Arm LEDs are always on when used in the EU and cannot be changed.

Direct Remote ID

1. Transport Method: Wi-Fi Beacon
2. Method of uploading the UAS Operator Registration Number to the aircraft: Enter DJI Fly > Safety > UAS Remote Identification, and then upload UAS Operator Registration Number.

List of Items, including qualified accessories

1. DJI Mavic 3 V2.0 Low-Noise Propellers (Model: 9453F, 8.5g)
2. DJI Mavic 3 V2.0 ND Filters Set (ND 4/8/16/32/64/128/256/512) (2.3 g)
3. DJI Mavic 3 V2.0 Intelligent Flight Battery (Model: BWX260-5000-15.4, 335.5 g)

List of Spare and Replacement Parts

1. DJI Mavic 3 V2.0 Low-Noise Propellers (Model: 9453F)
2. DJI Mavic 3 V2.0 Intelligent Flight Battery (Model: BWX260-5000-15.4)

Remote Controller Warnings

The remote controller indicator will glow red after disconnecting from the aircraft for more than two seconds.

DJI Fly will prompt a warning after disconnecting from the aircraft for more than 4.5 seconds.

The remote controller will beep and power off automatically after disconnecting from the aircraft or without operation for a long time.



- Avoid interference between the remote controller and other wireless equipment. Make sure to turn off the Wi-Fi on nearby mobile devices. Land the aircraft as soon as possible if there is interference.
 - DO NOT operate the aircraft if lighting conditions are too bright or dark when using a mobile phone to monitor the flight. Users are responsible for correctly adjusting the display brightness when using the monitor in direct sunlight during flight operation.
 - Release the control sticks or press the flight pause button if an unexpected operation occurs.
-

GEO Awareness

GEO Awareness contains the features listed below.

UGZ (Unmanned Geographical Zone) Data update: user can update the fly safe data through GPS by using the data update feature and store the data in the aircraft.

GEO Awareness Map Drawing: after the latest UZG data is updated, a flight map with a restricted zone will be displayed in the DJI Fly app. Name, effective time, height limit, etc., can be viewed by tapping the area.

GEO Awareness Pre-Warning: the app will prompt the user with warning information when the aircraft is near or in a restricted area, the horizontal distance is less than 160 m, or the vertical distance is less than 40 m from the zone to remind the user to fly with caution.

AGL (Above Ground Level) Statement

The vertical part of "Geo-awareness" may use the AMSL altitude or the AGL height. The choice between these two references is specified individually for each UGZ. Neither AMSL altitude nor the AGL height is supported by DJI Mavic 3 V2.0. The height H appears in the DJI Fly app camera view, which is the height from the aircraft takeoff point to the aircraft. The height above the takeoff point may be used as an approximation but may differ more or less from the given altitude/height for a specific UGZ. The remote pilot remains responsible for not breaching the vertical limits of the UGZ.

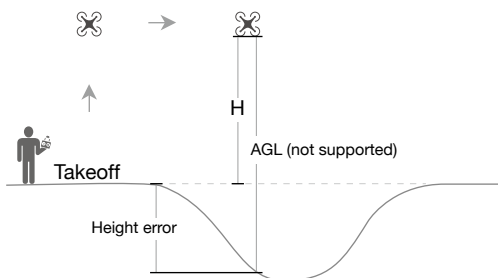

Restricted Zones

Appear red in the DJI app. Users will be prompted with a warning, and flight is prevented. UA cannot fly or takeoff in these zones. Restricted Zones may be unlocked, to unlock contact flysafe@dji.com or go to Unlock A Zone at dji.com/flysafe.

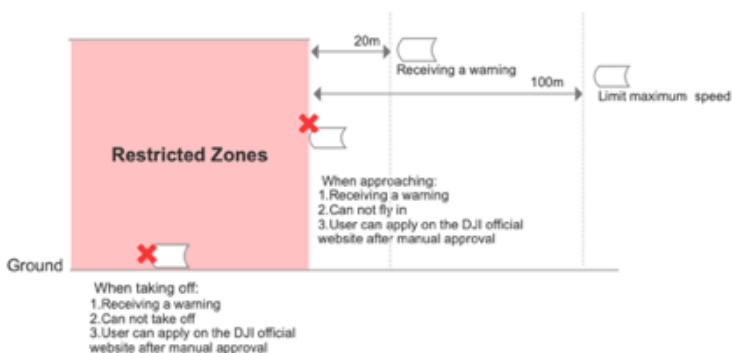

Authorization Zones

Appear blue in the DJI app. Users will be prompted with a warning, and flight is limited by default. UA cannot fly or takeoff in these zones unless authorized. Authorization Zones may be unlocked by authorized users using a DJI verified account.

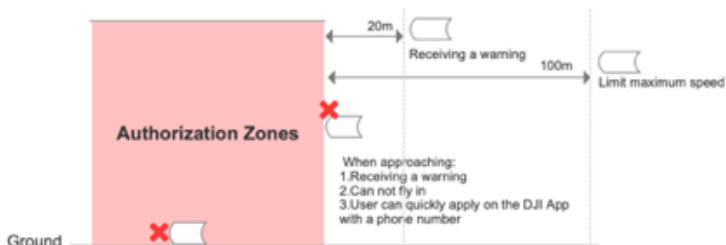

Altitude Zones

Altitude zones are zones with a limited altitude and appear in gray on the map. When approaching, users receive warnings in the DJI app.

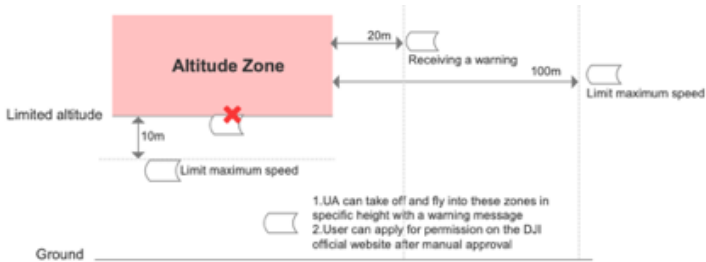

Enhanced Warning Zones

A warning message will prompt users when the drone reaches the edge of the zone.

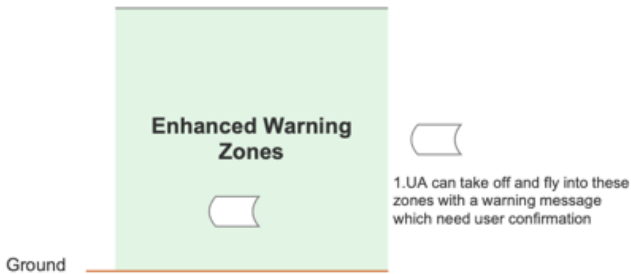

Warning Zones

A warning message will prompt users when the drone reaches the edge of the zone.



 When the aircraft and DJI Fly app cannot obtain a GPS signal, the GEO awareness function will be inoperative. Interference of the aircraft antenna or disabling the GPS authorization in DJI Fly will cause the GPS signal fails to be obtained.

Original Instructions

This manual is provided by SZ DJI Technology, Inc., and the content is subject to change.

Address: 14th Floor, West Wing,

Skyworth Semiconductor Design Building, No 18 Gaoxin South 4th Ave, Nanshan District, Shenzhen, China, 518057.

FAR Remote ID Compliance Information

The aircraft complies with the requirements of 14 CFR Part 89:

- The aircraft automatically broadcasts Remote ID messages from takeoff to shut down. An external device such as a cell phone or tablet is required to be connected as a location source to DJI mobile devices without an integrated GNSS system [1], and must run the DJI flight control app such as DJI Fly in the foreground and always allow the DJI flight control app to obtain its accurate location information. The connected external device must minimally be one of the following:

- 1) FCC Certified personal wireless device that uses GPS with SBAS (WAAS) for location services; or
- 2) FCC Certified personal wireless device with integrated GNSS.

Also, the external device must be operated in a way that does not interfere with the location reported and its correlation to the operator location.

- The aircraft automatically initiates a pre-flight self-test (PFST) of the Remote ID system before takeoff and cannot take off if it does not pass the PFST [2]. The results of the PFST of the Remote ID system can be viewed in either a DJI flight control app such as DJI Fly or DJI goggles.
- The aircraft monitors the Remote ID system functionality from pre-flight to shut down. If the Remote ID system malfunctions or has a failure, an alarm will be displayed in either a DJI flight control app such as DJI Fly or DJI goggles.

Footnotes

1. DJI mobile devices without an integrated GNSS system such as DJI RC-N1, DJI FPV Goggles V2, and DJI Goggles 2.
2. The pass criterion for PFST is that the hardware and software of the Remote ID required-data source and transmitter radio in the Remote ID system are functioning properly.

After-Sales Information

Visit <https://www.dji.com/support> to learn more about after-sales service policies, repair services, and support.

DJI Support
<http://www.dji.com/support>

This content is subject to change.

Download the latest version from
<http://www.dji.com/mavic-3>

If you have any questions about this document, please contact
DJI by sending a message to **DocSupport@dji.com**.

DJI is a trademark of DJI.

Copyright © 2022 DJI All Rights Reserved.