

# SAMSUNG

# User guide

## Gaming Monitor

S27FG50\*E S27DG60\*S S27FG70\* S27FG81\*S S27FG90\*X  
S32FG50\*E S27DG61\*S S37FG75\* S32FG81\*S  
S27FG50\*S S27FG60\*S S40FG75\*  
S27FG60\*E

The colour and the appearance may differ depending on the product, and the content in the manual is subject to change without prior notice to improve the performance.

The contents of this manual are subject to change without notice to improve quality.

© Samsung

Samsung owns the copyright for this manual.

Use or reproduction of this manual in parts or entirety without the authorization of Samsung is prohibited.

Trademarks other than that of Samsung are owned by their respective owners.

---

# Table of contents

## Before Using the Product

Safety Precautions	4
Electricity and Safety	4
Installation	5
Operation	6
Cleaning	8
Correct posture to use the product	8

## Product Overview

Function Key Guide	10
Ports	11

## Installation

Attaching the Stand	12
Precautions for moving the product	15
Checking the space around the product	16
Adjusting the Product Tilt and Height	17
Rotating the Product	21
Wall Mount Kit Specifications (VESA)	22
Installing the Software	23
Easy Setting Box	23
Driver Installation	23

## Connections

Read below before connecting the product.	24
Connecting and Using a PC	24
Connection Using the HDMI Cable	24
Connection Using an DP Cable	25
Connecting to headphones or earphones	25
Connecting the Product to a PC as a USB HUB	25
Connecting the Power	26
Tidying Up the Cables	27
Setting Optimum Resolution	28

## Using the 3D Monitor

To view 3D content:	29
Read before using the 3D monitor	29
Installing the 3D monitor	30
Launching Odyssey 3D Hub	31
Playing a game	31
Converting 2D to 3D	31
Recommended computer specifications	32

## Menu

Game	33
Picture	36
PIP(PIP/PBP)	41
OnScreen Display	41
System	41
Support	45

---

# Table of contents

## Troubleshooting

---

Requirements Before Contacting Samsung Customer Service Centre	46
Check the following.	46
Installation issue (PC mode)	46
Screen issue	47
Sound issue	48
Source device issue	48
Issues related to the stereo camera	48
Other issue	48

## Specifications

---

General	49
Licences & Other Information	52
Standard Signal Mode Table	53
List of graphic cards supporting HDR10	58

## Appendix

---

Responsibility for the Pay Service (Cost to Customers)	59
FreeSync (for AMD graphics card)	60
Adaptive-Sync (for NVIDIA graphics card)	61

# Before Using the Product

## Safety Precautions

### Warning

A serious or fatal injury may result if instructions are not followed.







### Caution

Personal injury or damage to properties may result if instructions are not followed.

#### CAUTION

#### RISK OF ELECTRIC SHOCK. DO NOT OPEN.

CAUTION: TO REDUCE THE RISK OF ELECTRIC SHOCK, DO NOT REMOVE COVER (OR BACK). THERE ARE NO USER SERVICEABLE PARTS INSIDE. REFER ALL SERVICING TO QUALIFIED PERSONNEL.

	<p>This symbol indicates that high voltage is present inside. It is dangerous to make any kind of contact with any internal part of this product.</p>		<p>AC voltage: Rated voltage marked with this symbol is AC voltage.</p>
	<p>This symbol indicates that this product has included important literature concerning operation and maintenance.</p>		<p>DC voltage: Rated voltage marked with this symbol is DC voltage.</p>
	<p>Class II product: This symbol indicates that a safety connection to electrical earth (ground) is not required. If this symbol is not present on a product with a mains lead, the product MUST have a reliable connection to protective earth (ground).</p>		<p>Caution. Consult instructions for use: This symbol instructs the user to consult the user manual for further safety related information.</p>

## Electricity and Safety

### Warning

- Do not use a damaged power cord or plug, or a loose power socket.
- Do not use multiple products with a single power socket.
- Do not handle the power cord with a wet body part.
- Insert the power plug all the way in so it is not loose.
- Connect the power plug to a grounded power socket (type 1 insulated devices only).
- Do not bend or pull the power cord with force. Be careful not to leave the power cord under a heavy object.
- Do not place the power cord or product near heat sources.
- Clean any dust around the pins of the power plug or the power socket with a dry cloth.

### Caution

- Do not disconnect the power cord while the product is being used.
- Only use the power cord provided with your product by Samsung. Do not use the power cord with other products.
- Keep the power socket where the power cord is connected unobstructed.
  - The power cord must be disconnected to cut off power to the product when an issue occurs.
- Hold the plug when disconnecting the power cord from the power socket.

---

## Installation

### Warning

- DO NOT PLACE CANDLES, INSECT REPELLANTS OR CIGARETTES ON TOP OF THE PRODUCT. DO NOT INSTALL THE PRODUCT NEAR HEAT SOURCES.
- Do not install the product in poorly ventilated spaces such as a bookcase or closet.
- Install the product at least 10cm away from the wall to allow ventilation.
- Discard the plastic packaging that the product is packaged in, immediately after unpacking.
  - Plastic packaging material can cause suffocation if it is handled improperly.
- Do not install the product on an unstable or vibrating surface (insecure shelf, sloped surface, etc.)
  - The product may fall and become damaged and/or cause an injury.
  - Using the product in an area with excess vibration may damage the product or cause a fire.
- Do not install the product in a vehicle or a place exposed to dust, moisture (water drips, etc.), oil, or smoke.
- Do not expose the product to direct sunlight, heat, or a hot object such as a stove.
  - The product lifespan may be reduced or a fire may result.
- Edible oil, such as soybean oil, can damage or deform the product. Do not install the product in a kitchen or near a kitchen counter.

---

### Caution

- Do not drop the product while moving.
- Do not set down the product on its front.
- When installing the product on a cabinet or shelf, make sure that the bottom edge of the front of the product is not protruding.
  - The product may fall and become damaged and/or cause an injury.
  - Install the product only on cabinets or shelves of the right size.
- Set down the product gently.
  - Product failure or personal injury may result.
- Installing the product in an unusual place (a place exposed to a lot of fine dust, chemical substances, extreme temperatures or a significant presence of moisture, or a place where the product will operate continuously for an extended period of time) may seriously affect its performance.
  - Be sure to consult Samsung Customer Service Centre if you want to install the product at such a place.
- Before assembling the product, place the product down on a flat and stable surface so that the screen is facing downwards.
  - The product is curved. Placing pressure on the product when on a flat surface may damage the product. When the product is on the ground facing up or down, do not put pressure on it.
- In the same series, the colour can vary depending on the size.

---

## Operation

### Warning

- There is a high voltage inside the product. Never disassemble, repair or modify the product yourself.
    - Contact Samsung Customer Service Centre for repairs.
  - To move the product, first disconnect all the cables from it, including the power cord.
  - If the product generates abnormal sounds, a burning smell or smoke, disconnect the power cord immediately and contact Samsung Customer Service Centre.
  - Do not hang on to or climb on the product.
    - The product may tip over or fall, causing injury or death.
  - If the product is dropped or the outer case is damaged, turn off the power and disconnect the power cord. Then contact Samsung Customer Service Centre.
    - Continued use can result in a fire or electric shock.
  - Do not put heavy objects, toys or snacks on top of the product.
    - Hanging on to the product to get a toy or snack may cause heavy objects to fall or the product to tip over, resulting in injury or death.
  - During a lightning or thunderstorm, power off the product and remove the power cord.
  - Do not drop objects on the product or apply impact.
  - Do not move the product by pulling the power cord or any cable.
  - If a gas leakage is found, do not touch the product or power plug. Also, ventilate the area immediately.
- Do not lift or move the product by pulling the power cord or any cable.
  - Do not use or keep combustible spray or an inflammable substance near the product.
  - Ensure the vents are not blocked by tablecloths or curtains.
    - An increased internal temperature may cause a fire.
  - Do not insert metallic objects (chopsticks, coins, hairpins, etc) or objects that burn easily (paper, matches, etc) into the product (via the vent or input/output ports, etc).
    - Be sure to power off the product and disconnect the power cord when water or other foreign substances have entered the product. Then contact Samsung Customer Service Centre.
  - Do not place objects containing liquid (vases, pots, bottles, etc) or metallic objects on top of the product.
    - Be sure to power off the product and disconnect the power cord when water or other foreign substances have entered the product. Then contact Samsung Customer Service Centre.
  - Do not use liquid fumigators containing chemicals, such as mosquito repellent or air freshener, around the product.
    - If steam comes in contact with the product surface or enters the product, it may cause stains or malfunction.

---

## Caution

- Leaving the screen fixed on a stationary image for an extended period of time may cause afterimage burn-in or defective pixels.
  - Set the screen to power-saving mode or moving-picture screen saver when not using the product for an extended period of time.
- Disconnect the power cord from the power socket if you do not plan on using the product for an extended period of time (vacation, etc).
  - Dust accumulation combined with heat can cause a fire, electric shock or electric leakage.
- Use the product at the recommended resolution and frequency.
  - Your eyesight may deteriorate.
- Do not put AC/DC adapters together.
- Remove the plastic bag from the AC/DC adapter before you use it.
- Do not let water enter the AC/DC adapter device or get the device wet.
  - An electric shock or fire may result.
  - Avoid using the product outdoors where it can be exposed to rain or snow.
  - Be careful not to get the AC/DC adapter wet when you wash the floor.
- Do not put the AC/DC adapter near to any heating apparatus.
  - Otherwise, a fire may result.
- Keep the AC/DC adapter in a well-ventilated area.
- If you place the AC/DC power adapter hanging with the cord input facing upwards, water or other foreign substances could enter the Adapter and cause the Adapter to malfunction.  
Make sure to rest the AC/DC power adapter flat on a table or the floor.

- 
- Do not hold the product upside-down or move it by holding the stand.
    - The product may fall and become damaged or cause an injury.
  - Looking at the screen too close for an extended period of time can deteriorate your eyesight.
  - Do not use humidifiers or stoves around the product.
  - Take a break for at least 5 minutes after using the product for 1 hour.
  - Do not touch the screen when the product has been turned on for an extended period of time as it will become hot.
  - Exercise caution when storing the remote control batteries and small accessories, so they are not swallowed.
    - If swallowed, consult a physician immediately.
  - Exercise caution when adjusting the product angle.
    - Parts of the human body may become caught and could be injured.
    - Tilting the product at an excessive angle may cause the product to fall and an injury may result.
  - Do not place heavy objects on the product.
    - Product failure or personal injury may result.
  - When using headphones or earphones, do not turn the volume too high.
    - Having the sound too loud may damage your hearing.

---

## Cleaning

High-glossy models can develop white stains on the surface if an ultrasonic wave humidifier is used nearby.

— Contact your nearest Samsung Customer Service Centre if you want to clean the inside of the product (Service fee will be charged.)

Do not press the monitor screen. There is a risk of damaging it.

— Exercise care when cleaning as the panel and exterior of advanced LCDs are easily scratched.

— The product screen is vulnerable to fingerprints, as there is no protective film on it. (S27FG90\*X models only)

Take the following steps when cleaning.

- 1 Power off the product and PC.
- 2 Disconnect the power cord from the product.
  - When removing the power cord, hold the plug. Never hold the plug with a wet body part. Otherwise, an electric shock may result.
- 3 Wipe the product with a clean, soft and dry cloth.

Wet a soft cloth in water, wring it out well, and then use the cloth to wipe the exterior of the product clean.

  - Do not apply a cleaning agent that contains alcohol, solvent, or surfactant to the product.
  - Do not spray water or detergent directly on the product.
- 4 Connect the power cord to the product when cleaning is finished.
- 5 Power on the product and PC.

---



## Correct posture to use the product



Use the product in the correct posture as follows:

- Straighten your back.
- Allow a distance of 45 to 50cm in 2D mode between your eye and the screen, and look slightly downward at the screen.
- Keep your eyes directly in front of the screen.
- Adjust the angle so light does not reflect on the screen.
- Keep your forearms perpendicular to your upper arms and level with the back of your hands.
- Keep your elbows at about a right angle.
- Adjust the height of the product so you can keep your knees bent at 90 degrees or more, your heels attached to the floor, and your arms lower than your heart.
- Do the Eye exercises or blink frequently, then eye fatigue will be relieved.

# Product Overview

- The colour and shape of parts may differ from what is shown. Specifications are subject to change without notice to improve quality.
- You can turn on the product with the  button, and then use the Function Key Guide. Function Key Guide appears when the  button is pressed while the product is On.

S27FG50\*S

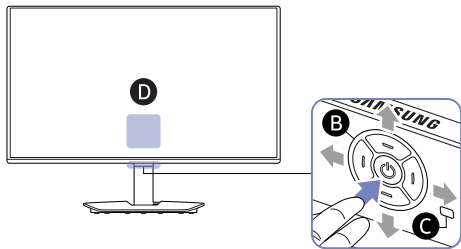

S27FG50\*E / S32FG50\*E

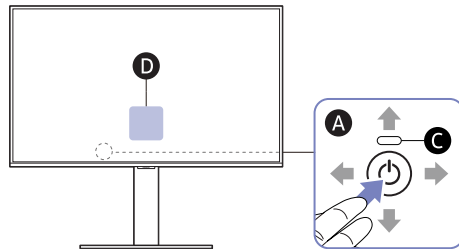

S27DG60\*S / S27DG61\*S / S27FG60\*S / S27FG81\*S / S32FG81\*S

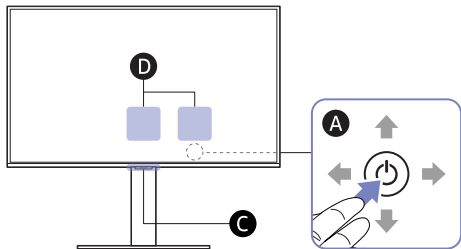



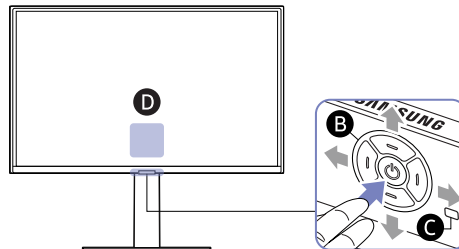



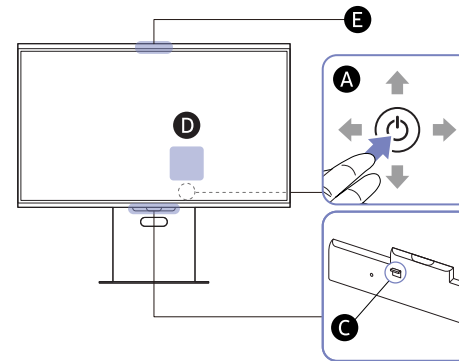



S27FG60\*E / S27FG70\* / S37FG75\* / S40FG75\*



S27FG90\*X



Location	Description
	Use this multi-directional button to turn on the power or navigate menus.
<b>A</b>	<ul style="list-style-type: none"> <li>—  : UP /  : DOWN /  : LEFT /  : RIGHT</li> <li>— The location of the button may vary depending on the model.</li> </ul>
<b>B</b>	<b>5-Way Button:</b> Multi directional button that helps navigate. <ul style="list-style-type: none"> <li>—  : DOWN(FRONT) /  : UP(REAR) /  : LEFT /  : RIGHT</li> </ul>
<b>C</b>	<b>Power LED:</b> This LED is power status indicator. <ul style="list-style-type: none"> <li>— You can select the power LED operation to be enabled or disabled on the menu screen. (  → <b>System</b> → <b>Power LED On</b> )</li> </ul>
<b>D</b>	To use the Function Key Guide, press the  button when the screen is turned on. <ul style="list-style-type: none"> <li>— See the <a href="#">Function Key Guide</a> section.</li> <li>— The location of the Function Key Guide may vary depending on the model.</li> </ul>
<b>E</b>	<b>Camera:</b> Converts 2D images into 3D through the camera lens. <ul style="list-style-type: none"> <li>— For details on using the 3D monitor and camera, refer to the <a href="#">Using the 3D Monitor</a> section.</li> <li>— This function is supported by the S27FG90*X model only.</li> </ul>

---

## Function Key Guide

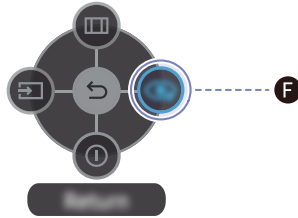

Location	Description
	<b>Custom Key</b> <ul style="list-style-type: none"><li>• Custom Key is used to directly access the function set in <b>Setup Custom Key</b>.</li><li>• <b>Setup Custom Key</b><ul style="list-style-type: none"><li>— Go to  → <b>System</b> → <b>Setup Custom Key</b> and change the custom key.</li></ul></li></ul>
	Changes the input source. A message will appear on the top left corner of the screen if the input source has been changed.
	Displays the main on-screen menu.
	Turns off the product.
	Exits from the menu page.

## Ports

- The names, quantity, and locations of ports may differ, depending on the model.
- The images shown below are for reference only and may differ from the colors and appearances of the actual product components.
- The color and shape of the product may vary depending on the model.

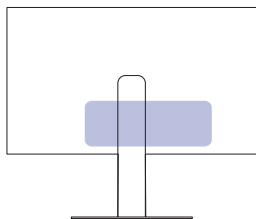

S27FG50\*E / S32FG50\*E

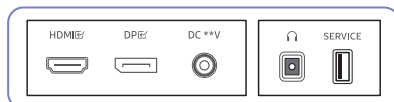

S27FG50\*S

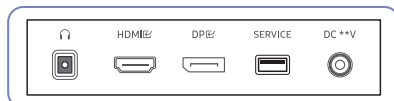

S27FG60\*E

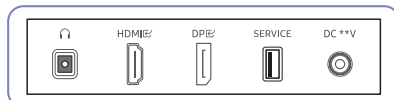

S27DG60\*S / S27DG61\*S

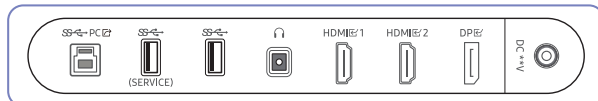

S27FG60\*S / S27FG81\*S / S32FG81\*S

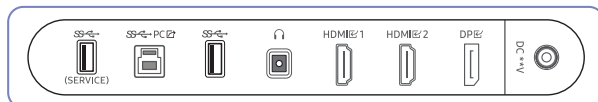

S27FG70\*

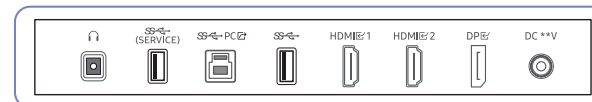

S37FG75\* / S40FG75\*

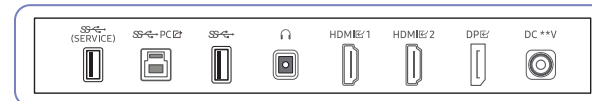

S27FG90\*X

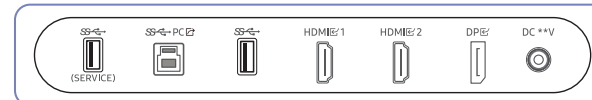

Port	Description
	Connect to an audio output device such as headphones or earphones.
HDMI/E HDMI/E 1 HDMI/E 2	Connects to a source device using an HDMI cable.
DP/E	Connects to a PC using a DP cable.
SERVICE	Used to update the software.
	Connects to a PC using a USB cable. — This port can only connect to a PC.
	Connect to a USB device. Used to update the software.
	Connect to a USB device.
DC **V	Connects to the AC/DC adapter.

# Installation

## Attaching the Stand

- The colour and shape of parts may differ from what is shown. Specifications are subject to change without notice to improve quality.
- Disassembly is the reverse order of assembly.

### Components

S27FG50*E / S32FG50*E	S27FG50*S	S27DG60*S / S27DG61*S / S27FG60*S / S27FG81*S / S32FG81*S
S27FG60*E / S27FG70* / S37FG75* / S40FG75*	S27FG90*X	

### Instructions

#### S27FG50\*E / S32FG50\*E

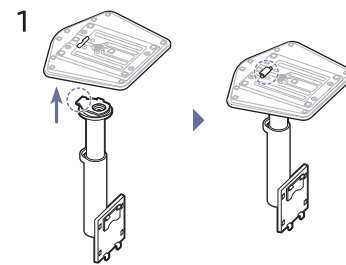

Put the stand base onto the stand neck as the direction shown in the figure. Check that the stand neck is firmly connected.

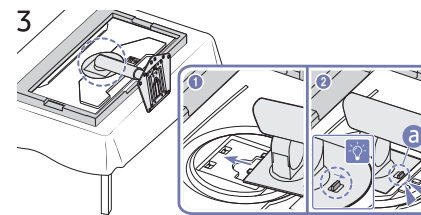

Push the assembled stand into the main body in the direction of the arrow as shown in the figure.

Confirm that the stand is tightly fastened. If **a** has not been fully lowered, lower it while holding it with your hand.

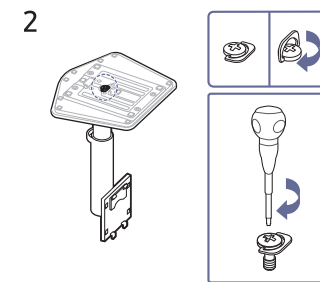

Tightly fasten the connecting screw at the bottom of the stand base.

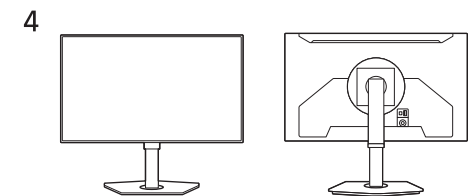

After installing the stand, place the product upright.

### S27FG50\*S

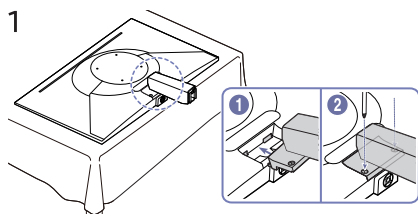

Push the stand neck into the main body in the direction of the arrow as shown in the figure. Tighten the screw at the base of the stand neck.

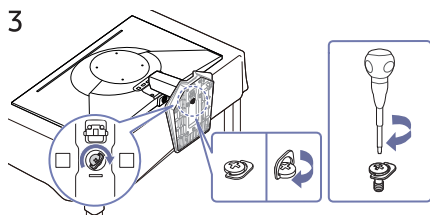

Tightly fasten the connecting screw at the bottom of the stand base.

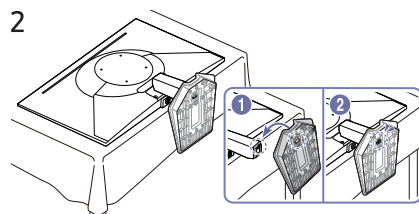

Insert the stand base into the stand neck in the direction as shown in the figure.

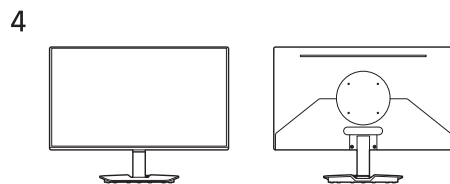

After installing the stand, place the product upright.

### G6 / G7 / G8 Series

1

S27DG60\*S / S27DG61\*S / S27FG60\*S / S27FG81\*S / S32FG81\*S

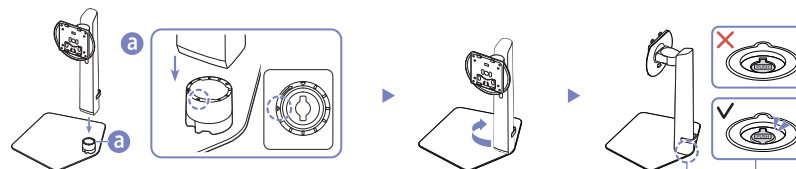

S27FG60\*E / S27FG70\* / S37FG75\* / S40FG75\*

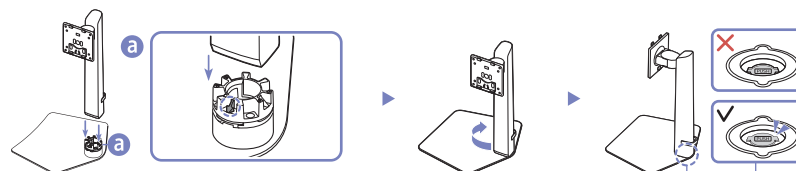

Check the direction of the arrow on the stand base. Align the direction of the arrow on the stand base with the front direction of the stand neck, and then insert the stand neck from top to bottom.

Turn the stand neck clockwise to fasten it to the base. Lift the stand slightly and check that the PUSH button on the bottom of the base protrudes.

2

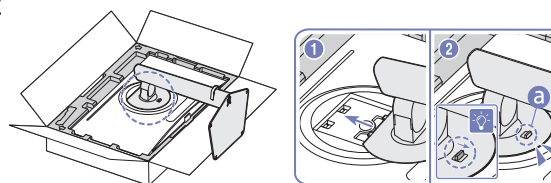

Push the assembled stand into the main body in the direction of the arrow as shown in the figure.

Confirm that the stand is tightly fastened. If ❶ has not been fully lowered, lower it while holding it with your hand.

3

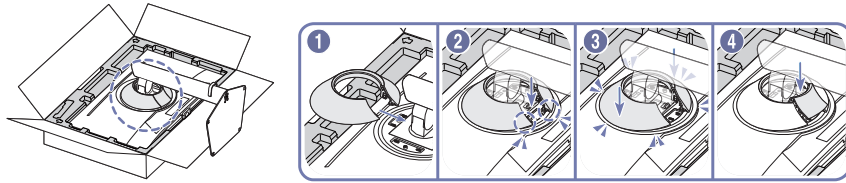

Attach the COVER-REAR TOP to the rear of the monitor, as shown in the figure. (S27FG60\*E / S27FG70\* / S37FG75\* / S40FG75\* models only.)

4

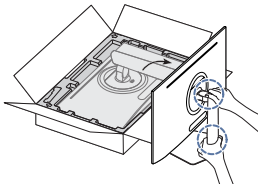

Stand up the monitor as shown in the figure.

5

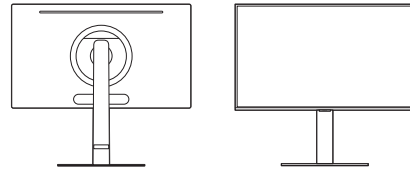

Stand assembly is complete.

### Separating the stand neck from the stand base

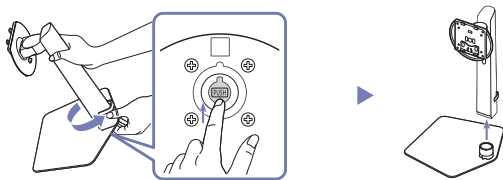

Lift the assembled stand slightly and press the PUSH button on the bottom of the base. While holding down the PUSH button, turn the stand neck anticlockwise to remove it.

S27FG90\*X

1

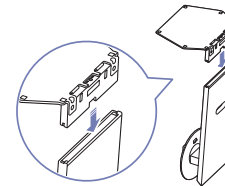

Put the stand base onto the stand neck as the direction shown in the figure. Check that the stand neck is firmly connected.

2

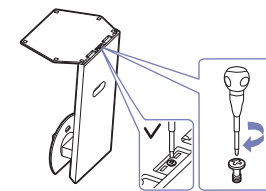

Tightly fasten the connecting screw at the bottom of the stand base.

3

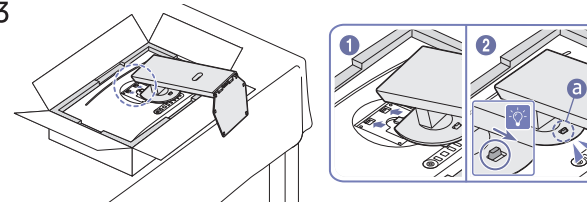

Push the assembled stand into the main body in the direction of the arrow as shown in the figure. Confirm that the stand is tightly fastened. If **a** has not been fully lowered, lower it while holding it with your hand.

4

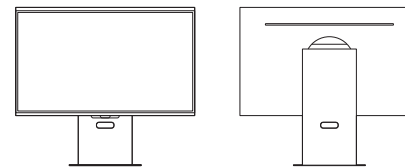

Stand assembly is complete.

## Precautions for moving the product

— The colour and shape of parts may differ from what is shown. Specifications are subject to change without notice to improve quality.

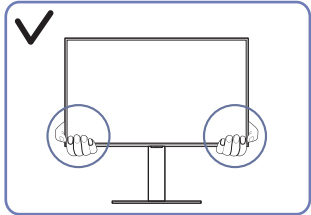

- Hold the lower corners or edges of the product when moving it.

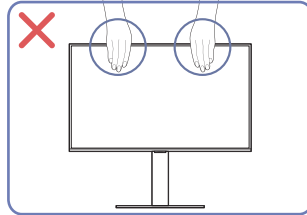

- Do not directly apply pressure on the screen.
- Do not hold the screen when moving the product.

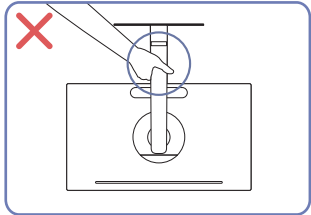

- Do not hold the product upside down only by the stand.

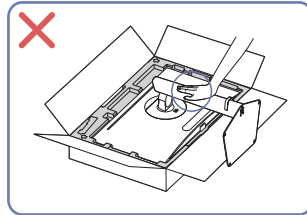

- Do not press down on the product. There is a risk of damaging the product.

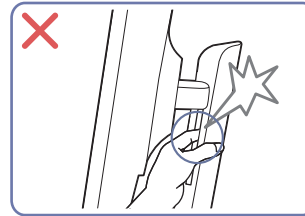

- Be careful not to get any body parts caught.

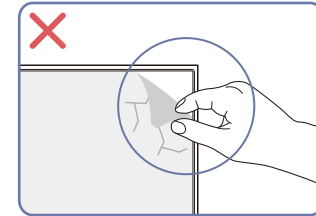

- Do not arbitrarily remove the panel film. If not observed, the warranty service may be restricted.

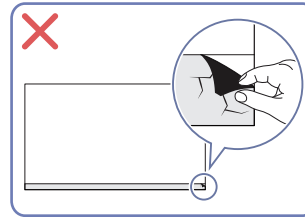

## Checking the space around the product

Make sure to have enough space for ventilation when placing the product. An internal temperature rise may cause fire and damage the product. Maintain enough space around the product as shown in the diagram when installing the product.

— The exterior may differ depending on the product.

### S27FG50\*S

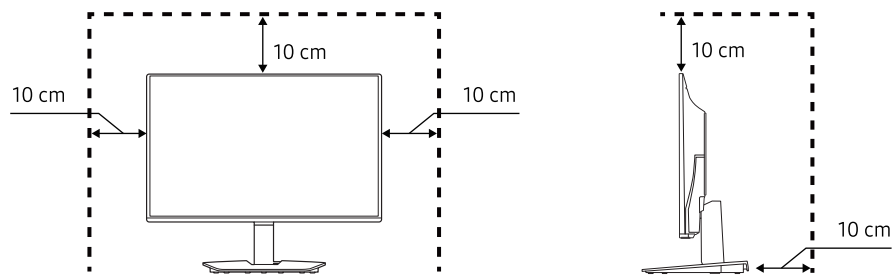

### S27FG50\*E / S32FG50\*E / S27DG60\*S / S27DG61\*S / S27FG60\*S / S27FG60\*E / S27FG70\* / S27FG81\*S / S32FG81\*S

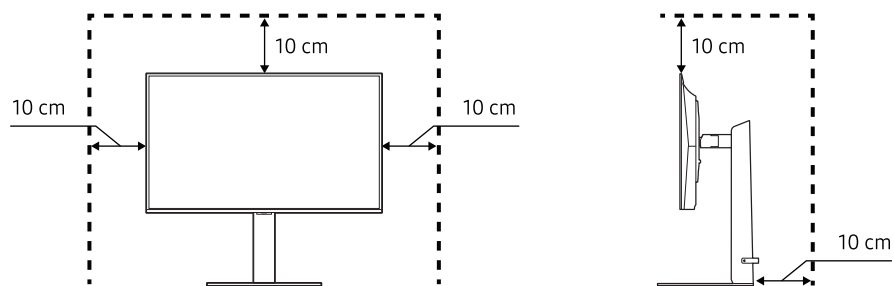

### S37FG75\* / S40FG75\*

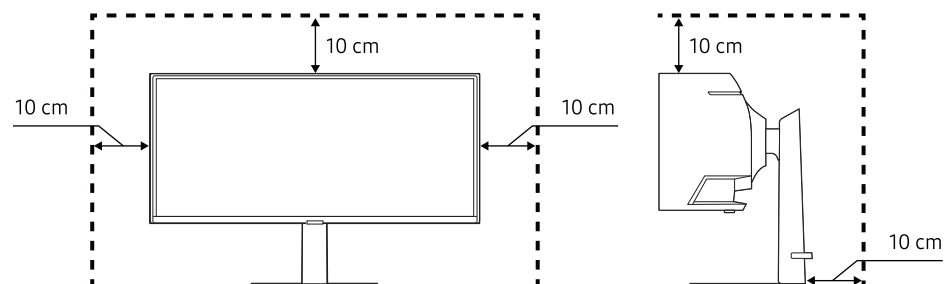

### S27FG90\*X

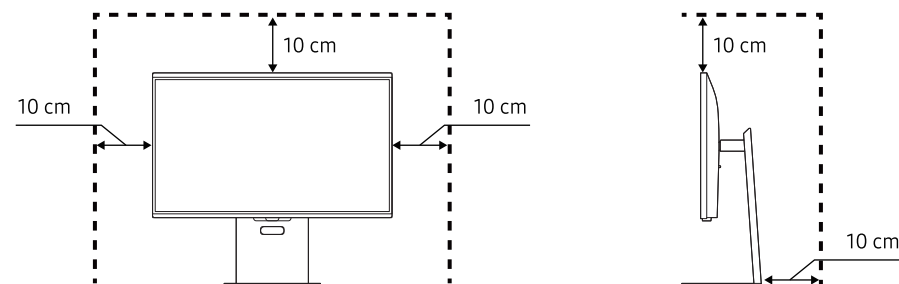

## Adjusting the Product Tilt and Height

— The colour and shape of parts may differ from what is shown. Specifications are subject to change without notice to improve quality.

### S27FG50\*S

-2.0° (±2.0°) ~ 15.0° (±2.0°)

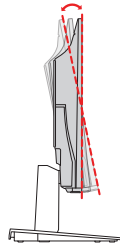

### S27FG50\*E / S32FG50\*E

-45.0° (±3.0°) ~ 45.0° (±3.0°)    -3.0° (±2.0°) ~ 25.0° (±2.0°)    105.0 mm (±5.0 mm)

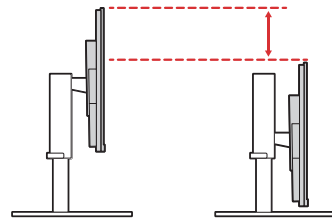
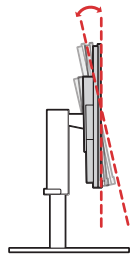
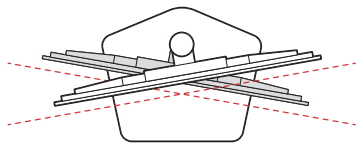

### S27DG60\*S / S27DG61\*S / S27FG60\*S / S27FG60\*E / S27FG70\* / S27FG81\*S / S32FG81\*S

-30.0° (±3.0°) ~ 30.0° (±3.0°)    -2.0° (±2.0°) ~ 25.0° (±2.0°)    120.0 mm (±5.0 mm)

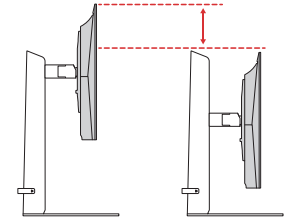
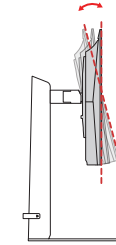
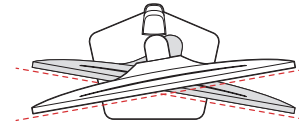

### S37FG75\* / S40FG75\*

-20.0° (±3.0°) ~ 20.0° (±3.0°)    -5.0° (±2.0°) ~ 20.0° (±2.0°)    120.0 mm (±5.0 mm)

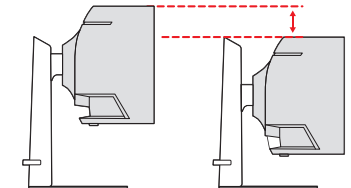
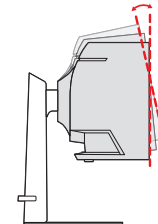
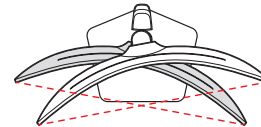

S27FG90\*X

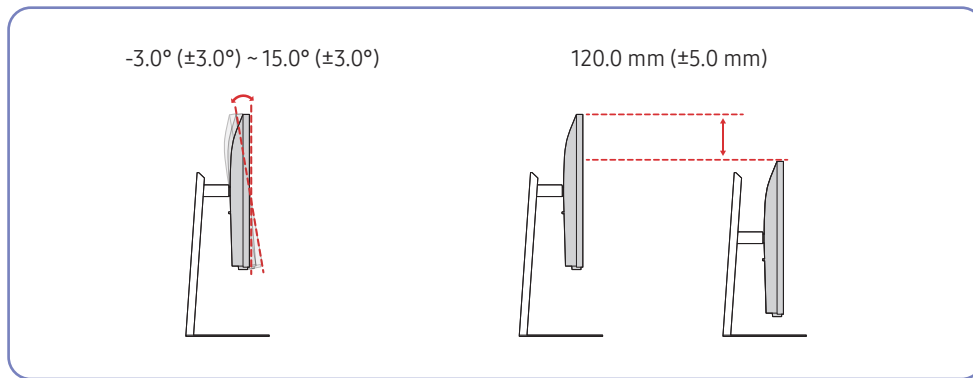

- The product tilt and height can be adjusted.
- Hold the top centre of the product and adjust the height carefully.
- When adjusting the stand height, you may hear a noise. This noise is generated because the ball inside the stand slides when the stand height is adjusted. It is a normal noise and not a product malfunction.
- When adjusting the left/right angles of the product, there may be a slight gap in the connection area of the stand base. This is normal and does not indicate a malfunction of the product.

## Caution

The colour and shape of parts may differ from what is shown. Specifications are subject to change without notice to improve quality.

### S27FG50\*S

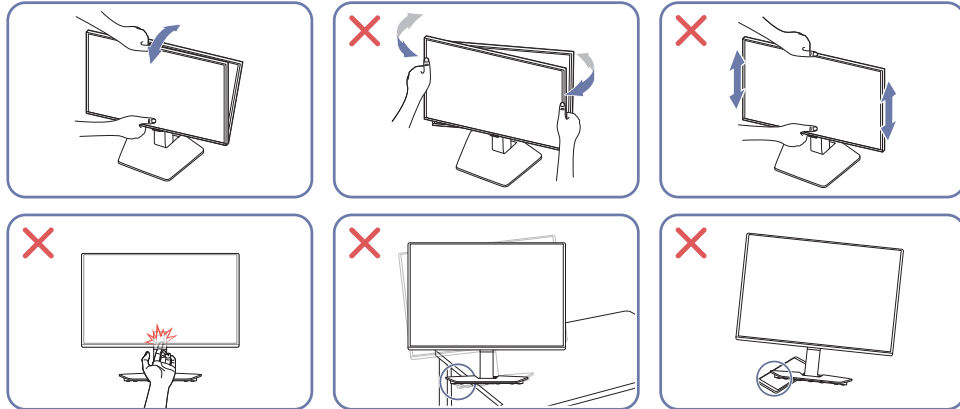

- Do not hold the moving area of the stand when adjusting the tilt or height of the product. It may cause injury.
- When installing the product on a cabinet or shelf, make sure that the bottom edge of the front of the product is not protruding.

### S27FG50\*E / S32FG50\*E / S27DG60\*S / S27DG61\*S / S27FG60\*S / S27FG60\*E / S27FG70\* / S37FG75\* / S40FG75\* / S27FG81\*S / S32FG81\*S

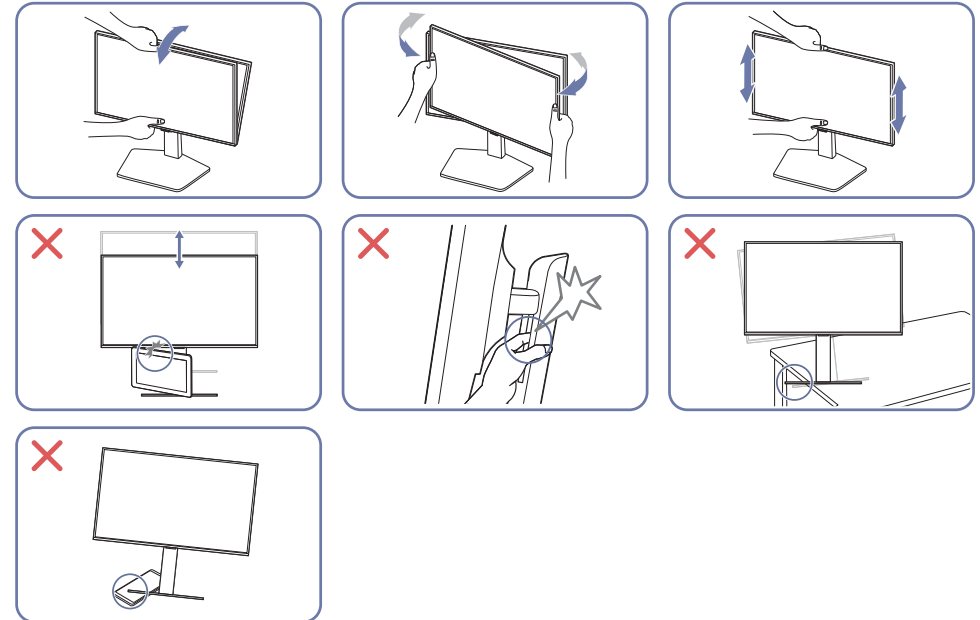

- Grasp the left and right sides of the monitor and adjust the swivel.
- Grasp the centre of the monitor and adjust the height.
- Do not hold the moving area of the stand when adjusting the tilt or height of the product. It may cause injury.
- When installing the product on a cabinet or shelf, make sure that the bottom edge of the front of the product is not protruding.
- Do not put an object around the lower part of the product. The product or object may get damaged when adjusting the product height.

S27FG90\*X

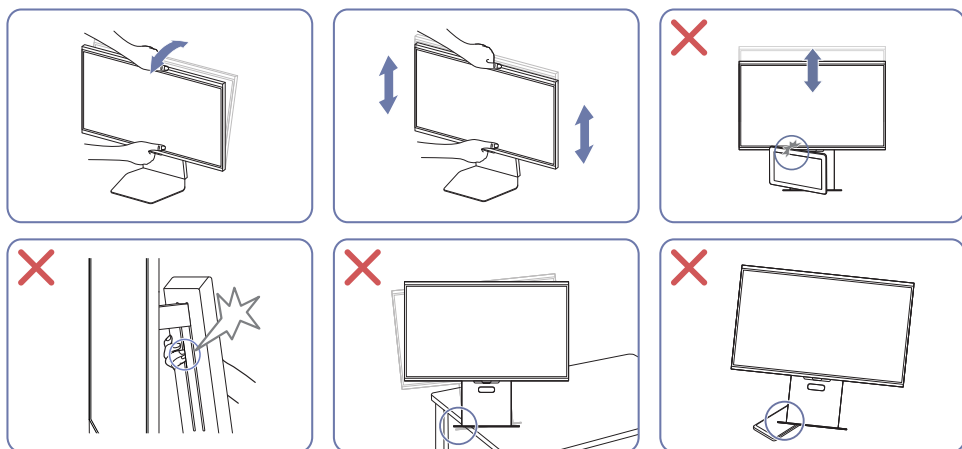

- Grasp the centre of the monitor and adjust the height.
- Do not hold the moving area of the stand when adjusting the tilt or height of the product. It may cause injury.
- When installing the product on a cabinet or shelf, make sure that the bottom edge of the front of the product is not protruding.
- Do not put an object around the lower part of the product. The product or object may get damaged when adjusting the product height.

After adjusting the product tilt and height, if the screen is not level, take the following actions.

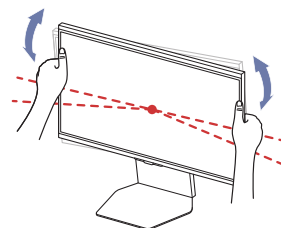

- Hold the bezel at both side edges and adjust the monitor angle until the screen becomes level. (Be careful not to directly hold the LCD display.)

## Rotating the Product

— S27FG50\*S / S37FG75\* / S40FG75\* models are not supported.

— The colour and shape of parts may differ from what is shown. Specifications are subject to change without notice to improve quality.

S27FG50\*E / S32FG50\*E / S27DG60\*S / S27DG61\*S / S27FG60\*S / S27FG60\*E / S27FG70\* / S27FG81\*S / S32FG81\*S

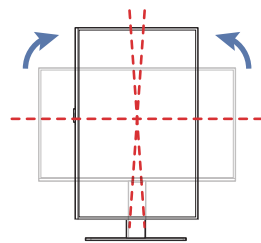
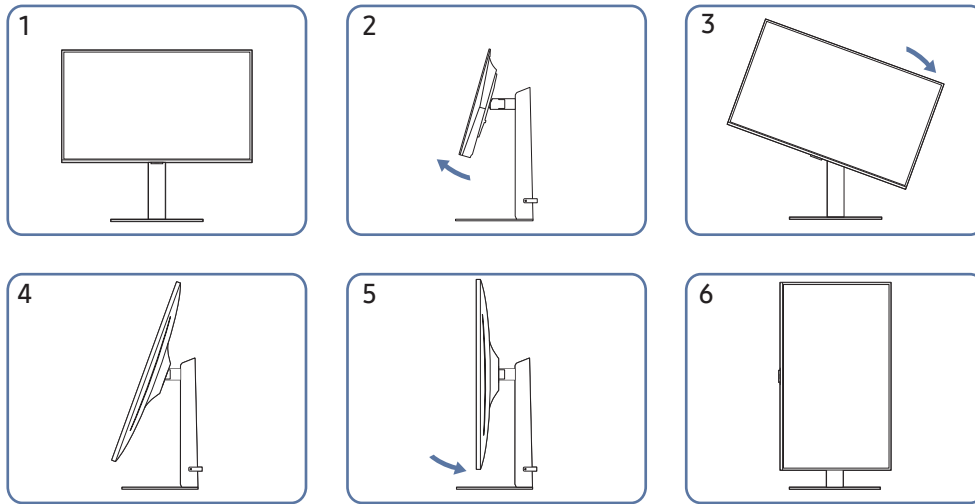

-92.0° (±2.0°) ~ 92.0° (±2.0°)

S27FG90\*X

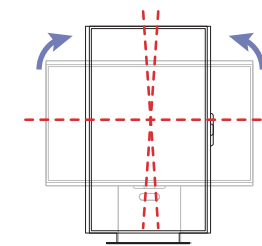
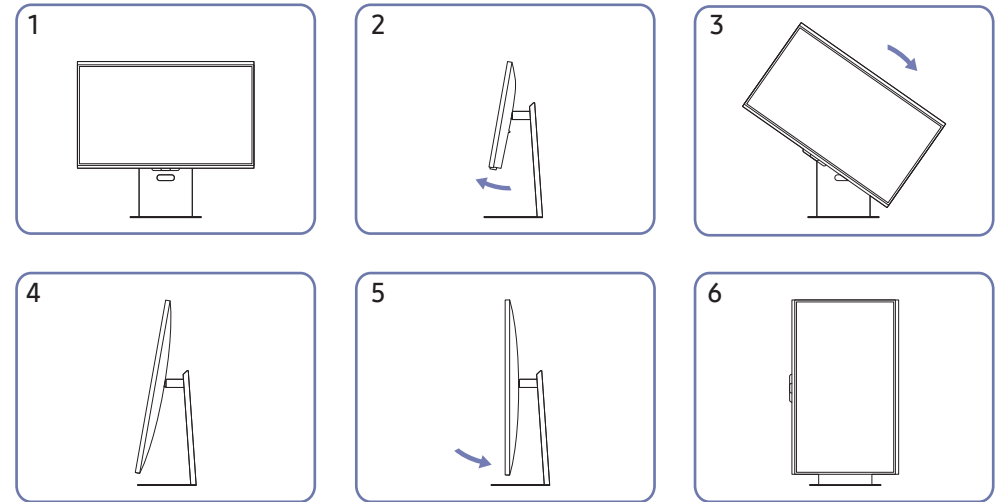

-92.0° (±2.0°) ~ 92.0° (±2.0°)

- Be sure to fully extend the stand before rotating the product.
- If you rotate the product without fully extending the stand, the corner of the product may hit the floor and get damaged.
- When rotating the product, be careful not to damage the product by hitting the object or stand.

## Wall Mount Kit Specifications (VESA)

Install your wall mount on a solid wall perpendicular to the floor. Before attaching the wall mount to surfaces other than plaster board, please contact your nearest dealer for additional information. If you install the product on a slanted wall, it may fall and result in severe personal injury. Samsung wall mount kits contain a detailed installation manual and all parts necessary for assembly are provided.

- Do not use screws that are longer than the standard length or do not comply with the VESA standard screw specifications. Screws that are too long may cause damage to the inside of the product.
- When installing the wall mount other than the specified product, its installation may be difficult.
- For wall mounts that do not comply with the VESA standard screw specifications, the length of the screws may differ depending on the wall mount specifications.
- Do not fasten the screws too firmly. This may damage the product or cause the product to fall, leading to personal injury. Samsung is not liable for these kinds of accidents.
- Samsung is not liable for product damage or personal injury when a non-VESA or non-specified wall mount is used or the consumer fails to follow the product installation instructions.
- Do not mount the product at more than a 15 degree tilt.
- Use the power cable provided with the monitor. (The power input connector on the monitor is 'L' shaped.)
- To install the monitor on a stand, use the supplied stand.  
To use on a personally purchased mounting device (e.g. a monitor arm, stand, or wall mount), install the cables with sufficient slack to allow the monitor to tilt or rotate.  
If a cable is pulled or squeezed, the input connector may be damaged, and any damage resulting from this is not covered under warranty.
- Standard dimensions for wall mount kits are shown in the table follow.

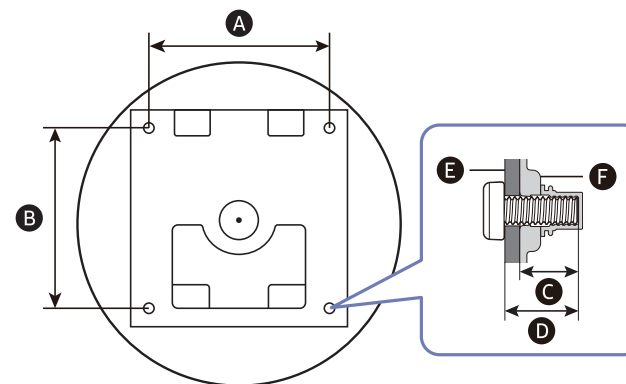

**E** : Wall mount bracket

**F** : Product

Model name	VESA screw hole specs ( <b>A</b> * <b>B</b> ) in millimetres	<b>C</b>	<b>D</b>	Standard Screw	Quantity
S27FG50*S	100.0 x 100.0	8.5 ~ 10.5 mm	<b>C</b> + <b>E</b>	M4	4
S27DG60*S S27DG61*S S27FG60*S S27FG81*S S32FG81*S		7.5 ~ 10.5 mm			
S27FG50*E S32FG50*E S27FG70*		6.5 ~ 8.5 mm			
S37FG75* S40FG75*		6.8 ~ 8.8 mm			
S27FG60*E S27FG90*X		6.5 ~ 8.5 mm			

Do not install your Wall Mount Kit while your product is turned on. It may result in personal injury due to electric shock.

---

## Installing the Software

### Easy Setting Box



Easy Setting Box enables users to use the product by partitioning multiple sections.

To install the latest version of Easy Setting Box, download it from the Samsung website.

(<http://www.samsung.com>)

- The software may not work properly if you do not restart the PC after the installation.
- The Easy Setting Box icon may not appear depending on the PC system and the product specifications.
- If the shortcut icon does not appear, press the F5 key.

### Restrictions and Problems with the Installation

The Easy Setting Box installation may be affected by the Graphics Card, Motherboard and the Networking Environment.

### System Requirements

OS	Hardware
<ul style="list-style-type: none"><li>• Windows 7 32Bit/64Bit</li><li>• Windows 8 32Bit/64Bit</li><li>• Windows 8.1 32Bit/64Bit</li><li>• Windows 10 32Bit/64Bit</li><li>• Windows 11 32Bit/64Bit</li></ul>	<ul style="list-style-type: none"><li>• At least 32MB of memory</li><li>• At least 60MB of free space on the hard disk drive</li></ul>

---

### Driver Installation

To install the latest version of the product driver, download it from the Samsung website.

(<http://www.samsung.com>)

- You can set the optimum resolution and frequency for this product by installing the corresponding drivers.

# Connections

## Read below before connecting the product.

- 1 Before connecting the product, check the shapes of both ports of the supplied signal cables and the shapes and locations of the ports on the product and external device.
  - 2 Before connecting the product, make sure you remove the power cords from both the product and the external device to prevent damage to the product due to a short circuit or over current.
  - 3 After all signal cables have been properly connected, connect the power cords back to the product and the external device.
  - 4 After connecting is completed, make sure you read the manuals to acquaint yourself with the product functions, precautions and other information required to use the product properly.
  - 5 To use Max specifications of our products, check the support specifications of the cable version you use.
- Connecting parts may differ in different products.
  - Provided ports may vary depending on the product.

## Connecting and Using a PC

Select a connection method suitable for your PC.

### Connection Using the HDMI Cable



— It is recommended to use the HDMI cable provided as components. If not provided, be sure to use authorised cable for HDMI cable connections. If you use a unauthorised HDMI cable, the image quality may be degrade.

## Connection Using an DP Cable



- It is recommended to use the DP cable provided as an accessory. If not provided, be sure to use a DP cable of 1.5 m or below.
- Use a VESA certified DP1.2 cable or higher and its gender.

## Connecting to headphones or earphones



- Use headphones or earphones when activating sound with an HDMI-HDMI or DP cable.
- The headphones or earphones jack supports only the 3 conductor tip-ring-sleeve (TRS) type.
- S27FG90\*X models are not supported.

## Connecting the Product to a PC as a USB HUB

Using the product as a hub, connect and use various source devices with the product at a time.

- S27FG50\*E / S32FG50\*E / S27FG50\*S / S27FG60\*E models are not supported.
- Port names and the number of ports may differ, depending on the model.

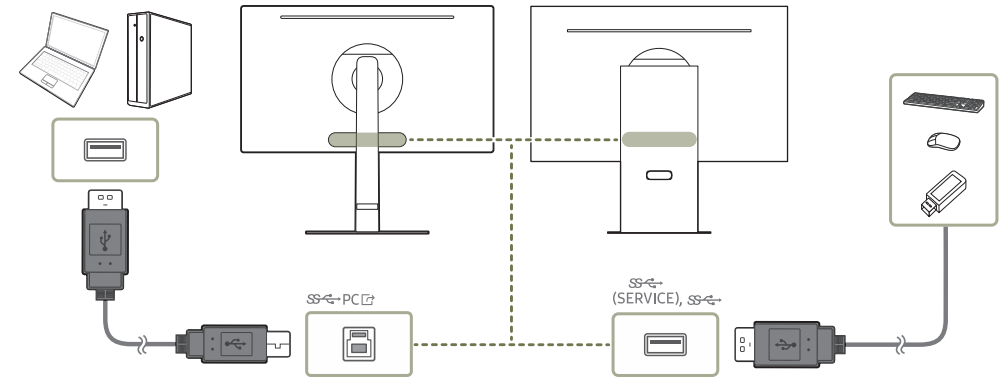

- To detect and start a USB device faster, connect the USB device to the <sup>SS</sup>-(SERVICE) <sup>SS</sup> port on the product. The read/write rate will be affected by the USB device and your PC.
- For USB-related problems caused by OS, drive programmes or software, please contact relevant suppliers.
- With the launch of various USB devices on the market, we cannot guarantee that our products are matched with all USB devices.
- For an external mass-storage HDD requiring external power supply, be sure to connect it to a power source.
- The company is not liable for problems or damages to an external device caused by using an unauthorised cable for the connection.
- Some products do not follow the USB standard, and it may cause a malfunction of the device.
- It is recommended that users use USB devices of 5V/1A or lower.

## Connecting the Power

— The images shown below are for reference only and may differ from the colors and appearances of the actual product components.

### S27FG50\*S

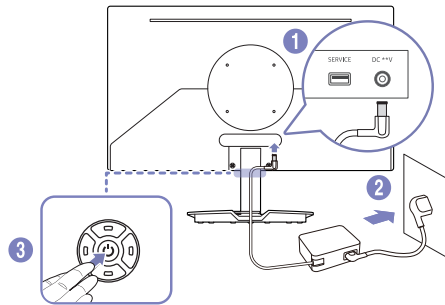

### S27FG60\*E

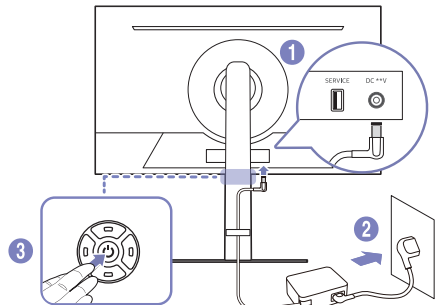

### S27FG50\*E / S32FG50\*E / S27DG60\*S / S27DG61\*S / S27FG60\*S / S27FG81\*S / S32FG81\*S

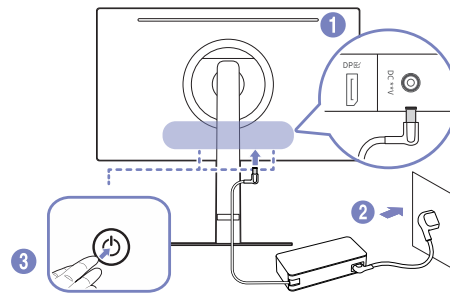

### S27FG70\* / S37FG75\* / S40FG75\*

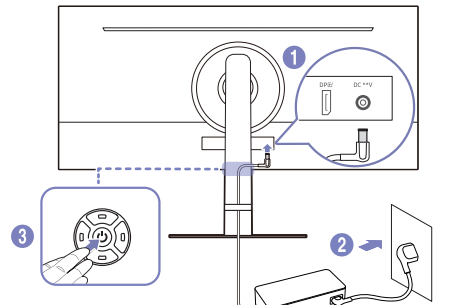

### S27FG90\*X

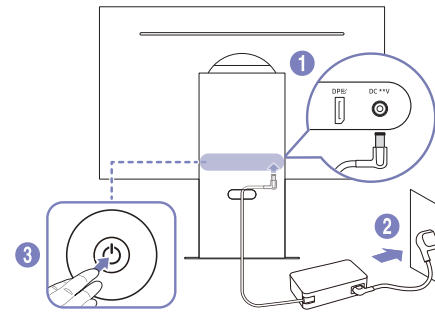

- 1 Connect the power cord to the AC/DC adapter. Then, connect the AC/DC adapter to the DC \*\*V port on the back of the product.
  - Rated power consumption for adapters differs depending on the model. Use an adapter that meets the power consumption specification of the model.
- 2 Next, connect the power cord to the power outlet.
- 3 Press the  button of the product to turn it on.

— The input voltage is switched automatically.

## Tidying Up the Cables

S27FG50\*E / S32FG50\*E

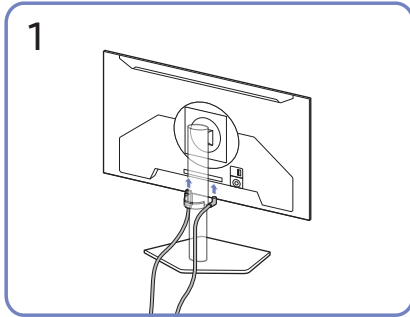

Connect the corresponding cables.

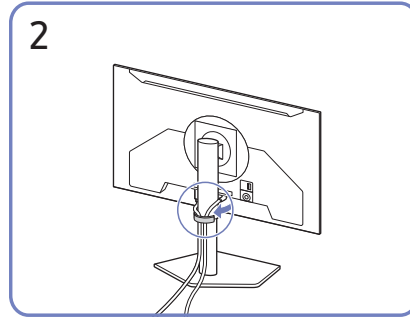

Put both cables in the cable holder on the stand (HOLDER-STAND CABLE) to organise the cables, as shown in the figure.  
Assembly is complete.

S27FG50\*S

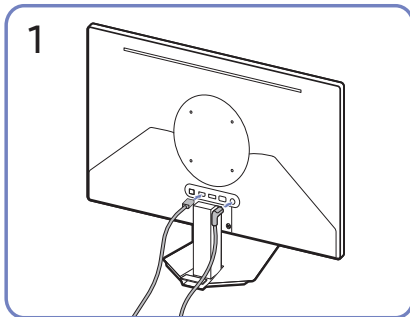

Connect the corresponding cables.

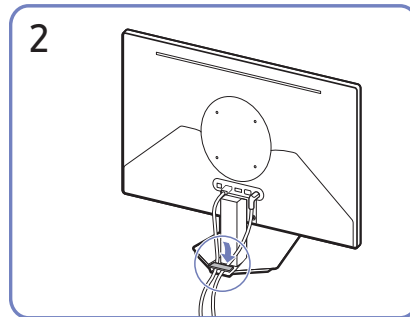

Put both cables in the cable holder on the stand (HOLDER-STAND CABLE) to organise the cables, as shown in the figure.  
Assembly is complete.

S27DG60\*S / S27DG61\*S / S27FG60\*S / S27FG60\*E / S27FG70\* / S37FG75\* / S40FG75\* / S27FG81\*S / S32FG81\*S

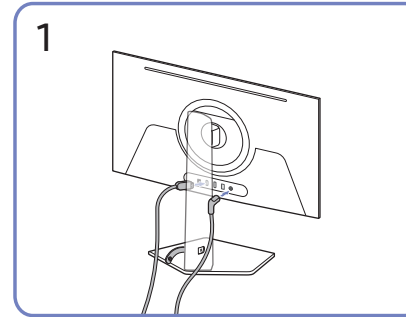

Connect the corresponding cables.

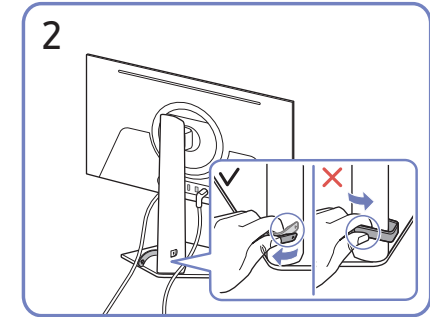

Pull the right side of the HOLDER-STAND CABLE to remove from the stand. The left side of the HOLDER-STAND CABLE can be damaged when pulled forcibly.

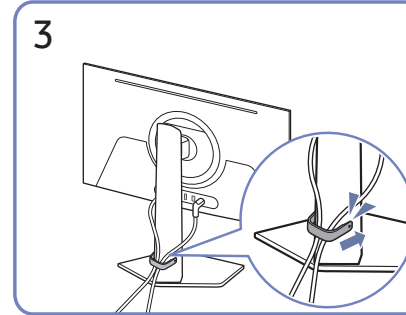

Put both cables in the cable holder on the stand (HOLDER-STAND CABLE) to organise the cables, as shown in the figure.  
Assembly is complete.

S27FG90\*X

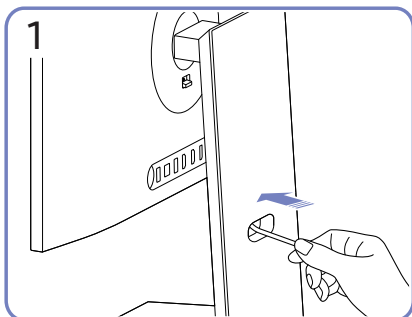

Pass cables through the hole on the stand.

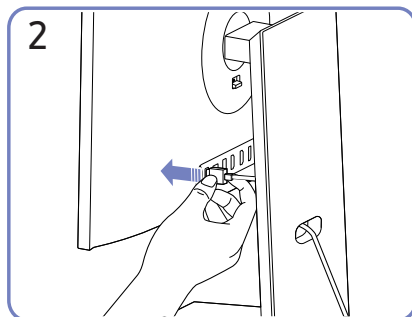

Connect the cables to the corresponding ports.

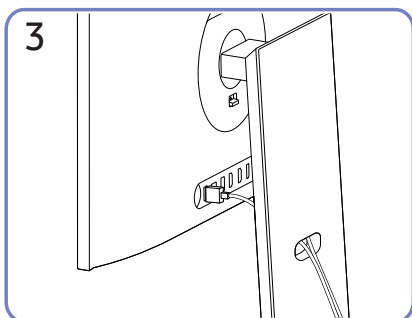

Organise cables by passing them through the hole on the stand, as shown in the figures.

## Setting Optimum Resolution

An information message about setting optimum resolution will appear if you power on the product for the first time after purchase.

Select a language on information message and change the resolution on your PC to the optimum setting.

- If the optimum resolution is not selected, the message will appear up to three times for a specified time even when the product is turned off and on again.
- To set the Optimum resolution, go to **Menu** → **System** → **Input Port Ver.** and set HDMI/DP to the maximum version.

# Using the 3D Monitor

- This feature is supported in the S27FG90\*X models only.
- Experience outstanding 3D effects through eye-tracking and view-mapping technologies, without having to wear 3D glasses.
- Play 3D games and videos through Odyssey 3D Hub.
- Convert 2D videos into 3D videos.
  - For details on your 3D monitor, please visit the Samsung website at <http://www.samsung.com>, and refer to the User guide.

## To view 3D content:

- Make sure the camera is not exposed to direct light.
- Do not cover your face, so that your entire face can be recognized.
- Center your face in the camera, and make sure the camera is pointed at your face.
- Make sure the device's screen resolution is set to 3840 x 2160.
- 3D experience is limited to one person at a time.
- Avoid making sudden, large movements of your head.
- Please watch 3D content within the recommended viewing distance (55–95 cm).
- The optimal viewing angle for watching 3D videos is 25 degrees to the left and right of the front of the screen.



## CAUTION

Before using the 3D function, read the following precautions:

- Some viewers may experience discomfort while watching 3D content, such as dizziness, nausea or headaches. If you experience these symptoms, stop watching 3D content and rest.
- Watching 3D content for long periods of time can cause eye fatigue. If this happens, please stop watching 3D and rest.

## Read before using the 3D monitor

- Users can only view games that are compatible with Samsung Odyssey 3D Hub.
- Odyssey 3D Hub is dedicated software for Odyssey 3D, and allows users to play 3D games and to convert 3D videos.
- The product's 3D conversion is only supported through the Odyssey 3D Hub software installed on a computer.
- AMD graphics cards may not convert some 2D videos to 3D.
- Some video players may not support 3D conversion.
- 3D conversion is supported on NVIDIA graphics cards only.
- In pivot mode, the **Edge Lighting** feature and 3D effects are not supported.

- To connect and use multiple monitors, set the 3D monitor as the primary monitor.
- 3D functionality may be limited when using multiple Odyssey 3D monitors.
- 3D conversion is not supported when DRM content is enabled.
- Odyssey 3D Hub may not work properly when HDR mode is enabled.
- 3D conversion supports video conversion only and may not work with games.
- To enable 3D conversion, make sure Odyssey 3D Hub is running and the video is in full screen mode.
- Available 3D effects may differ, depending on the game content and the computer specifications.
- There may be some latency during conversion from 2D videos to 3D videos.
- If you watch 3D content in a space directly exposed to sunlight or lighting, the clarity may appear poor.
- Displayed content may not be seen as intended, depending on the ambient light intensity.
- Users with a large difference in visual acuity between the left and right eyes may not be able to perceive three-dimensionality. The degree to which users perceive three-dimensionality may differ.
- Momentary screen flickering may be experienced during the process of face recognition using the eye tracking function.
- For content that is not guaranteed to be convertible to 3D using Odyssey 3D Hub, the 3D conversion performance may degrade or conversion may not work at all.
  - This feature supports video content conversion only and may not work with games.

## Installing the 3D monitor

- Before installing the monitor, check the [Recommended computer specifications](#) for Odyssey 3D Hub.
- Set the 3D input port, using the input selection menu on the product (e.g., HDMI, DP).

### 1 Connect the product to your computer, using a USB cable.

- Use the USB cable that came with the product.



### 2 Install the Odyssey 3D Hub software.

- Odyssey 3D monitors can achieve normal 3D effects through Odyssey 3D Hub software only.
- Odyssey 3D Hub software can be downloaded from the Samsung website. Alternatively, install it by searching for “Samsung Odyssey 3D Hub” in the Microsoft Store.
  - \* Downloading Odyssey 3D Hub software
    - 1) Visit the Samsung website at <http://www.samsung.com/support>.
    - 2) Search for the model name you purchased, using the model search box. (e.g., LS27FG90\*)
    - 3) Download and install the Odyssey 3D Hub software.
    - 4) Follow the on-screen instructions to complete the installation.

### 3 Reboot the computer.

- Be sure to reboot the computer after installing Odyssey 3D Hub software. If you do not reboot the computer, the software may not work properly.
- To view content at the highest refresh rate, change the related settings in the OSD menu. Change the **DisplayPort Ver.** value to **1.4** and **Input Port Ver.** value to **2.0↑**.
- From the OSD menu on the monitor, set the input source for the 3D computer’s main monitor (e.g., HDMI, DP).  
(Menu path: **Game** → **3D PC Selection** → Select Input Source)

---

## Launching Odyssey 3D Hub

- 1 Click the Odyssey 3D Hub icon on the desktop.
- 2 At the top of the screen, a red light illuminates when the camera turns on.
  - Open **Device Manager** in Windows, and check that the stereo camera is enabled.
  - If security software is installed, it may block the camera. Turn off the security settings on the computer (e.g., USB and COM port security settings).
  - If security software is blocking the camera, the camera may not open when you run the camera app in Windows.
- 3 If 3D effects are achieved on the Odyssey 3D Hub home screen, the software has been installed successfully.
  - Set **HDR** to **Off** in Windows.

## Playing a game

- 1 In Odyssey 3D Hub, click a game to open its Steam page.
- 2 Log in to the Steam site and install the desired game.
- 3 When the game installation is complete, select the installed path of the game from Odyssey 3D Hub.
- 4 Start playing the game.
  - Already-installed games automatically start when they are selected.

---

## Converting 2D to 3D

— This is supported on NVIDIA graphics cards only.

- 1 When Odyssey 3D Hub is running, run an app that supports full screen mode from the computer's desktop (e.g., YouTube).
- 2 Run the app in full screen mode.
- 3 From the bottom right of the screen of the running app, select the desired screen mode (available mode options: 2D mode and side-by-side mode).
- 4 3D conversion is performed according to the selected mode.

## Recommended computer specifications

### Minimum PC specifications for installing Odyssey 3D Hub software

#### OS

- Windows 10, 64-bit, version 22H2
- Windows 11, 64-bit

#### Hardware

- At least 4GB of free HDD space required (current installed capacity: 2.9GB)
- DDR memory with capacity of at least 2GB (PC motherboard)

### Recommended specs for 3D operation by function

Content	Function	Recommended specs	NVIDIA (PC)	AMD (PC)	Intel (PC)	Intel Notebook Graphic Card	Mac	
Video	3D conversion	CPU (Minimum)	Intel: i7 or later AMD: Ryzen7 1700X or later	Not support	Not support	Not support	Not support	
		GPU (Minimum)	3 series: RTX 3080 or later 4 series: RTX 4070 or later					
		DDR	DDR5-5600 32GB 2 ea (PC motherboard)					
		PCIe	PCIe 5.0					
	Side-by-side conversion	CPU (Minimum)	Intel: i7 or later AMD: Ryzen7 1700X or later	Intel: i7 or later AMD: Ryzen7 1700X or later	Support			
		GPU (Minimum)	3 series: RTX 3080 or later 4 series: RTX 4070 or later	6 series: RTX 6900 XT or later 7 series: RTX 7900 or later				
		DDR	DDR5-5600 32GB 2 ea (PC motherboard)					
		PCIe	PCIe 5.0					
Game	Odyssey 3D Hub Game	CPU (Minimum)	Performance is dependent of computer game content. It depends on the complexity of the game and the required computer resources (e.g., Khazan, Lies of P).	Support				
		GPU (Minimum)						
		DDR						
		PCIe						

Screen flickering or tearing may occur at low refresh rates (e.g., 60 Hz, 120 Hz), depending on the computer's graphic capability.

# Menu

Function Key Guide → 

— The functions available may vary depending on the product model. The colour and shape of parts may differ from what is shown. Specifications are subject to change without notice to improve quality.

— \*: The menu items may not be supported depending on the models.

## Game

2nd	Description
<b>3D PC Selection</b>	Select a 3D-enabled PC. — S27FG90*X models only.
<b>Response Time</b>	Accelerate the panel response rate to make video appear more vivid and natural. — It is best to set <b>Response Time</b> to <b>Standard</b> or <b>Faster</b> when you are not viewing a movie or game. — This option is not available when <b>Adaptive-Sync</b> is set to <b>On</b> . — This menu is not available when <b>PIP Mode</b> (or <b>PIP/PBP Mode</b> ) is enabled. — S27FG50*E / S32FG50*E / S27FG60*E / S27FG70* / S37FG75* / S40FG75* / S27FG90*X models only.

2nd	Description
<b>Adaptive-Sync</b>	<b>Adaptive-Sync</b> technology is solution that eliminates screen tearing without all the usual lag and latency. — This option is not available when <b>Ultrawide Game View</b> is set to <b>On</b> . (S27DG60*S / S27DG61*S / S37FG75* / S40FG75* / S27FG81*S / S32FG81*S / S27FG90*X models only.) — This menu is not available when <b>PIP Mode</b> (or <b>PIP/PBP Mode</b> ) is enabled. (S27DG60*S / S27DG61*S / S37FG75* / S40FG75* / S27FG81*S / S32FG81*S / S27FG90*X models only.) — This option is not available when DP version 1.1 or HDMI version 1.4.
<b>FreeSync / FreeSync Premium Pro / FreeSync Premium</b>	FreeSync technology is solution that eliminates screen tearing without all the usual lag and latency. FreeSync can be operated when you use AMD's graphic card with supporting FreeSync solution. For more information, see <a href="#">FreeSync (for AMD graphics card)</a> page. — This menu is not available when <b>PIP Mode</b> (or <b>PIP/PBP Mode</b> ) is enabled. (S27DG60*S / S27DG61*S / S37FG75* / S40FG75* / S27FG81*S / S32FG81*S / S27FG90*X models only.) — This option is not available when DP version 1.1 or HDMI version 1.4. — The names and positions of OSD menu items may differ, depending on the model.

2nd	Description
<b>Dual Mode</b>	<p>Provides an optimal environment by changing the resolution and refresh rate.</p> <ul style="list-style-type: none"> <li>— S27FG70* models only.</li> </ul>
<b>Ultrawide Game View</b>	<p>Set the game screen's ratio to wide for more immersive gaming.</p> <ul style="list-style-type: none"> <li>— This menu is not available when <b>PIP Mode</b> (or <b>PIP/PBP Mode</b>) is enabled.</li> <li>— This menu is not available when <b>Adaptive-Sync</b> is enabled.</li> <li>— S27FG50*E / S32FG50*E / S27FG50*S / S27FG60*S / S27FG60*E / S27FG70* / S40FG75* models are not supported.</li> </ul>

2nd	Description
<b>Black Equalizer</b>	<p>Adjust the brightness of the dark areas.</p> <p>As the value gets closer to 1, the darker areas of the screen become brighter, making it easier to find enemies when playing a game. To find enemies more easily during a game, use a lower value.</p> <p>As the value gets closer to 10, the darker areas of the screen become darker and the contrast increases.</p> <ul style="list-style-type: none"> <li>— This menu is not available when <b>Eye Saver Mode</b> is enabled.</li> <li>— The <b>Black Equalizer</b> feature is only activated at a certain <b>AV</b> resolution, such as 720P @ 60 Hz and 1080P @ 60 Hz.</li> <li>— This menu is not available when <b>PIP Mode</b> (or <b>PIP/PBP Mode</b>) is enabled. (S27DG60*S / S27DG61*S models only.)</li> </ul>
<b>Virtual Aim Point</b>	<ul style="list-style-type: none"> <li>• <b>Off:</b> <b>Virtual Aim Point</b> is not available while <b>Off</b> is selected.</li> <li>• : Select the preferred aim point style.</li> <li>• <b>Reset Position:</b> Restore the aim point position to the default.</li> </ul> <ul style="list-style-type: none"> <li>— This menu is not available when <b>PIP Mode</b> (or <b>PIP/PBP Mode</b>) is enabled. (S27FG50*E / S32FG50*E / S27DG60*S / S27DG61*S / S37FG75* / S40FG75* / S27FG81*S / S32FG81*S / S27FG90*X models only.)</li> </ul>

2nd	Description
<b>*Virtual Aim Point</b>	<p>Displays the <b>Aim Point</b>.</p> <p>— S27FG50*S / S27FG70* models only.</p> <p><b>Aim Point:</b> Displays the aim point on the screen, which helps users aim more accurately while playing games.</p> <ul style="list-style-type: none"> <li>• <b>Off:</b> <b>Aim Point</b> is not available while <b>Off</b> is selected.</li> <li>• : Select the preferred aim point style.</li> </ul> <p>— This function may differ depending on the model.</p> <p><b>Color:</b> Allows users to manually choose a preferred colour for the aim point.</p> <ul style="list-style-type: none"> <li>• <b>AI Mode:</b> Automatically optimise the aiming point colour to suit the gaming environment, using artificial intelligence technology.</li> <li>• <b>Red, Blue, White:</b> Allows users to choose a default colour for the aiming colour. Users can configure aim point settings to suit their preferences and gaming environment.</li> </ul> <p><b>Reset Position:</b> Restore the aim point position to the default.</p>
<b>Infinity Core Lighting</b>	<p>Turn on or off the LED lighting behind the screen.</p> <p>— S27DG60*S / S27FG60*S / S37FG75* / S40FG75* / S27FG81*S / S32FG81*S models only.</p>
<b>Edge Lighting</b>	<p>Adjust the brightness of the LED lighting under the screen.</p> <p>— S27FG90*X models only.</p>

2nd	Description
<b>Screen Size</b>	<p>Select the best screen size and ratio.</p> <p>— This option is not available when <b>Ultrawide Game View</b> is set to <b>On</b>. (S27DG60*S / S27DG61*S / S37FG75* / S40FG75* / S27FG81*S / S32FG81*S / S27FG90*X models only.)</p> <p>— This menu is not available when <b>PIP Mode</b> (or <b>PIP/PBP Mode</b>) is enabled. (S27DG60*S / S27DG61*S / S37FG75* / S40FG75* / S27FG81*S / S32FG81*S / S27FG90*X models only.)</p> <p>In <b>PC</b> mode</p> <ul style="list-style-type: none"> <li>• <b>Auto:</b> Display the picture according to the aspect ratio of the input source.</li> <li>• <b>Wide:</b> Display the picture in full screen regardless of the aspect ratio of the input source.</li> </ul> <p>In <b>AV</b> mode</p> <ul style="list-style-type: none"> <li>• <b>4:3:</b> Display the picture with an aspect ratio of 4:3. Suitable for videos and standard broadcasts.</li> <li>• <b>21:9:</b> Display the picture with an aspect ratio of 21:9.</li> </ul> <p>— S27FG50*E / S32FG50*E / S27FG50*S / S27FG70* models are not supported.</p> <ul style="list-style-type: none"> <li>• <b>16:9:</b> Display the picture with an aspect ratio of 16:9.</li> <li>• <b>Screen Fit:</b> Display the picture with the original aspect ratio without cutting off.</li> </ul> <p>— The function may not be supported depending on the ports provided with the product.</p> <p>— Changing the <b>Screen Size</b> is available when the following conditions are satisfied.</p> <ul style="list-style-type: none"> <li>— The input source is 480p, 576p, 720p, or 1080p and product can display normally (Not every model can support all of these signals.).</li> <li>— This can only be set when the external input is connected through HDMI/DP and <b>PC/AV Mode</b> is set to <b>AV</b>.</li> </ul>

# Picture

2nd	Description
<b>Picture Mode</b>	<p>This menu provides an optimum picture quality suitable for the environment where the product will be used.</p> <ul style="list-style-type: none"> <li>— This menu is not available when <b>PIP Mode</b> (or <b>PIP/PBP Mode</b>) is enabled. (S27DG60*S / S27DG61*S models only.)</li> <li>— This menu is not available when <b>Eye Saver Mode</b> is enabled.</li> </ul> <p>In <b>PC</b> mode</p> <ul style="list-style-type: none"> <li>• <b>Entertain</b>: Obtain the clear and vivid picture quality with colour enhancement.</li> <li>• <b>Graphic</b>: Obtain the quality of Image contents without colour enhancement.</li> <li>• <b>Eco</b>: This screen is provided to save energy.</li> <li>• <b>Game Standard</b>: Obtain a picture quality suitable for playing games.</li> <li>• <b>RPG</b>: This mode is optimised for 3D graphics and instant messaging on the RPG (Role Playing Game) game screen.</li> <li>• <b>RTS</b>: Increase the colour temperature and contrast ratio to improve visibility of the RTS (Real-Time Strategy) screen and minimap.</li> <li>• <b>FPS</b>: Increase the brightness of darker areas of the FPS (First-Person Shooter) game screen. This mode increases visibility of your enemies during a FPS (First-Person Shooter) game.</li> <li>• <b>Sports</b>: Obtain the brightness and sharpness of monitors suitable for enjoying sports contents.</li> <li>• <b>Original</b>: Obtain the pure picture quality of contents without colour enhancement.</li> <li>• <b>Custom</b>: Customise the screen settings.</li> </ul>

2nd	Description
<b>Picture Mode</b>	<p>In <b>AV</b> mode</p> <p>When the external input is connected through HDMI/DP and <b>PC/AV Mode</b> is set to <b>AV</b>, <b>Picture Mode</b> has eleven picture settings (<b>Dynamic</b>, <b>Standard</b>, <b>Eco</b>, <b>Movie</b>, <b>Game Standard</b>, <b>RPG</b>, <b>RTS</b>, <b>FPS</b>, <b>Sports</b>, <b>Original</b>, <b>Custom</b>) that are preset at the factory. You can activate either <b>Dynamic</b>, <b>Standard</b>, <b>Eco</b>, <b>Movie</b>, <b>Game Standard</b>, <b>RPG</b>, <b>RTS</b>, <b>FPS</b>, <b>Sports</b>, <b>Original</b> or <b>Custom</b>. You can select <b>Custom</b> which automatically recalls your personalised picture settings.</p> <ul style="list-style-type: none"> <li>• <b>Dynamic</b>: Select this mode to view a sharper image than in <b>Standard</b> mode.</li> <li>• <b>Standard</b>: Select this mode when the surroundings are bright.</li> <li>• <b>Eco</b>: This screen is provided to save energy.</li> <li>• <b>Movie</b>: Select this mode when the surroundings are dark. This will save power and reduce eye fatigue.</li> <li>• <b>Game Standard</b>: Obtain a picture quality suitable for playing games.</li> <li>• <b>RPG</b>: This mode is optimised for 3D graphics and instant messaging on the RPG (Role Playing Game) game screen.</li> </ul>

2nd	Description
<b>Picture Mode</b>	<ul style="list-style-type: none"> <li>• <b>RTS:</b> Increase the colour temperature and contrast ratio to improve visibility of the RTS (Real-Time Strategy) screen and minimap.</li> <li>• <b>FPS:</b> Increase the brightness of darker areas of the FPS (First-Person Shooter) game screen. This mode increases visibility of your enemies during a FPS (First-Person Shooter) game.</li> <li>• <b>Sports:</b> Obtain the brightness and sharpness of monitors suitable for enjoying sports contents.</li> <li>• <b>Original:</b> Obtain the pure picture quality of contents without colour enhancement.</li> <li>• <b>Custom:</b> Select this mode when you want to adjust the image according to your preferences.</li> </ul> <p>— The <b>Picture Mode</b> feature is only activated at a certain <b>AV</b> resolution, such as 720P @ 60 Hz, 1080P @ 60 Hz and 2160P @ 60 Hz.</p>
<b>Brightness</b>	<p>You can adjust the general brightness of the picture. (Range: 0~50)</p> <p>A higher value will make the picture appear brighter.</p> <p>— This menu is not available when <b>Eye Saver Mode</b> is enabled.</p>

2nd	Description
<b>Contrast</b>	<p>Adjust the contrast between the objects and background. (Range: 0~50)</p> <p>A higher value will increase the contrast to make the object appear clearer.</p> <p>— This menu is not available when <b>PIP Mode</b> (or <b>PIP/PBP Mode</b>) is enabled. (S27DG60*S / S27DG61*S models only.)</p>
<b>Sharpness</b>	<p>Make the outline of objects more clear or blurry. (Range: 0~20)</p> <p>A higher value will make the outline of objects clearer.</p> <p>— This menu is not available when <b>PIP Mode</b> (or <b>PIP/PBP Mode</b>) is enabled. (S27DG60*S / S27DG61*S models only.)</p>
<b>Color</b>	<p>Adjust the colour saturation levels. Colour saturation intensifies as the value nears 50. (Range: 0~50)</p> <p>— This menu is not available when <b>PIP Mode</b> (or <b>PIP/PBP Mode</b>) is enabled. (S27DG60*S / S27DG61*S models only.)</p> <p>— This menu is not available when <b>Eye Saver Mode</b> is enabled.</p>

2nd	Description
<b>Tint (G/R)</b>	<p>Adjust the ratio of green to red tint levels. Increasing values intensifies the saturation of red and green colours.</p> <ul style="list-style-type: none"> <li>— This menu is not available when <b>PIP Mode</b> (or <b>PIP/PBP Mode</b>) is enabled. (S27DG60*S / S27DG61*S models only.)</li> <li>— This menu is not available when <b>Eye Saver Mode</b> is enabled.</li> </ul>
<b>Local Dimming</b>	<p>Control the brightness of individual areas on the screen to maximize contrast automatically.</p> <ul style="list-style-type: none"> <li>— This menu is not available when <b>PIP Mode</b> (or <b>PIP/PBP Mode</b>) is enabled.</li> <li>— This menu is not available when <b>Eye Saver Mode</b> is enabled.</li> <li>— S27FG60*E / S27FG70* / S37FG75* / S40FG75* / S27FG90*X models only.</li> </ul>
<b>Contrast Enhancer</b>	<p>Automatically balance the contrast to prevent excessive differences between bright and dark areas.</p> <ul style="list-style-type: none"> <li>— This menu is not available when <b>PIP Mode</b> (or <b>PIP/PBP Mode</b>) is enabled. (S27DG60*S / S27DG61*S models only.)</li> <li>— This menu is not available when <b>Eye Saver Mode</b> is enabled.</li> </ul>

2nd	Description
<b>HDR Tone Mapping</b>	<p>Automatically adjusts the brightness with tone mapping processing according to HDR content information.</p> <ul style="list-style-type: none"> <li>— This menu is not available when <b>PIP Mode</b> (or <b>PIP/PBP Mode</b>) is enabled. (S27DG60*S / S27DG61*S / S37FG75* / S40FG75* / S27FG81*S / S32FG81*S / S27FG90*X models only.)</li> </ul>
<b>Color Tone</b>	<p>Select a colour tone that best suits your viewing needs.</p> <ul style="list-style-type: none"> <li>— This menu is not available when <b>PIP Mode</b> (or <b>PIP/PBP Mode</b>) is enabled. (S27DG60*S / S27DG61*S models only.)</li> <li>— This menu is not available when <b>Eye Saver Mode</b> is enabled.</li> </ul>
<b>White Balance</b>	<p>Adjust the colour temperature of the picture so that white objects appear brighter.</p> <ul style="list-style-type: none"> <li>— This menu is not available when <b>PIP Mode</b> (or <b>PIP/PBP Mode</b>) is enabled. (S27DG60*S / S27DG61*S models only.)</li> <li>— This menu is not available when <b>Eye Saver Mode</b> is enabled.</li> </ul>
	<b>Red</b>
	Adjust the red saturation level. Values closer to 50 mean greater intensity for the colour.
	<b>Green</b>
	Adjust the green saturation level. Values closer to 50 mean greater intensity for the colour.
	<b>Blue</b>
	Adjust the blue saturation level. Values closer to 50 mean greater intensity for the colour.
	<b>Reset</b>
	Restore the white balance settings to the default values.

2nd	Description
<b>Gamma</b>	<p>Adjust the middle level of luminance.</p> <ul style="list-style-type: none"> <li>— This menu is not available when <b>PIP Mode</b> (or <b>PIP/PBP Mode</b>) is enabled. (S27DG60*S / S27DG61*S models only.)</li> <li>— This menu is not available when <b>Eye Saver Mode</b> is enabled.</li> </ul>
<b>Shadow Detail</b>	<p>Adjust the brightness of dark images. Black detail increases as the value nears 5.</p> <ul style="list-style-type: none"> <li>— This menu is not available when <b>PIP Mode</b> (or <b>PIP/PBP Mode</b>) is enabled. (S27DG60*S / S27DG61*S models only.)</li> <li>— This menu is not available when <b>Eye Saver Mode</b> is enabled.</li> </ul>
<b>Color Space Settings / Color Space</b>	<p>Configure colour space settings to refine the spectrum of colours on your screen.</p> <ul style="list-style-type: none"> <li>— This menu is not available when <b>PIP Mode</b> (or <b>PIP/PBP Mode</b>) is enabled. (S27DG60*S / S27DG61*S models only.)</li> <li>— This menu is not available when <b>Eye Saver Mode</b> is enabled.</li> <li>— The names and positions of OSD menu items may differ, depending on the model.</li> </ul>

2nd	Description
<b>Peak Brightness</b>	<p>Adjust the maximum brightness for a brighter screen.</p> <ul style="list-style-type: none"> <li>— This menu is not available when <b>PIP Mode</b> (or <b>PIP/PBP Mode</b>) is enabled.</li> <li>— This menu is not available when <b>Eye Saver Mode</b> is enabled.</li> <li>— S27DG60*S / S27DG61*S / S27FG60*S / S27FG81*S / S32FG81*S models only.</li> </ul>
<b>Dynamic Brightness</b>	<p>Automatically adjust the Brightness to provide the best possible screen contrast under the current conditions.</p> <ul style="list-style-type: none"> <li>— This menu is not available when <b>Eye Saver Mode</b> is enabled.</li> <li>— This menu is not available when <b>PIP Mode</b> (or <b>PIP/PBP Mode</b>) is enabled.</li> <li>— This menu is disabled when the <b>Local Dimming</b> feature is set to <b>Low / Standard / High</b>.</li> <li>— S27FG50*E / S32FG50*E / S37FG75* / S40FG75* models only.</li> </ul>

2nd	Description
<b>Black Level</b>	<p>If a DVD player or set-top box is connected to the product via HDMI, image quality degradation (contrast/colour degradation, black level, etc.) may occur, depending on the connected source device.</p> <p>In such case, <b>Black Level</b> can be used to adjust the image quality.</p> <ul style="list-style-type: none"> <li>• <b>Auto</b>: Select this mode if you want <b>Normal</b> or <b>Low</b> to be automatically selected depending on the signal.</li> <li>• <b>Normal</b>: Select this mode when there is no contrast ratio degradation.</li> <li>• <b>Low</b>: Select this mode to reduce the black level and increase the white level when there is a contrast ratio degradation.</li> </ul> <p>— This menu is not available when <b>PIP Mode</b> (or <b>PIP/PBP Mode</b>) is enabled. (S27DG60*S / S27DG61*S / S37FG75* / S40FG75* / S27FG81*S / S32FG81*S / S27FG90*X models only.)</p> <p>— This function is only available in <b>HDMI</b> mode.</p> <p>— <b>Black Level</b> may not be compatible with some source devices.</p> <p>— Adjust the <b>Black Level</b> because the image quality may differ depending on the external device.</p>

2nd	Description
<b>Eye Saver Mode</b>	<p>Set to an optimum picture quality suitable for eye relaxation.</p> <p>When <b>Eye Saver Mode</b> is 'On', the blue light that wavelength is around 400nm will decrease, and it will provide an optimum picture quality suitable for eye relaxation.</p>
<b>Screen Adjustment</b>	<ul style="list-style-type: none"> <li>• <b>H-Position</b>: Move the screen to the left or right.</li> <li>• <b>V-Position</b>: Move the screen up or down.</li> </ul> <p>— This option is only available when <b>PC/AV Mode</b> is set to <b>AV</b>.</p> <p>— This menu is only available when <b>Screen Size</b> is set to <b>Screen Fit</b> in <b>AV Mode</b>. When a 480P, 576P, 720P or 1080p signal is input in <b>AV</b> mode and the product can display normally, select <b>Screen Fit</b> to adjust horizontal position and vertical position in 0-6 levels.</p> <p>— This menu is only available when <b>Adaptive-Sync</b> is set to <b>Off</b> in <b>AV Mode</b>.</p>
<b>Calibration Report</b>	<p>View the <b>Calibration Report</b>.</p> <p>— S27FG70* / S37FG75* / S40FG75* / S27FG81*S / S32FG81*S / S27FG90*X models only.</p>
<b>Picture Reset</b>	<p>Restore all picture settings to the factory default.</p>

---

## PIP(PIP/PBP)

— S27FG50\*E / S32FG50\*E / S27FG50\*S / S27FG60\*E / S27FG60\*S / S27FG70\* models are not supported.

2nd	Description
<b>PIP Mode</b> (or <b>PIP/PBP Mode</b> )	Turn <b>PIP Mode</b> (or <b>PIP/PBP Mode</b> ) on or off. — This function may differ depending on the model.
<b>Mode Type</b>	Select the size and aspect ratio of the sub-screen.
<b>Screen Size</b>	Select sub-screen size.
<b>Screen Position</b>	Select the position of the sub-screen from the available options.
<b>Source</b>	Select the source for each screen.
<b>Sound Source</b>	Set which screen you want to hear the sound for.
<b>Screen Ratio</b>	Choose the size and aspect ratio of the picture displayed on screen. In <b>PC</b> mode <ul style="list-style-type: none"><li>• <b>Auto / Wide</b></li></ul> In <b>AV</b> mode <ul style="list-style-type: none"><li>• <b>4:3 / 16:9 / 21:9 / Screen Fit</b></li></ul> — The function may not be supported depending on the ports provided with the product. — Changing the <b>Screen Ratio</b> is available when the following conditions are satisfied. <ul style="list-style-type: none"><li>— The input source is 480p, 576p, 720p, 1080p or 2160p and product can display normally (Not every model can support all of these signals.).</li><li>— This can only be set when the external input is connected through HDMI, DP and <b>PC/AV Mode</b> is set to <b>AV</b>.</li><li>— The <b>Screen Ratio</b> feature is only activated at a certain <b>AV</b> resolution, such as 720P @ 60 Hz, 1080P @ 60 Hz and 2160P @ 60 Hz.</li></ul>

---

---

## OnScreen Display





2nd	Description
<b>Language</b>	Set the menu language. — A change to the language setting will only be applied to the onscreen menu display. — It will not be applied to other functions on your PC.
<b>Display Time</b>	The OSD menu will automatically disappear if the menu is not used for a specified period of time. <b>Display Time</b> is a function to specify the time which you want the OSD menu to disappear.





---

## System

2nd	Description
<b>SeeColors Mode</b>	Allows users with colour blindness to experience rich colours. Enable this feature to customise colours to suit your viewing conditions, to experience richer colours on the screen. — Some menus are not available when <b>SeeColors Mode</b> is in use. — This function may not be supported depending on the model.
<b>Save Energy</b>	Reduce power consumption by adjusting brightness settings.

---

2nd	Description
 <b>Volume</b>	<p>Adjust the <b>Volume</b> controlling the 5-Way /  button LEFT/RIGHT.</p> <ul style="list-style-type: none"> <li>To activate the <b>Mute</b> function, access the <b>Volume</b> control screen, then use the 5-Way /  button to move the focus down.</li> <li>To deactivate the <b>Mute</b> function, access the <b>Volume</b> control screen, then increase or decrease the <b>Volume</b>.</li> </ul>
<b>Off Timer Plus</b>	<p><b>Off Timer</b></p> <ul style="list-style-type: none"> <li><b>Off Timer:</b> Turn on <b>Off Timer</b> mode.</li> <li><b>Turn Off After:</b> The off timer can be set within a range of 1 to 23 hours. The product will automatically power off after the specified number of hours. <ul style="list-style-type: none"> <li>This option is only available when <b>Off Timer</b> is set to <b>On</b>.</li> </ul> </li> </ul> <p>For products for the market in some regions, the <b>Off Timer</b> is set to automatically activate 4 hours after the product powers on. This is done in accordance with power supply regulations. If you do not want the timer to activate, go to  → <b>System</b> → <b>Off Timer Plus</b> and set <b>Off Timer</b> to <b>Off</b>.</p> <hr/> <p><b>Eco Timer</b></p> <ul style="list-style-type: none"> <li><b>Eco Timer:</b> Turn on <b>Eco Timer</b> mode.</li> <li><b>Eco Off After:</b> The <b>Eco Off After</b> can be set between 10 and 180 minutes. The product will automatically power off after the specified time has elapsed. <ul style="list-style-type: none"> <li>This option is only available when <b>Eco Timer</b> is set to <b>On</b>.</li> </ul> </li> </ul>

2nd	Description
<b>PC/AV Mode</b>	<p>Set <b>PC/AV Mode</b> to <b>AV</b>. The picture size will be enlarged.</p> <p>This option is useful when you view a movie.</p> <ul style="list-style-type: none"> <li>Products with a display area of 16:9 or 16:10 are only supported.</li> <li>If the product is in <b>HDMI, DisplayPort</b> mode and the screen says <b>Check the cable connection and the settings of the source device</b>, press the 5-Way /  button to display the Function Key Guide screen and then select  → <b>System</b> → <b>PC/AV Mode</b> → <b>HDMI, DisplayPort</b> → <b>PC</b> or <b>AV</b>.</li> </ul>
<b>DisplayPort Ver.</b>	<p>Select your Displayport.</p> <ul style="list-style-type: none"> <li>Incorrect settings may cause the screen to go blank. If this occurs, check the device specifications.</li> <li>If the product (in <b>DisplayPort</b> mode) is displaying the message <b>Check the cable connection and the settings of the source device</b>, press the 5-Way /  button to display the Function Key Guide screen and then select  → <b>System</b> → <b>DisplayPort Ver.</b>.</li> <li>If <b>DisplayPort Ver.</b> is set to <b>1.1</b>, the graphics card's actual maximum output refresh rate may not reach the maximum level, due to the bandwidth limitation of the DisplayPort 1.1 protocol.</li> <li>If the PC has entered BIOS mode and the BIOS screen does not appear, go to the following path and then select the mode.  → <b>System</b> → <b>DisplayPort Ver.</b>.</li> </ul>

2nd	Description
<b>Input Port Ver.</b>	<p>Select an HDMI version. (1.4 / 2.0↑)</p> <ul style="list-style-type: none"> <li>— The supportable device and resolution may differ depending on its version.</li> <li>— When the version is changed, the screen may blink.</li> <li>— If you set the HDMI mode to 1.4, some high resolutions may not be supported because of bandwidth limitation of the HDMI 1.4 protocol.</li> <li>— When the setting is not appropriate, a blank screen may appear. In this case, check the specifications of the device.</li> <li>— Set HDMI mode to 1.4 if the monitor is connected to an HDMI device and the monitor does not display the screen properly, displays a blank screen, or does not play sound at all.</li> </ul>
<b>Auto Source Switch+</b>	<p>By activating, a new connected source is displayed automatically.</p> <ul style="list-style-type: none"> <li>— This function may not be supported depending on the model or geographical area.</li> </ul>

2nd	Description
<b>Panel Care</b>	<p>Adjusts settings to protect the screen.</p> <p>Protects the panel to prevent problems with the product screen.</p> <ul style="list-style-type: none"> <li>— If your OLED Product displays the same still image for 10 minutes, <b>Screen Saver</b> is automatically activated. <b>Screen Saver</b> cannot be turned off, to ensure protection of pixels.</li> </ul> <p>Precautions for preventing image retention</p> <ul style="list-style-type: none"> <li>• If a still screen is displayed for an extended period of time, image retention or bad pixels may occur.</li> </ul> <ul style="list-style-type: none"> <li>— Examples of still screens that cause image retention. <ul style="list-style-type: none"> <li>— A still image, or an image with objects fixed to a spot (e.g., desktop icon, fixed windows such as menus, logos, etc).</li> <li>— Menu items or icons fixed to a spot in a web browser or webpage.</li> <li>— The icons or logos of menu items or source devices (e.g., game console, set top box, PC, etc) fixed to a spot.</li> <li>— A playing video being kept paused for an extended period of time.</li> <li>— Use of an input source that has a different aspect ratio from the screen size for an extended period of time (e.g., full screen mode of 16:9 or 4:3 ratio videos).</li> </ul> </li> <li>• To prevent image retention and other issues with the product screen, the Panel Care feature protects the screen.</li> </ul> <ul style="list-style-type: none"> <li>— This function is supported on the OLED model only.</li> </ul> <p><b>Logo Brightness</b></p> <p>Prevents screen issues by lowering the brightness of fixed images, such as logos and banners.</p> <p><b>Pixel Refresh</b></p> <p>Adjusts pixels to provide a clearer screen.</p>

2nd	Description
<b>Key Repeat Time</b>	Control the response rate of a button when the button is pressed. <b>Acceleration</b> , <b>1 sec</b> , or <b>2 sec</b> can be selected. If <b>No Repeat</b> is selected, a command responds only once when a button is pressed.
<b>Power LED On</b>	Configure the settings to enable or disable the power LED located at the lower part of the product. <ul style="list-style-type: none"> <li><b>Working</b>: The power LED is on when the product is turned on.</li> <li><b>Stand-by</b>: The power LED is on when the product is turned off.</li> </ul>

2nd	Description
<b>Setup Custom Key</b>	Set the custom key so that your chosen function can be set up directly. <ul style="list-style-type: none"> <li><b>Eye Saver Mode / PIP / PIP/PBP / Ultrawide Game View / Dual Mode / Black Equalizer / Virtual Aim Point / Infinity Core Lighting / Auto Source Switch+ / Picture Mode / Response Time</b></li> </ul> <p>— <b>PIP</b> is only available on the S27DG60*S / S27DG61*S / S37FG75* / S27FG81*S / S32FG81*S / S27FG90*X models.</p> <p>— <b>PIP/PBP</b> is only available on the S40FG75* models.</p> <p>— <b>Ultrawide Game View</b> is only available on the S27DG60*S / S27DG61*S / S37FG75* / S27FG81*S / S32FG81*S / S27FG90*X models.</p> <p>— <b>Infinity Core Lighting</b> is only available on the S27DG60*S / S27FG60*S / S37FG75* / S40FG75* / S27FG81*S / S32FG81*S models.</p> <p>— <b>Response Time</b> is only available on the S27FG50*E / S32FG50*E / S27FG60*E / S27FG70* / S37FG75* / S40FG75* models.</p> <p>— <b>Dual Mode</b> is only available on the S27FG70* models.</p>
<b>VRR Control</b>	By optimising the video signal processing, this additional function mitigates screen flicker. While playing any game or content that causes screen flicker, use the <b>VRR Control</b> function with setting it to <b>On</b> . — S27FG50*E / S32FG50*E / S27FG70* models are not supported.

# Support

2nd	Description
<b>Self Diagnosis</b>	<p>Perform this test when you experience a problem with your monitor's picture.</p> <ul style="list-style-type: none"> <li>Never turn off the power nor change the input source during self diagnosis. If possible, try not to interrupt testing.</li> </ul>
<b>Software Update</b>	<p>Update software using an update file on a USB device.</p> <ol style="list-style-type: none"> <li>Save the update file (in .bin or .img format) that you downloaded from the Samsung website (<a href="http://www.samsung.com">http://www.samsung.com</a>) to a USB storage device.</li> <li>Connect the USB device to the <sup>SS←</sup>(SERVICE) port on the monitor. Select  → <b>Support</b> → <b>Software Update</b>.</li> <li>Follow the instructions on the screen to proceed with update.</li> <li>Your product will turn itself off and on again automatically after completing update, and then turn off your product.</li> <li>Remove the power cord from the power outlet and then reconnect the cord after turning off.</li> </ol> <ul style="list-style-type: none"> <li>To perform software update by using a USB memory, first format the USB memory to FAT32.</li> <li>When performing update, make sure that only one BIN or IMG file (.bin or .img) is saved in the root directory.</li> <li>Upon updates, save only either the .bin or .image file, downloaded from the Samsung website, to the root directory.</li> <li>If the <b>No update files found on your USB device. Please check your USB device and try again.</b> message is displayed, this is probably due to the following reasons.</li> </ul>

2nd	Description
<b>Software Update</b>	<ul style="list-style-type: none"> <li>A USB memory is not connected to the <sup>SS←</sup>(SERVICE) port.</li> <li>The files in the connected USB memory are not compatible formats.</li> <li>There are no valid update files found in the connected USB memory. (There are no update files saved in the memory or the file names are incorrect.)</li> <li>Do not turn off the product until the update is complete. And prevent the updating from any interruption as far as possible. In general, the product returns to the previous version if an update is interrupted.</li> <li>It may change the screen colour or blink during USB update, but it is not a monitor problem. Since S/W update is performed normally, please wait until the update is finished.</li> </ul>
<b>Information</b>	View product information like model name.
<b>Register Product</b>	Discover how to register your product.
<b>Reset All</b>	Return all the settings for the product to the default factory settings.

# Troubleshooting

## Requirements Before Contacting Samsung Customer Service Centre

— Before calling Samsung Customer Service Centre, test your product as follows. If the problem persists, contact Samsung Customer Service Centre.

### Product diagnosis (Screen issue)

If a problem occurs with the monitor screen, run [Self Diagnosis](#) to check that the monitor is working properly.

### Checking the Resolution and Frequency

If a resolution that is not supported (see the [Standard Signal Mode Table](#)) is selected, the **Not Optimum Mode** message may appear for a short time or the screen may not be displayed properly.

— The displayed resolution may vary, depending on the PC system settings and cables.

## Check the following.

### Installation issue (PC mode)

---

Blank spaces are found on all four sides of the screen when an HDMI cable is connected to the product and PC.

The blank spaces found on the screen have nothing to do with the product.

Blank spaces on the screen are caused by the PC or graphics card. To resolve the problem, adjust the screen size in the HDMI settings for the graphics card.

If the graphics card settings menu does not have an option to adjust the screen size, update the graphics card driver to the latest version.

(Please contact the graphics card or PC manufacturer for further details about how to adjust the screen settings.)

---

---

## Screen issue

---

**The power LED is off. The screen will not turn on.**

Check that the power cord is connected properly.

If a problem occurs with the monitor screen, run [Self Diagnosis](#) to check that the monitor is working properly.

---

**The message *Check the cable connection and the settings of the source device.* appears.**

Check that the cable is properly connected to the product.

If the monitor is in **HDMI** or **DisplayPort** mode, press the  button to display the Function Key Guide screen and select the  → **System** → **PC/AV Mode** → **HDMI, DisplayPort** → **PC** or **AV**.

---

**Not Optimum Mode is displayed.**

This message appears when the signal from the graphics card exceeds the maximum resolution or frequency for the product.

Change the maximum resolution and frequency to suit the product performance, referring to [Standard Signal Mode Table](#).

---

**The images on the screen look distorted.**

Check the cable connection to the product.

---

**The screen is not clear. The screen is blurry.**

Remove any accessories (video extension cable, etc.) and try again.

Set the resolution and frequency to the recommended level.

---

**The screen appears unstable and shaky. There are shadows or ghost images left on the screen.**

Check that the resolution and frequency for the PC are within the range of resolution and frequency compatible with the product. Next, if required, change the settings, referring to [Standard Signal Mode Table](#) in this manual and the **Information** menu on the product.

— Available functions may differ depending on the model.

---

---

**The screen is too bright. The screen is too dark.**

Adjust **Brightness** and **Contrast**.

---

**Screen colour is inconsistent.**

Change the **Color** settings.

---

**The colours on the screen have a shadow and are distorted.**

Change the **Color** settings.

---

**White does not really look white.**

Change the **Color** settings.

---

**There is no image on the screen and the power LED blinks every 0.5 to 1 second.**

Check the cable connection between the product and PC, and ensure the connectors are locked.

Press any key on the keyboard or move the mouse to return to normal operating mode.

The product is operating in power-saving mode.

---

**Text is blurry.**

If using a Windows OS (e.g. Windows 7, Windows 8, Windows 8.1 or Windows 10): Go to **Control Panel** → **Fonts** → **Adjust ClearType text** and change **Turn on ClearType**.

---

**Video playback is choppy.**

Playback of high-definition large video files can be choppy. This may be because the video player is not optimised for the PC resource.

Try playing the file on another video player.

---

---

## Sound issue

---

### There is no sound.

Re-check the condition of the connected headphone or earphone or adjust the volume.

Check the volume.

Check whether the volume of the product or the source device is set to mute.

---

### The volume is too low.

Adjust the volume.

If the volume is still low after turning it up to the maximum level, adjust the volume on your PC sound card or software.

---

### Video is available but there is no sound.

Sound cannot be heard if an HDMI-DVI cable is used to connect the input device.

Connect the device using an HDMI cable or a DP cable.

---

## Source device issue

---

### A beeping sound is heard when my PC is booting.

If a beeping sound is heard when your PC is booting, have your PC serviced.

---

---

## Issues related to the stereo camera

---

The LED indicator camera at the top of the monitor does not work when using 3D.

Reset the camera if it does not work.

### Resetting the camera

- The camera can be reset by removing the USB cable from the product and computer.
  - Use the Device Manager in Windows on the computer.
    - On the computer, navigate to **Device Manager** → **Cameras** → right-click with the mouse on **3D Stereo WebCam** → click **Disable device** menu to change it to **Enable device**.
  - Turn the monitor off and then on again to reset the camera.
- 

## Other issue

---

### When the product makes popping (cracking) sound.

The sound may be caused by contraction or expansion from temperature change of external components or internal circuit of the product.

This is NOT a product failure and does not affect the life of the product.

---

### The product is getting hot.

It is normal for the product to generate some heat when used. The product has been tested and proven to be safe. You can use it with confidence. The heat generated by the product when used does not affect its performance or lifespan.

---

# Specifications

## General

Model Name	S32FG50*E	S27FG50*S
Size	80.1 cm	67.8 cm
Display area	698.112 mm (H) x 392.688 mm (V)	590.42 mm (H) x 333.72 mm (V)
Pixel Pitch	0.2727 mm (H) x 0.2727 mm (V)	0.2292 mm (H) x 0.2292 mm (V)
Maximum Pixel Clock	709.1 MHz	840.3 MHz
Model Name	S27DG60*S / S27DG61*S / S27FG60*S	S27FG50*E / S27FG60*E
Size	67.8 cm	68.4 cm
Display area	590.42 mm (H) x 333.72 mm (V)	596.736 mm (H) x 335.664 mm (V)
Pixel Pitch	0.2292 mm (H) x 0.2292 mm (V)	0.2331 mm (H) x 0.2331 mm (V)
Maximum Pixel Clock	S27DG60*S: 1670 MHz S27DG61*S: 1120 MHz S27FG60*S: 2455.25 MHz	S27FG50*E: 709.1 MHz S27FG60*E: 1418.5 MHz

Model Name	S27FG70*	S37FG75*	S40FG75*
Size	68.4 cm	92.7 cm	100.6 cm
Display area	596.736 mm (H) x 335.664 mm (V)	808.0128 mm (H) x 454.5072 mm (V)	926.8224 mm (H) x 391.0032 mm (V)
Pixel Pitch	0.1554 mm (H) x 0.1554 mm (V)	0.21042 mm (H) x 0.21042 mm (V)	0.18102 mm (H) x 0.18102 mm (V)
Maximum Pixel Clock	1711 MHz	2430 MHz	3196 MHz

Model Name	S27FG81*S	S32FG81*S	S27FG90*X
Size	67.7 cm	80.3 cm	68.4 cm
Display area	589.97 mm (H) x 332.9 mm (V)	699.48 mm (H) x 394.73 mm (V)	596.736 mm (H) x 335.664 mm (V)
Pixel Pitch	0.153 mm (H) x 0.153 mm (V)	0.1814 mm (H) x 0.1814 mm (V)	0.1554 mm (H) x 0.1554 mm (V)
Maximum Pixel Clock	2438.5 MHz	2438.5 MHz	1630 MHz

<b>Power Supply</b>	AC100-240V~ 50/60Hz Based on the AC voltage of the adapter. For the DC voltage of the product, refer to the product label.
<b>Signal connectors</b>	HDMI, DisplayPort
<b>Environmental conditions</b>	<p><b>Operating</b></p> <p>Temperature</p> <p>10 °C to 40 °C (50 °F to 104 °F): S27FG50*E / S32FG50*E / S27FG50*S / S27DG60*S / S27DG61*S / S27FG60*E / S27FG70* / S37FG75* / S40FG75* / S27FG81*S / S32FG81*S</p> <p>0 °C to 40 °C (32 °F to 104 °F): S27FG60*S / S27FG90*X</p> <p>Humidity: 10 % to 80 %, non-condensing</p> <hr/> <p><b>Storage</b></p> <p>Temperature: -20 °C to 45 °C (-4 °F to 113 °F)</p> <p>Humidity: 5 % to 95 %, non-condensing</p>

- **Plug-and-Play**  
This product can be installed and used with any Plug-and-Play compatible systems. Two-way data exchange between the product and PC system optimises the product settings. Product installation takes place automatically. However, you can customise the installation settings if desired.
- **Panel Dots (Pixels)**  
Due to the nature of the manufacturing of this product, approximately 1 pixel per million (1ppm) may be brighter or darker on the LCD panel. This does not affect product performance.
- Audio is played with the same sound settings as the connected device. Audio sound settings (e.g. the bit and sample rates) can be changed from the connected device.
- The above specifications are subject to change without notice to improve quality.
- For detailed device specifications, visit the Samsung website.
- Singapore only: S27FG502EE / S32FG502EE / S27FG502SE / S27DG602SE / S27DG610SE / S27FG602SE / S27FG602EE / S27FG702EE / S37FG752EE / S40FG752EE / S27FG812SE / S32FG812SE / S27FG900XE
- Saudi Arabia only: S27FG502EM / S32FG502EM / S27FG502SM / S27DG602SM / S27DG612SM / S27FG602SM / S27FG600EM / S27FG606EM / S27FG706EM / S37FG750EM / S40FG750EM / S27FG810SM / S32FG810SM / S27FG900XM

---

## Licences & Other Information



The terms HDMI, HDMI High-Definition Multimedia Interface, HDMI trade dress and the HDMI Logos are trademarks or registered trademarks of HDMI Licensing Administrator, Inc.



— This license may not be supported depending on the model or geographical area. Please refer to the [samsung.com](https://www.samsung.com) website for detailed information regarding FreeSync.

- Open Source License Notice  
Open Source used in this product can be found on the following webpage (<https://opensource.samsung.com>).

## Standard Signal Mode Table

Model Name		S27FG50*E / S32FG50*E / S27FG50*S	S27DG60*S	S27DG61*S
Synchronization (PANEL Spec)	Vertical Frequency	48 ~ 180 Hz	48 ~ 360 Hz	48 ~ 240 Hz
Resolution	Optimum resolution	2560 x 1440 @ 144 Hz (HDMI) 2560 x 1440 @ 180 Hz (DP)	2560 x 1440 @ 120 Hz	2560 x 1440 @ 120 Hz
	Maximum resolution	2560 x 1440 @ 144 Hz (HDMI) 2560 x 1440 @ 180 Hz (DP)	2560 x 1440 @ 360 Hz	2560 x 1440 @ 240 Hz

Model Name		S27FG60*S	S27FG60*E	S27FG81*S / S32FG81*S
Synchronization (PANEL Spec)	Vertical Frequency	48 ~ 500 Hz	48 ~ 350 Hz	48 ~ 240 Hz
Resolution	Optimum resolution	2560 x 1440 @ 500 Hz	2560 x 1440 @ 350 Hz	3840 x 2160 @ 240 Hz
	Maximum resolution	2560 x 1440 @ 500 Hz	2560 x 1440 @ 350 Hz	3840 x 2160 @ 240 Hz

Model Name		S27FG70*	S40FG75*	S27FG90*X / S37FG75*
Synchronization (PANEL Spec)	Vertical Frequency	48 ~ 360 Hz	48 ~ 180 Hz	48 ~ 165 Hz
Resolution	Optimum resolution	3840 x 2160 @ 180 Hz	5120 x 2160 @ 180 Hz	3840 x 2160 @ 165 Hz
	Maximum resolution	3840 x 2160 @ 180 Hz	5120 x 2160 @ 180 Hz	3840 x 2160 @ 165 Hz

— When using dual monitors from your computer while in DSC mode at 2560 x 1440 @ 240 Hz or higher or when using PBP mode from the computer, the computer may not function properly due to the output limit of the computer graphics card. If this happens, decrease the resolution and refresh rate from the computer.

If a signal that belongs to the following standard signal modes is transmitted from your PC, the screen will automatically be adjusted. If the signal transmitted from the PC does not belong to the standard signal modes, the screen may be blank even though the power LED turns on. In such a case, change the settings according to the following table by referring to the graphics card user manual.

Resolution	Horizontal Frequency (kHz)	Vertical Frequency (Hz)	Pixel Clock (MHz)	Sync Polarity (H/V)	Port	
					HDMI IN	DP IN
VESA, 640 x 480	31.469	59.940	25.175	-/-	0	0
VESA, 640 x 480	37.500	75.000	31.500	-/-	0	0
<sup>8)</sup> VESA, 720 x 480	29.855	59.710	26.750	-/+	0	0
VESA, 800 x 600	37.879	60.317	40.000	+/+	0	0
VESA, 800 x 600	48.077	72.188	50.000	+/+	0	0
VESA, 800 x 600	46.875	75.000	49.500	+/+	0	0
VESA, 1024 x 768	48.363	60.004	65.000	-/-	0	0
VESA, 1024 x 768	56.476	70.069	75.000	-/-	0	0
VESA, 1024 x 768	60.023	75.029	78.750	+/+	0	0
VESA, 1152 x 864	67.500	75.000	108.000	+/+	0	0
VESA, 1280 x 720	45.000	60.000	74.250	+/+	0	0
VESA, 1280 x 800	49.702	59.810	83.500	-/+	0	0
VESA, 1280 x 1024	63.981	60.020	108.000	+/+	0	0
VESA, 1280 x 1024	79.976	75.025	135.000	+/+	0	0
VESA, 1440 x 900	55.935	59.887	106.500	-/+	0	0
VESA, 1600 x 900	60.000	60.000	108.000	+/+	0	0
VESA, 1680 x 1050	65.290	59.954	146.250	-/+	0	0
VESA, 1920 x 1080	67.500	60.000	148.500	+/+	0	0
<sup>10)11)</sup> VESA, 1920 x 1080RB	166.587	143.981	346.500	+/-	0	-
<sup>8)10)11)</sup> VESA, 2560 x 1440RB	88.787	59.951	241.500	+/-	0	0
<sup>8)10)11)</sup> VESA, 2560 x 1440RB	182.996	119.998	497.750	-/+	0	0

Resolution	Horizontal Frequency (kHz)	Vertical Frequency (Hz)	Pixel Clock (MHz)	Sync Polarity (H/V)	Port	
					HDMI IN	DP IN
<sup>8)</sup> VESA, 3840 x 2160RB	133.313	59.997	533.250	+/-	0	0
<sup>9)</sup> CEA, 720 x 480	31.469	59.940	27.000	-/-	0	0
<sup>8)</sup> CEA, 1920 x 1080	67.500	60.000	148.500	+/+	0	0
<sup>7)</sup> CEA, 1280 x 720	45.000	60.000	74.250	+/+	0	0
<sup>7)</sup> CEA, 1920 x 1080	67.500	60.000	148.500	+/+	0	0
CEA, 1920 x 1080	135.000	120.000	297.000	+/+	0	0
<sup>5)</sup> CEA, 2560 x 1080	66.000	60.000	198.000	+/+	0	0
<sup>5)</sup> CEA, 2560 x 1080	150.000	120.000	495.000	+/+	0	0
<sup>8)</sup> CEA, 3840 x 2160	67.500	30.000	297.000	+/+	0	0
<sup>7)</sup> CEA, 3840 x 2160	67.500	30.000	297.000	+/+	0	-
CEA, 3840 x 2160	135.000	60.000	594.000	+/+	0	-
<sup>8)</sup> CEA, 3840 x 2160	270.000	120.000	1188.000	+/+	0	0
<sup>5)</sup> CEA, 5120 x 2160	135.000	60.000	742.500	+/+	0	0
<sup>5)</sup> CEA, 5120 x 2160	270.000	120.000	1485.000	+/+	0	0
<sup>9)</sup> Custom Timing, 2560 x 1440	96.479	59.999	277.860	+/-	0	0
<sup>9)</sup> Custom Timing, 2560 x 1440	192.958	119.999	555.720	+/-	0	0
<sup>3) 4)</sup> Custom Timing, 2560 x 1440	257.169	164.958	699.500	+/-	0	0
<sup>10) 11)</sup> Custom Timing, 2560 x 1440	266.509	180.000	706.250	+/-	-	0
<sup>11)</sup> Custom Timing, 2560 x 1440	244.340	164.983	647.500	+/-	-	0
<sup>11)</sup> Custom Timing, 2560 x 1440	213.265	144.000	580.080	+/-	0	-
<sup>7)</sup> Custom Timing, 2560 x 1440	357.592	239.994	1052.750	+/-	0	0
<sup>1)</sup> Custom Timing, 2560 x 1440	385.851	239.957	1111.250	+/-	0	0
<sup>1)</sup> Custom Timing, 2560 x 1440	578.878	359.999	1667.170	+/-	0	0

Resolution	Horizontal Frequency (kHz)	Vertical Frequency (Hz)	Pixel Clock (MHz)	Sync Polarity (H/V)	Port	
					HDMI IN	DP IN
<sup>2)</sup> Custom Timing, 2560 x 1440	385.545	239.767	1116.539	+/-	0	0
<sup>6)</sup> Custom Timing, 2560 x 1440	833.984	499.991	2455.250	+/-	0	-
<sup>6)</sup> Custom Timing, 2560 x 1440	833.984	499.991	2268.250	+/-	-	0
<sup>6)</sup> Custom Timing, 2560 x 1440	400.306	239.991	1178.500	+/-	0	0
<sup>7)</sup> Custom Timing, 2560 x 1440	521.484	349.990	1535.250	+/-	0	0
<sup>5)</sup> Custom Timing, 2560 x 1080	204.228	180.000	555.500	+/-	0	0
<sup>5)</sup> Custom Timing, 2560 x 1440	272.335	180.000	740.750	+/-	0	0
<sup>8)</sup> Custom Timing, 2560 x 1440	269.956	179.971	794.750	+/-	0	0
<sup>5)</sup> Custom Timing, 3440 x 1440	183.000	119.991	658.750	+/-	0	0
<sup>5)</sup> Custom Timing, 3440 x 1440	272.292	180.000	980.250	+/-	0	0
<sup>4)</sup> Custom Timing, 3840 x 2160	385.750	165.000	1543.000	+/-	0	0
<sup>5)</sup> Custom Timing, 3840 x 2160	408.600	180.000	1725.750	+/+	0	0
<sup>8)</sup> Custom Timing, 3840 x 2160	404.948	179.977	1710.500	+/-	0	0
<sup>5)</sup> Custom Timing, 5120 x 2160	408.566	180.000	2248.750	+/-	0	0
Custom Timing, 1920 x 1080	96.479	59.999	277.860	+/-	0	0
Custom Timing, 1920 x 1080	289.352	239.927	625.000	+/-	0	0
<sup>3) 4) 11)</sup> Custom Timing, 1920 x 1080	192.788	164.917	401.000	+/-	0	0
<sup>10) 11)</sup> Custom Timing, 1920 x 1080	199.876	180.000	401.750	+/-	-	0
<sup>11)</sup> Custom Timing, 1920 x 1080	166.587	143.981	346.500	+/-	0	-
<sup>1)</sup> Custom Timing, 1920 x 1080	434.144	359.986	937.750	+/-	0	0
<sup>7)</sup> Custom Timing, 1920 x 1080	268.269	239.955	558.000	+/-	0	0
<sup>7)</sup> Custom Timing, 1920 x 1080	391.276	349.979	901.500	+/-	0	0
<sup>5)</sup> Custom Timing, 1920 x 1080	204.207	180.000	424.750	+/-	0	0

Resolution	Horizontal Frequency (kHz)	Vertical Frequency (Hz)	Pixel Clock (MHz)	Sync Polarity (H/V)	Port	
					HDMI IN	DP IN
<sup>8)</sup> Custom Timing, 1920 x 1080	65.647	59.951	151.250	+/-	0	0
<sup>8)</sup> Custom Timing, 1920 x 1080	202.474	179.977	466.500	+/-	0	0
<sup>8)</sup> Custom Timing, 1920 x 1080	269.952	239.957	561.500	+/-	0	0
<sup>8)</sup> Custom Timing, 1920 x 1080	404.948	359.954	933.000	+/-	0	0
<sup>6)</sup> Custom Timing, 1920 x 1080	625.434	499.947	1441.000	+/-	0	0
<sup>6)</sup> Custom Timing, 1920 x 1080	300.239	239.999	691.750	+/-	0	0

— <sup>1)</sup> This input signal is supported on S27DG60\*S.

— <sup>2)</sup> This input signal is supported on S27DG61\*S.

— <sup>3)</sup> This input signal is supported on S27FG90\*X.

— <sup>4)</sup> This input signal is supported on S37FG75\*.

— <sup>5)</sup> This input signal is supported on S40FG75\*.

— <sup>6)</sup> This input signal is supported on S27FG60\*S.

— <sup>7)</sup> This input signal is supported on S27FG60\*E.

— <sup>8)</sup> This input signal is supported on S27FG70\*.

— <sup>9)</sup> S27FG70\* models are not supported.

— <sup>10)</sup> This input signal is supported on S27FG50\*S.

— <sup>11)</sup> This input signal is supported on S27FG50\*E/S32FG50\*E.

#### — Horizontal Frequency

The time required to scan a single line from the left to the right side of the screen is called a horizontal cycle. The reciprocal number of a horizontal cycle is called horizontal frequency. Horizontal frequency is measured in kHz.

#### — Vertical Frequency

Repeating the same picture dozens of times per second allows you to view natural pictures. The repeat frequency is called "vertical frequency" or "refresh rate" and is indicated in Hz.

— This product can be set to only one resolution for each screen size to obtain the optimum picture quality due to the nature of the panel. Using a resolution other than the specified resolution may degrade the picture quality. To avoid this, it is recommended that you select the optimum resolution specified for your product.

— Depending on the source device, 4K output from an AV device is supported only when the **Adaptive-Sync** is **Off**.

---

## List of graphic cards supporting HDR10

HDR10 is accessible only on Windows 10 systems equipped with graphic cards that support Play Ready 3.0 Digital Rights Management (for protected HDR content). Use graphic cards listed below for HDR10.

- NVIDIA GeForce 1000 series or higher
- AMD Radeon™ RX 400 series or higher
- Intel UHD Graphics 600 series or higher

— Graphic cards that support hardware-accelerated 10-bit video decoding for HDR video codecs are recommended.

# Appendix

## Responsibility for the Pay Service (Cost to Customers)

— When the service is requested, in spite of in warranty, we may charge you for a visit from a service technician in the following cases.

### Not a product defect

Cleaning of the product, Adjustment, Explanation, Re-installation and etc.

- If a service technician is requested to give instructions on how to use product or simply adjusts options without disassembling product.
- If a defect is caused by external environmental factors (Internet, Antenna, Wired Signal, etc.)
- If a product is reinstalled or devices are connected additionally after installing the purchased product for the first time.
- If a product is reinstalled to move to a different spot or to move to a different house.
- If the customer requests instructions on how to use another company's product.
- If customer requests instructions on how to use the network or another company's programme.
- If customer requests software installation and setup for the product.
- If a service technician removes/cleans dusts or foreign materials inside of the product.
- If customer requests an installation additionally after purchasing a product through home-shopping or online.

## A Product damage caused by customer's fault

Product damage caused by customer's mishandling or wrong repair

If a product damage is caused by;

- External impact or drop.
- Use of supplies or separately sold product unspecified by Samsung.
- Repair from a person besides an engineer of outsourcing service company or partner of Samsung Electronics Co., Ltd.
- Remodeling or repairing the product by customer.
- Using it with incorrect voltage or non-authorized electrical connections.
- Not following the "cautions" in User guide.

### Others

- If product fails by natural disaster. (lightning, fire, earthquake, flood damage, etc)
- If consumable components are all used up. (Battery, Toner, Fluorescent lights, Head, Vibrator, Lamp, Filter, Ribbon, etc.)

— If customer requests a service in case the product has no defect, service fee may be charged. So please read User guide first.

---

## FreeSync (for AMD graphics card)

— This function may not be supported depending on the model.

FreeSync technology is solution that eliminates screen tearing without all the usual lag and latency.

This feature will eliminate screen tearing and lag during game play. Improve your gaming experience.

The displayed FreeSync menu items on the monitor may vary, depending on the monitor model and compatibility with the AMD graphics card.

- **Off:** Disable FreeSync.
- **On:** Turn on the AMD graphics cards' FreeSync function. You may experience intermittent flickers when playing some games.

Apply the optimum resolution when using FreeSync.

The refresh rate setting method please refer to Q & A → How can I change the frequency?

— This menu is not available when **PC/AV Mode** is set to **AV**.

— This menu is not available when **PIP Mode** (or **PIP/PBP Mode**) is enabled.

— The FreeSync function is only enabled in **HDMI** or **DisplayPort** mode.  
Use the HDMI/DP cable provided by the manufacturer when using FreeSync.

— If the FreeSync function is in use and the text displayed on the PC screen looks blurry or corrupted, resolve the issue by changing the resolution of the PC screen to the recommended resolution.

— If the **DisplayPort Ver.** is set to **1.1**, the **FreeSync / FreeSync Premium / FreeSync Premium Pro** mode is disabled.

— If the **DisplayPort Ver.** is set to **1.2**, the **FreeSync / FreeSync Premium / FreeSync Premium Pro** mode is disabled.

If you use the FreeSync function while playing a game, the following symptoms may occur:

- The screen may flicker depending on the type of graphics card, the game option settings, or the video being played. Try the following actions: decrease the game setting values, change the current **FreeSync / FreeSync Premium / FreeSync Premium Pro** mode to **Off**, or visit the AMD website to check your graphics driver's version and update it with the latest one.

- 
- While you are using the FreeSync function, the screen may flicker due to variation of the output frequency from the graphics card.
  - The response rate during the game may fluctuate depending on the resolution. A higher resolution generally decreases the response rate.
  - The sound quality of the monitor may be degraded.

— If you encounter any issues when using the function, contact the Samsung Service Centre.

— If you change the screen resolution while the function is **On**, the screen may intermittently blank out due to the graphic card. Set **FreeSync / FreeSync Premium / FreeSync Premium Pro** to **Off** and change the resolution.

— The function is unavailable in the devices (e.g. AV devices) that have no AMD graphic card. If the function is applied, the screen may have malfunction.

### The models in the Graphics Cards list supports FreeSync

FreeSync can only be used with specific AMD graphics card models. Refer to the following list for supported graphics cards:

Make sure to install the latest official graphics drivers from AMD that support FreeSync.

— For additional AMD graphics card models that support the FreeSync feature, visit the official AMD website.

— Select **FreeSync / FreeSync Premium / FreeSync Premium Pro Off** if you are using a graphics card from a different manufacturer.

— When applying the FreeSync function via the HDMI cable, it may fail to work due to the bandwidth limitation of certain AMD graphics card.

- Radeon™ RX Vega series
- Radeon™ RX 500 series
- Radeon™ RX 400 series
- Radeon™ R9/R7 300 series (excluding R9 370/X, R7 370/X, R7 265)
- Radeon™ Pro Duo (2016 edition)
- Radeon™ R9 Nano series
- Radeon™ R9 Fury series
- Radeon™ R9/R7 200 series (excluding R9 270/X, R9 280/X)

---

## Adaptive-Sync (for NVIDIA graphics card)

— This function may not be supported depending on the model.

**Adaptive-Sync** technology is a solution that eliminates screen tearing without all the usual lag and latency.

This feature will eliminate screen tearing and lag during game play. Improve your gaming experience.

The displayed **Adaptive-Sync** menu items on the product may vary, depending on the product model and compatibility with the NVIDIA graphics card.

- **Off:** Disable **Adaptive-Sync**.
- **On:** Enable the **Adaptive-Sync** feature with a higher screen frame rate. Screen tearing (abnormal sync between the screen and content) is reduced in this mode. Note, however, that intermittent screen flickering may occur during gameplay.

If you use the **Adaptive-Sync** function while playing a game, the following symptoms may occur:

- The screen may flicker depending on the type of graphics card, the game option settings, or the video being played. Try the following actions: decrease the game setting values, or visit the NVIDIA website to check your graphics driver's version and update it with the latest one.
- When using the **Adaptive-Sync** function, the screen may flicker due to the fluctuation of output frequency from the graphics card.
- The response rate during the game may fluctuate depending on the resolution. A higher resolution generally decreases the response rate.
- The sound quality of the product may be degraded.

— If you encounter any issues when using the function, contact the Samsung Service Centre.

— When the resolution is changed while setting **Adaptive-Sync**, the screen tearing can happen intermittently. Set **Adaptive-Sync** to **Off** and change the resolution.

— The function is unavailable in the devices (e.g. AV devices) that have no NVIDIA graphics card. If the function is applied, the screen may malfunction.

— Depending on the source device, 4K output from an AV device is supported only when the **Adaptive-Sync** is **Off**.

— Use the DisplayPort cable provided by the manufacturer when using **Adaptive-Sync**.

— Install the latest NVIDIA graphics card driver to enable **Adaptive-Sync**.

— Use Windows 10 or higher to enable **Adaptive-Sync**.

— If the **Adaptive-Sync** function is in use and the text displayed on the PC screen looks blurry or corrupted, resolve the issue by changing the resolution of the PC screen to the recommended resolution.

— If the **DisplayPort Ver.** is set to **1.1**, the **Adaptive-Sync** mode is disabled.

— If you set the **HDMI Mode** to **1.4**, the **Adaptive-Sync** mode is disabled.

### The models in the Graphics Cards list supports Adaptive-Sync

**Adaptive-Sync** can only be used with specific NVIDIA graphics card models. Refer to the following list for supported graphics cards:

Make sure to install the latest official graphics drivers from NVIDIA that support **Adaptive-Sync**.

— For additional NVIDIA graphics card models that support the **Adaptive-Sync** feature, visit the official NVIDIA website.

— Select **Adaptive-Sync Off** if you are using a graphics card from a different manufacturer.

— When applying the **Adaptive-Sync** function through the DisplayPort cable, it may fail to work due to the bandwidth limitation of certain NVIDIA graphics cards.

- GeForce GTX 10 series
- GeForce RTX 20 series
- GeForce RTX 30 series
- GeForce RTX 40 series