

**SAMSUNG**

# USER MANUAL

SM-R400N

English. 09/2023. Rev.1.0

[www.samsung.com](http://www.samsung.com)

# Table of Contents

## Getting started

- 3 About the Galaxy Buds FE
- 4 Device layout and functions
- 6 Preparing the earbuds for use
- 8 Charging the battery
- 12 Battery indicator lights identification

## Using the earbuds

- 14 Connecting the earbuds to a mobile device
- 18 Wearing the earbuds
- 20 Using the earbud by touch
- 23 Using the noise controls mode
- 24 Listening to music
- 25 Using the equaliser
- 26 Using call features
- 27 Bixby

## Galaxy Wearable app

- 29 Introduction
- 30 Connecting and disconnecting the earbuds
- 31 Configuring settings for the Galaxy Buds FE

## Usage notices

- 37 Precautions for using the device
- 38 Notes on package contents and accessories
- 39 Precautions for using the earbuds
- 40 Cleaning and managing the Galaxy Buds FE
- 41 Restarting the earbuds
- 42 Coupling the earbuds

## Appendix

- 43 Troubleshooting
- 47 Removing the battery

# Getting started

## About the Galaxy Buds FE

Galaxy Buds FE are wireless earbuds which allow you to listen to music or answer incoming calls after connecting them to your mobile device even while doing other activities, such as working out.

 Do not wear the earbuds in high-traffic areas, such as roads or crosswalks. Doing so may result in accidents because of slowed reaction times.

# Device layout and functions

## Earbud

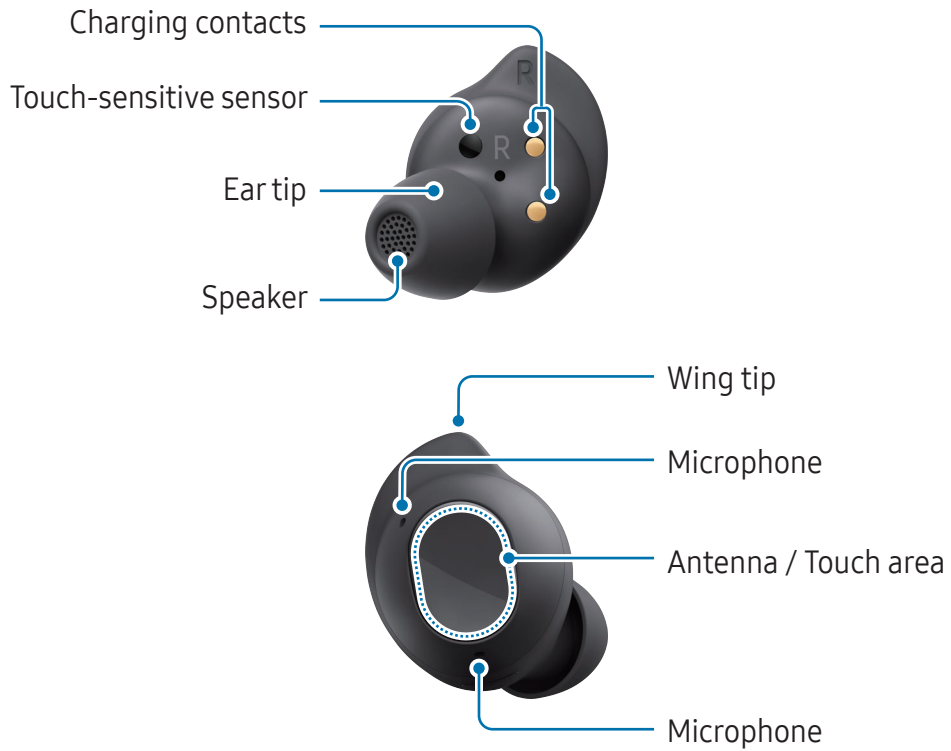

## Wing tip

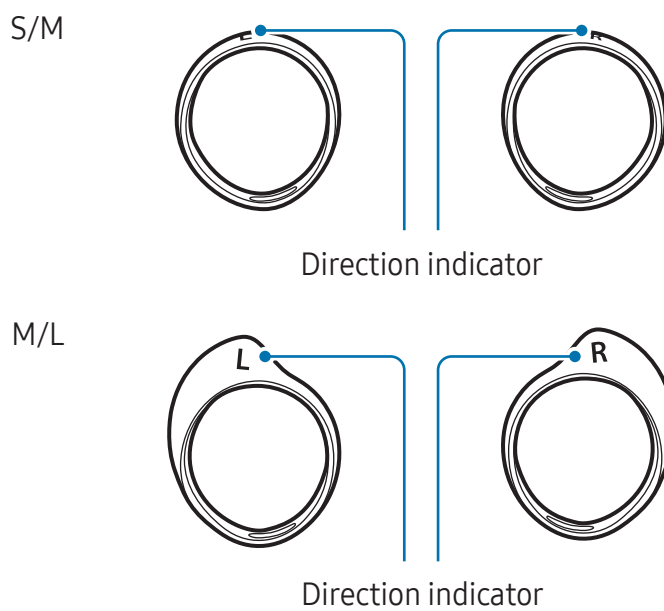

## Charging case

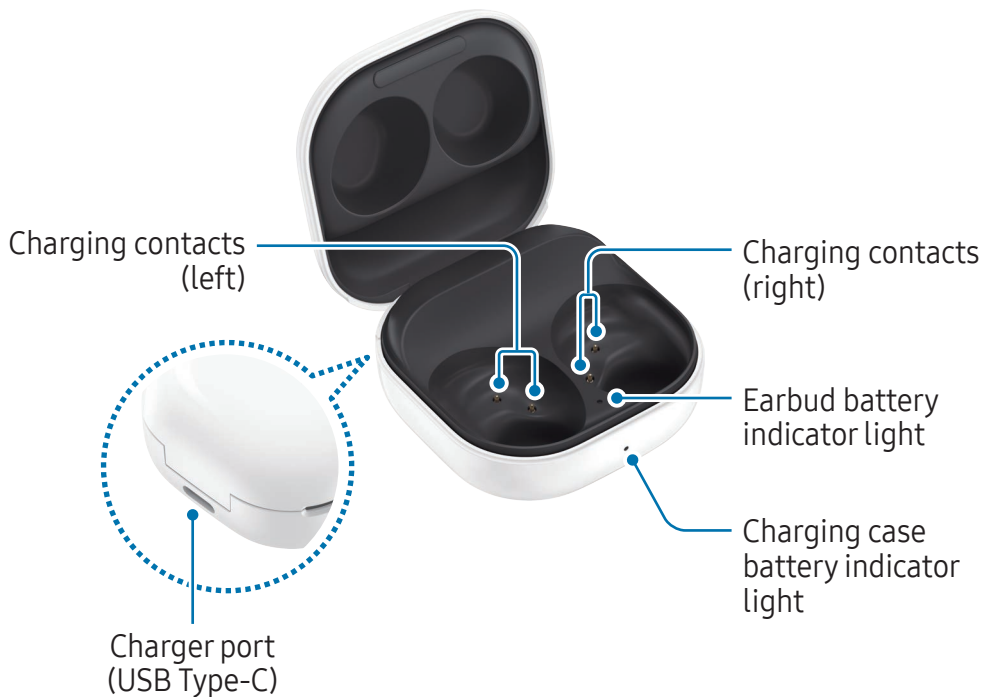

- ⚠️ Use the device in a place without magnetic interference for the device to operate normally.
  - Your device and some accessories (sold separately) contain magnets. Keep it away from credit cards, implanted medical devices, and other devices that may be affected by magnets. In the case of medical devices, keep your device more than 15 cm apart. Stop using your device if you suspect any interference with your medical device and consult your physician or your medical device manufacturer.
  - If you have a medical implant in your heart, do not place your device in a pocket close to your implanted device, such as your chest or inner jacket pocket.
  - Keep a safe distance between objects that are affected by magnets, and your device and some accessories (sold separately) that contain magnets. Objects such as credit cards, passbooks, access cards, boarding passes, or parking passes may be damaged or disabled by the magnets in the device.
- ⚠️ If you use the earbuds when they are broken, there may be a risk of injury. Use the earbuds only after they have been repaired at a Samsung Service Centre or an authorised service centre.

- If foreign materials are placed on the touch-sensitive sensor, they may cause the sensor to malfunction. Before wearing the earbuds, clean the sensor first.
- If there is sweat or liquid on the charging contacts, corrosion may occur on the Galaxy Buds FE. When there is sweat or liquid on the charging contacts or earbuds, clean them before inserting the earbuds in the charging case.
- Prevent water from coming into contact with the touch area. The touch feature may malfunction in humid conditions or when exposed to water.

## Preparing the earbuds for use

### Attaching an ear tip to the earbud

- Do not put the earbuds in your ears without ear tips. Doing so may hurt your ears.
- Do not pull the ear tip excessively when you attach or detach it. The ear tip may tear.
- Do not press the ear tip excessively or twist it. The ear tip may be damaged.

- 1 Select the ear tip that fits your ear.
- 2 Align the latch at the bottom of the earbud and groove of the ear tip and cover the latch with the ear tip.

- Push the ear tip all the way in so that it does not come out.

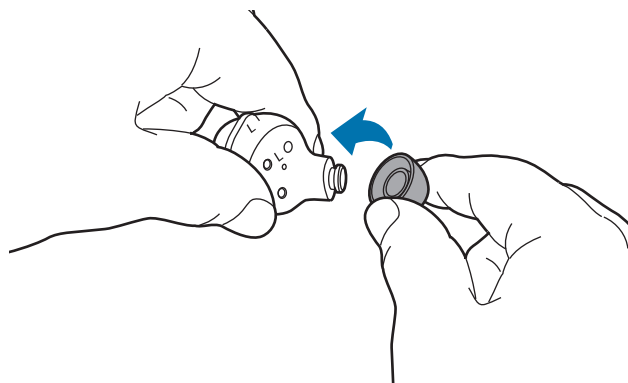

- 3 Follow the same procedure for the opposite earbud.

## Attaching a wing tip to the earbud

- 1 Select the wing tip that fits your ear.
- 2 Select the wing tip for the left or right ear.
- 3 Hook the wing tip's groove to earbud's fixation hook and cover the earbud with the wing tip.

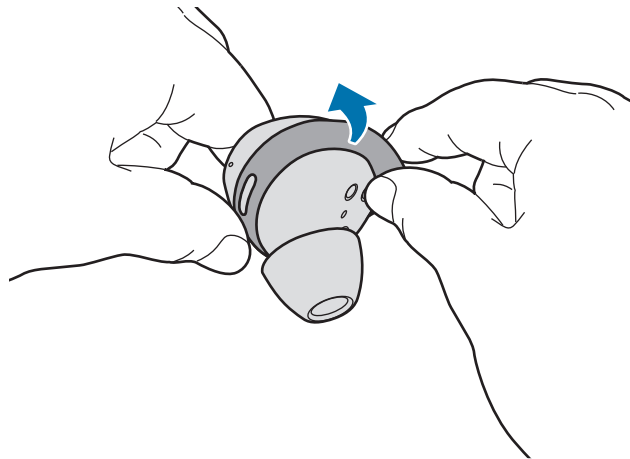

- ❗ Do not put the earbuds in your ears without wing tips. Doing so may hurt your ears.
- Do not pull the wing tip excessively when you attach or detach it. The wing tip may tear.
- ✍ Do not put the wing tips on the earbuds in the wrong direction. The earbuds will not fit in your ears properly.
- Check the left and right imprinted direction marks on the wing tips and earbuds, and check if the wing tips are inserted as shown in the image.

S/M

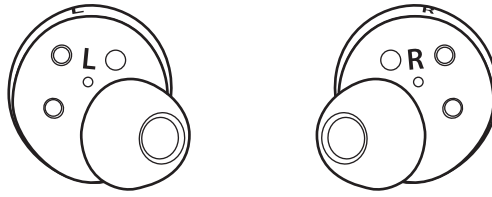

M/L

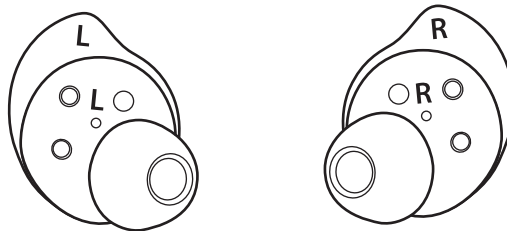

4 Follow the same procedure for the opposite earbud.

## Charging the battery

Fully charge the battery before using the earbuds for the first time or when they have been unused for extended periods. The earbuds will start to work while charging. When you charge the battery for the first time or when the battery is completely discharged, it needs at least 10 minutes to start to work.

The charging case, which has a built-in battery, is charged along with the earbuds that are in the charging case when connected to the charger.

 If you put the earbuds in a completely discharged charging case, they may emit a sound. Sufficiently charge the charging case before inserting the earbuds.

1 Open the charging case.



- 2 Check the direction of each earbud and correctly insert them into their corresponding slots in the charging case.

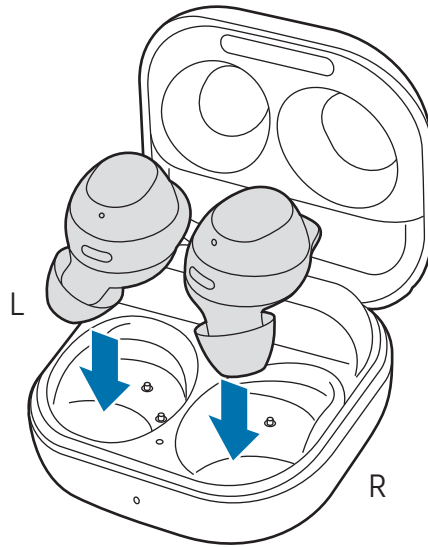

- 3 Close the charging case.

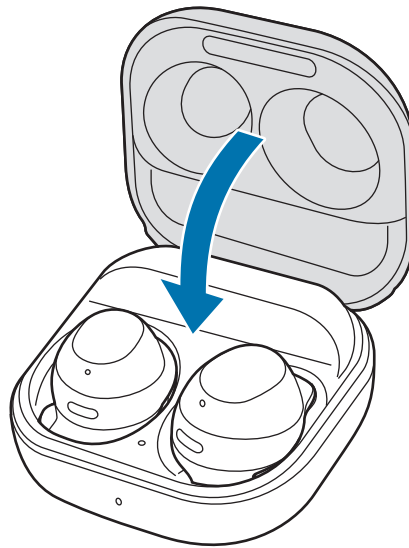

- 4 Connect the USB cable to the charger and then plug the USB cable into the charger port.

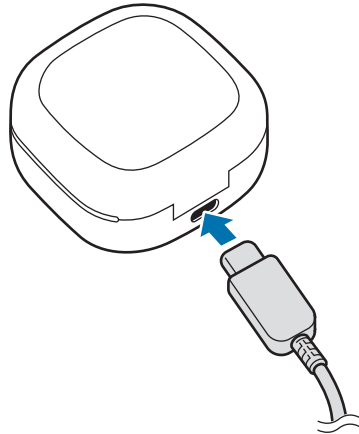

- 5 Plug the charger into an electric socket. The batteries of the earbuds and the charging case are charged simultaneously.
- 6 After fully charging, disconnect the charging case from the charger. First disconnect the USB cable from the charging case and then unplug the charger from the electric socket.

## Checking the battery level

Connect the earbuds to your mobile device, open the **Galaxy Wearable** app on your mobile device, and check the battery status of the earbuds and the charging case. Refer to [Connecting the earbuds to a mobile device](#) for more information.

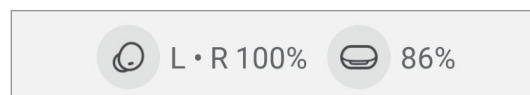



- When the remaining battery level is low, a notification will appear on your mobile device's notification panel.

## Reducing the battery consumption

When you are not using the earbuds, store them in a charging case that has been charged. If not, the touch-sensitive sensor will continue to work, and it will affect to the usage time and battery consumption.

## Battery charging tips and precautions

-  Use only Samsung-approved charger and cable specifically designed for your Galaxy Buds FE. Incompatible charger and cable can cause serious injuries or damage to your device.
- 
  - Connecting the charger improperly may cause serious damage to the charging case. Any damage caused by misuse is not covered by the warranty.
  - Use only USB Type-C cable supplied with the Galaxy Buds FE. The charging case may be damaged if you use Micro USB cable.
  - If you charge the Galaxy Buds FE while the charger port is wet, the Galaxy Buds FE may be damaged. Thoroughly dry the charger port before charging the Galaxy Buds FE.
- 
  - Chargers are sold separately.
  - To save energy, unplug the charger when not in use. The charger does not have a power switch, so you must unplug the charger from the electric socket when not in use to avoid wasting power.
  - When using a charger, it is recommended to use an approved charger that guarantees the charging performance.
  - Keep the charging case closed while you store or charge the earbuds, or when you charge the charging case.
  - If you touch the charging contacts while charging the charging case, it may affect charging.
  - If there is sweat or liquid on the charging contacts, corrosion may occur on the Galaxy Buds FE. When there is sweat or liquid on the charging contacts or earbuds, clean them before inserting the earbuds in the charging case.
  - When you insert your earbuds in the charging case, the charging will start automatically, and it will stop automatically if earbuds are fully charged.
  - It will likely not have a huge impact on the life of your Galaxy Buds FE even if you do not remove your earbuds from the charging case after the earbuds are fully charged.
  - If you will not be using your Galaxy Buds FE for a long time, store them after they are charged.
  - Do not put the wing tips on the earbuds in the wrong direction. The earbuds will not be charged if they are not properly inserted into the charging case.



- Using a power source other than the charger, such as a computer, may result in a slower charging speed because of a lower electric current.
- While charging, the Galaxy Buds FE and the charger may heat up. This is normal and should not affect the Galaxy Buds FE lifespan or performance. If the battery gets hotter than usual, the charger may stop charging.
- If the Galaxy Buds FE are not charging properly, take the Galaxy Buds FE and the charger to a Samsung Service Centre or an authorised service centre.
- Avoid bending the USB cable. Doing so may damage or reduce the lifespan of the USB cable. Never use a damaged USB cable.

## Battery indicator lights identification

The battery indicator lights inform you of your earbuds and the charging case's charging status.

The earbud battery indicator light is located inside of the charging case and shows the charging status of the earbuds. The charging case battery indicator light on the front of the charging case indicates the charging status of the case itself.

### Earbud battery indicator light

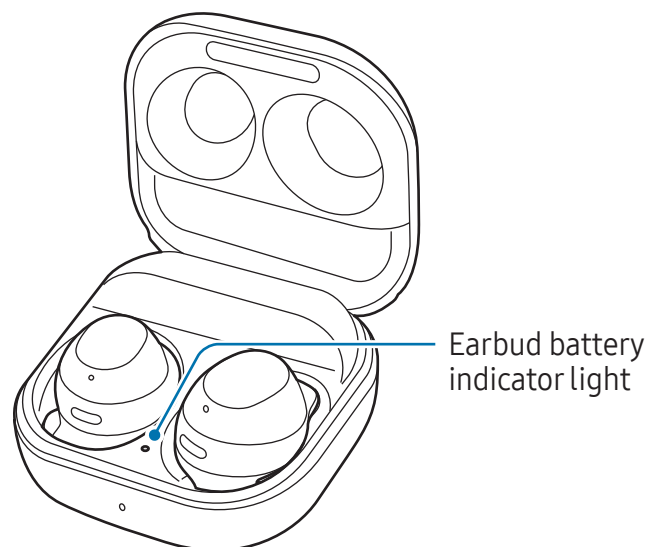

Colour	Status
Continuously red	• Charging
Continuously green	• Fully charged
Flashes red	• Charging blocked because of abnormal temperatures

## Charging case battery indicator light

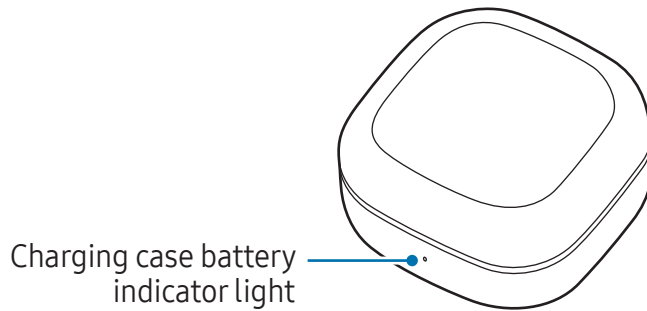

Colour	Status
Continuously red	<ul style="list-style-type: none"> <li>• Charging</li> </ul>
Continuously green	<ul style="list-style-type: none"> <li>• Fully charged</li> </ul>
Flashes red	<ul style="list-style-type: none"> <li>• Charging blocked because of abnormal temperatures</li> </ul>
Flashes red (flashes after closing the charging case)	<ul style="list-style-type: none"> <li>• Battery power is low (lower than 10%)</li> </ul>
Red (stays on for 5 seconds after closing the charging case)	<ul style="list-style-type: none"> <li>• Battery power is low (between 10% and 29%)</li> </ul>
Yellow (stays on for 5 seconds after closing the charging case)	<ul style="list-style-type: none"> <li>• Battery power is moderate (between 30% and 59%)</li> </ul>
Green (stays on for 5 seconds after closing the charging case)	<ul style="list-style-type: none"> <li>• Battery power is high (more than 60%)</li> </ul>

-  If the battery indicator lights do not work as described, disconnect the charger from the charging case and reconnect it.

# Using the earbuds

## Connecting the earbuds to a mobile device

### Before the connection

- Charge the charging case sufficiently.
- The Galaxy Wearable app must be installed on your mobile device. If the app is not installed on your mobile device, download the app from **Galaxy Store** or **Play Store**.
  -  • You can download the Galaxy Wearable app only on mobile devices running Android OS version 8.0 (API 26), or later, and with 1.5 GB of memory or more.
  - You can change the language of the Galaxy Wearable app on your mobile device. Open **Settings** on your mobile device and tap **General management** → **Language**. English may appear by default if the selected language on Settings is not supported on the Galaxy Wearable app.

### Connecting the earbuds to a Samsung mobile device for the first time

- 1 Check the direction of each earbud and correctly insert them into their corresponding slots in the charging case.

If the earbud battery indicator light does not flash, connect the charging case to the charger and charge them for more than 10 minutes.
- 2 Close the charging case.
- 3 Open the charging case.

The earbuds will enter Bluetooth pairing mode automatically and a pop-up window will appear on your mobile device.

If the pop-up window does not appear or if you want to connect to a non-Samsung mobile device that also uses the Android OS, refer to [Connecting the earbuds to a non-Samsung mobile device that also uses the Android OS \(or, the connection pop-up window does not appear\)](#).

- When the charging case battery indicator light flashes in red, take out the earbuds from the charging case and insert them into the case again.

4 On your mobile device, tap **Connect** on the pop-up window and follow the on-screen instructions to complete the connection.

Once the connection has been established, the earbuds will be automatically connected to your mobile device whenever you open the charging case while the earbuds are inside it.

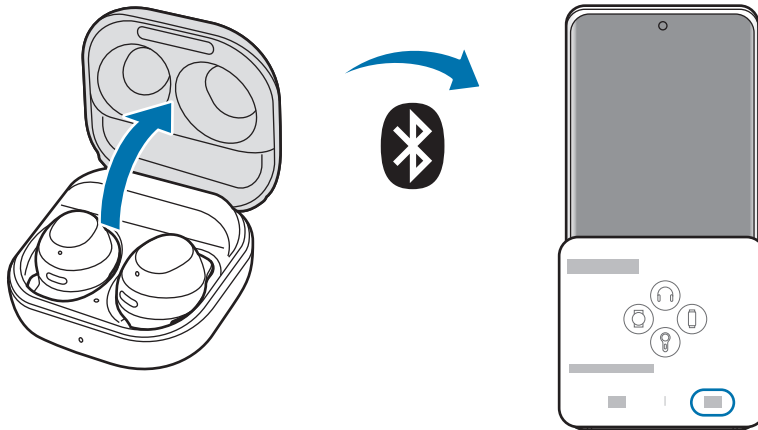

- You can download the Galaxy Wearable app only on mobile devices running Android OS version 8.0 (API 26), or later, and with 1.5 GB of memory or more.
- Connection methods may vary depending on your mobile device and software version.
- The connection pop-up window will appear only on Samsung mobile devices running Android OS version 9.0 or later that have the SmartThings app installed. If the pop-up window does not appear, update the SmartThings app to the latest version.
- The appearance of the pop-up window may vary depending on your connected mobile device.
- If the earbuds do not connect to a mobile device within 3 minutes, Bluetooth pairing mode will be turned off. Close the charging case again and open it. The earbuds will enter Bluetooth pairing mode.
- If you want to connect to another mobile device after a connection has been established, refer to [Connecting with other devices after disconnecting from the previous mobile device](#).



- When connecting earbuds with a mobile device that has been signed in to a Samsung account, the earbuds pairing information will be synced on the other mobile devices that use the same Samsung account and you do not need to pair them at the beginning again. To connect the other devices that use the same Samsung account with the earbuds, on the mobile devices that you want to connect, open **Settings**, tap **Connections** → **Bluetooth**, and then select the earbuds synced through the Samsung account.
- If only a single earbud is connected to your mobile device, you will hear the sound in mono. It will automatically switch to stereo mode when both earbuds are connected to your mobile device.
- If the earbuds do not connect to a mobile device, the connection pop-up window does not appear, or your mobile device cannot find the earbuds, store them in the charging case and touch and hold both earbuds for more than 3 seconds to enter Bluetooth pairing mode manually. When Bluetooth pairing mode has been entered, the earbud battery indicator light will flash red and green.

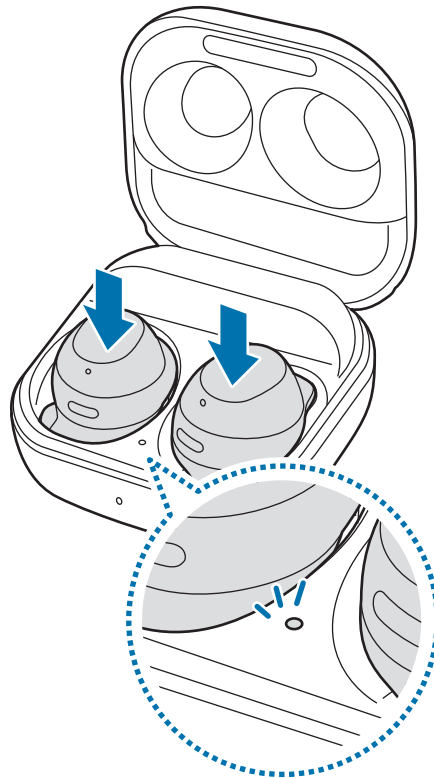



## Connecting the earbuds to a non-Samsung mobile device that also uses the Android OS (or, the connection pop-up window does not appear)



If you connect to a non-Samsung mobile device that also uses the Android OS, some of the features of the earbuds may not be available and the earbuds may not work properly.

- 1 Check the direction of each earbud and correctly insert them into their corresponding slots in the charging case.  
If the earbud battery indicator light does not flash, connect the charging case to the charger and charge them for more than 10 minutes.
- 2 Close the charging case.
- 3 Open the charging case.  
The earbuds will enter Bluetooth pairing mode automatically.
- 4 On your mobile device, turn on the Bluetooth feature to connect the earbuds to your mobile device, open the **Galaxy Wearable** app, and then follow the on-screen instructions to complete the connection.



### Precautions for using Bluetooth

- To avoid problems when connecting your earbuds to another device, place the devices close to each other.
- Ensure that your earbuds and the other Bluetooth device are within the maximum Bluetooth connection range (10 m). The distance may vary depending on the environment the devices are used in.
- Ensure that there are no obstacles between the earbuds and a connected device, including human bodies, walls, corners, or fences.
- Do not touch the Bluetooth antenna of a connected device.
- Bluetooth uses the same frequency as some industrial, scientific, medical, and low power products and interference may occur when making connections near these types of products.
- Some devices, especially those that are not tested or approved by the Bluetooth SIG, may be incompatible with the earbuds.
- Do not use the Bluetooth feature for illegal purposes (for example, pirating copies of files or illegally tapping communications for commercial purposes).

## Wearing the earbuds

Insert the wing tips into your ears and adjust them accordingly to fit your ears.

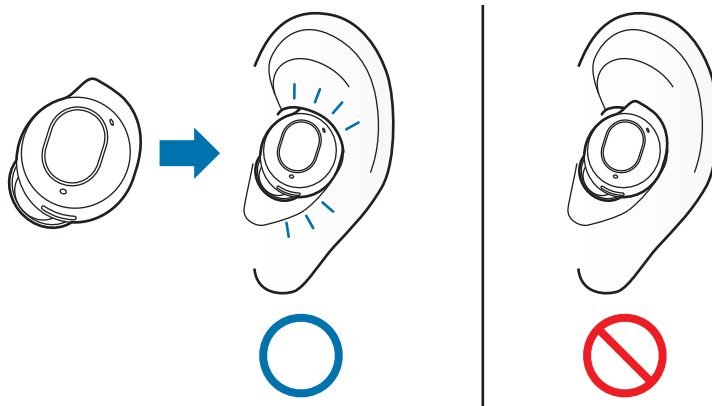

- If the touch-sensitive sensor does not make contact with your ear, the earbud may not work. Use the ear tips that fit your ears if you do not hear a sound informing you that the earbud is detected.
- If the earbuds are not positioned correctly in your ears, features like calling through the earbuds may not work. Use a pair of ear tips that fit your ears and wear the earbuds properly.
- Follow all posted warnings and directions from authorised personnel in areas where the use of wireless devices is restricted, such as aeroplanes and hospitals.

- 1 Hold the upper and lower sides of each earbud and remove them from the charging case.

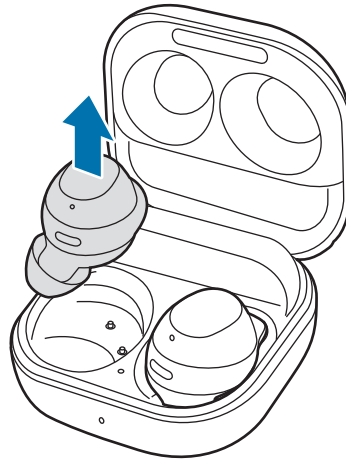

- 2 Check the direction of each earbud.
- 3 Hold the earbuds with the wing tips facing upwards so that the imprinted direction marks are exposed, and insert the earbuds into your ears until they fit to your pinnas.
- 4 Adjust the earbuds by rotating them to the left and right so that they fit comfortably in your ears.

The touch-sensitive sensors will detect that you are wearing the earbuds when you put them on. Then, the earbud will emit a sound informing you that the earbud is detected.

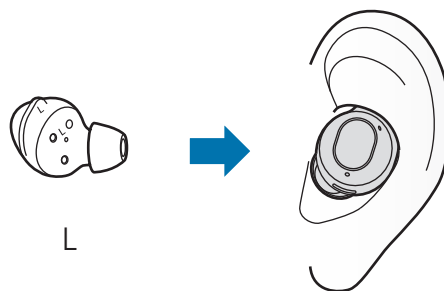



## Using the earbud by touch

### Introduction

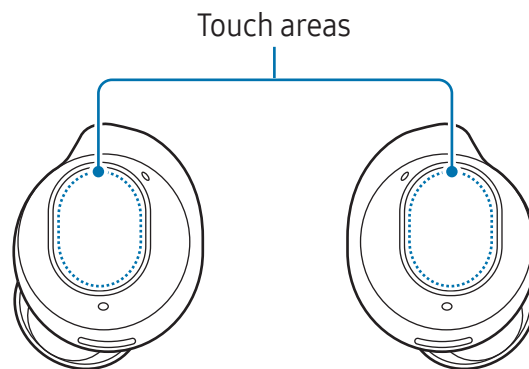
Touch the earbud to play or stop music or answer or decline calls. You can also set the earbuds to perform other actions by touch.



-  To avoid hurting your ears, do not apply excessive pressure to the earbuds.
- To avoid damaging the touch areas, do not touch the earbuds with anything sharp.
-  If you have a metal object, such as a piercing in your ear, remove it. If a metal object comes into contact with the earbuds, the earbuds' touch feature may malfunction or become unresponsive.
- If there is sweat or liquid on the earbuds, clean them. The earbuds' touch feature may malfunction or become unresponsive because of sweat or liquid.
- When using the earbuds' touch feature, do not cover the areas that will be touched with your hair. The touch feature may malfunction or become unresponsive.
- When the earbuds are removed from your ears, be careful not to touch their touch areas. This could result in unintentionally launching features.

## Understanding touch actions



### Single touch

- Play or pause track.
- Stop using the Read notifications aloud feature.



### Double touch

- Play next track.
- Answer or end a call.



### Triple touch

- Play previous track.
  - If you touch the earbud three times 3 seconds after a track begins playing, it will start the track from beginning. Touch the earbud three times within 3 seconds of when a track begins playing to play the previous track.



### Touch and hold

- Turn on the preset feature.
  - It is set by default to turn on the noise controls mode. Refer to [Setting a touch-and-hold feature](#) for more information about changing feature you want to turn on.
- Decline a call.



- The earbuds' touch actions are set to single touch and touch and hold by default. To use all the earbuds' touch actions, open the **Galaxy Wearable** app on your mobile device and tap **Touch controls** to turn on the related features.
- If the earbuds do not connect to a mobile device, the connection pop-up window does not appear, or your mobile device cannot find the earbuds, store them in the charging case and touch and hold both earbuds for more than 3 seconds to enter Bluetooth pairing mode manually. When Bluetooth pairing mode has been entered, the earbud battery indicator light will flash red and green.

## Locking the earbuds' touch feature

You can prevent unintended actions by locking the earbuds' touch feature.

### Activating from the Galaxy Wearable app

Open the **Galaxy Wearable** app on your mobile device and tap the **Touch controls** switch to turn it off.

### Activating from Settings

 This feature is available only on mobile devices running the Android 11 One UI version 3.1 and later.

- 1 Open **Settings** on your mobile device and tap **Connections** → **Bluetooth**.
- 2 Tap  next to the earbuds' name under **Paired devices**.
- 3 Tap the **Touch controls** switch to turn it off.

### Activating from the widget

Add the **Galaxy Buds FE Manager** widget to the mobile device and tap the button to lock the touch feature of the earbuds.

## Setting a touch-and-hold feature

You can set a touch-and-hold feature of each earbud to turn on features.



- 1 Open the **Galaxy Wearable** app on your mobile device, tap **Touch controls**, and then tap the switch to turn it on.
- 2 Tap the **Touch and hold** switch under **Triple tap** to turn it on.
- 3 Tap **Touch and hold** under **Triple tap** and select touch-and-hold features for each earbud under **Left** or **Right**.
  - **Switch noise controls:** Set to turn the following noise controls mode on or off: active noise cancelling and ambient sound mode. Refer to [Activating the noise controls mode](#) for more information.
  - **Bixby:** Start a conversation with an intelligent voice assistant service. When using Bixby, refer to [Using Bixby](#) for more information.
  - **Volume down / Volume up:** Adjust the volume.

-  • If you select the volume adjustment feature as one side's touch-and-hold feature, the other side's touch-and-hold feature is also automatically set to the volume adjustment feature.
- When the volume adjustment feature has been already selected and you try to change the one side's touch-and-hold feature, the other side's touch-and-hold feature is automatically set to turn on the noise controls mode.

## Using the noise controls mode

### Introduction

There are two noise controls mode: active noise cancelling and ambient sound mode. Turn on the active noise cancelling feature to reduce the volume of sounds around you. Use it when you want to avoid distractions, such as when listening to music. Conversely, turn on the ambient sound mode to hear your surroundings clearly, so you can detect any potentially dangerous situations or hear another person's voice during a conversation.



-  If the microphone (the outer microphone while wearing the earbuds) and its area are covered completely, feedback may occur when activating the noise controls mode.
-  You can only turn on the noise controls mode when wearing both earbuds in your ears.

### Activating the noise controls mode

#### Activating from the earbuds

Make sure that the touch-and-hold feature is set to **Switch noise controls** and then touch and hold the earbud.

The following noise controls mode will be launched: active noise cancelling and ambient sound mode.

-  If the touch-and-hold feature is set to **Switch noise controls** and includes an option with Off, the noise controls mode may turn off. Tap  next to **Switch noise controls** to check the option you selected.

## Activating from the Galaxy Wearable app

Open the **Galaxy Wearable** app on your mobile device and tap **Active noise cancelling** or **Ambient sound**.

## Activating from Settings

 This feature is available only on mobile devices running the Android 11 One UI version 3.1 and later.

- 1 Open **Settings** on your mobile device and tap **Connections** → **Bluetooth**.
- 2 Tap  next to the earbuds' name under **Paired devices**.
- 3 Tap **Active noise cancelling** or **Ambient sound** to turn it on.

## Activating from the widget

Add the **Galaxy Buds FE Manager** widget to the mobile device and tap the button to turn on the noise controls mode.

## Listening to music

Listen to music saved in your mobile device by connecting the earbuds to the mobile device. You can stream music played from the connected mobile device.

On your mobile device, open a music player app and play music.

 If you are listening to music through the earbuds and put the earbuds on the floor, the music may continue playing. The same situation may also occur if the charging case's battery has been completely discharged.

## Playing or pausing the track

Touch the earbud to play and pause the track.

## Playing the next track

Double touch the earbud to play the next track.



## Playing the previous track

Touch the earbud three times to play the previous track.

-  If you touch the earbud three times 3 seconds after a track begins playing, it will start the track from beginning. Touch the earbud three times within 3 seconds of when a track begins playing to play the previous track.

## Adjusting the volume

You can adjust the volume by touching and holding the earbud after setting it as a touch-and-hold feature.

- 
  - Adjust the volume through your connected mobile device if a sound is low in your earbuds while at full volume.
  - If you connect the earbuds to your mobile device while listening to music, the volume may change.
  - If you select the volume adjustment feature as one side's touch-and-hold feature, the other side's touch-and-hold feature is also automatically set to the volume adjustment feature.

- 1 Open the **Galaxy Wearable** app on your mobile device, tap **Touch controls**, and then tap the switch to turn it on.
- 2 Tap the **Touch and hold** switch under **Triple tap** to turn it on.
- 3 Tap **Touch and hold** under **Triple tap**, and select **Volume down** or **Volume up** under **Left** or **Right**.
- 4 Touch and hold the right earbud and release it when you reach the desired volume to increase the volume.  
Touch and hold the left earbud and release it when you reach the desired volume to decrease the volume.

## Using the equaliser

You can select from six different equaliser options and enjoy the same music with a different and unique sound.

Open the **Galaxy Wearable** app on your mobile device, tap **Earbuds settings** → **Equaliser**, and then select an option you want.

## Using call features

When wearing the earbuds while they are connected to a mobile device, you can answer and control calls from the connected mobile device.

-  • If you are not notified of the incoming call's phone number or the name saved in your contacts through voice notification, open the **Phone** app on your mobile device and tap **⋮** → **Settings** → **Answering and ending calls**, and then tap the **Read caller names aloud** switch to turn it on.
- If the touch feature of the earbuds does not work, open the **Galaxy Wearable** app on your mobile device, tap **Touch controls**, and then turn on the options under **Call controls**.

### Answering or declining a call

When a call comes in while you are wearing the earbuds, they will emit a sound and a voice notification will inform you of the incoming call's phone number or the name saved in your contacts.

To answer the call, double touch the earbud.

To decline the call, touch and hold the earbud.

### Ending a call

Double touch the earbud to end the current call.

# Bixby

## Introduction

Bixby is a user interface that helps you use your device more conveniently.

You can talk to Bixby or type text. Bixby will launch a feature you request or show the information you want on the connected mobile device. Visit [www.samsung.com/bixby](http://www.samsung.com/bixby) for more information.

-  • This feature is available only when a mobile device that supports Bixby is connected.
- Only some languages are available depending on Bixby set on your mobile device. Certain features may not be available depending on your region.

## Starting Bixby

Make sure you set a touch-and-hold feature for opening Bixby and touch and hold the earbud.

## Using Bixby

Touch and hold the earbud and say what you want. Alternatively, say the wake-up phrase and say what you want.

For example, while touching and holding the earbud, say “How’s the weather today?” The weather information will appear on your connected mobile device.

If Bixby asks you a question during a conversation, you can continue to talk to Bixby without touching and holding the earbud or tapping .

## Waking up Bixby using your voice

You can start a conversation with Bixby by saying “Hi, Bixby” or “Bixby” while wearing the earbuds.

- 1 Open the **Galaxy Wearable** app on your mobile device and tap **Earbuds settings**.
- 2 Tap **Bixby voice wake-up** and tap the switch to turn it on.

-  When you turn on this feature, the Bixby voice wake-up feature on your connected mobile device will also be turned on automatically.

## Communicating by typing text

If your voice is not recognised because of noisy environments or if you are in a situation where speaking is difficult, you can communicate with Bixby through text.

Touch and hold the earbud, tap , and then type what you want.

During the communication, Bixby also will answer you through text instead of voice feedback.

## Tips for better voice recognition

- Speak clearly.
- Speak in quiet places.
- Do not use offensive or slang words.
- Avoid speaking in dialectal accents.

The Galaxy Buds FE may not recognise what you say or may perform unwanted commands depending on your surroundings or how you speak.

# Galaxy Wearable app

## Introduction

To connect the earbuds to a mobile device, you must install the Galaxy Wearable app on your mobile device. You can check the Galaxy Buds FE's remaining battery and configure the settings with the Galaxy Wearable app.

Open the **Galaxy Wearable** app on your mobile device.

To search for settings by entering keywords, tap **Q**. You can also search for settings by selecting a tag under **Suggestions**.

- If it is the first time connecting the earbuds and a mobile device, refer to [Connecting the earbuds to a mobile device](#) for more information.
- Some features may not be available depending on the type of connected mobile device.

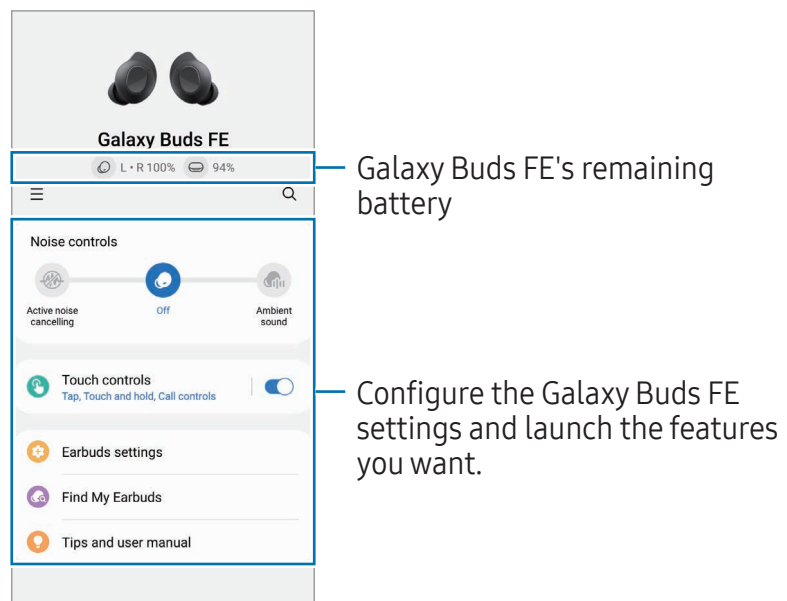

Tap **≡** to use the following additional options:



- **⚙️**: Configure the settings for the Galaxy Wearable app.
- **Add new device**: Disconnect your device from the currently connected phone and connect a new device. Follow the on-screen instructions to complete the connection. Refer to [Connecting and disconnecting the earbuds](#) for more information.

- **Manage devices:** Manage connected devices when more than two devices are connected with your phone. To disconnect a device from your phone, select a device and tap **Remove**.

## Connecting and disconnecting the earbuds

### Disconnecting mobile devices from the earbuds

Insert the earbuds into the charging case and close it. The Bluetooth connection will end.

To manually disconnect the earbuds from your mobile device, tap  →  on the Galaxy Wearable screen of your mobile device. Alternatively, open **Settings** on your mobile device, tap **Connections** → **Bluetooth**, and then disconnect the earbuds from your mobile device under **Paired devices**.

### Reconnecting mobile devices with the earbuds that temporarily disconnected

To reconnect the earbuds that temporarily disconnected from a device, insert them into the charging case and close it. Then, open the charging case again.

To manually reconnect the earbuds to your mobile device, tap **Connect** on the Galaxy Wearable screen of your mobile device.

### Connecting with new earbuds

You can temporarily disconnect the earbuds from your mobile device and connect additional ones.

On the Galaxy Wearable screen of your mobile device, tap  → **Add new device**.

## Connecting with other devices after disconnecting from the previous mobile device

- 1 Disconnect the earbuds from the previous mobile device. Open **Settings** on your mobile device, tap **Connections** → **Bluetooth**, and then unpair the earbuds from your mobile device under **Paired devices**.
- 2 Close the charging case and open it again to enter Bluetooth pairing mode.
- 3 Open the **Galaxy Wearable** app on your new mobile device and follow the on-screen instructions to complete the connection.

## Switch the mobile devices connected with earbuds

When the earbuds are connected with two or more mobile devices, you can switch the mobile devices without disconnecting from the previous mobile device.

On the mobile device that you want to switch to, open **Settings**, tap **Connections** → **Bluetooth**, and then select earbuds under **Paired devices**.

-  The connections between your earbuds and the mobile devices can be switched automatically under the circumstances. For example, when your earbuds are registered on both a tablet and a phone that are logged in to the same Samsung account, you can receive an incoming call from the phone with your earbuds while watching a video on the tablet since the earbuds' connection is switched to the phone automatically.

# Configuring settings for the Galaxy Buds FE

## Introduction

Check the status of the Galaxy Buds FE that are connected to your mobile device and configure their settings.

Open the **Galaxy Wearable** app on your mobile device.

-  Some features, such as the noise controls mode or Bixby voice wake-up, may affect the usage time of your earbuds.

## Setting the noise controls mode

Turn on or off the active noise cancelling or ambient sound mode based on your situation or surroundings. Also, you can set the ambient sound mode to turn on automatically.

On the Galaxy Wearable screen of your mobile device, select a feature and change its settings.

- **Active noise cancelling:** Reduce external sounds.
- **Off:** Turn off the noise controls mode.
- **Ambient sound:** Allows you to hear ambient sounds.

## Touch controls

Configure settings for the touch features of the earbuds.

On the Galaxy Wearable screen of your mobile device, tap **Touch controls**, and then tap the switch to turn it on.

- **Tap:** Play or pause track.
- **Double tap:** Play next track.
- **Triple tap:** Play previous track.
- **Touch and hold:** Select a feature to be used as the touch-and hold feature. Refer to [Setting a touch-and-hold feature](#) for more information.
- **Call controls:** Double touch the earbud to answer or end a call, and touch and hold to decline a call.

## Earbuds settings

Check information related to the earbuds and change various settings.

On the Galaxy Wearable screen of your mobile device, tap **Earbuds settings**.

### Equaliser

Select an equaliser option you want to use.

On the Galaxy Wearable screen of your mobile device, tap **Earbuds settings** → **Equaliser**, and then select an equaliser option you want.



## Earbud fit test

Check the earbuds' fit to ensure better sound and active noise cancelling.

- 1 On the Galaxy Wearable screen of your mobile device, tap **Earbuds settings** → **Earbud fit test**.
- 2 Wear the both earbuds in your ears and tap **Start**.  
The earbuds will emit a sound and the test will begin.  
If the results on the screen say you need to adjust your earbuds, try adjusting your earbuds or changing the ear tips, and tap **Try again** to start the test again.

 If you remove the earbuds from your ears during the earbud fit test, the test will stop.

## Read notifications aloud

You will receive notifications from the mobile device's apps through the earbuds.

On the Galaxy Wearable screen of your mobile device, tap **Earbuds settings** → **Read notifications aloud**.

- **Q** : You can search for apps to receive notifications from.
- **Read aloud while using phone**: Set the earbuds to receive notifications of the mobile device even when you are using the mobile device.
- **All apps**: Select the apps you want to receive notifications from and change the notification settings for each app. You can also tap **All** to check apps that are categorised by setting to read notifications or not to read notifications.

## Bixby voice wake-up

Wake Bixby with your voice to start a conversation with an intelligent voice assistance service.

On the Galaxy Wearable screen of your mobile device, tap **Earbuds settings** → **Bixby voice wake-up**, and then tap the switch to turn it on.

If you tap the **Speak seamlessly** switch to turn it on, you can say the command you want right away without waiting for audio feedback.

## Use Ambient sound during calls

Ambient sound can set up so that you can still hear your own voice clearly while speaking at a normal level, and it will enable you to listen more comfortably during long calls.

On the Galaxy Wearable screen of your mobile device, tap **Earbuds settings** → **Use Ambient sound during calls**, and then tap the switch to turn it on.

## In-ear detection for calls

You can set the earbuds or mobile device to play the call by detecting whether the earbuds are worn during the call.

On the Galaxy Wearable screen of your mobile device, tap **Earbuds settings** → **In-ear detection for calls**, and then tap the switch to turn it on.

When this feature is turned off, the caller's voice is played on the earbuds even if the earbuds are not worn.

## Seamless earbud connection

You can change which mobile device to connect your earbuds with. You can turn on the feature to switch the connection from your current mobile device to a nearby mobile device logged in to the same Samsung account or a device that has previously connected with your earbuds.

On the Galaxy Wearable screen of your mobile device, tap **Earbuds settings** → **Seamless earbud connection**, and then tap the switch to turn it on.

 Be careful not to connect your earbuds to another person's mobile device.

## Labs

Use new earbud features.

On the Galaxy Wearable screen of your mobile device, tap **Earbuds settings** → **Labs**.

- **Gaming mode:** Minimise audio delay to remove the lag between the video and sound output, and hear properly synced audio whenever playing games.



This feature is available only when connecting with a Samsung mobile device that uses the Android OS.

## Reset

You can reset all your earbuds settings.

On the Galaxy Wearable screen of your mobile device, and tap **Earbuds settings** → **Reset**.

## Accessibility

Configure various settings to improve the accessibility of the earbuds.

On the Galaxy Wearable screen of your mobile device, tap **Earbuds settings** → **Accessibility**.

- **Left/right sound balance:** Adjust the right and left volume balance if you have a hearing impairment or if using a single earbuds is more convenient. Drag the **Left/right sound balance** adjustment bar to adjust the balance. If you drag the bar to the left, the left earbud's volume will increase and vice versa.
- **Noise controls with one earbud:** Launch the noise controls feature with one earbud.
- **Amplify ambient sound:** You can set the sound to suit your hearing and preferences. Adjust the sound by dragging the adjustment bar under **Ambient sound volume** or **Ambient sound tone**.

## Earbuds software update

Update your earbuds' software through the firmware over-the-air (FOTA) service.

On the Galaxy Wearable screen of your mobile device, tap **Earbuds settings** → **Earbuds software update**.

- **Download and install:** Check for and install updates manually.
- **Auto update:** Set to install updates automatically when the earbuds are in the charging case.

## Diagnostics

Test your Galaxy Buds FE using Samsung Members.

On the Galaxy Wearable screen of your mobile device, tap **Earbuds settings** → **Diagnostics**.

## About earbuds

Access the information of the Galaxy Buds FE.

On the Galaxy Wearable screen of your mobile device, tap **Earbuds settings** → **About earbuds**.

To change your Galaxy Buds FE's name, tap **Edit**.

- **Legal information:** Check the legal information for the Galaxy Buds FE.
- **Software information:** Check the earbuds' software information.
- **Battery information:** Check the earbuds and charging case's battery information.

## Find My Earbuds

If you misplace your earbuds, use the SmartThings Find feature of the SmartThings app installed on your connected mobile device can help you find it.

On the Galaxy Wearable screen of your mobile device, tap **Find My Earbuds**.

The SmartThings Find screen that is available through the SmartThings app will appear on your mobile device and you can check your misplaced earbuds' location on the map. Also, you can find them by following the sound emitted from your earbuds.



- SmartThings Find feature support may vary depending on the software version of the connected mobile device.
- The screen may be switched automatically to find your earbuds with the SmartThings Find feature if the connected mobile device supports the SmartThings Find feature.
- To find your earbuds using the SmartThings Find feature, SmartThings Find's Lost mode must be turned on, and the features related to finding devices offline must also be turned on.
- If the earbuds you are trying to find are outside the charging case, it may take 4 minutes or more to search nearby to find the earbuds.



# Usage notices

## Precautions for using the device

Please read this manual when using the device to ensure safe and proper use.

- Descriptions are based on the device's default settings.
- Some content may differ from your device depending on the region, service provider, model specifications, or device's software.
- Before using other mobile devices, make sure they are compatible with the device. Visit the Samsung website to check the specifications of compatible mobile devices.
- Software, sound sources, wallpapers, images, and other media provided with this device are licensed for limited use. Extracting and using these materials for commercial or other purposes is an infringement of copyright laws. Users are entirely responsible for illegal use of media.
- Default apps that come with the device are subject to updates and may no longer be supported without prior notice.
- Modifying the device's operating system or installing software from unofficial sources may result in device malfunctions and data damage or loss. These actions are violations of your Samsung licence agreement and will void your warranty.
- Some functions may not work as described in this manual depending on the maker and model of the mobile device you connect to the device.
- This product includes certain free/open source software. The licence information of the open source software used in this product can be found at [opensource.samsung.com](https://opensource.samsung.com).
- Your device contains magnets. Keep it away from credit cards, implanted medical devices, and other devices that may be affected by magnets. In the case of medical devices, keep your device more than 15 cm apart. Stop using your device if you suspect any interference with your medical device and consult your physician or your medical device manufacturer.
- This product operates using magnets. Do not store your device near magnetic fields. Doing so may cause malfunctions.

## Instructional icons

-  **Warning:** situations that could cause injury to yourself or others
-  **Caution:** situations that could cause damage to your device or other equipment
-  **Notice:** notes, usage tips, or additional information

## Notes on package contents and accessories

Refer to the quick start guide for package contents.

- The items supplied with the Galaxy Buds FE and any available accessories may vary depending on the region or carrier.
- The supplied items are designed only for this Galaxy Buds FE and may not be compatible with other devices.
- Appearances and specifications are subject to change without prior notice. Also, the size of the ear tips are subject to change to provide a better fit.
- You can purchase additional accessories from your local Samsung retailer. Make sure they are compatible with the Galaxy Buds FE before purchase.
- Use Samsung-approved accessories. Using unapproved accessories may cause the performance problems and malfunctions that are not covered by the warranty.
- Availability of all accessories is subject to change depending entirely on manufacturing companies. For more information about available accessories, refer to the Samsung website.

## Precautions for using the earbuds

- Excessive exposure to loud sounds can cause hearing damage.
- Using the earbuds while walking may distract your attention and cause an accident.
- Always turn the volume down before using the earbuds and use only the minimum volume setting necessary to hear your conversation or music.
- If your ears or earbuds are wet or have foreign materials on them, or if you have prolonged skin contact with the earbuds, it may result in skin irritation. Make sure that your ears and earbuds are clean and dry before wearing the earbuds.
- In dry environments, static electricity can build up in the earbuds. Avoid using earbuds in dry environments or touch a metal object to discharge static electricity before using the earbuds.
- Do not use earbuds while driving or riding. Doing so may distract your attention and cause an accident, or may be illegal depending on your region.
- Although the Galaxy Buds FE comply with international safety standards, inserting the earbuds forcefully or wearing them for a long time may cause pain or skin irritation.
- If you experience any skin irritation while you are wearing the earbuds, stop wearing them immediately and consult a specialist.
- Do not clean the earbuds with compressed air or use ultrasonic waves or external heat sources if dust, sweat, ink, oil, or chemicals (cosmetics, sunscreen, antibacterial spray, hand sanitiser, detergent, insecticide, etc.) come into contact with the earbuds and charging case. Discolouration or corrosion may cause damage to the Galaxy Buds FE.
- Remove the ear tips, wash the outside and the mesh part with clean water, and then dry them thoroughly after use. Wipe the earbuds with a soft, dry cloth if they are contaminated.

# Cleaning and managing the Galaxy Buds FE

## Basic maintenance

- Use a soft, dry cloth to clean the earbuds after use.
- Keep the earbuds dry. Prevent liquid from contacting or entering the earbuds.
- Clean the earbuds regularly to prevent earwax or debris from building up in the microphone hole, speaker, and air duct.

## Cleaning the microphone hole, speaker, and air duct

If the volume is lower than it should be with the current setting, clean the microphone hole, speaker, and air duct. Before cleaning the speaker, detach the ear tip from the latch at the bottom of the earbud.

Remove any earwax or debris with a clean, dry, and soft brush, cotton swabs, or other tools.

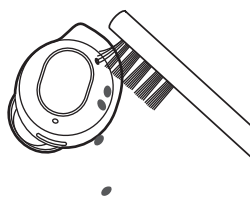

Microphone hole

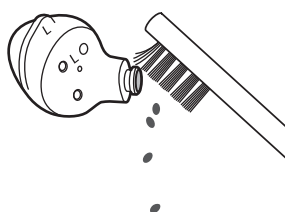

Speaker



Air duct

- ⚠ Do not use anything sharp or excessive force while removing earwax or debris. The microphone hole, speaker, and air duct may be damaged.



## Cleaning the charging contacts

If the battery does not charge properly, wipe the charging contacts with a dry cloth.

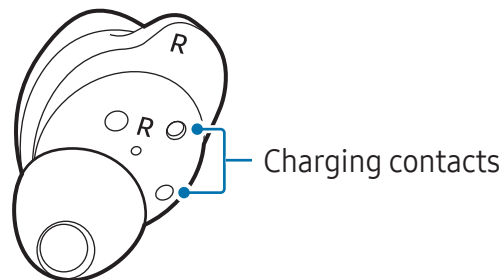

## Cleaning the earbuds and charging case

When the earbuds and charging case are exposed to foreign materials, such as dust, sand, or metal shavings, the Galaxy Buds FE may not charge properly or may be damaged. If the earbuds or the charging case were exposed to foreign materials, wipe them with a soft and dry cloth before inserting them into the charging case.

## Restarting the earbuds

If the earbuds' touch feature malfunctions or become unresponsive, and the earbuds do not work properly, restart the earbuds.

To restart the earbuds, insert the earbuds into their corresponding slots in the charging case, which is not discharged, close the charging case, and then remove them after 7 seconds or more.

 If the charging case has low battery, connect the charging case to the charger first.

## Coupling the earbuds

When you lose one of the earbuds, you do not have to purchase a new set of earbuds because you can make a new set of earbuds with a newly purchased earbud and the other earbud that you already have.

- 1 Check the direction of each earbud, the newly purchased earbud and previously used earbud, and correctly insert them into their corresponding slots in the charging case.
- 2 Touch and hold both earbuds for 7 seconds or more.  
The earbud battery indicator light will flash green and turn off. Then, the earbuds are coupled.  
 The earbud battery indicator light will keep flashing red when the earbuds are not coupled properly. Remove the earbuds from the charging case and insert them again. Then, touch and hold both earbuds for 7 seconds or more.
- 3 Connect the earbuds to a mobile device. For more information, refer to [Connecting the earbuds to a mobile device](#).

# Appendix

## Troubleshooting

Before contacting a Samsung Service Centre or an authorised service centre, please attempt the following solutions. Some situations may not apply to your Galaxy Buds FE. You can also use Samsung Members to solve any problems you might encounter while using your device.

### Your earbuds do not work

- The battery may be completely discharged. Charge the battery completely before using the earbuds.
- If an earbud's touch-sensitive sensor does not make contact with your ear, the earbud may not work. If you do not hear a sound informing you that the earbuds are detected, remove the earbuds from your ears and put them in again.
- If the earbuds' touch feature malfunctions or become unresponsive, and the earbuds do not work properly, insert the earbuds into their corresponding slots in the charging case, which is not discharged, close the charging case, and then remove them after 7 seconds or more.

### Bluetooth device cannot locate your earbuds

- Close the charging case again and open it to enter the Bluetooth pairing mode.
- Ensure that your earbuds and the other Bluetooth device are within the maximum Bluetooth connection range (10 m). The distance may vary depending on the environment the devices are used in.

If the tips above do not solve the problem, contact a Samsung Service Centre or an authorised service centre.

## A Bluetooth connection is not established or your earbuds and the mobile device are disconnected

- Ensure there are no obstacles, such as walls or electrical equipment, between the devices.
- Ensure that the latest version of the Galaxy Wearable app is installed on the mobile device. If the Galaxy Wearable app is not latest version, update the Galaxy Wearable app to the latest version.
- Ensure that your earbuds and the other Bluetooth device are within the maximum Bluetooth connection range (10 m). The distance may vary depending on the environment the devices are used in.
- Restart the mobile device and reopen the **Galaxy Wearable** app.
- If only a single earbud is connected to your mobile device, restart the earbuds to connect them both. To restart the earbuds, refer to [Restarting the earbuds](#) for more information.

## The battery does not charge properly (For Samsung-approved chargers)

- Ensure that the charging contacts of the earbuds and the charging contacts of the charging case are in contact with each other.
- Ensure that the charger is connected properly to the charging case.
- If the charging contacts are dirty, the battery may not charge properly. Wipe the charging contacts with a dry cloth and try charging the battery again.

If the tips above do not solve the problem, contact a Samsung Service Centre or an authorised service centre.

## The charging time and the battery life is different between the earbuds

- The charging time may differ between the two earbuds even if they started charging at the same time.
- The charging time and the remaining battery may differ between the two earbuds because of different inner components.

## The battery depletes faster than when first purchased

- When you expose the Galaxy Buds FE to very cold or very hot temperatures, the useful charge may be reduced.
- The battery is consumable and the useful charge will get shorter over time.
- When you are not using the earbuds, store them in a charging case that has been charged. If not, the touch-sensitive sensor will continue to work, and it will affect to the usage time and battery consumption.

## You cannot hear others speaking

Adjust the volume on the connected mobile device.

## Sound echoes during a call

Adjust the volume on the connected mobile device or move to another area.

## Sound is emitted from the connected mobile device, not the earbuds, during a call

- Check if you are wearing the earbuds properly. If worn improperly, you will not be able to hear the call audio through the earbuds, even if the Bluetooth icon appears on the connected mobile device.
- Remove the earbuds from your ears and put them in again.

## Audio quality is poor

- Wireless network services may be disabled because of issues with the carrier's network. Ensure to keep the earbuds away from electromagnetic waves.
- Ensure that your earbuds and the other Bluetooth device are within the maximum Bluetooth range (10 m). The distance may vary depending on the environment the devices are used in.
- You may experience drops in volume or noise depending on the connected device's volume. To avoid this, appropriately adjust the connected device's sound.

## **Your earbuds sound comes slower than the screen when playing videos and games**

The earbuds may have a time lag between the video and sound output when playing videos or games when connected to a mobile device.

## **The noise controls mode does not work well**

- Wear both earbuds in your ears and launch active noise cancelling feature, which is one of the noise controls mode. If you are unsure if the active noise cancelling feature is turned on, check it on the Galaxy Wearable app.
- Check whether there is a buildup of foreign materials in the microphones located at the top and bottom of the earbuds, and clean them if required.
- Ensure that the latest software version is installed on the earbuds.

## **Your Galaxy Buds FE are hot to the touch**

When you use the Galaxy Buds FE for an extended period of time, they may feel hot to the touch. This is normal and should not affect your Galaxy Buds FE's lifespan or performance.

If the Galaxy Buds FE overheat or feel hot for a prolonged period, do not use them for a while. If the Galaxy Buds FE continue to overheat, contact a Samsung Service Centre or an authorised service centre.

## **A small gap appears around the outside of the Galaxy Buds FE**

- This gap is a necessary manufacturing feature and some minor rocking or vibration of parts may occur.
- Over time, friction between parts may cause this gap to expand slightly.

## **When the earbuds are removed from your ears, the ear tips are turned upside down**

Depending on how you wear the earbuds and the direction in which the earbuds are removed, the ear tips may turn over. In this case, turn them over in the original direction and use it again.

## Removing the battery

- To remove the battery, contact an authorised service centre. To obtain battery removal instructions, please visit [www.samsung.com/global/ecodesign\\_energy](http://www.samsung.com/global/ecodesign_energy).
- For your safety, you **must not attempt to remove** the battery. If the battery is not properly removed, it may lead to damage to the battery and device, cause personal injury, and result in the device being unsafe.
- Samsung does not accept liability for any damage or loss (whether in contract or tort, including negligence) which may arise from failure to precisely follow these warnings and instructions, other than death or personal injury caused by Samsung's negligence.

## Copyright

Copyright © 2023 Samsung Electronics Co., Ltd.

This manual is protected under international copyright laws.

No part of this manual may be reproduced, distributed, translated, or transmitted in any form or by any means, electronic or mechanical, including photocopying, recording, or storing in any information storage and retrieval system.

## Trademarks

- SAMSUNG and the SAMSUNG logo are registered trademarks of Samsung Electronics Co., Ltd.
- Bluetooth® is a registered trademark of Bluetooth SIG, Inc. worldwide.
- All other trademarks and copyrights are the property of their respective owners.

Model: SM-R400N

Rated voltage/current:

5 V / 200 mA (earbuds)

5 V / 900 mA (charging case), 3.85 V (internal battery)

Made in Vietnam by Samsung

PO BOX 12987, DUBLIN. IE

