

SAMSUNG

FULL MANUAL

HW-S40T / S41T

Imagine the possibilities









Thank you for purchasing this Samsung product.

To receive more complete service, please register
your product at www.samsung.com/register

SAFETY INFORMATION

SAFETY WARNINGS

TO REDUCE THE RISK OF ELECTRIC SHOCK, DO NOT REMOVE THE COVER (OR BACK). NO USER-SERVICEABLE PARTS ARE INSIDE. REFER SERVICING TO QUALIFIED SERVICE PERSONNEL.
Refer to the table below for an explanation of symbols which may be on your Samsung product.

	CAUTION RISK OF ELECTRIC SHOCK. DO NOT OPEN.	
	<p>This symbol indicates that high voltage is present inside. It is dangerous to make any kind of contact with any internal part of this product.</p>	
	<p>This symbol indicates that this product comes with important literature concerning operation and maintenance.</p>	
	<p>Class II product : This symbol indicates that a safety connection to electrical earth (ground) is not required. If this symbol is not present on a product with a power cord, the product MUST have a reliable connection to protective earth (ground).</p>	
	<p>AC voltage : Rated voltage marked with this symbol is AC voltage.</p>	
	<p>DC voltage : Rated voltage marked with this symbol is DC voltage.</p>	
	<p>Caution. Consult Instructions for use : This symbol instructs the user to consult the user manual for further safety related information.</p>	

WARNING

- To reduce the risk of fire or electric shock, do not expose this appliance to rain or moisture.
- To prevent injury, this apparatus must be securely attached to the floor/wall in accordance with the installation instructions.
- This product contains chemicals known to the State of California to cause cancer and birth defects or other reproductive harm.

CAUTION

- Do not expose this apparatus to dripping or splashing. Do not put objects filled with liquids, such as vases, on the apparatus.
- To turn this apparatus off completely, you must pull the power plug out of the wall socket. Consequently, the power plug must be easily and readily accessible at all times.

FCC NOTE (for U.S.A):

FCC Supplier's Declaration of Conformity

Responsible Party - U.S. Contact Information:

Samsung Electronics America, Inc.
85 Challenger Road.
Ridgefield Park, NJ 07660
Phone: 1-800-SAMSUNG (726-7864)

FCC Compliance Statement :

This device complies with Part 15 of the FCC Rules. Operation is subject to the following two conditions:

- (1) This device may not cause harmful interference, and (2) this device must accept any interference received, including interference that may cause undesired operation.

FCC Caution :

- Any changes or modifications not expressly approved by the party responsible for compliance could void the user's authority to operate this equipment.
- This product satisfies FCC regulations when shielded cables and connectors are used to connect the unit to other equipment. To prevent electromagnetic interference with electric appliances, such as radios and televisions, use shielded cables and connectors for connections.

Class B FCC Statement

This equipment has been tested and found to comply with the limits for a Class B digital device, pursuant to Part 15 of the FCC Rules. These limits are designed to provide reasonable protection against harmful interference in a residential installation. This equipment generates, uses and can radiate radio frequency energy and, if not installed and used in accordance with the instructions, may cause harmful interference to radio communications. However, there is no guarantee that interference will not occur in a particular installation. If this equipment does cause harmful interference to radio or television reception, which can be determined by turning the equipment off and on, the user is encouraged to try to correct the interference by one of the following measures:

- Reorienting or relocating the receiving antenna.
- Increasing the separation between the equipment and receiver.
- Connecting the equipment to an outlet that is on a different circuit than the radio or TV.
- Consulting the dealer or an experienced radio/TV technician for help.

FCC Radiation Exposure Statement :

This equipment complies with FCC radiation exposure limits set forth for an uncontrolled environment. This equipment should be installed and operated so there is at least 8 inches (20 cm) between the radiator and your body. This device and its antenna(s) must not be co-located or operated in conjunction with any other antenna or transmitter.

CALIFORNIA USA ONLY (Applicable for networking models only.)

This Perchlorate warning applies only to primary CR(Manganese Dioxide) Lithium coin cells in the product sold or distributed ONLY in California USA "Perchlorate Material - special handling may apply, See www.dtsc.ca.gov/hazardouswaste/perchlorate."

Dispose unwanted electronics through an approved recycler. To find the nearest recycling location, go to our website:www.samsung.com/recycling Or call, 1-800-SAMSUNG

 **WARNING: Cancer and Reproductive Harm**
- www.P65Warnings.ca.gov.

Important Safety Instructions

Read these operating instructions carefully before using the unit. Follow all the safety instructions listed below. Keep these operating instructions handy for future reference.

1. Read these instructions.
2. Keep these Instructions.
3. Heed all warnings.
4. Follow all instructions.
5. Do not use this apparatus near water.
6. Clean only with dry cloth.

7. Do not block any ventilation openings.
Install in accordance with the manufacturer's instructions.
8. Do not install near any heat sources such as radiators, heat registers, stoves, or other apparatus (including amplifiers) that produce heat.
9. Do not defeat the safety purpose of the polarized or grounding-type plug.
A polarized plug has two blades with one wider than the other. A grounding type plug has two blades and a third grounding prong. The wide blade or the third prong are provided for your safety. If the provided plug does not fit into your outlet, consult an electrician for replacement of the obsolete outlet.
10. Protect the power cord from being walked on or pinched particularly at plugs, convenience receptacles, and the point where they exit from the apparatus.
11. Only use attachments/accessories specified by the manufacturer.
12. Use only with the cart, stand, tripod, bracket, or table specified by the manufacturer, or sold with the apparatus.
When a cart is used, use caution when moving the cart/apparatus combination to avoid injury from tip-over.
13. Unplug this apparatus during lightning storms or when unused for long periods of time.



14. Refer all servicing to qualified service personnel. Servicing is required when the apparatus has been damaged in any way, such as power-supply cord or plug is damaged, liquid has been spilled or objects have fallen into the apparatus, the apparatus has been exposed to rain or moisture, does not operate normally, or has been dropped.

PRECAUTIONS

1. Ensure that the AC power supply in your house complies with the power requirements listed on the identification sticker located on the bottom of your product. Install your product horizontally, on a suitable base (furniture), with enough space around it for ventilation (3~4 inches). Make sure the ventilation slots are not covered. Do not place the unit on amplifiers or other equipment which may become hot. This unit is designed for continuous use. To fully turn off the unit, disconnect the AC plug from the wall outlet. Unplug the unit if you intend to leave it unused for a long period of time.
2. During thunderstorms, disconnect the AC plug from the wall outlet. Voltage peaks due to lightning could damage the unit.
3. Do not expose the unit to direct sunlight or other heat sources. This could lead to overheating and cause the unit to malfunction.

4. Protect the product from moisture (i.e. vases), and excess heat (e.g. a fireplace) or equipment creating strong magnetic or electric fields. Unplug the power cable from the AC wall socket if the unit malfunctions. Your product is not intended for industrial use. It is for personal use only. Condensation may occur if your product has been stored in cold temperatures. If transporting the unit during the winter, wait approximately 2 hours until the unit has reached room temperature before using.
5. The battery used with this product contains chemicals that are harmful to the environment. Do not dispose of the battery in the general household trash. Do not expose the battery to excess heat, direct sunlight, or fire. Do not short circuit, disassemble, or overheat the battery. Danger of explosion if the battery is replaced incorrectly. Replace only with the same or equivalent type.

Fabric cleaning

Remove any dirt or stain on the product surface immediately.

Removing and cleaning can be less effective for some substances or if left for a prolonged time.

CAUTION

- Use a vacuum cleaner or an adhesive lint roller to remove dust, handprints, and the likes.
 - Some cleaning brushes may damage the product, depending on the materials they contain.
 - Towels and cleaning clothes may leave lint or dirt on the product.
- Do not use a nail or other tools to scratch the dirt off. It may damage the fabric.
- To remove oil or liquid stains, use a clean white cloth moist with water. If the stain persists, wipe it with a mixture of water and neutral detergent (such as dishwashing soaps) and a cloth.
 - A non-neutral detergent or cleaner may cause discoloration or fabric damage.
 - After cleaning, use a dry cloth or hairdryer to dry the area.
 - Do not use excessive force to avoid discoloration or fabric damage.

CONTENTS

01	Checking the Components	8
	Inserting Batteries before using the Remote Control (AA batteries X 2)	8
02	Product Overview	9
	Top Panel of the Soundbar	9
	Bottom Panel of the Soundbar	10
03	Using the Remote Control	11
	How to Use the Remote Control	11
	Adjusting the Soundbar volume with a TV remote control	14
04	Connecting the Soundbar	15
	Connecting Electrical Power	15
05	Using a wired connection to the TV	16
	Connecting using an Optical Cable	16
06	Using a wireless connection to the TV	17
	Connecting via Bluetooth	17
07	Connecting an External Device	19
	Connecting using an Optical Cable	19

08	Connecting a Mobile Device	20
	Connecting via Bluetooth	20
	Using Tap Sound	24
09	Installing on a wall	25
10	Installing the Soundbar in front of TV	25
11	Software Update	26
	Initialization	27
12	Troubleshooting	28
13	License	29
14	Open Source License Notice	30
15	Important Notes About Service	30
16	Specifications and Guide	31
	Specifications	31

01 CHECKING THE COMPONENTS

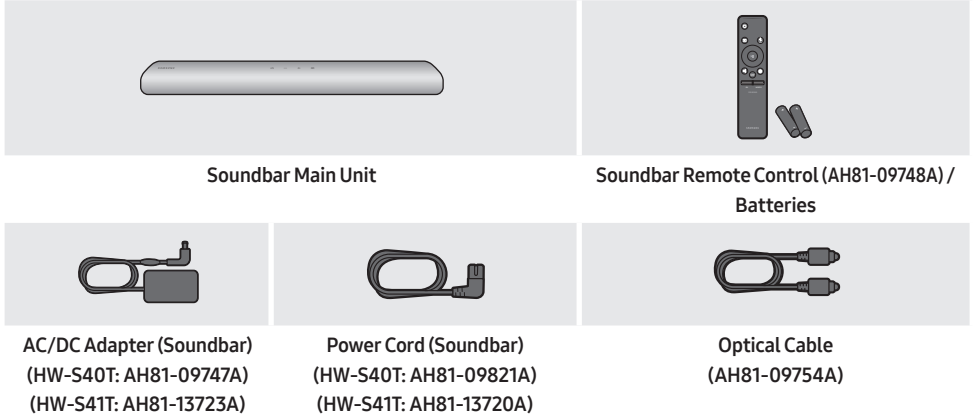

- For more information about the power supply and power consumption, refer to the label attached to the product. (Label: Bottom of the Soundbar Main Unit)
- To purchase additional components or optional cables, contact a Samsung Service Center or Samsung Customer Care.
- There are two wall mount holes (M4 size) at the bottom of the Soundbar. Individually purchase a compatible bracket and mount the Soundbar on a wall to suit your preferences.
- Design, specifications are subject to change without prior notice.
- The appearance of the accessories may differ slightly from the illustrations above.

Inserting Batteries before using the Remote Control (AA batteries X 2)



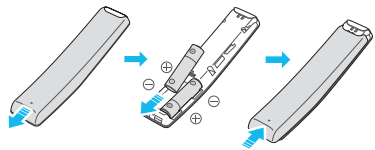





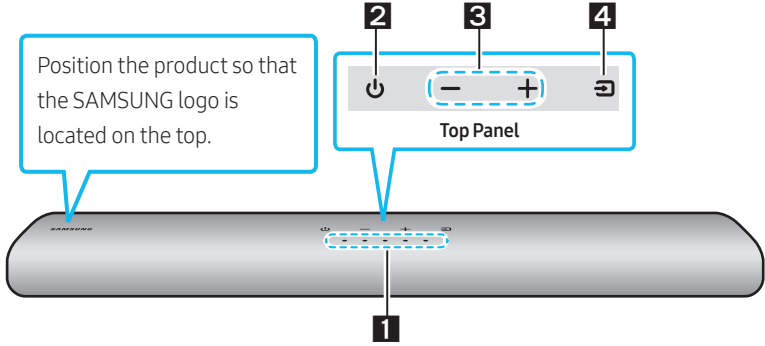













Slide the back cover in the direction of the arrow until it is completely removed. Insert 2 AA batteries (1.5V) oriented so that their polarity is correct. Slide the back cover back into position.

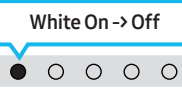

02 PRODUCT OVERVIEW

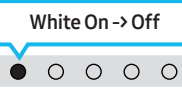
Top Panel of the Soundbar

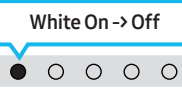

<p>1</p>	<p>LED indicator</p>	<p>The LED Indicator flashes, glows, or changes color depending on the Soundbar's current mode or status. The color of the LED indicator and the number of lights indicate the active mode as described below.</p> <table border="1" data-bbox="266 751 1028 831"> <tr> <td data-bbox="266 751 404 831">  White LED </td> <td data-bbox="404 751 542 831">  White LED </td> <td data-bbox="542 751 679 831">  Multicolor LED </td> <td data-bbox="679 751 817 831">  White LED </td> <td data-bbox="817 751 1028 831">  White LED </td> </tr> </table> <ul style="list-style-type: none"> The Multicolor LED changes to White, Cyan, Green, Red, Yellow, Orange, Purple and Blue depending on the mode or status. 	 White LED	 White LED	 Multicolor LED	 White LED	 White LED	
 White LED	 White LED	 Multicolor LED	 White LED	 White LED				
<p>2</p>	<p>Power</p>	<p>Turns the power on and off.</p>						
<p>3</p>	<p>Volume</p>	<p>Adjusts the volume.</p>						
<p>4</p>	<p>Source</p>	<ul style="list-style-type: none"> Press the  (Source) button to change the mode. Each time you change the mode, the LED lights in white and then turns off. <table border="1" data-bbox="266 1106 1028 1273"> <tr> <td data-bbox="266 1106 404 1217"> <p>LED Indicator</p> </td> <td data-bbox="404 1106 714 1217">  <p>White On -> Off</p> </td> <td data-bbox="714 1106 1028 1217">  <p>White On -> Off</p> </td> </tr> <tr> <td data-bbox="266 1217 404 1273">  </td> <td data-bbox="404 1217 714 1273"> <p>"Digital Audio In"</p> </td> <td data-bbox="714 1217 1028 1273"> <p>"Bluetooth"</p> </td> </tr> </table>	<p>LED Indicator</p>	 <p>White On -> Off</p>	 <p>White On -> Off</p>		<p>"Digital Audio In"</p>	<p>"Bluetooth"</p>
<p>LED Indicator</p>	 <p>White On -> Off</p>	 <p>White On -> Off</p>						
	<p>"Digital Audio In"</p>	<p>"Bluetooth"</p>						

- When you plug in the AC cord, the power button will begin working in 4 to 6 seconds.
- When you turn on this unit, there will be a 4 to 5 second delay before it produces sound.
- If you hear sounds from both the TV and Soundbar, go to the **Settings** menu for the TV audio and change the TV speaker to **External Speaker**.

Bottom Panel of the Soundbar

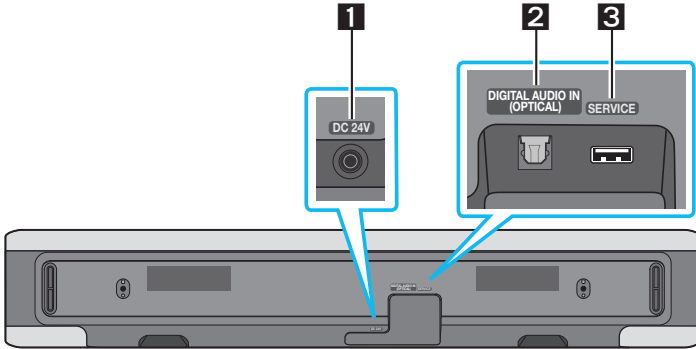

1	DC 24V (Power Supply In) Connect the AC/DC power adaptor.
2	DIGITAL AUDIO IN (OPTICAL) Connect to the digital (optical) output of an external device.
3	SERVICE Connect a USB storage device to upgrade the product's software.

- When disconnecting the power cable of the AC/DC power adaptor from a wall outlet, pull the plug. Do not pull the cable.
- Do not connect this unit or other components to an AC outlet until all connections between components are complete.

03 USING THE REMOTE CONTROL

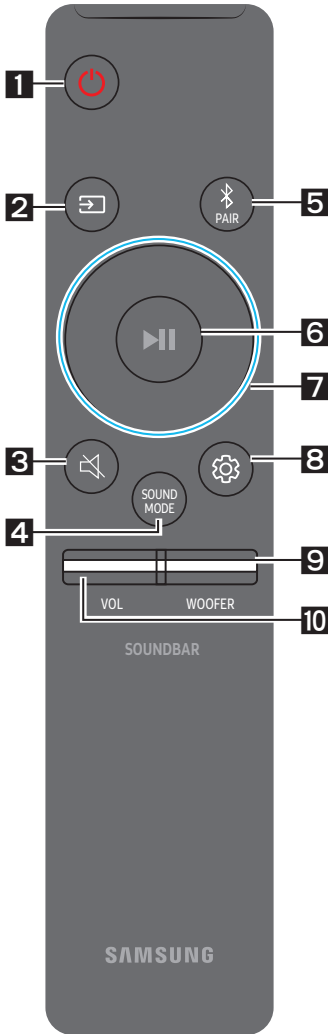

How to Use the Remote Control



1	Power Turns the Soundbar on and off. <table border="1" data-bbox="515 367 1041 502"><tr><td data-bbox="515 367 616 502">LED Indicator</td><td data-bbox="616 367 828 502">Cyan Blinks X1 ○ ○ ● ○ ○ On</td><td data-bbox="828 367 1041 502">Red Blinks X3 ○ ○ ● ○ ○ Off</td></tr></table> <ul style="list-style-type: none">Auto Power Down Function The unit turns off automatically in the following situations:<ul style="list-style-type: none">In "Digital Audio In" / "Bluetooth" mode if there is no audio signal for 20 minutes.	LED Indicator	Cyan Blinks X1 ○ ○ ● ○ ○ On	Red Blinks X3 ○ ○ ● ○ ○ Off
LED Indicator	Cyan Blinks X1 ○ ○ ● ○ ○ On	Red Blinks X3 ○ ○ ● ○ ○ Off		
2	Source Press to select a source connected to the Soundbar.			
3	Mute Press the Mute button to mute the sound. Press it again to unmute the sound. <table border="1" data-bbox="515 861 1041 973"><tr><td data-bbox="515 861 616 973">LED Indicator</td><td data-bbox="616 861 1041 973">Blinks X Repeatly ○ ○ ○ ○ ●</td></tr></table>	LED Indicator	Blinks X Repeatly ○ ○ ○ ○ ●	
LED Indicator	Blinks X Repeatly ○ ○ ○ ○ ●			

4**SOUND MODE**

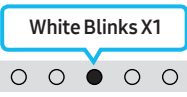
By pressing the button, you can select the desired audio mode. Each time the mode changes, the Multicolor LED blinks in white.

LED Indicator	
	"Standard" → "Smart" → "Music"

- **Standard**
Outputs the original sound.
- **Smart**
Analyzes the content in real time and automatically provides the optimal sound field based on the characteristics of the content.
- **Music**
Provides more natural and room filling sound for music content.

5**Bluetooth PAIR**

Switch the Soundbar to Bluetooth pairing mode.

When you press the button, the LED display changes as shown below.

- Until pairing is complete, the Multicolor LED changes as **Red** → **Green** → **Blue** in turn.

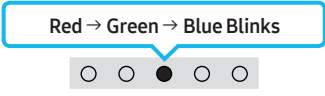
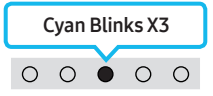
LED Indicator		→	
---------------	---	---	---

6**▶|| (Play / Pause)**

You can also play or pause music by pressing the button.



7**Up/Down/Left/Right**

Press **Up/Down/Left/Right** on the button to select or set functions.

- **Music Skip**
Press the **Right** button to select the next music file. Press the **Left** button to select the previous music file.

8**⚙️ (Sound Control)**

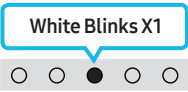
By pressing the button, you can select the desired audio mode. The desired item can be adjusted using the **Up/Down** buttons. Each time the mode changes, the Multicolor LED blinks in white.

LED Indicator	
	"Treble" → "Bass" → "Sync"

9**WOOFER (BASS) LEVEL**

Push the button up or down to adjust the woofer (bass) between -6 to +6. To set the woofer (bass) volume level to 0 (Default), press the button.

10**VOLUME**

Push the button up or down to adjust the volume.

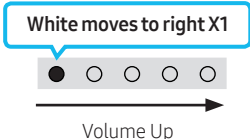
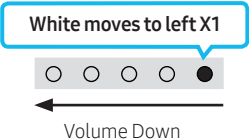
LED Indicator		
---------------	---	---

Adjusting the Soundbar volume with a TV remote control







Adjust the Soundbar volume using the TV's remote control.

- This function can be used with IR remote controls only. Bluetooth remote controls (remote controls that require pairing) are not supported.
- Set the TV speaker to **External Speaker** to use this function.
- Manufacturers supporting this function:
VIZIO, LG, Sony, Sharp, PHILIPS, PANASONIC, TOSHIBA, Hisense, RCA

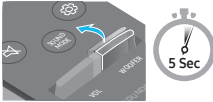
1. Turn Off the Soundbar.
2. Push up and hold the **WOOFER** button for 5 seconds.

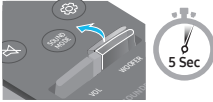
Each time you push the **WOOFER** button up and hold it for 5 seconds, the mode switches in the following order: "**Samsung-TV Remote**" (Default mode), "**Off-TV Remote**", "**All-TV Remote**".

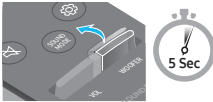
The LED indicator status changes each time the mode is changed, as shown below.

Remote Control Button	LED Indicator	Status
	<div style="border: 1px solid blue; padding: 2px; display: inline-block;">Blue Blinks X1</div>  "Samsung-TV Remote" (Default mode)	Enable a Samsung TV's IR remote control.
	<div style="border: 1px solid red; padding: 2px; display: inline-block;">Red Blinks X1</div>  "Off-TV Remote"	Disable the TV remote control.
	<div style="border: 1px solid green; padding: 2px; display: inline-block;">Green Blinks X1</div>  "All-TV Remote"	Enable a third-party TV's IR remote control.

04 CONNECTING THE SOUNDBAR

Connecting Electrical Power

Use the power components to connect the Soundbar to an electrical outlet in the following order:

- For more information about the required electrical power and power consumption, refer to the label attached to the product. (Label: Bottom of the Soundbar Main Unit)

1. First connect the power cable to the AC/DC adapter.
Connect the AC/DC adapter (with the power cable) to the Soundbar.
2. Connect the power cord to a wall socket.

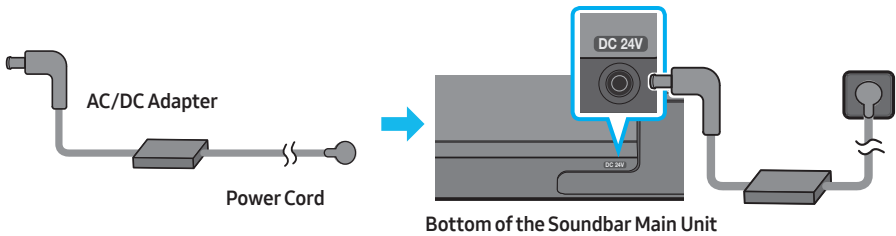

NOTES

- If you unplug and reconnect the power cord when the product is turned on, the Soundbar turns on automatically.
- Make sure to rest the AC/DC Adapter flat on a table or the floor. If you place the AC/DC Adapter so that it is hanging with the AC cord input facing upwards, water or other foreign substances could enter the Adapter and cause the Adapter to malfunction.

05 USING A WIRED CONNECTION TO THE TV

Connecting using an Optical Cable

When the audio in a broadcast is encoded in Dolby Digital and the “Digital Output Audio Format” on your TV is set to PCM, we recommend that you change the setting to Dolby Digital. When the setting on the TV is changed, you will experience better sound quality. (The TV menu may use different words for Dolby Digital and PCM depending on the TV manufacturer.)

Pre-connection Checklist

- When you use an optical cable and the terminals have covers, be sure to remove the covers.

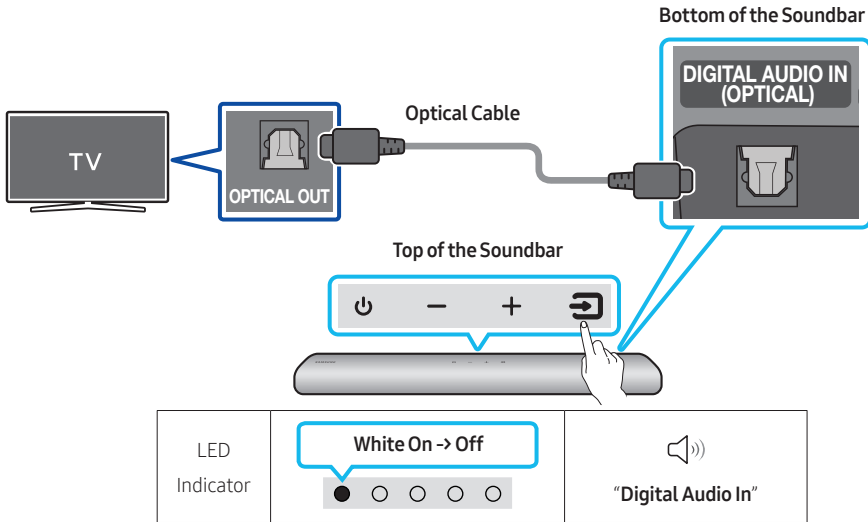

1. With the TV and Soundbar turned off, connect the **DIGITAL AUDIO IN (OPTICAL)** port on the Soundbar and the **OPTICAL** output port on the TV with the optical cable, as shown in the figure.
2. Turn on the Soundbar and TV.
3. Press the  (**Source**) button on the top panel or remote control, and then select the “**Digital Audio In**” mode.
4. The TV sound is output from the Soundbar.

06 USING A WIRELESS CONNECTION TO THE TV





Connecting via Bluetooth

When a Samsung TV is connected using Bluetooth, you can hear stereo sound without the hassle of cables.

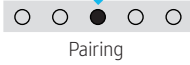

- Only one Samsung TV can be connected at a time.
- Samsung TV that supports Bluetooth can be connected.
Check the specifications of your TV.

The initial connection

<p>1. Bluetooth Pairing button</p>  <p>OR</p> <p>When in "Bluetooth" mode</p> 	<p>LED Indicator</p> <div data-bbox="420 582 744 710"><p>Red → Green → Blue Blinks</p><p>Pairing</p></div> <p>→</p> <div data-bbox="806 582 1013 710"><p>Cyan Blinks X3</p><p>Connection is complete</p></div> <ul style="list-style-type: none">• Until pairing is complete, the Multicolor LED changes as Red → Green → Blue in turn. <table border="1" data-bbox="431 821 1036 893"><tr><td data-bbox="431 821 487 893"></td><td data-bbox="487 821 733 893">"Ready to connect via Bluetooth."</td><td data-bbox="733 821 1036 893">"Ding" Short Sound.</td></tr></table>		"Ready to connect via Bluetooth."	"Ding" Short Sound.
	"Ready to connect via Bluetooth."	"Ding" Short Sound.		

2. Select Bluetooth mode on the Samsung TV.
(e.g. Home (🏠) → Settings (⚙️) → Sound → Sound Output → Bluetooth Speaker List → [AV] Samsung Soundbar S4T-Series (Bluetooth))
3. Select **"[AV] Samsung Soundbar S4T-Series"** from the list on TV's screen.
An available Soundbar is indicated with **"Need Pairing"** or **"Paired"** on the TV's Bluetooth device list. To connect the Samsung TV to the Soundbar, select the message, and then establish a connection.
4. You can now hear Samsung TV sound from the Soundbar.
 - If there is a connection log between the Soundbar and Samsung TV, the Soundbar is automatically connected by changing its mode to **"Bluetooth"**.

If the device fails to connect

- If you have an existing Soundbar (e.g., **[AV] Samsung Soundbar S4T-Series**) on the list of speakers on the Samsung TV, delete it.
- Then repeat steps 1 through 3.

Disconnecting the Soundbar from the Samsung TV

Press the  (**Source**) button on the top panel or on the remote control to select the mode other than “**Bluetooth**”.

- Disconnecting takes time because the Samsung TV must receive a response from the Soundbar. (The time required may differ, depending on the Samsung TV model.)

Notes on Bluetooth connection

- Locate a new device within 3.28 ft (1 m) to connect via Bluetooth communication.
- If asked for a PIN code when connecting a Bluetooth device, enter <0000>.
- The Soundbar automatically turns off after 20 minutes in the Ready state.
- The Soundbar may not perform Bluetooth search or connection correctly under the following circumstances:
 - If there is a strong electrical field around the Soundbar.
 - If several Bluetooth devices are simultaneously paired with the Soundbar.
 - If the Bluetooth device is turned off, not in place, or malfunctions.
- Electronic devices may cause radio interference. Devices that generate electromagnetic waves must be kept away from the Soundbar main unit - e.g., microwaves, wireless LAN devices, etc.

07 CONNECTING AN EXTERNAL DEVICE

Connecting using an Optical Cable

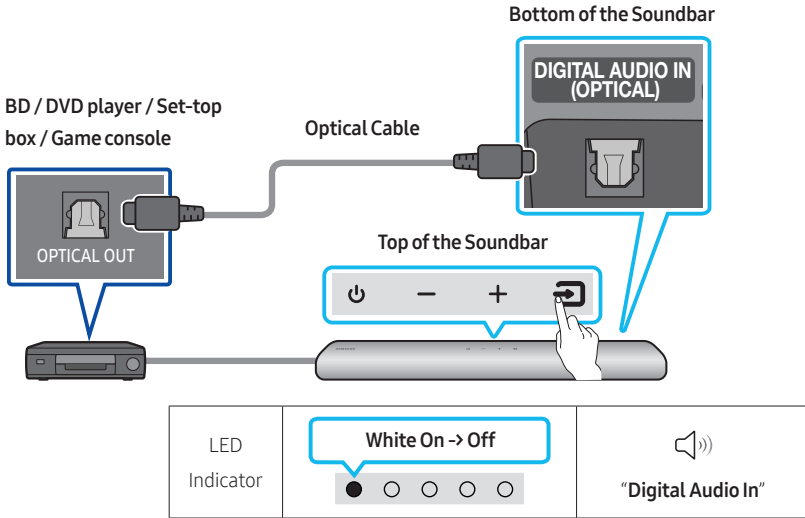

1. With the external device and Soundbar turned off, connect the **DIGITAL AUDIO IN (OPTICAL)** port on the Soundbar and the OPTICAL output port on the external device with the optical cable, as shown in the figure.
2. Turn on the Soundbar and external device.
3. Press the  (**Source**) button on the top panel or remote control, and then select the "**Digital Audio In**" mode.
4. The external device sound is output from the Soundbar.

08 CONNECTING A MOBILE DEVICE

Connecting via Bluetooth

When a mobile device is connected using Bluetooth, you can hear stereo sound without the hassle of cables.





- When you connect a paired Bluetooth device with the Soundbar off, the Soundbar automatically turns on.



mobile device

The initial connection

- When connecting to a new Bluetooth device, make sure the device is within 3.28 ft (1 m) distance.

<p>1. Bluetooth Pairing button</p>  <p>OR</p> <p>When in "Bluetooth" mode</p> 	<p>LED Indicator</p> <div data-bbox="423 579 744 699"><p>Red → Green → Blue Blinks</p><p>Pairing</p></div> <p>→</p> <div data-bbox="809 579 1013 699"><p>Cyan Blinks X3</p><p>Connection is complete</p></div> <ul style="list-style-type: none">• Until pairing is complete, the Multicolor LED changes as Red → Green → Blue in turn.	
	 <p>"Ready to connect via Bluetooth."</p>	<p>"Ding" Short Sound.</p>

2. On your device, select **"[AV] Samsung Soundbar S4T-Series"** from the list that appears.
3. Play music files from the device connected via Bluetooth through the Soundbar.

If the device fails to connect

- If you have an existing Soundbar (e.g., **[AV] Samsung Soundbar S4T-Series**) on the list of speakers on the Mobile device, delete it.
- Then repeat steps 1 and 2.

Notes on Bluetooth connection

- Locate a new device within 3.28 ft (1 m) to connect via Bluetooth communication.
- If asked for a PIN code when connecting a Bluetooth device, enter <0000>.
- The Soundbar automatically turns off after 20 minutes in the Ready state.
- The Soundbar may not perform Bluetooth search or connection correctly under the following circumstances:
 - If there is a strong electrical field around the Soundbar.
 - If several Bluetooth devices are simultaneously paired with the Soundbar.
 - If the Bluetooth device is turned off, not in place, or malfunctions.
- Electronic devices may cause radio interference. Devices that generate electromagnetic waves must be kept away from the Soundbar main unit - e.g., microwaves, wireless LAN devices, etc.
- The Soundbar supports SBC data (44.1kHz, 48kHz).
- Connect only to a Bluetooth device that supports the A2DP (AV) function.
- You cannot connect the Soundbar to a Bluetooth device that supports only the HF (Hands Free) function.
- When connecting the Soundbar to a Bluetooth device, place them as close to each other as possible.
- The farther the Soundbar and Bluetooth device are from each other, the lower the sound quality will become.

The Bluetooth connection may break when the devices are out of the effective range.

- The Bluetooth connection may not function as intended in areas with poor reception.
- A Bluetooth device may experience noise or malfunction under in the following conditions:
 - When the body is in contact with the signal transceiver on the Bluetooth device or Soundbar
 - In corners or when there is an obstacle in proximity, such as a wall or partition, where electrical changes may occur.
 - When exposed to radio interferences by other products operating on the same frequency ranges, such as medical equipment, microwave ovens, and wireless LAN devices.
 - Obstacles such as doors and walls may still impact the sound quality even when the devices are within the effective range.
- Note that your Soundbar cannot be paired with other Bluetooth devices while using the Bluetooth option.
- This wireless device may cause electrical interference during operation.

Disconnecting the Bluetooth device from a Soundbar

You can disconnect a Bluetooth device from the Soundbar. For instructions, see the Bluetooth device's user manual.

- The Soundbar will be disconnected.
- If the Soundbar is disconnected from the Bluetooth device, the multicolor LED indicator on the Soundbar blinks "**Red**" three times.

Disconnecting the Soundbar from the Bluetooth device

Press the  (**Source**) button on the top panel or on the remote control to select the mode other than "**Bluetooth**".

- Disconnecting takes time because the Bluetooth device must receive a response from the Soundbar. (Disconnection time may differ, depending on the Bluetooth device)
- If the Soundbar is disconnected from the Bluetooth device, the multicolor LED indicator on the Soundbar blinks "**Red**" three times.

Bluetooth Multi connection

The Soundbar can be connected to 2 Bluetooth devices at the same time.



1. Connect the Soundbar to up to two Bluetooth devices. (See page 20)
2. Play music from one of the connected Bluetooth devices while two devices are connected.
3. To play music from the Bluetooth device "B" while playing from the device "A", pause or stop playback on the device "A" and then start playing on the device "B".
 - The device won't switch if playing music from the device "B" without pausing or stopping the device "A" first.

Bluetooth Multi Pairing

How to pair multiple devices to the Soundbar

1. Turn on the Soundbar.
2. On any source, press and hold the  (**Source**) button on the top of the Soundbar for more than 5 seconds for the Soundbar to go into "**Bluetooth Pairing**" mode, then on the Bluetooth device side, switch Bluetooth on, and select the Soundbar from the list of available devices, the Soundbar will automatically connect to the Bluetooth device.
3. A 2nd Bluetooth device can be paired and connected to the Soundbar using the same method. If you attempt to connect a 3rd device, a connected device that is not playing audio will lose its Bluetooth connection, but will still be paired with the Soundbar.
4. Using the same method, you can pair up to 8 Bluetooth devices, but only the last 2 will stay connected to the Soundbar at the same time.

NOTES

- Only 1 Samsung TV, or 2 Bluetooth devices can be connected to the Soundbar at one time.
- The Soundbar will be disconnected from Bluetooth devices when it receives a connection request from a Samsung TV.

Using Tap Sound

Tap the Soundbar with your mobile device to play audio from the mobile device through the Soundbar.

- This function may not be supported, depending on the mobile device.
- This function is only compatible on Samsung mobile devices with Android 8.1 or later.

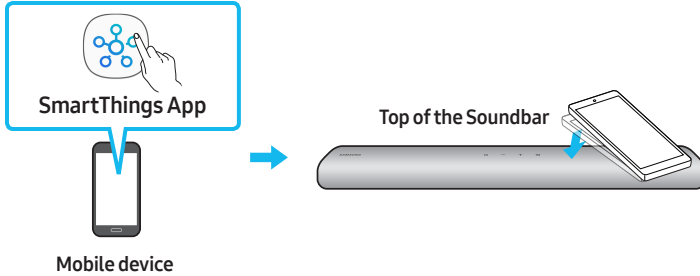

1. Turn on the **Tap Sound** function on your mobile device.
 - For details on how to turn on the function, refer to "**Setting the Tap Sound function**" below.
2. Tap the Soundbar with the mobile device. Select "**Start now**" in the displayed message window. A connection is established between the mobile device and Soundbar via Bluetooth.
3. Play audio from the mobile device through the Soundbar.
 - This function connects a mobile device to the Soundbar via Bluetooth by detecting vibration that occurs when the device touches the Soundbar.
 - Make sure the mobile device does not tap a sharp corner of the Soundbar. The Soundbar or mobile device may become scratched or damaged.
 - It is recommended that the mobile device be covered with a case. Lightly tap the wide area in the upper portion of the Soundbar, without using excessive force.
 - To use this function, update the **SmartThings** app to the latest version. The function may not be supported, depending on the app version.

Setting the Tap Sound function

Use the **SmartThings** app to turn on the **Tap View, Tap Sound** function.

1. On the mobile device, run the **SmartThings** app.
2. Select (☰ → ⚙️) in the **SmartThings** app screen displayed on the mobile device.
3. Set "**Tap View, Tap Sound**" to On to allow the function to work when a mobile device moves close to the Soundbar.

NOTES

- When the mobile device is in power-saving mode, the **Tap Sound** function does not work.
- The **Tap Sound** function may not work if there are devices near the Soundbar that cause radio interference such as electric devices. Make sure devices that may cause radio interference are placed at a sufficient distance away from the Soundbar.

09 INSTALLING ON A WALL

Samsung Electronics do not provide the wall mount.

You can purchase a wall mount separately to install the speaker on a wall if you want.

Considerations for purchasing

- Endurable load : Above 16.8lbs (7.6kg)
- Hole size : M4 - 10 threaded insert

NOTES

- Since Wall-mount installation is optional, you must purchase the corresponding accessories separately.
- Check the strength of the wall before you install the Wall Mount Bracket. If the strength is insufficient, make sure to reinforce the wall before installing the Wall Mount Bracket and the speaker on the wall.
- Samsung Electronics is not liable for any damage to the product due to the product being installed inappropriately.
- Please beware not to install the speaker being laid down or turned upside down.

10 INSTALLING THE SOUNDBAR IN FRONT OF TV

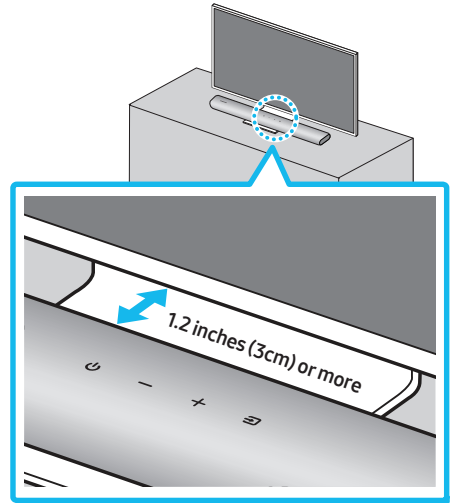

Align the center of the Soundbar to the center of the TV as illustrated in the image.

Place the Soundbar at least 1.2 inches (3cm) away from the TV.

NOTES

- Make sure the Soundbar is placed on a flat and solid surface.
- Insufficient gap from the TV may cause acoustic problems.

11 SOFTWARE UPDATE

Important: The update function erases all user settings. We recommend you write down your settings so that you can easily reset them after the update.

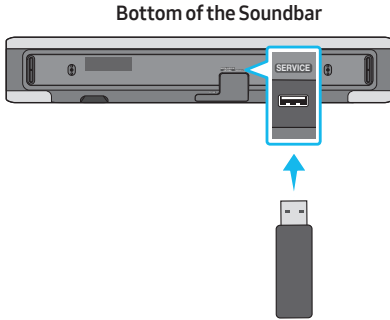

1. Connect a USB thumb drive to your computer.
Important: Make sure there are no music files on the USB thumb drive. This may cause the firmware update to fail.
2. Go to the Samsung website at <https://www.samsung.com/us/support/downloads/> on your computer → select Enter Model Number and enter the model of your Soundbar. Select manuals and downloads and download the latest software file.
3. Save the downloaded software to a USB stick and select "Extract Here" to unzip the folder.
4. Turn on the Soundbar and connect the USB stick containing the software update to the **SERVICE** port.

5. Turn on the Soundbar Within 3 minutes, the 5 LED cycle sequence flashing and updating begins. The 5 LEDs will all light up white, the 5 LEDs begin to flash in sequence again. When the update is complete, the Soundbar will automatically restart.

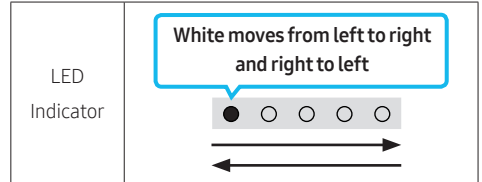

- This product has a DUAL BOOT function. If the firmware fails to update, you can update the firmware again.

If LED sequence flashing is not displayed

1. Turn off the Soundbar, disconnect and then reconnect the USB storage device that contains the update files to the Soundbar's **SERVICE** port.
2. Disconnect the Soundbar's power cord, reconnect it, and then turn on the Soundbar.

NOTES

- The firmware update may not work properly if audio files supported by the Soundbar are stored in the USB storage device.
- Do not disconnect the power or remove the USB device while updates are being applied. The main unit will turn off automatically after completing the firmware update.
- After the update is completed, the user setup in the Soundbar is initialized so you can reset your settings. We recommend you write down your settings so that you can easily reset them after the update. If the software update fails, check if the USB stick is defective.
- Mac OS users should use MS-DOS (FAT) as the USB format.
- Updating via USB may not be available, depending on the USB storage device manufacturer.

Initialization

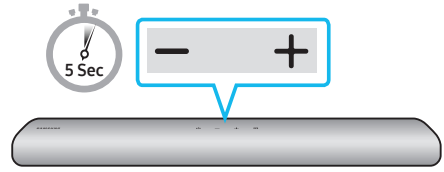

With the Soundbar on, press the **- + (Volume)** buttons on the body at the same time for at least 5 seconds. The LED display changes as shown below and then the Soundbar is initialized.

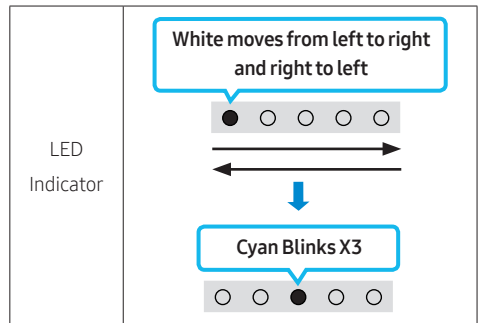

⚠ CAUTION

- All the settings of the Soundbar are initialized. Be sure to perform this only when initialization is required.

12 TROUBLESHOOTING

Refer to the instructions below if this product does not function properly. If the problem you are experiencing is not listed below or if the instructions below do not help, turn off the product, disconnect the power cord, and contact Samsung Electronics at 1-800-SAMSUNG (1-800-726-7864).

In case the power is not turned on

- Make sure the power cord of the Soundbar is correctly inserted into the outlet.

In case the functions do not work properly

- After removing the power cord, insert it again.
- Remove the power cord from the external device and try again.
- If there is no signal, the Soundbar automatically turns off after a certain period of time. Turn on the power.

In case the remote control does not work



- Make sure the remote is within range of the soundbar.
- Replace the batteries with new ones.

In case the Soundbar sound is not output

- The volume of the Soundbar is too low or muted. Adjust the volume.
- When any external device (STB, Bluetooth device, mobile device, etc.) is connected, adjust the volume of the external device.
- For sound output of the TV, select Soundbar. (Samsung TV: Home (🏠) → Settings (⚙️) → Sound → Sound Output → Select Soundbar)

- The cable connection to the Soundbar may not be loose. Remove the cable and connect again.
- Remove the power cord completely, reconnect, and turn the power on.
- Initialize the product and try again. (See page 27.)

In case Bluetooth connection is not possible

- When connecting a new device, switch to Bluetooth Pairing for connection. (Press the  PAIR button on the remote control or press the  (Source) button on the body for at least 5 seconds.)
- If the Soundbar is connected to another device, disconnect that device first to switch the device.
- Reconnect it after removing the Bluetooth speaker list on the device to connect. (Samsung TV: Home (🏠) → Settings (⚙️) → Sound → Sound Output → Bluetooth Speaker List)
- Remove and reconnect the power plug, then try again.
- Initialize the product and try again. (See page 27.)

In case Bluetooth sound breaking occurs

- Sounds may be breaking due to interference by radio frequency or electronic devices nearby. Keep such devices away from the Soundbar to avoid radio interference. Example: microwave ovens.
- Because the device to connect is far away from the Soundbar, sound breaking may occur. Move the device near the Soundbar.
- If a part of your body is in contact with the Bluetooth transceiver or the product is installed on metal furniture, sound breaking may occur. Check the installation environment and conditions for use.

In case the Soundbar is not turned on as soon as the TV is turned on

- When you turn off the Soundbar while watching TV, power synchronization with the TV is disabled. First turn off the TV.

13 LICENSE



Manufactured under license from Dolby Laboratories. Dolby, Dolby Audio, and the double-D symbol are trademarks of Dolby Laboratories.



For DTS patents, see <http://patents.dts.com>. Manufactured under license from DTS, Inc. DTS, the Symbol, DTS in combination with the Symbol, and DTS 2.0 Channel are registered trademarks or trademarks of DTS, Inc. in the United States and/or other countries. DTS, Inc. All Rights Reserved.



The Bluetooth® word mark and logos are registered trademarks owned by the Bluetooth SIG, Inc. and any use of such marks by Samsung Electronics Co., Ltd. is under license. Other trademarks and trade names are those of their respective owners.

14 OPEN SOURCE LICENSE NOTICE

To send inquiries and requests for questions regarding open sources, contact Samsung Open Source (<http://opensource.samsung.com>)

15 IMPORTANT NOTES ABOUT SERVICE

- Figures and illustrations in this User Manual are provided for reference only and may differ from actual product appearance.
- An administration fee may be charged if either:
 - a. An engineer is called out to your home at your request and there is no defect in the product.
 - b. You bring the unit to a repair center and there is no defect in the product.
- You will be advised of the amount of the administration fee before any work is done or a home visit is made.
- If you have a problem with this product, we strongly recommend you read the appropriate section of this manual, visit the Support page for your product at www.samsung.com, or call Samsung Product Support (1-800-726-7864) to find an answer before you contact a service center for a repair.

16 SPECIFICATIONS AND GUIDE

Specifications

Model Name	HW-S40T / S41T
Weight	4.2 lbs (1.9 kg)
Dimensions (W x H x D)	26.8 x 2.7 x 4.5 inches (680.0 x 68.0 x 115.0 mm)
Operating Temperature Range	+41°F to +95°F (+5°C to +35°C)
Operating Humidity Range	10 % ~ 75 %
AMPLIFIER Rated Output power	(25W x 2) + (25W x 2)
Supported play formats (DTS 2.0 sound is played in DTS format.)	LPCM 2ch, Dolby Audio™ (supporting Dolby® Digital), DTS
Bluetooth Port deactivation method	Press and hold the SOUND MODE button for more than 5 seconds to turn off Bluetooth Power function.

NOTES

- Samsung Electronics Co., Ltd reserves the right to change the specifications without notice.
- Weight and dimensions are approximate.

LIMITED WARRANTY TO ORIGINAL PURCHASER

This SAMSUNG brand product, as supplied and distributed by SAMSUNG and delivered new, in the original carton to the original consumer purchaser, is warranted by SAMSUNG against manufacturing defects in materials and workmanship for a limited warranty period of:

One (1) Year Parts and Labor* **(*90 Days Parts and Labor for Commercial Use)**

This limited warranty begins on the original date of purchase, and is valid only on products purchased and used in the United States. To receive warranty service, the purchaser must contact SAMSUNG for problem determination and service procedures. Warranty service can only be performed by a SAMSUNG authorized service center. The original dated bill of sale must be presented upon request as proof of purchase to SAMSUNG or SAMSUNG's authorized service center. Transportation of the product to and from the service center is the responsibility of the purchaser. SAMSUNG will repair or replace this product, at our option and at no charge as stipulated herein, with new or reconditioned parts or products if found to be defective during the limited warranty period specified above. All replaced parts and products become the property of SAMSUNG and must be returned to SAMSUNG. Replacement parts and products assume the remaining original warranty, or ninety (90) days, whichever is longer. SAMSUNG's obligations with respect to software products distributed by SAMSUNG under the SAMSUNG brand name are set forth in the applicable end user license agreement. Non-SAMSUNG hardware and software products, if provided, are on an "AS IS" basis.

Non-SAMSUNG manufacturers, suppliers, publishers, and service providers may provide their own warranties. This limited warranty covers manufacturing defects in materials and workmanship encountered in normal, and except to the extent otherwise expressly provided for in this statement, noncommercial use of this product, and shall not apply to the following, including, but not limited to: damage which occurs in shipment; delivery and installation; applications and uses for which this product was not intended; altered product or serial numbers; cosmetic damage or exterior finish; accidents, abuse, neglect, fire, water, lightning or other acts of nature; use of products, equipment, systems, utilities, services, parts, supplies, accessories, applications, installations, repairs, external wiring or connectors not supplied and authorized by SAMSUNG, or which damage this product or result in service problems; incorrect electrical line voltage, fluctuations and surges; customer adjustments and failure to follow operating instructions, cleaning, maintenance and environmental instructions that are covered and prescribed in the instruction book; product removal or reinstallation; reception problems and distortion related to noise, echo, interference or other signal transmission and delivery problems. SAMSUNG does not warrant uninterrupted or error-free operation of the product.

THERE ARE NO EXPRESS WARRANTIES OTHER THAN THOSE LISTED AND DESCRIBED ABOVE, AND NO WARRANTIES WHETHER EXPRESS OR IMPLIED, INCLUDING, BUT NOT LIMITED TO, ANY IMPLIED WARRANTIES OF MERCHANTABILITY OR FITNESS FOR A PARTICULAR PURPOSE, SHALL APPLY AFTER THE EXPRESS WARRANTY PERIODS STATED ABOVE, AND NO OTHER EXPRESS WARRANTY OR GUARANTY GIVEN BY ANY PERSON, FIRM OR CORPORATION WITH RESPECT TO THIS PRODUCT SHALL BE BINDING ON SAMSUNG. SAMSUNG SHALL NOT BE LIABLE FOR LOSS OF REVENUE OR PROFITS, FAILURE TO REALIZE SAVINGS OR OTHER BENEFITS, OR ANY OTHER SPECIAL, INCIDENTAL OR CONSEQUENTIAL DAMAGES CAUSED BY THE USE, MISUSE OR INABILITY TO USE THIS PRODUCT, REGARDLESS OF THE LEGAL THEORY ON WHICH THE CLAIM IS BASED, AND EVEN IF SAMSUNG HAS BEEN ADVISED OF THE POSSIBILITY OF SUCH DAMAGES. NOR SHALL RECOVERY OF ANY KIND AGAINST SAMSUNG BE GREATER IN AMOUNT THAN THE PURCHASE PRICE OF THE PRODUCT SOLD BY SAMSUNG AND CAUSING THE ALLEGED DAMAGE. WITHOUT LIMITING THE FOREGOING, PURCHASER ASSUMES ALL RISK AND LIABILITY FOR LOSS, DAMAGE OR INJURY TO PURCHASER AND PURCHASER'S PROPERTY AND TO OTHERS AND THEIR PROPERTY ARISING OUT OF THE USE, MISUSE OR INABILITY TO USE THIS PRODUCT SOLD BY SAMSUNG NOT CAUSED DIRECTLY BY THE NEGLIGENCE OF SAMSUNG. THIS LIMITED WARRANTY SHALL NOT EXTEND TO ANYONE OTHER THAN THE ORIGINAL PURCHASER OF THIS PRODUCT, IS NONTRANSFERABLE AND STATES YOUR EXCLUSIVE REMEDY.

Some states do not allow limitations on how long an implied warranty lasts, or the exclusion or limitation of incidental or consequential damages, so the above limitations or exclusions may not apply to you. This warranty gives you specific legal rights, and you may also have other rights which vary from state to state.

To obtain warranty service, please contact SAMSUNG customer care center.

The benefits of this Limited Warranty extend only to the original purchaser of Samsung products from an authorized Samsung reseller. THIS LIMITED WARRANTY SHALL NOT APPLY TO ANY SAMSUNG PRODUCTS PURCHASED FROM UNAUTHORIZED RESELLERS OR RETAILERS, EXCEPT IN STATES WHERE SUCH RESTRICTION MAY BE PROHIBITED. For a list of Samsung authorized retailers, please go to:

http://www.samsung.com/us/peaceofmind/authorized_resellers.html.

SAMSUNG



Certification model only

QUESTIONS OR COMMENTS?

AREA	CALL	OR VISIT US ONLINE AT	WRITE
IN THE US	1-800-SAMSUNG (726-7864)	www.samsung.com/us/support	Samsung Electronics America, Inc. 85 Challenger Road Ridgefield Park, NJ 07660

© 2020 Samsung Electronics Co., Ltd. All rights reserved.