



SMART Board® GX (V3) series interactive displays

Installation and maintenance guide

SBID-GX165-V3 | SBID-GX175-V3 | SBID-GX186-V3
IDGX65-2 | IDGX75-2 | IDGX86-2



Was this document helpful?
smarttech.com/docfeedback/171903

SMART®

Learn more



This guide and other resources for SMART Board (V3) series interactive displays are available in the Support section of the SMART website (smarttech.com/support). Scan this QR code to view these resources on your mobile device.



ENERGY STAR is the government-backed symbol for energy efficiency, providing simple, credible, and unbiased information that consumers and businesses rely on to make well-informed decisions. ENERGY STAR-certified products are the simple choice for energy efficiency, making it easy for consumers and businesses to make purchases that save them money and protect the environment. The U.S. EPA ensures that each product that earns the label is independently certified to deliver the quality, performance, and savings that users have come to expect.

As shipped, your display delivers ENERGY STAR performance and savings. However, changing some settings may increase energy consumption beyond the limits required for ENERGY STAR certification. For example, increased brightness and contrast will increase power consumption.

Please consider the environment when you choose non-ENERGY STAR settings.

Licenses

The terms HDMI, HDMI High-Definition Multimedia Interface, HDMI trade dress and the HDMI Logos are trademarks or registered trademarks of HDMI Licensing Administrator, Inc.



The Bluetooth word mark is owned by the Bluetooth SIG, Inc. and any use of such marks by SMART Technologies ULC is under license.

Trademark notice

SMART Board, SMART Notebook, SMART TeamWorks, SMART Meeting Pro, Object Awareness, Silktouch, smarttech, the SMART logo and all SMART taglines are trademarks or registered trademarks of SMART Technologies ULC in the U.S. and/or other countries. The Bluetooth word mark is owned by the Bluetooth SIG, Inc. and any use of such marks by SMART Technologies ULC is under license. The Adopted Trademarks HDMI, HDMI High-Definition Multimedia Interface, and the HDMI Logo are trademarks or registered trademarks of HDMI Licensing Administrator, Inc. in the United States and other countries. Microsoft and Windows are either registered trademarks or trademarks of Microsoft Corporation in the United States and/or other countries. All other third-party product and company names may be trademarks of their respective owners.

Copyright notice

© 2024 SMART Technologies ULC. All rights reserved. No part of this publication may be reproduced, transmitted, transcribed, stored in a retrieval system or translated into any language in any form by any means without the prior written consent of SMART Technologies ULC. Information in this manual is subject to change without notice and does not represent a commitment on the part of SMART.

This product and/or use thereof is covered by one or more of the following U.S. patents:

www.smarttech.com/patents

August 26, 2024

Important information

Warning

- Failure to follow the installation instructions included with the display could result in injury and product damage which may not be covered by the warranty.
- Do not open or disassemble the display. You risk electrical shock from the high voltage inside the casing. Opening the casing also voids the warranty.
- Do not stand (or allow children to stand) on a chair to touch the surface of the display. Rather, mount the product at the appropriate height.
- To reduce the risk of fire or electric shock, do not expose the display to rain or moisture.
- If the display requires replacement parts, make sure the service technician uses replacement parts specified by SMART Technologies or parts with the same characteristics as the original.
- Ensure that any cables that cross the floor to the display are properly bundled and marked to avoid a trip hazard.
- Do not insert objects inside the cabinet ventilation holes, because they could touch dangerous voltage points and cause electric shock, fire, or product damage which may not be covered by the warranty.
- Do not place heavy objects on the power cable. Damage to the cable could cause shock, fire, or product damage which may not be covered by the warranty.
- Use only extension cords and outlets that can fully accommodate the display's polarized plug.
- Use the power cable provided with the display. If a power cable is not supplied, contact your supplier. Use only power cables that match the AC voltage of the power outlet and that comply with your country's safety standards.
- If the glass is broken, do not touch the liquid crystal. To prevent injury, handle glass fragments with care when disposing of them.
- Do not move or mount the display by connecting rope or wire to its handles. The display is heavy, and failure of the rope, wire, or handle could lead to injury.

Important information

- **Stability Hazard:** The display may fall, causing serious personal injury or death. To prevent injury, the display must be securely mounted to the wall in accordance with the installation instructions and using the mounting hardware provided by SMART (if supplied). If your display does not include mounting hardware, be sure to select mounting hardware that is rated or certified for the display's size and weight and is compatible with the surface to which you're mounting the display.
- Use only VESA®-compliant mounts.
- Disconnect the display's power cable from the wall outlet and seek assistance from qualified service personnel if any of the following occur:
 - The power cable or plug is damaged
 - Liquid is spilled into the display
 - Objects fall into the display
 - The display is dropped
 - Structural damage, such as cracking, occurs
 - The display behaves unexpectedly when you follow operating instructions
- This product may contain substances that are candidate SVHCs under the EU REACH Regulation (EC) 1907/2006.

See > echa.europa.eu/scip-database

Caution

- Turn off the display before cleaning its screen. Otherwise, you may scramble the desktop icons or inadvertently activate applications when you wipe the screen.
- Avoid setting up and using the display in an area with excessive levels of dust, humidity, and smoke.
- Make sure an electrical socket is near the display and remains easily accessible during use.
- In Europe, the display should be used only with European TN and TT power distribution systems.

It is not suitable for older, IT-type power distribution systems found in some European countries. "This system (IT-type) is widely used isolated from earth, in some installations in France, with impedance to earth, at 230/400V, and in Norway, with voltage limiter, neutral not distributed, at 230V line-to-line."

Contact qualified personnel if you're uncertain of the type of power system available where you're installing the display.

- The accessory slot's maximum available power is 90 W. The slot is not a limited power source. To reduce the risk of fire, make sure that accessories connecting to the slot satisfy the fire enclosure requirements of IEC 62368-1.

Important information

- You must connect the USB cable that came with the display to a computer that has a USB compliant interface and that bears the USB logo. In addition, the USB source computer must be compliant with IEC 62368-1. The source computer must be CE marked and carry safety certification marks for Canada and USA. This is for operating safety and to avoid damage to the display.
- Prolonged focus on a fixed object, such as a display's screen, can contribute to eye strain and headaches. To protect eye health, follow the 20-20-20 rule: after 20 minutes of screen time, spend 20 seconds looking at something 20 feet (6 meters) away. Relaxing the eyes, looking around frequently, and blinking will also help prevent eye strain and fatigue.
- Only SMART-provided OPS appliances are supported in SMART Board interactive displays. Third-party OPS appliances are not supported, and their use can lead to poor performance or damage to the display.
- Do not install or remove the OPS appliance while the display is turned on. First make sure the power switch on the back of the display beside the AC power inlet is in the OFF (O) position. If you can't reach the power switch, use the front control panel's power button  to put the display in Standby mode, and then unplug the display's power cable from the power outlet.
- After you have turned the display's power switch off or unplugged it, wait at least 30 seconds before removing the appliance to allow its internal power supplies to discharge completely. You might also wait five minutes to give the appliance the opportunity to cool, if necessary.
- Make sure the OPS appliance is secured to the display with screws through the two anchor points. Inadequately secured appliances can damage the display. (An OPS appliance's anchoring screws are typically captive, although some simply include separate anchoring screws.)

Important

The following table includes the normal operating power requirements for the display:

Models	Regulatory Models	Power requirements
GX165-V3	IDGX65-2	100V to 240V AC, 50 Hz to 60 Hz, 79 W
GX175-V3	IDGX75-2	100V to 240V AC, 50 Hz to 60 Hz, 88 W
GX186-V3	IDGX86-2	100V to 240V AC, 50 Hz to 60 Hz, 119 W

For additional requirements and other information, refer to the display's specifications (see *More information* on page 15).

Contents

Important information	3
Chapter 1 Welcome	8
About this guide	8
About the display	9
Identifying your specific model	13
Accessories	13
More information	15
Chapter 2 Installing the display	16
Moving the display to the installation site	16
Installing the display on a wall	18
Installing the display on a stand	23
Connecting to a network	23
Connecting power and turning on the display for the first time	26
Configuring the display's network settings	28
Chapter 3 Connecting computers and other devices	32
Installing SMART software	32
Connecting room computers and guest laptops	33
Connecting a SMART OPS PC module	43
Connecting other devices	44
Connector diagrams	49
Chapter 4 Maintaining the display	54
Turning the display on or off	54
Cleaning and maintaining the display	55
Updating system firmware	59
Chapter 5 Troubleshooting	61
Troubleshooting the display and related SMART products	61
Contacting your reseller for additional support	61
Appendix A Adjusting display settings	62
Accessing the display's settings	62
Exiting the display's settings	63
Network	63
Personalization	66
Input and output	67

Contents

Applications	69
System	70
Regulatory Information	75
About	75
Appendix B Adjusting Input settings	77
Opening the Input settings menu	77
Exiting the Input settings menu	77
Source settings	77
Advanced settings	78
Appendix C Managing the display using RS-232	82
Configuring the serial interface settings	83
Commands and responses	85
Power state commands	87
Input commands	88
Brightness commands	88
Freeze commands	89
Screen shade commands	89
Volume commands	89
Mute commands	89
Firmware version commands	90
Model number commands	90
Serial number commands	90
Part number commands	90
Asynchronous messages	90
Appendix D Enrolling the display in SMART Remote Management	92
Appendix E Disabling and reenabling the embedded OS and other inputs	93
Disabling inputs	93
Reenabling inputs	94
Certification and compliance	95

Chapter 1 **Welcome**

- About this guide 8
- About the display 9
 - Touch 9
 - Display10
 - Mounting hardware 10
 - Front control panel 10
 - Remote control and infrared sensor 10
 - Ambient light sensor 10
 - Power status 11
 - Writing, drawing, and erasing 11
 - Audio 11
 - Network connectivity 11
 - Front connector panel 11
 - Room computers and guest laptops 12
 - Tools and features 12
 - Accessory slot 12
- Identifying your specific model 13
- Accessories 13
 - SMART OPS PC module 14
 - Stands 14
 - USB extenders 14
- More information 15

The SMART Board® (V3) series interactive display gives you everything you need to get started with interactivity. This chapter introduces the features of your GX series display.

About this guide

- How to install the display
- How to connect power and devices
- How to turn on the display for the first time
- How to maintain the display for years of use
- How to troubleshoot issues with the display

This guide also includes information about the display's settings and support for remote management.

This guide is intended for those who install and maintain displays in their organizations. Additional documentation and resources are available for users of the display (see *More information* on page 15).

About the display

The SMART Board GX series gives you everything you need to get started with interactivity.

The display includes a comprehensive set of features and components.

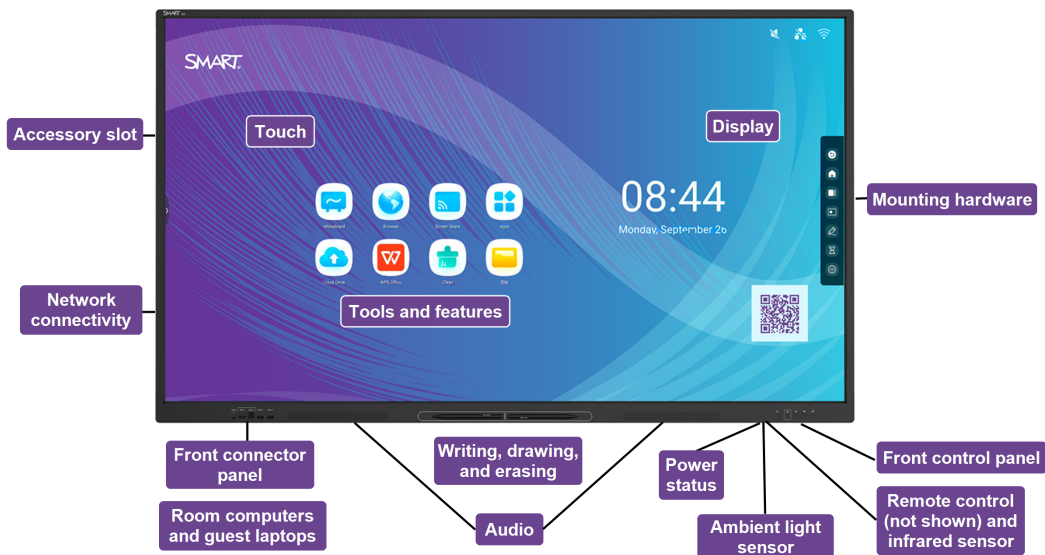

Touch

You can do everything on the display that you can do at your computer—open and close applications, meet with others, create new documents or edit existing ones, visit websites, play and manipulate videos, and so on—by touching the display's surface.

You can use an array of gestures within applications, including panning, scaling, rotating, and zooming in and out.

Display

The 4K ultra-high-definition LED display provides optimal image clarity and wide viewing angles.

The display size varies by model:

Models	Size (diagonal)
GX165-V3	65"
GX175-V3	75"
GX186-V3	86"

Mounting hardware

You can use VESA compliant wall mounts, such as SMART's WM-SBID-200 wall mount (not included), to mount the display on a wall (see *Installing the display on a wall* on page 18).

You can also mount the display on a mobile stand (see *Accessories* on page 13).

Front control panel

The front control panel provides buttons for turning the display on and off, controlling the volume, freezing the screen, and displaying the Home screen.

Remote control and infrared sensor

The display's infrared sensor is located in the control panel in the bottom-right corner of the display's frame.

You can use the remote control to turn the display on and off, adjust display settings, and so on.

Ambient light sensor

The ambient light sensor is located in the bottom-right corner of the display's frame. The sensor detects the brightness of the room and adjusts the screen's brightness accordingly.

To enable or disable this feature, go to **Input > Advanced settings > Screen > AutoLight** (see *Advanced settings* on page 78).

Note

The ambient light sensor is disabled by default.

Power status

See *SMART Board GX (V3) series interactive displays user's guide* (docs.smarttech.com/kb/171903).

Writing, drawing, and erasing

The display comes with two pens you can use to write or draw on the screen. Each end of a pen can be assigned to write or draw in a different color when using the Whiteboard app. You can erase digital ink by moving your fist or palm over the digital ink.

With Object Awareness¹, the display responds automatically to the tool or object you're using, whether it's a pen, finger, or palm.

Audio

The display includes two 20 W integrated speakers.

Network connectivity

The display requires a network and internet connection for downloading software and firmware updates. Some applications also require a network and internet connection (for example, the web browser).

The display requires a network and internet connection for downloading software and firmware updates.

You can connect the display to a network using Wi-Fi or an Ethernet cable.

- The Wi-Fi module supports both 2.4 and 5 GHz bands.
- The two RJ45 jacks allow you to connect the display and an external device, such as a computer, to an Ethernet network.

See > *Connecting to a network* on page 23

Front connector panel

The front connector panel includes connectors for USB peripherals and a computer or other input.

See > *Connecting room computers and guest laptops* on page 33

¹When connected to a computer with SMART Product Drivers

See > *Connecting other devices* on page 44

Room computers and guest laptops

You can connect room computers and guest laptops to the display and view and interact with them.

The display comes with SMART software that you can install on connected computers to take full advantage of the display's features.

See > *Connecting room computers and guest laptops* on page 33

Tools and features

The display's built-in Android™ computing provides apps that enable you to browse the web, use a whiteboard, share your screen, and more without using a connected device.

Accessory slot

You can install an OPS-compatible device, such as a SMART OPS PC module, in the accessory slot. SMART OPS PC modules provide a complete Windows® Pro installation.

See > *SMART OPS PC module* on page 14

Caution

- The accessory slot's maximum available power is 90 W. The slot is not a limited power source. To reduce the risk of fire, make sure that accessories connecting to the slot satisfy the fire enclosure requirements of IEC 62368-1.
- Do not remove the OPS PC or other devices from the accessory slot while they are turned on.
- Only SMART-provided OPS appliances are supported in SMART Board interactive displays. Third-party OPS appliances are not supported, and their use can lead to poor performance or damage to the display.
- Do not install or remove the OPS appliance while the display is turned on. First make sure the power switch on the back of the display beside the AC power inlet is in the OFF (O) position. If you can't reach the power switch, use the front control panel's power button  to put the display in Standby mode, and then unplug the display's power cable from the power outlet.
- After you have turned the display's power switch off or unplugged it, wait at least 30 seconds before removing the appliance to allow its internal power supplies to discharge completely. You might also wait five minutes to give the appliance the opportunity to cool, if necessary.

- Make sure the OPS appliance is secured to the display with screws through the two anchor points. Inadequately secured appliances can damage the display. (An OPS appliance's anchoring screws are typically captive, although some simply include separate anchoring screws.)

Identifying your specific model

SMART offers several models of the SMART Board GX (V3) series interactive displays.

For help identifying your model, see the labels on the back or left side of the display.

Tip

The label features the display's base model number (for example, SBID-GX075-V3). Please note this number is different from the actual model/SKU number (for example GX175-V3).

Model	Screen size (approximate)
GX165-V3	65" (165 cm)
GX175-V3	75" (190 cm)
GX186-V3	86" (218 cm)

Accessories

Accessories for the display include:

- SMART OPS PC module
- SMART wall mount (WM-SBID-200) for SMART Board displays
- Stands
- USB extenders

See also > [smarttech.com/accessories](https://www.smarttech.com/accessories)

SMART OPS PC module

SMART Open Pluggable Specification (OPS) PC modules provide a hassle-free Windows Pro installation based on Intel® Core™ processors and are designed specifically to work with a SMART Board interactive display. All OPS PC modules are fully licensed with Windows Pro. Install the OPS PC module in a display's accessory slot to provide a complete 4K UHD Windows installation at your fingertips, without the need for an external PC or additional cables.

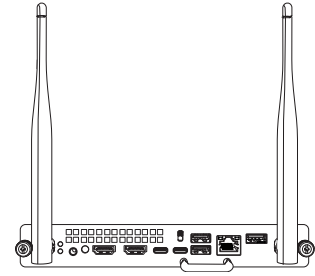

Install familiar Windows applications, such as SMART Notebook®, SMART TeamWorks™, and SMART Meeting Pro® software, and access the internet directly through your display's network connection. Upgrades and service for the OPS PC module are easy to perform without removing the display from its mounting.

Stands

If you want to move the display from place to place, you can install it on a SMART mobile stand. If you are installing the display on a wall that cannot support the display's full weight, you can install the display on a SMART floor stand.

Notes

- If you want to use the 75" and 86" models (GX175-V3 and GX186-V3) with one of SMART's electric height-adjustable stands, you must first attach a SMART wall mount (model WM-SBID-200, part #1031766, docs.smarttech.com/kb/171405) to the display before mounting the display to the stand. (This applies to the FSE-400, FSE-410, and FSE-420 models of mobile stand and the WSE-400 and WSE-410 models of wall stand).
- For users in Australia and New Zealand: SMART does not provide stands for use in Australia and New Zealand, nor can we provide recommendations for stands from other vendors.

USB extenders

As noted in the display's specifications, the USB connection between the display and computer should be no longer than 16' (5 m). If you need to connect a computer that is more than 16' (5 m) from the display, use the following USB extender:

Extender	Specifications
USB-XT	docs.smarttech.com/kb/119318

See also > [Extending USB cables](#)

More information

SMART provides a variety of other documents for this display in the Support section of the SMART website (smarttech.com/support). Scan the QR code on this guide's cover for links to SMART Board GX (V3) series interactive display documents and other support resources.

Chapter 2 Installing the display

Moving the display to the installation site	16
Using transportation aides	17
Accommodating doorways, hallways, and elevators	17
Dealing with cracked, chipped, or shattered glass	18
Saving the original packaging	18
Installing the display on a wall	18
Choosing a location	19
Choosing a height	21
Assessing the wall	21
Selecting mounting hardware	22
Selecting a wall mount	22
Mounting the display	22
Installing the display on a stand	23
Using SMART mobile stands	23
Using a third-party stand	23
Connecting to a network	23
Configuring network settings	23
Connecting to a network	25
Connecting power and turning on the display for the first time	26
Configuring the display's network settings	28

SMART recommends that only trained installers install the display.

This chapter is for installers. Installers should read this information and the installation instructions included with the display before they begin the installation.

Warning

Improper installation of the display can result in injury and product damage.

Moving the display to the installation site

After your organization receives the display, you need to move it to the place where you plan to install it.

On occasion, you might also need to move the display to another location after installing it initially.

Important

- Move the display at your own risk. SMART cannot accept liability for damages or injury that occur during the display's transportation.
- When moving the display:
 - Follow local safety regulations and standards.
 - Pack the display in its original packaging, including the pallet.
 - Move the display so that its top frame faces up.
 - Do not place an unpacked display on its side.
 - Have at least two people move the display.

Tip

display packaging may be labeled to indicate which side is the front. Look for "FRONT" on the packaging to help orient the box during transportation.

Using transportation aides

You can use the following aides to move the display:

- Cart
- Furniture dolly
- Mechanical lift

Accommodating doorways, hallways, and elevators

In some situations, you might need to remove the display from its packaging to move it through narrow doorways or hallways or onto an elevator. In these situations, keep the foam pieces on the bottom corners of the display. These foam pieces protect the display if you need to set it down during transportation.

You might also need to rotate the display so that its top frame faces to the side. You can do this during transportation, but when you install the display, it must be in landscape orientation (with the top frame facing up). Do not place an unpacked display on its side.

Dealing with cracked, chipped, or shattered glass

The display contains safety-tempered glass. Although this glass is heat-strengthened to help withstand impacts, the glass can crack, chip, or shatter if struck with enough force. (Safety glass is designed to break into small pieces rather than sharp shards if it is broken.) Temperature changes can cause a minor crack or chip to become worse, possibly causing the glass to shatter.

See > [Shattered glass on an interactive display](#)

If the display's glass is cracked or chipped, have it professionally inspected and repaired at a SMART authorized repair center. If the display's glass shatters, carefully clean up the area and have the display repaired or replaced.

Warning

For safety and to prevent further damage, do not continue to install or use the display if its glass is cracked, chipped or shattered.

Saving the original packaging

Save the original packaging, including the display's pallet, and repack the display with as much of it as possible if you ever need to move the display after installation. This packaging was designed to provide the best possible protection against shock and vibration.

Note

If the original packaging isn't available, you can purchase the same packaging directly from your authorized SMART reseller (smarttech.com/where).

Caution

Move the display only in the original packaging or replacement packaging purchased from your authorized SMART reseller. Moving the display without correct packaging can lead to product damage and voids the warranty.

Installing the display on a wall

Typically, you install the display on a wall in a classroom or meeting space.

Choosing a location

A display is typically installed at the room's focal point, such as at the front of a classroom or meeting space.

Selecting an appropriate location is crucial for ensuring the best possible experience with the display. Consider the following factors as you choose a location:

Factor	Considerations
Room setup	<ul style="list-style-type: none"> • The location allows users, including those in wheelchairs, access to the display. Refer to local regulations regarding accessibility. • The location allows for multiple users to access the display at the same time. • The location accommodates room traffic patterns, and there are no tripping hazards. • The display is not installed where it could be hit by a door or gate. • There are no nearby heating or cooling sources directed at the display, such as a radiator, heat vent, or air conditioner. • There are no nearby shelving units, desks, or other furniture that has doors or drawers that could hit the display. • Furniture, wall decor, and other room features, such as light switches and thermostats, do not block the display and are not blocked by it. (You might be able to move some of these room features to accommodate the display.)
Power and other connections	<ul style="list-style-type: none"> • The location is close to: <ul style="list-style-type: none"> ◦ A power outlet ◦ A network outlet (if you plan to use a wired network connection) ◦ A room computer (if you plan to connect a room computer) ◦ External audio systems and other devices that you want to connect to the display <p>Notes</p> <ul style="list-style-type: none"> ◦ If the location is not near a power outlet, consult an electrician for the power setup you need. ◦ Determine if you'll need additional equipment, such as power bars, additional cables, or cable extenders. <ul style="list-style-type: none"> • The location is not where the mains power supply enters the building.

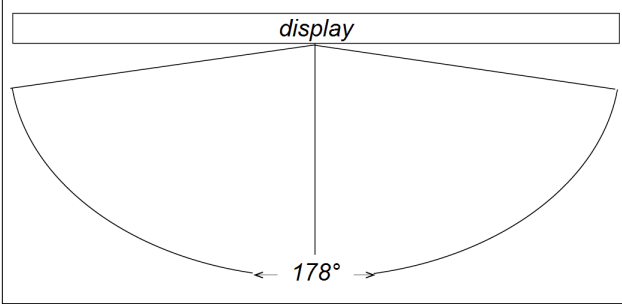
Factor	Considerations
Visibility	<p>The display's screen is clearly visible to all users in the room. SMART recommends users sit within a 178° viewing area:</p>  <p>Note</p> <p>The viewing area depends on the display's resolution and a variety of other factors.</p> <p>See > Recommended viewing distances and viewing angles for SMART Board interactive displays</p>
Lighting	<p>The location is not near bright light sources, such as windows or strong overhead lighting.</p> <p>Risks of light interference include:</p> <ul style="list-style-type: none"> ◦ Reduced visibility: Light sources can cause glare on the display's screen, reducing its visibility. ◦ Touch system interference: Many displays use infrared (IR) light as a key component of the touch system. Strong light that hits the display's screen directly can cause interference with the touch system and prevent the display from working properly. <p>Tip</p> <p>To reduce light interference, install blinds or shades on windows or skylights and install switches to dim or turn off any lights that shinedirectly on the display's screen. Keep in mind that sunlight can come through windows at different angles at different times of the year.</p>
Acoustics	<p>The room has good acoustics.</p> <p>See > The room has good acoustics.</p>

Factor	Considerations
Environment and ventilation	<ul style="list-style-type: none"> • The location meets the environmental requirements in the display's specifications. • The display isn't subjected to strong vibrations or dust. • Ventilation systems don't blow air directly on the display. • There is adequate ventilation or air conditioning around the display so that heat can flow away from it and the mounting equipment. SMART recommends at least 2" (5 cm) of space on all sides of the display for proper airflow. • If you plan to install the display in a recessed area, there is at least 4" (10 cm) of space between the display and the recessed walls to enable ventilation and cooling.

Choosing a height

Consider the general height of the user community when you choose the height for the display.

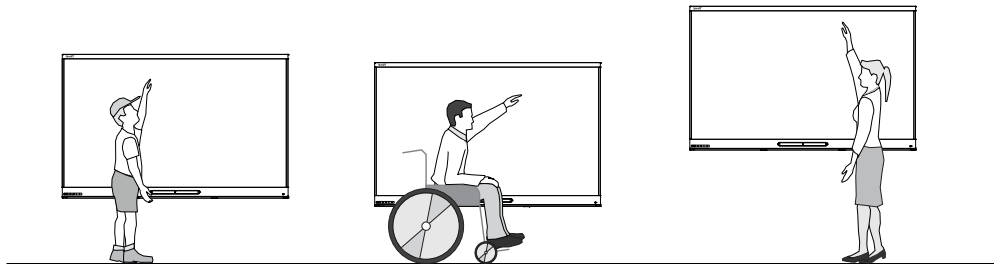

SMART recommends that you mount the display so that its top is 6' 5" (1.9 m) from the floor.

Note

If participants will be sitting at a steep angle (such as in a lecture hall), you may have to adjust the installation height or angle.

See > [Mounting the display](#) on the next page

Assessing the wall

Be sure the wall you're installing the display on can support the weight of the display and mounting equipment. If it can't, consider using a SMART wall stand to transfer some of the weight from the wall to the floor.

See > smarttech.com/accessories

Note

Refer to the display's specifications for its weight.

In some situations, you may need to request an engineering analysis to determine if the wall can support the display.

Selecting mounting hardware

The mounting hardware required for installation varies according to the type of wall onto which the display is being mounted.

If you're using the SMART wall mount (WM-SBID-200), see the wall mount's illustrated installation instructions for information about the required mounting hardware (docs.smarttech.com/kb/171373).

Selecting a wall mount

It is always best to mount the display on a wall. If the wall can't support the display's weight, you can use additional hardware to transfer some of the weight to the floor.

SMART offers the WM-SBID-200 wall mount for mounting the display on a wall. SMART recommends using this wall mount to install the display on a wall.

See the *GX165-V3, GX175-V3, and GX186-V3 installation instructions* (docs.smarttech.com/kb/171905).

Contact your authorized SMART reseller (smarttech.com/where) for information about SMART's mounting options.

If you choose a third-party option rather than one of SMART's mounting options, be sure the wall mount can accommodate the display's dimensions and support the display's weight as well as the weight of any attached accessories.

Mounting the display

The electrical and mechanical components of a display are designed to work properly when the display is mounted in the orientation described in its installation instructions. Mounting the display in a different orientation can cause malfunctions and will void the display's warranty.

Displays are designed for vertical mounting only: 90° relative to the floor, plus or minus 5°–15° for tolerance, depending on the display (consult the display's documentation). SMART doesn't support mounting displays at other angles or in a horizontal orientation (like a tabletop).

There are a number of potential hazards of mounting a display in a non-standard orientation or angle:

- Mounting a display horizontally (like a table) can cause the glass to sag, damaging the display or interfering with the display's touch system.
- Non-standard orientation can affect ventilation, creating hotpots in equipment, premature failures.

Installing the display on a stand

You can install the display on a stand if you want to move the display from place to place or if it's not possible to install the display on a wall.

Notes

- If you want to use the 75" and 86" models (GX175-V3 and GX186-V3) with one of SMART's electric height-adjustable stands, you must first attach a SMART wall mount (model WM-SBID-200, part #1031766, docs.smarttech.com/kb/171405) to the display before mounting the display to the stand. (This applies to the FSE-400, FSE-410, and FSE-420 models of mobile stand and the WSE-400 and WSE-410 models of wall stand).
- For users in Australia and New Zealand: SMART does not provide stands for use in Australia and New Zealand, nor can we provide recommendations for stands from other vendors.

Using SMART mobile stands

SMART mobile stands are designed for SMART Board interactive displays. Some are height-adjustable. Some models include a locking cabinet to secure equipment and casters that swivel and lock for easy movement.

See also > smarttech.com/accessories

Using a third-party stand

For information about selecting and using a third-party stand, see [Installing your SMART Board GX on a stand](#).

Connecting to a network

The display requires a network and internet connection for downloading software and firmware updates.

Configuring network settings

Network administrators need to configure the display's network connection to enable over-the-air firmware updates for a number of the embedded apps.

To configure the network

1. Open the required TCP/UDP ports:

Protocol	Port range	Feature
TCP	80	System software update
TCP	2067	Screen Share app
TCP	5000	AirPlay
TCP	7000	AirPlay
TCP	7236	Miracast
TCP	7382	CRCP
TCP	7385	Screen Share app
TCP	7385–7405	CRCP
TCP	8008	Websocket
TCP	8009	Chromecast
TCP	29736	Screen Share app
TCP	39458	Screen Share app
TCP	49200–49250	Screen Share app
TCP	49200–49420	AirPlay video
UDP	5353	MDNS/Bonjour
UDP	7236	Miracast
UDP	7385–7397	CRCP audio and touchback
UDP	21200	RTP /RTCP
UDP	21201	RTP/RTCP
UDP	49220–49420	AirPlay audio
UDP	49300–49350	Screen Share app
UDP	49400–49450	RTP/RTCP

2. Add the following URLs to the to the network allowlist:

URL	Feature
https://share.bytello.com	Screen Share app
https://ssp.bytello.com/download	Screen Share app

3. Configure the network to enable broadcast service.
4. Configure the network to allow mDNS (multicast).

Connecting to a network

The display requires a network and internet connection for downloading software and firmware updates. You can connect to a network using Wi-Fi or one of the RJ45 Ethernet jacks.

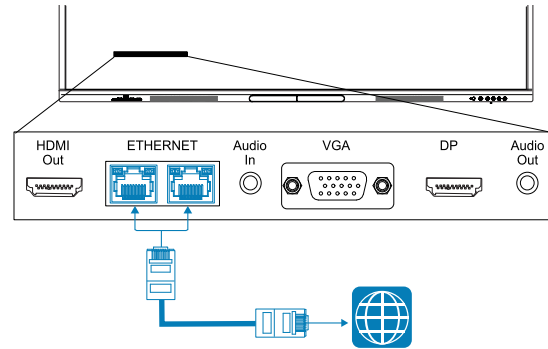

! Important

Do not use the RJ45 jack on an OPS PC to connect to a network.

Note

The display's network connection is shared internally with an OPS PC.

Tip

If you're using one of the display's RJ45 jacks to connect to an Ethernet network, you can connect the other jack to a computer to provide network access for the computer. This is particularly useful if there is only one wired network connection in the room. (Network access is available when the display is on, but not when it's in Standby mode).

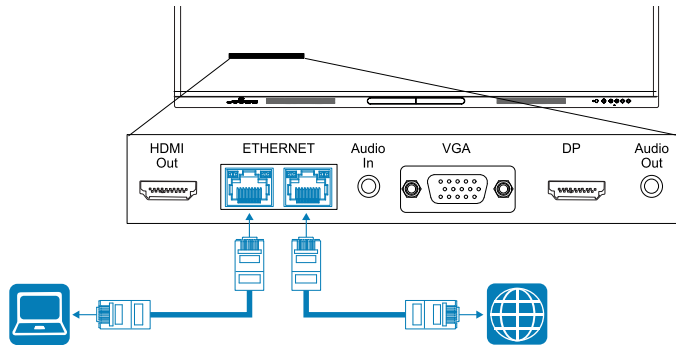

Connecting power and turning on the display for the first time

To connect the display to power

Connect the supplied power cable from the AC power inlet on the back of the display to a power outlet.

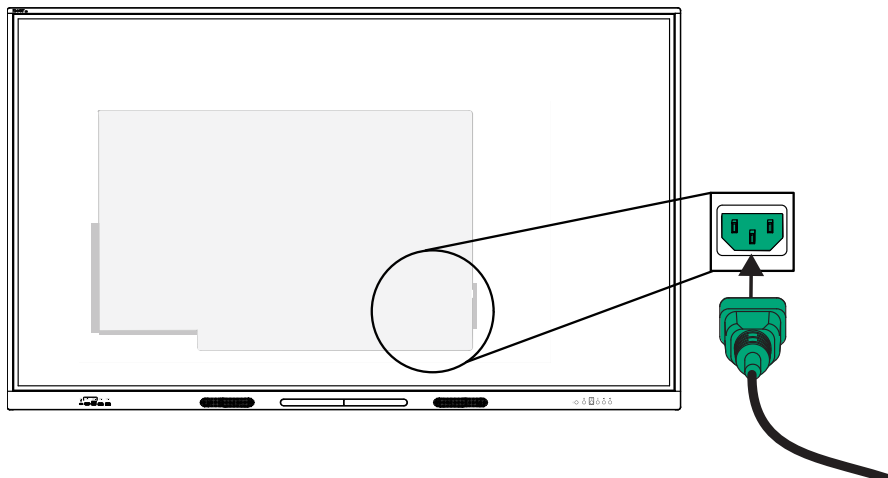

Note

Refer to the display's specifications for power requirements and power consumption information (see *More information* on page 15).

To turn on and set up the display for the first time

⚠ Caution

- Install the OPS appliance before you turn on the display. If you can't reach the power switch, use the front control panel's power button  to put the display in Standby mode, and then unplug the display's power cable from the power outlet.
- Make sure the OPS appliance is secured to the display with screws through the two anchor points. Inadequately secured appliances can damage the display. (An OPS appliance's anchoring screws are typically captive, although some simply include separate anchoring screws. Third-party OPS appliances are not supported, and their use can lead to poor performance or damage to the display.)

! **Important**

- The display's first-time setup procedure will not complete successfully if you try to connect to a Wi-Fi network that requires a user name. If you would like to connect the display to a Wi-Fi network that requires a user name, you can do that after you complete the first-time setup.

See > *To connect to a Wi-Fi network* on the next page

1. Flick the power switch beside the AC power inlet on the rear of the display to the ON (I) position.

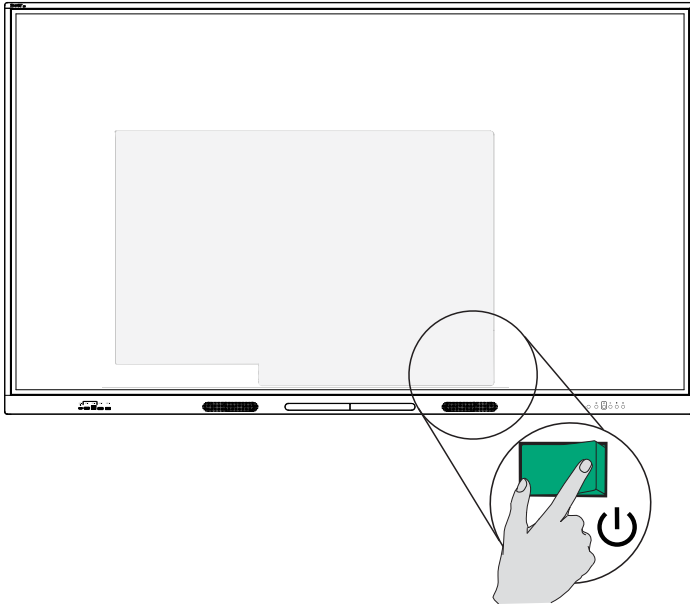

2. Select your preferred language, and then tap the **Next** icon ➔.
3. Select the country location where you're installing the display. This helps to ensure the proper Wi-Fi frequencies for wireless networks are available. Tap the **Next** icon ➔.
4. Select an Ethernet connection or wireless network. To add a hidden Wi-Fi network manually, tap the **Add Network** icon +.

! **Important**

The display needs an internet connection for downloading and installing important updates. Ask the network administrator to verify that the display can access the network by making sure the display's built-in browser can access the internet.

5. Tap the **Next** icon ➔.

6. Set the date, time and timezone, and then tap the **Next** icon .

You can also enable the display's date and time to be set automatically.

See > *System* on page 70

7. Set a password for the screen lock feature, and then tap **Enter**.

 **Important**

Ensure the screen lock passcode is made available to authorized users of the display. Users must enter the passcode to unlock the display's screen when the Screen lock feature is enabled.

The Done screen indicates setup is finished.

Configuring the display's network settings

Use the procedures in this chapter to update network settings after turning on the display. The chapter describes:

- Connecting to a Wi-Fi network
- Configuring network proxy settings for a Wi-Fi network
- Installing a digital network certificate for a Wi-Fi network
- Connecting to an Ethernet network
- Configuring a wireless hotspot
- Connecting the display to a wireless hotspot
- Adding a VPN connection



Note

When the display is connected to a network using Wi-Fi its Ethernet connection will be turned off (and vice versa).

To connect to a Wi-Fi network

1. On the Home screen, tap the **Wi-Fi** icon  in the top-right corner.

OR

On the Home screen, tap the **Apps** icon  and then tap the **Settings** icon  > **Network** > **Wi-Fi**.

2. Turn the **Wi-Fi** switch on.



3. Select a wireless network.

If the Wi-Fi network is not password protected, the display connects to the network.

OR



If the network requires a password, enter the Wi-Fi password and tap **Connect**. Options are also available for adding a certificate and accessing the advanced setting to configure Proxy and IP Settings.

Notes

- Tap the Add Network icon  to add a network manually.
- Tap the More menu items icon  to access *Wi-Fi preferences* and see your MAC address, IP address, and install certificates.



To configure network proxy settings for a secured Wi-Fi network

To improve security and privacy, or to meet company policy, you can configure a secured network proxy for your Wi-Fi network.

1. On the Home screen, tap the **Apps** icon  and then tap the **Settings** icon  > **Network** > **Wi-Fi**.
2. Toggle the **Wi-Fi** switch to on and tap a secured network.
3. Choose a Security option.
4. Type your network credentials (including a network password).
5. Ensure **Advanced settings** is selected.
6. Select options as required from the **Proxy** and **IP Settings** drop-down lists.
7. Tap **Connect** to save the settings.

To install a digital network certificate for a Wi-Fi network

To improve security and provide assurance of network authentication, you can install an SSL (secure sockets layer) certificate in the display.

1. On the Home screen, tap the **Apps** icon  and then tap the **Settings** icon  > **Network** > **Wi-Fi**.
2. Plug the USB drive that contains the SSL certificate into a USB port on the display.
3. Tap the More menu items icon  > **Wi-Fi preferences** > **Install certificates**.
4. Browse to the certificate on the USB drive.
5. Select the certificate. The **Name the certificate** dialog opens.

6. Change the name of the certificate (optional), and remember the name.
7. Under **Credential use**, select **Wi-Fi**.

When you join Wi-Fi networks that require a certificate, you will have the option to select the installed certificate.

To connect to an Ethernet network

1. Connect an Ethernet cable to either of the RJ45 jacks on the display.
2. On the Home screen, tap the **Ethernet** icon  in the top-right corner.

OR

On the Home screen, tap the **Apps** icon  and then tap the **Settings** icon  > **Network** > **Ethernet**.

3. Toggle the **Ethernet switch** to on.
4. To obtain an IP address automatically, turn the **Obtain IP address automatically (DHCP)** switch on.



OR

Tap **IP Address** and fill out the static network configuration options as necessary.

To configure a wireless hotspot

Notes



- The wireless hotspot feature is available when the display is connected to the network with an Ethernet connection.
- When the wireless hotspot is enabled, the display's Wi-Fi connection is disabled.

1. On the Home screen, tap the **Apps** icon  and then tap the **Settings** icon  > **Network** > **Hotspot**.
2. Toggle the **Hotspot** switch to on.
3. You can use the default Hotspot name and password or tap the fields and enter your own.
4. Optionally, tap the **Security** drop-down list and select a method of encryption.
5. If you selected Encryption, type a password in the *Password* text box. This password is required when users connect their devices to the wireless hotspot.
6. Select a bandwidth frequency (2.4 GHz or 5 GHz).
7. Tap **Save**.

To connect to the display's wireless hotspot

1. On a computer or mobile device, view the list of available Wi-Fi networks and select the display's wireless hotspot.
2. Type the password for the display's wireless hotspot.
3. Connect to the display's wireless hotspot.

To add a VPN connection

1. On the Home screen, tap the **Apps** icon  and then tap the **Settings** icon  > **Network** > **VPN**.
2. Tap **Add VPN**.
3. Complete the following steps:
 - Type the name of the VPN in the *Name* text box.
 - Select a type of VPN from the *Type* drop-down menu.
 - Type the server address in the *Server address* text box.
 - You can select the *PPP encryption(MPPE)* checkbox to enable Microsoft Point-to-Point Encryption (MPPE).
 - Type a user name and password.
4. Click **Save**.

Chapter 3 Connecting computers and other devices

- Installing SMART software 32
- Connecting room computers and guest laptops 33
 - Viewing a connected computer or other device’s input 40
 - Setting a connected computer’s resolution and refresh rate 41
 - Using recommended cables 42
 - Sharing USB Type-B receptacles 43
- Connecting a SMART OPS PC module 43
- Connecting other devices 44
 - Connecting USB drives and other peripherals 44
 - Connecting an external display 45
 - Connecting an external audio system 46
 - Connecting room control systems 48
- Connector diagrams 49
 - Side and bottom connector panels 49
 - Front connector panel 52

Warning
Ensure that any cables that cross the floor to the display are properly bundled and marked to avoid a trip hazard.

Installing SMART software

The display comes with SMART software that you can install on connected room computers and guest laptops. Other SMART software is optional.

Included



Optional



Lumio by SMART



SMART Notebook Plus

**SMART
Remote
Management**

SMART Remote Management



SMART Meeting Pro



SMART TeamWorks Room

See > smarttech.com/downloads

Connecting room computers and guest laptops

If you install cables for room computers and guest laptops in advance, you can make use of connectors that might not be accessible after the display is mounted on the wall. You can then run the cables across floors or behind walls as needed.

Notes

- Install SMART software on computers you connect to the display (see *Installing SMART software* on the previous page).
- Make sure [SMART Product Drivers 12.20](#) or later are installed on any connected computers.
- As shown below, HDMI 1, HDMI 2, VGA, and Display Port share the Touch USB Type-B receptacle on the side connector panel, and HDMI 3 uses the Touch USB Type-B receptacle on the front connector panel (see *Sharing USB Type-B receptacles* on page 43).
- The USB Type-C connector on the front connector panel provides up to 15 W of power for charging connected devices.

The following are the locations of the connectors and the connector and cable information for the display's inputs.

- **USB Type-C 1**

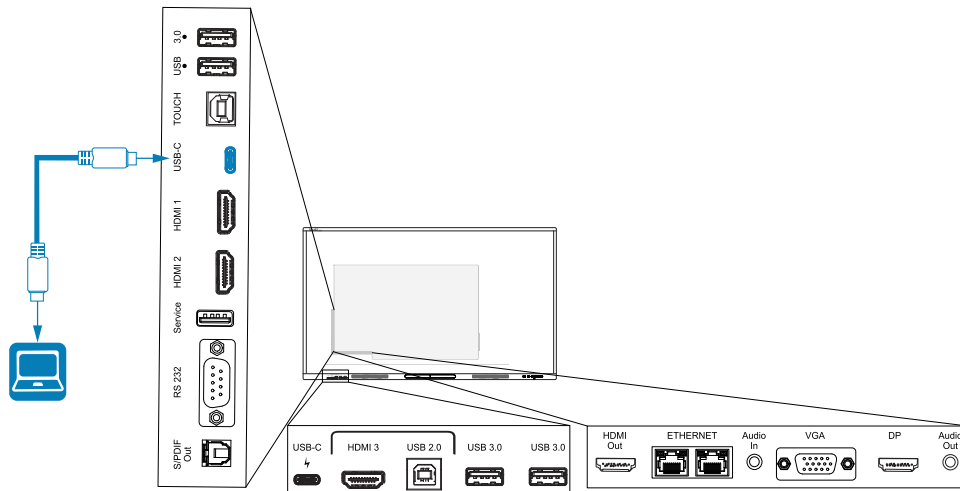

Connector	Standard	Connection type	Cable
USB Type-C 1	USB-C	Video/audio/touch	<u>SuperSpeed USB Type-C</u>

- **USB Type-C 2**

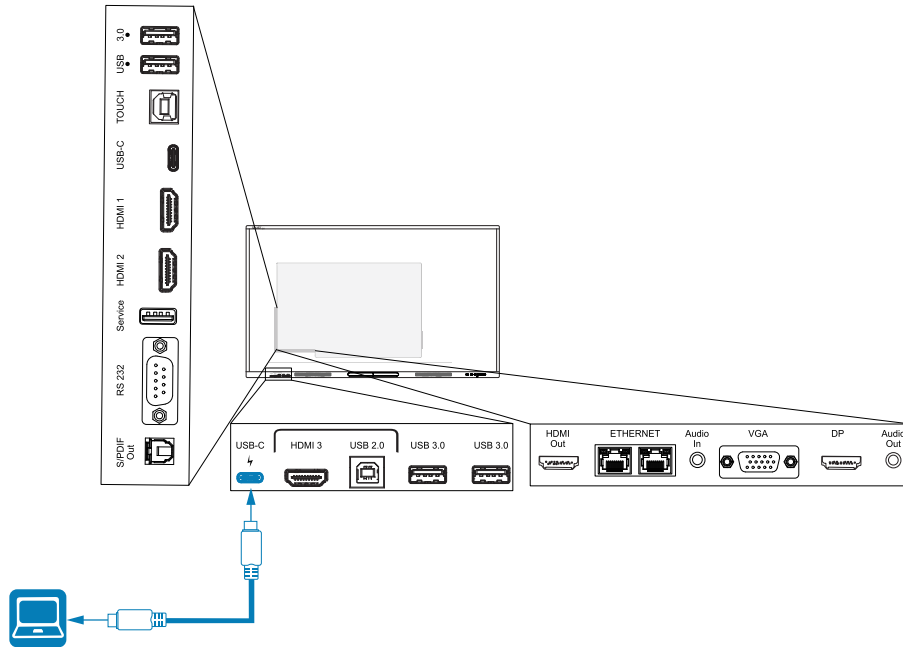

Connector	Standard	Connection type	Cable
USB Type-C 2	USB-C	Video/audio/touch	<u>SuperSpeed USB Type-C</u>

- **HDMI 1**

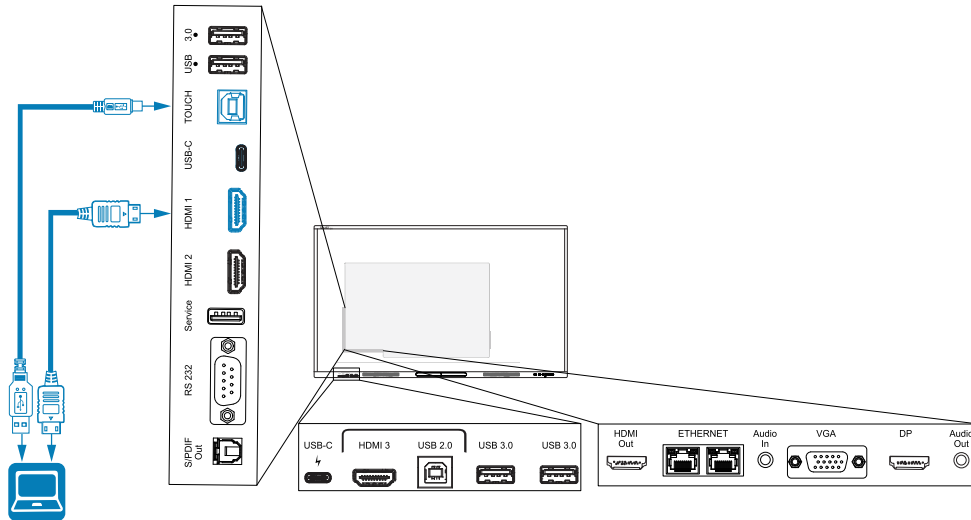

Connector	Standard	Connection type	Cable
HDMI 1	HDMI 2.0	Video/audio	<u>Premium High Speed HDMI (18 Gbps)</u>
Touch	USB 2.0 Type-B	Touch	<u>High Speed (480 Mbps) USB 2.0</u>

- **HDMI 2**

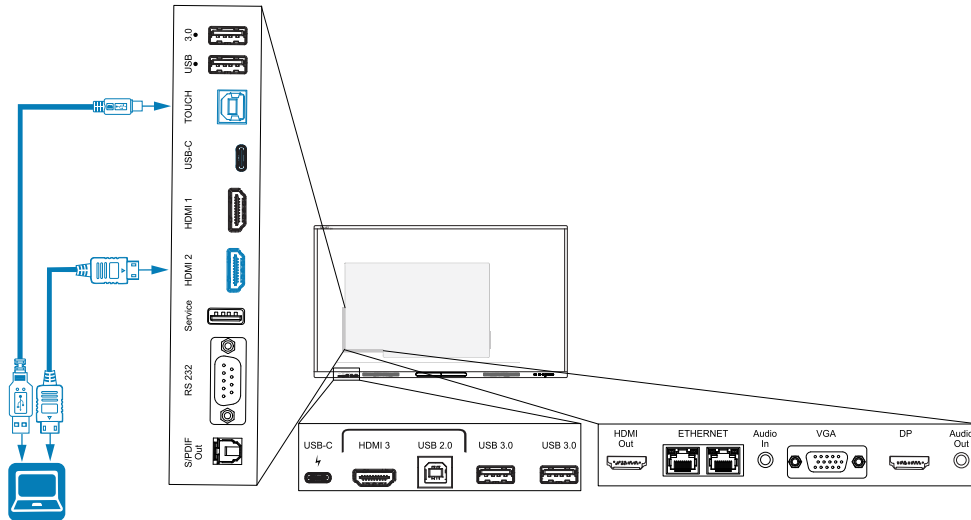

Connector	Standard	Connection type	Cable
HDMI 2	HDMI 2.0	Video/audio	<u>Premium High Speed HDMI (18 Gbps)</u>
Touch	USB 2.0 Type-B	Touch	<u>High Speed (480 Mbps) USB 2.0</u>

- HDMI 3

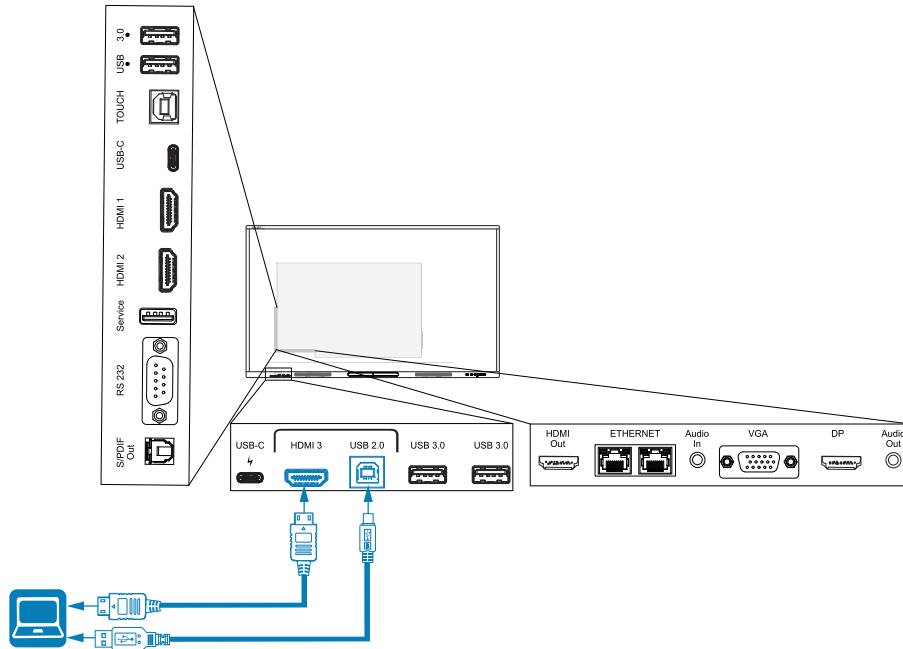

Connector	Standard	Connection type	Cable
HDMI 3	HDMI 2.0	Video/audio	<u>Premium High Speed HDMI (18 Gbps)</u>
Touch input	USB 2.0 Type-B	Touch	<u>High Speed (480 Mbps) USB 2.0</u>

- Display Port

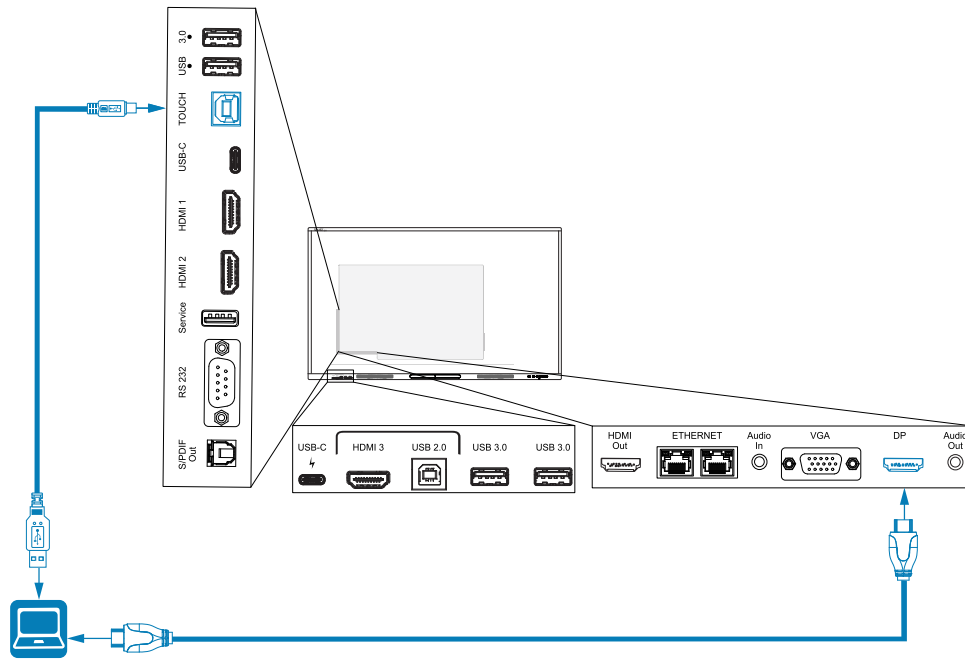

Connector	Standard	Connection type	Cable
Display Port	Display Port 1.2	Video/audio	<u>Display Port</u>
Touch	USB 2.0 Type-B	Touch	<u>High Speed (480 Mbps) USB 2.0</u>

• **VGA**

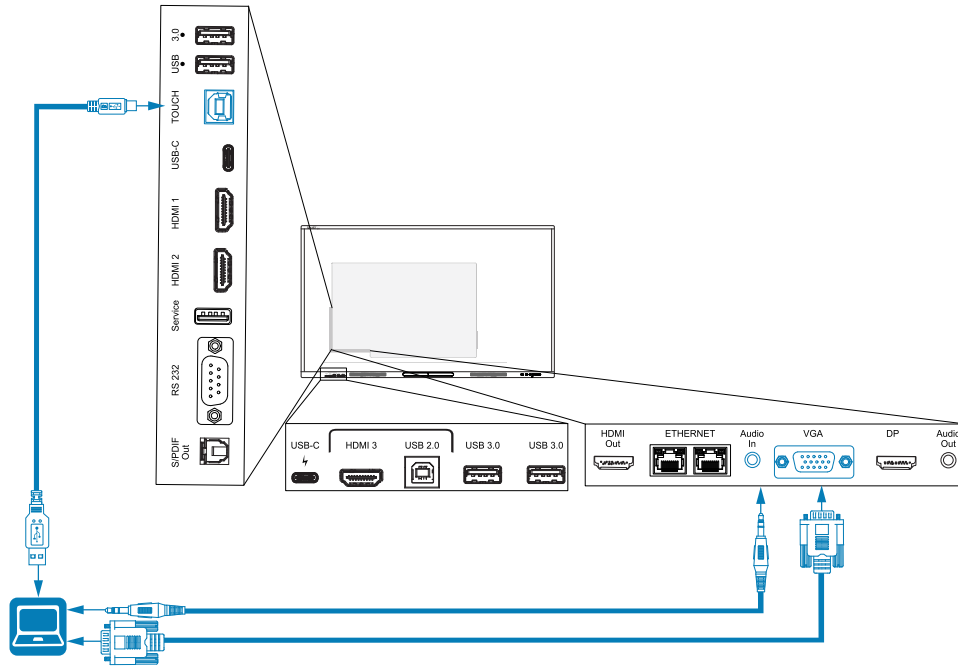

Connector	Standard	Connection type	Cable
VGA	VGA	Video	<u>VGA</u>
Audio In	Stereo 3.5 mm	Audio	<u>Stereo 3.5 mm</u>
Touch	USB 2.0 Type-B	Touch	<u>High Speed (480 Mbps) USB 2.0</u>





Viewing a connected computer or other device's input

1. Connect a device to the display's HDMI 1, HDMI 2, HDMI 3, USB Type-C 1, USB Type-C 2, Display Port, or VGA connectors.

Note

To enable touch control of the device, connect a USB cable to the associated USB connector. Devices connected to the USB Type-C connector don't require an additional USB connection to enable touch.

2. Select the source using one of the following methods:

Using the Input settings menu	Using the remote control
<ol style="list-style-type: none"> a. Open the Toolbar by tapping one of the side Toolbar buttons  (on either sides of the screen). b. Tap the Input icon . <p>Tip</p> <p>Tap the More icon  to find the Input icon if it doesn't appear in the Favorite widgets list in the Toolbar.</p>	<p>Press the Input icon .</p>

Note

A green circle  appears around the currently selected input (PC, Android, HDMI1, HDMI2, HDMI3, Type-C1, Type-C2, DP, or VGA). Inputs with a connected source have a green dot beside the input name, rather than a gray dot. The input name also appears in green text rather than gray when an input is connected.

3. Tap the computer's input or use the navigation keys on the remote control to select the source and then press the **OK** button.

The device's output appears on the display's screen.

Tip

You can rename inputs, enable or disable inputs, configure the display to turn on when an active video signal is connected, and automatically switch the input when an active video signal is connected.

See > *Input and output* on page 67.

Setting a connected computer's resolution and refresh rate

This table presents the recommend resolutions and refresh rates for the display's inputs:

If possible, set connected computers to these resolutions and refresh rates. See the computers' operating system documentation for instructions.

Using recommended cables

SMART recommends the following varieties of cable:

Cable type	Maximum length	Recommendation
Display Port	23' (7 m) ¹	Use only certified Display Port 1.4 cables that have been tested to support the performance standard you require.
HDMI	23' (7 m)	Use only certified Premium High-Speed HDMI (18 Gpbs) cables that have been tested to support the performance standard you require.
VGA	23' (7 m)	Use VGA cables with all pins in their connectors fully populated and wired.
Stereo 3.5 mm	20' (6 m)	Use only shielded 3.5 mm cables <div style="border-left: 2px solid #0070C0; padding-left: 10px; margin-left: 10px;"> <p>ⓘ Important</p> <p>Use only a 3.5 mm stereo jack (15 mm long barrel) to connect to the display.</p> </div>
USB 2.0	16' (5 m)	See > <i>USB extenders</i> on page 14
USB 3.0	9' (3 m)	SMART supports only installations that use directly connected video and USB cables, or AC-powered extenders. You might be able to use higher-grade cables that exceed the recommended length. If you have problems with such a cable or an extender of any type, test the connection with a shorter cable before contacting SMART Support.
USB Type-C	6' 6" (2 m) for SuperSpeed 5Gbps cables	USB-IF certified USB 3.2 Gen 1 Type-C cable, SuperSpeed (5 Gbps) support To use a USB Type-C cable for video, you need: <ul style="list-style-type: none"> • A full-featured cable that supports SuperSpeed 5Gbps (or faster) data rates. • A computer that supports Display Port Alternate Mode via USB Type-C <div style="border-left: 2px solid #0070C0; padding-left: 10px; margin-left: 10px;"> <p>Note</p> </div>

Using cables that exceed these maximum lengths may produce unexpected results, intermittent loss of picture, or degraded picture quality and USB connectivity.

¹The performance of cables longer than 23' (7 m) is highly dependent on the cable's quality.

Sharing USB Type-B receptacles

The HDMI, VGA, and Display Port connectors on the rear connector panels (back of the display) all share a single USB Type-B receptacle on the rear, side panel. This means the touch system can be used with only one device connected to these video inputs.

The touch system can still be used with a device connected to USB Type-B receptacle even when one of the video connectors is connected to another display.

USB Type-B receptacle	Video connectors
Touch	<ul style="list-style-type: none"> • HDMI 1 • HDMI 2 • VGA • Display Port

Connecting a SMART OPS PC module

If your organization has purchased a SMART OPS PC module, you or your organization's installers can install the module in the display's accessory slot following the OPS PC module's installation instructions (docs.smarttech.com/kb/171775 or docs.smarttech.com/kb/171544). You can then view the OPS PC module's input on the display.

See > *SMART OPS PC modules user guide* (docs.smarttech.com/kb/171747)

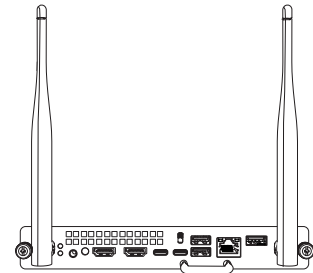

Caution

- Only SMART-provided OPS appliances are supported in SMART Board interactive displays. Third-party OPS appliances are not supported, and their use can lead to poor performance or damage to the display.
- Do not install or remove the OPS appliance while the display is turned on. First make sure the power switch on the back of the display beside the AC power inlet is in the OFF (O) position. If you can't reach the power switch, use the front control panel's power button  to put the display in Standby mode, and then unplug the display's power cable from the power outlet.
- After you have turned the display's power switch off or unplugged it, wait at least 30 seconds before removing the appliance to allow its internal power supplies to discharge completely. You might also wait five minutes to give the appliance the opportunity to cool, if necessary.

Make sure the OPS appliance is secured to the display with screws through the two anchor points. Inadequately secured appliances can damage the display. (An OPS appliance's anchoring screws are typically captive, although some simply include separate anchoring screws.)

-

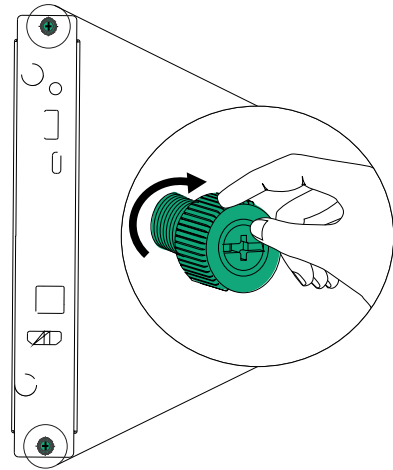

Connecting other devices

In addition to computers, you can connect a variety of other devices to the display:

- USB drives and other peripherals
- External displays
- External audio systems
- Room control systems

Connecting USB drives and other peripherals

The display includes two USB 3.2 Gen 1 Type-A receptacles on the front connector panel and two USB 3.2 Gen 1 Type-A receptacles on the side connector panel. You can connect USB drives, peripherals (such as keyboards), and other devices to the USB 3.2 Gen 1 Type-A receptacles and use these devices with the display's embedded OS or OPS slot computer. The display's USB 3.2 Gen 1 Type-A receptacles will switch to the active input.

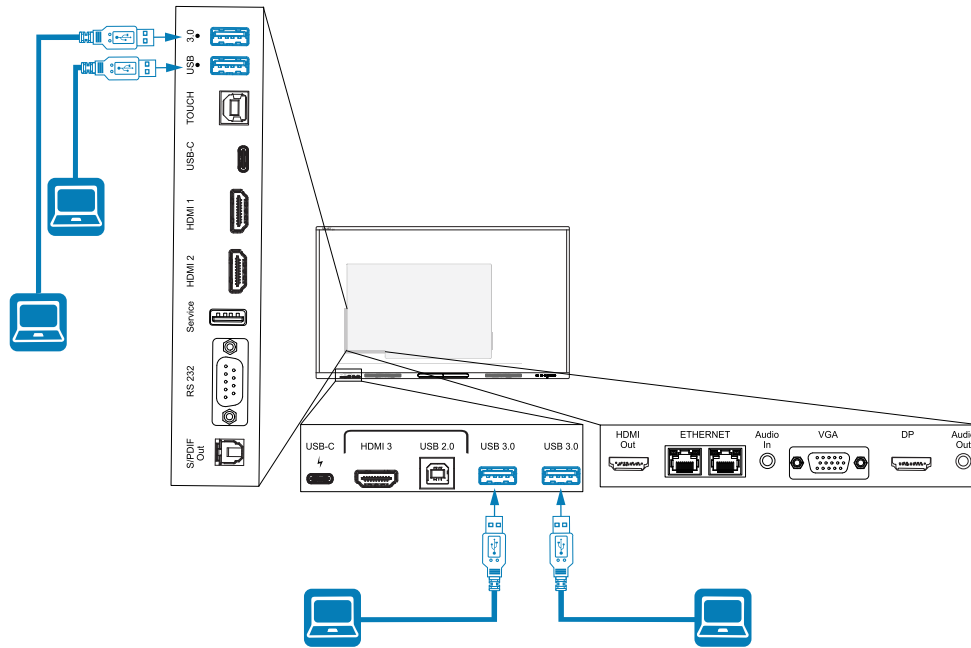

Connecting an external display

You can connect an external display using the HDMI 2.0 out connector on the connector panel.

The external display shows the same image as the display. This is useful when you're using the display in an auditorium or other large space where a second display would be beneficial.

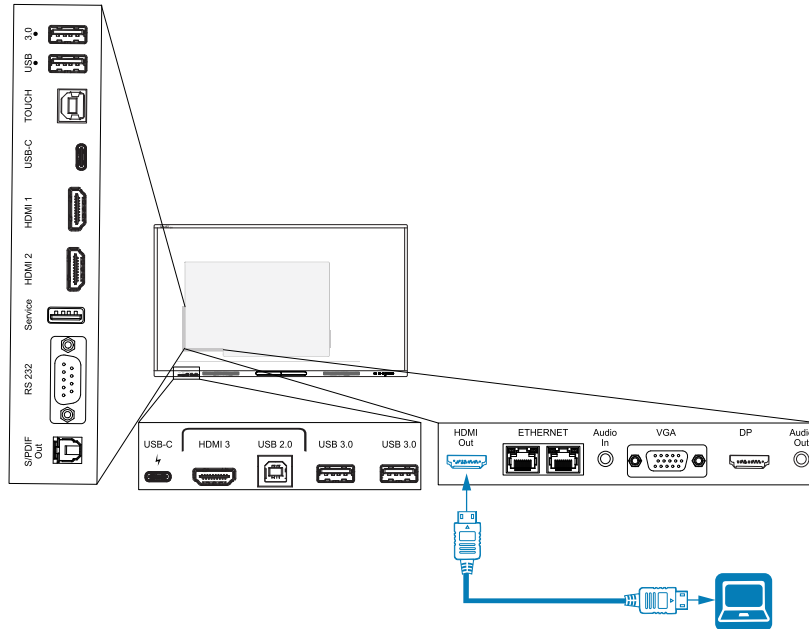

! **Important**

If the connected external display doesn't support High-bandwidth Digital Content Protection (HDCP), no image will appear on the external display. For full resolution output, connect a display that supports HDCP.

Note

The display's default output resolution is 4K (3840 × 2160). The output resolution can also be set to 1080p 60Hz in display settings.

See > *Input and output* on page 67.

Connecting an external audio system

The display includes two 20 W speakers, which are designed to provide sound at the front of a room. You might want to connect a third-party external audio system if you're providing sound in a larger space.

You can connect an external audio system to the display using the stereo 3.5 mm out connector (pictured). You can also connect an external audio system directly to a room computer.

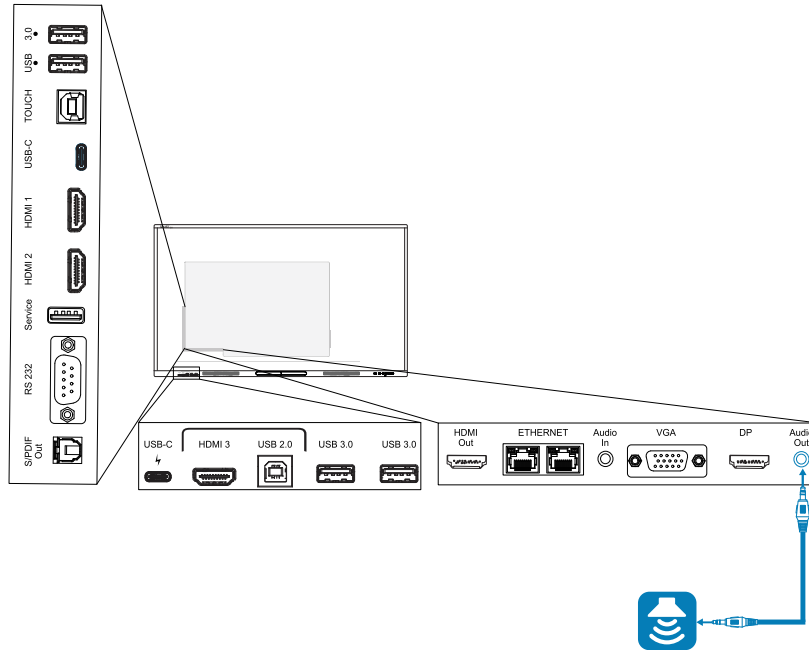

Use of an external audio system must be enabled in display settings (see *Input and output* on page 67).

! **Important**

Use a 3.5 mm stereo jack (15 mm long barrel only) to connect to the display's stereo 3.5 mm Out connector.

Note

- You can use the display's volume controls to adjust the volume of an audio system connected to the display's stereo 3.5 mm Out connector.

In addition to the stereo 3.5 mm out connector, the display also provides a Sony/Philips Digital Interface (S/PDIF) Out connector (pictured). S/PDIF is a digital audio transmission medium. You need an audio receiver that supports S/PDIF to use this connection with an external sound bar or other audio system.

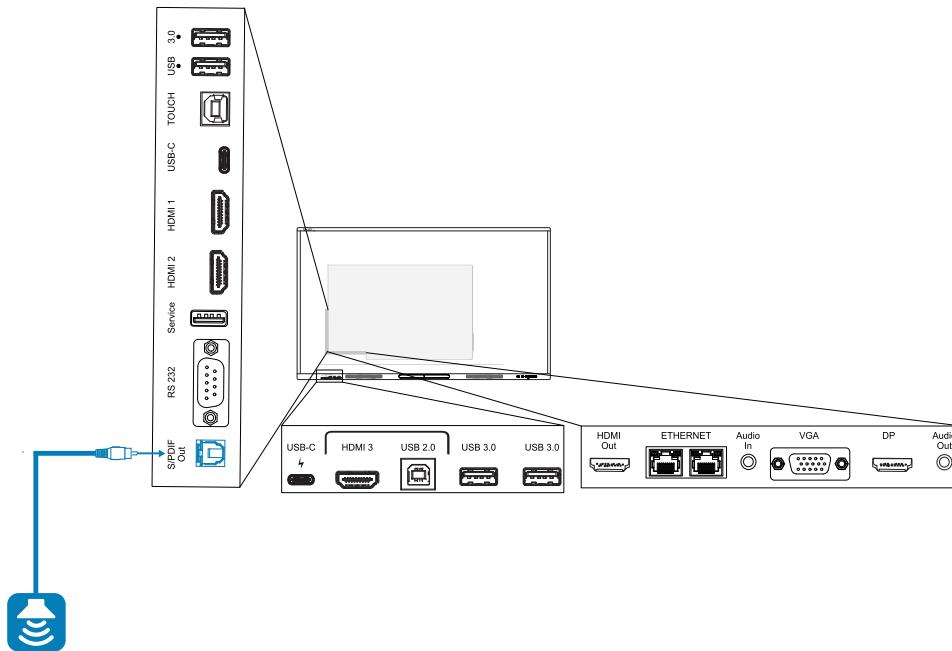

Note

When you connect an audio system to the display's S/PDIF Out connector, the audio system's volume controls, rather than the display's, adjust the volume.

Connecting room control systems

A room control system enables users to control a room's lighting, audio system, and possibly, the display. Some installations may require you to integrate the display with a room control system.

You can use the display's RS-232 connector to connect a third-party external control system to the display (see *Appendix C Managing the display using RS-232* on page 82).

Note

displays are not compatible with centralized remote control systems, such as a universal remote control.

Connector diagrams

Side and bottom connector panels

This diagram and table describe the connectors on the display's connector panel:

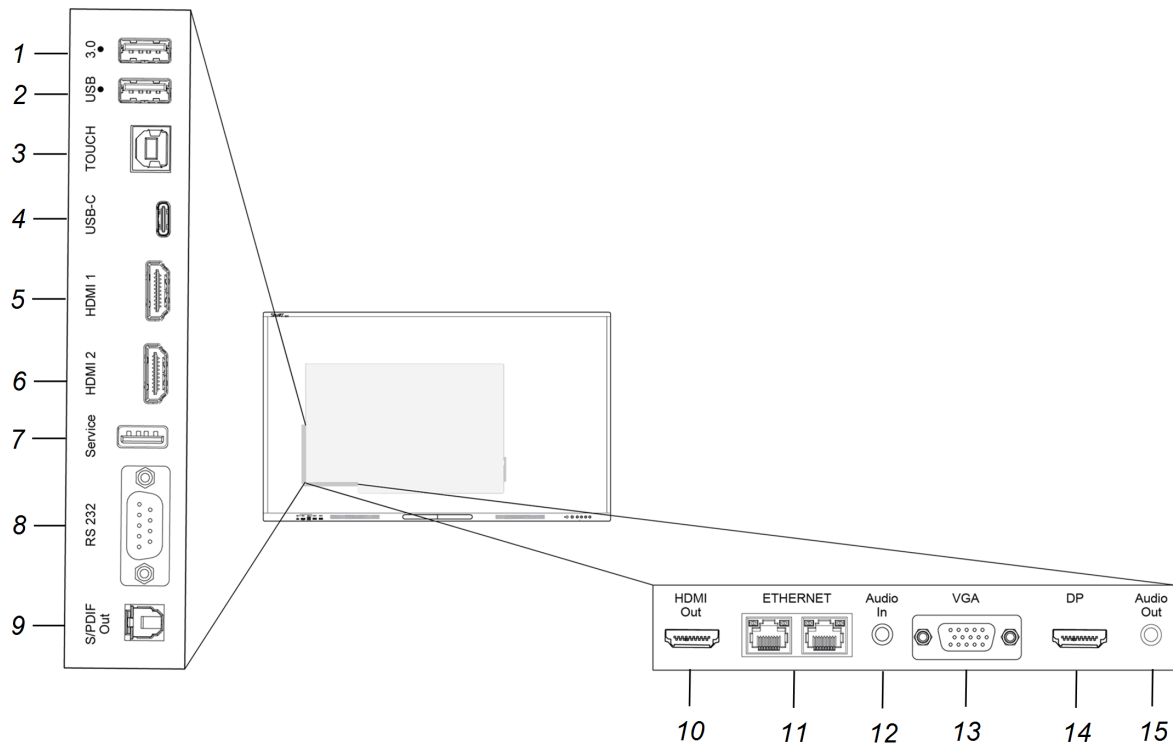

No.	Connector	Connects to	Notes
1	USB 3.2 Gen 1 Type-A	Supported USB drives and other peripherals	<p>See > <i>Connecting other devices</i> on page 44</p> <p>See > USB cables and connectors</p> <p>The connector will switch to the active input, including the display's embedded OS, the OPS slot computer, or an external computer.</p> <p>Note</p> <p>Connect a USB mouse to navigate the display's on-screen menu during troubleshooting.</p>

No.	Connector	Connects to	Notes
2	USB 3.2 Gen 1 Type-A	Supported USB drives and other peripherals	<p>See > <i>Connecting other devices</i> on page 44</p> <p>See > USB cables and connectors</p> <p>The connector will switch to the active input, including the display's embedded OS, the OPS slot computer, or an external computer.</p> <p>Note</p> <p>Connect a USB mouse to navigate the display's on-screen menu during troubleshooting.</p>
3	USB 2.0 Type-B	Touch	<p>See > <i>Connecting other devices</i> on page 44</p> <p>See > USB cables and connectors</p>
4	USB 2.0 Type-C	USB Type-C 1 input (supported USB drives, video, audio, and touch)	<p>See > <i>Connecting other devices</i> on page 44</p> <p>See > USB cables and connectors</p> <p>The connector will switch to the active input, including the display's embedded OS, the OPS slot computer, or an external computer.</p>
5	HDMI 2.0	HDMI 1 input (video and audio)	See > <i>Connecting room computers and guest laptops</i> on page 33
6	HDMI 2.0	HDMI 2 input (video and audio)	See > <i>Connecting room computers and guest laptops</i> on page 33
7	USB 2.0 Type-A	N/A	This connector is a service port (connects to the embedded OS).
8	RS-232	Room control system	<p>See > <i>Appendix C Managing the display using RS-232</i> on page 82</p> <p>See > RS-232 cables and connectors</p>
9	S/PDIF Out	Digital audio output	<p>See > <i>Connecting an external audio system</i> on page 46</p> <p>See > Digital audio cables and connectors</p>

No.	Connector	Connects to	Notes
10	HDMI 2.0 out	External display	See > <i>Connecting an external display</i> on page 45
11	RJ45 (x2)	Network	See > <i>Connecting to a network</i> on page 23 See > <u>Ethernet (network) cables and connectors</u>
12	Audio in (stereo 3.5 mm)	VGA input (audio)	Use this audio input with Stereo 3.5 mm in. See > <i>Connecting room computers and guest laptops</i> on page 33 See > <u>Analog audio cables and connectors</u>
13	VGA in	VGA input (analog video)	Use this video input with analog video sources (VGA). See > <i>Connecting room computers and guest laptops</i> on page 33 See > <u>Analog audio cables and connectors</u> Use this video input with Touch (USB) connector for touch control.
14	Display Port 1.2	Display Port 1.2 input (video and audio)	See > <i>Connecting room computers and guest laptops</i> on page 33 See > <u>Display Port cables and connectors</u>
15	Audio out	External audio system	See > <i>Connecting an external audio system</i> on page 46 See > <u>Analog audio cables and connectors</u>

Front connector panel

This diagram and table describe the connectors on the display's front connector panel:

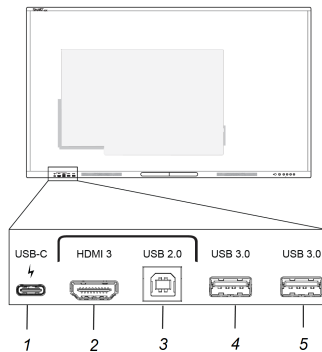

No.	Connector	Connects to	Notes
1	USB 2.0 for the embedded OS and OPS slot computer USB 3.2 Gen 1 for peripherals	USB Type-C 2 input (video, audio, and touch)	<p>See > Connecting other devices on page 44</p> <p>See > USB cables and connectors</p> <p>The connector will switch to the active input, including the display's embedded OS, the OPS slot computer, or an external computer.</p> <p>Note</p> <p>The USB 3.2 Type-C connector can also provide 15 W of power to connected devices.</p>
2	HDMI 2.0 in	HDMI 3 input (video and audio)	<p>See > Connecting room computers and guest laptops on page 33</p> <p>See > HDMI cables and connectors.</p>
3	USB 2.0 Type-B	Touch input	<p>Use this touch input with the HDMI video and audio input on the front of the display.</p> <p>See > Connecting room computers and guest laptops on page 33</p> <p>See > USB cables and connectors.</p>

No.	Connector	Connects to	Notes
4	USB 3.2 Gen 1 Type-A	Supported USB drives and other peripherals	<p>See > <i>Connecting other devices</i> on page 44</p> <p>See > <u>USB cables and connectors</u></p> <p>The connector will switch to the active input, including the display's embedded OS, the OPS slot computer, or an external computer.</p>
5	USB 3.2 Gen 1 Type-A	Supported USB drives and other peripherals	<p>See > <i>Connecting other devices</i> on page 44</p> <p>See > <u>USB cables and connectors</u></p> <p>The connector will switch to the active input, including the display's embedded OS, the OPS slot computer, or an external computer.</p>

Chapter 4 Maintaining the display

Turning the display on or off	54
Cleaning and maintaining the display	55
Checking the display installation	55
Cleaning the screen	56
Cleaning the touch sensors	56
Maintaining ventilation	57
Preventing condensation	57
Replacing the pens	57
Removing and transporting the display	58
Updating system firmware	59
Applying a firmware update	59

With proper maintenance, the display will provide years of use.

Turning the display on or off

In most situations, you can put the display in Standby mode when not using it by following the instructions in *SMART Board GX (V3) series interactive displays user guide* (docs.smarttech.com/kb/171903).

In some situations, such as when you move the display or clean its screen, you need to turn the display off. You can turn it back on after.

To turn the display off

1. Press and hold the Power button  on the front control panel or remote control for three seconds to begin a 10 second countdown before the display enters Standby mode and the status light stops blinking.

2. Flick the power switch (beside the AC power inlet) on the bottom of the display's rear surface to the OFF (O) position.

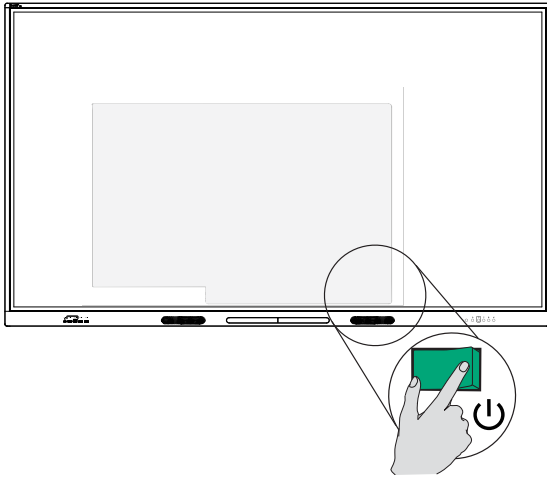

To turn the display on

Flick the power switch (beside the AC power inlet) on the bottom of the display's rear surface to the ON (I) position.

To turn the display on or off (with an OPS module installed)

- If *PC* is currently set as the default input in display settings (see *Startup and shutdown in System* on page 70), the OPS module will start automatically when the display is turned on.
- Before turning off the display, turn off the OPS module using the power controls on the OPS module (such as the *Shut down* command in the Windows 10 start menu on the OPS).
- When the OPS module is turned off, it is then safe to turn off the display using the steps listed above in *To turn the display off*.

Cleaning and maintaining the display

Checking the display installation

Inspect the display installation frequently to ensure that the display remains securely installed.

- Check the mounting location for signs of damage or weakness that can occur over time.
- Check for loose screws, gaps, distortions, or other issues that could occur with the mounting hardware.

If you find an issue, contact a trained installer.

Cleaning the screen

Follow these instructions to clean the screen without damaging its anti-glare coating or other product components.

Caution

- Do not use permanent or dry-erase markers on the screen. If dry-erase markers are used on the screen, remove the ink as soon as possible with a lint-free, non-abrasive cloth.
- Do not rub the screen with dense or rough material.
- Do not apply pressure to the screen.
- Do not use strong cleaning solutions or glass cleaners on the screen. They can damage or discolor the screen.

To clean the screen

1. Turn off any connected computers.
2. Turn off the display.
3. Wipe the screen with a lint-free, non-abrasive cloth.

Note

You can also use a damp cloth with a drop of dish soap, or follow the instructions in the knowledge base article, [How to clean SMART Board surfaces and accessories](#).

Cleaning the touch sensors

The display uses infrared (IR) transmitters and sensors around the display's perimeter between the screen and the frame. Dust buildup on the protective plastic can impair touch performance. Inspect these areas for dust, and clean them every week.

Caution

- Do not use compressed air to clean the sensors or borders.
- Do not use water or cleaning agents to clean the touch sensors.
- Do not apply too much pressure when cleaning the display because you can damage the plastic.

To clean the IR transmitters and sensors

1. With a clean lint-free, non-abrasive cloth, gently wipe the plastic between the screen and the frame around the perimeter of the display's screen.
2. If dirt still remains, use 50% isopropyl alcohol to clean the protective plastic between the screen and the frame.

Maintaining ventilation

The display requires proper ventilation. Dust buildup in the ventilation holes compromises cooling and can lead to product failure.

- Clean accessible ventilation holes monthly with a dry cloth.
- Use a vacuum cleaner with a narrow hose end fitting to clear the back ventilation holes regularly. You might have to remove the display from the wall.

For more information about removing the display, see *Removing and transporting the display* on the next page.

Caution

Avoid setting up or using the display in an area with excessive levels of dust, humidity, smoke, or chemical fumes.

Preventing condensation

If the display has been moved from a cold environment to a warmer one (for example, from storage to the installation site), let the display sit for a few hours to allow it to acclimate to the new temperature. Failing to do so can cause humidity to build up in the space between the front glass and the LCD.

If condensation appears under the screen after you turn on the display, select an active video source and leave the display on for 48 hours. If the condensation doesn't dissipate, contact SMART support if the display is still under warranty.

If there is enough moisture between the layers to cause the moisture to drip and run, remove power immediately and contact SMART Support if the display is still under warranty.

Replacing the pens

To prevent damage to the display's anti-glare coating, replace a pen if its nibs become worn. You can purchase replacement pens from the Store for SMART Parts (see smarttech.com/support/parts-store).

! **Important**

Use only pens designed for SMART Board GX (V3) series interactive displays. Pens for other SMART products aren't compatible with SMART Board GX (V3) series interactive displays (see [Comparing SMART product pens](#)).

Note

For pen part numbers, refer to the service parts diagrams.

Removing and transporting the display

On occasion, you might need to remove the display from its current wall mount and move it to another location.

To remove the display safely, use two or more trained installers.

⚠ **Warning**

- Do not attempt to move the display by yourself. The display is very heavy.
- Do not move the display by connecting a rope or wire to the handles on the back. The display can fall and cause injury and product damage.

! **Important**

Follow the documentation included with any SMART or third-party mounting hardware.

To remove the display

1. Turn off any connected computers.
2. Turn off the display (see *Turning the display on or off* on page 54).
3. Flick the switch beside the AC power inlet to the OFF (O) position.
4. Remove all accessible cables and connectors.
5. Remove any modules from the OPS slot.

6. Lift the display from its mounting location.

 **Warning**

Do not place the display on a sloping or unstable cart, stand, or table. The display could fall, resulting in injury and severe product damage.

 **Caution**

Do not leave the display face up, face down or upside down for an extended period. This could cause permanent damage to the screen.

7. Remove the mounting brackets.

To transport the display

See *Moving the display to the installation site* on page 16.

Updating system firmware

The display checks for firmware updates automatically when its turned on, provided the display is connected to the internet and the *Disable system updates* setting is disabled (see *System* on page 70). The display notifies you when a firmware update is available.

To make sure the network is configured properly for firmware updates, see *Network* on page 63.

Applying a firmware update

To apply a firmware update

1. After turning on the display, a dialog appears on the screen asking if you want to update the display's firmware.
2. Tap **OK** to update the display's firmware.



Note

The display may restart a number of times when a firmware update is applied.

OR

Tap **Cancel** to update the firmware later.

To apply a firmware update from settings

1. On the Home screen, tap the **Apps** icon  and then tap the **Settings** icon  > **System** > **System update** > **Check for update**.

A message lets you know whether an update is available.

2. If an update is available and you'd like to apply it, tap **OK**. The display applies the firmware update automatically after a short time.

Note

The display may restart a number of times when a firmware update is applied.

Chapter 5 Troubleshooting

Troubleshooting the display and related SMART products

See [Troubleshooting](#) for information on how to resolve a variety of common problems with the display and related SMART products.

Contacting your reseller for additional support

If an issue you're experiencing with the display persists or isn't addressed in this chapter or the knowledge base, contact your authorized SMART reseller (smarttech.com/where) for support.

Your reseller might ask you for the display's serial number. The serial number is on a label on the left side of the display.

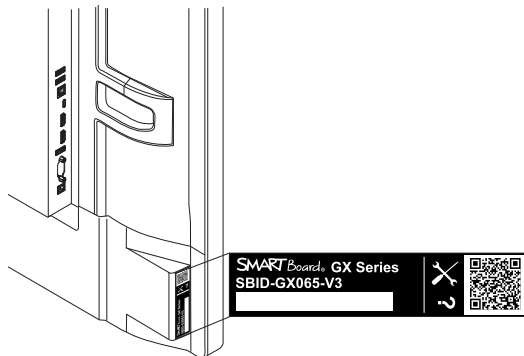



Tip

Scan the QR code on the label to view the SMART Board GX (V3) series interactive display support pages on the SMART website.

Appendix A Adjusting display settings

Accessing the display's settings	62
Exiting the display's settings	63
Network	63
Personalization	66
Input and output	67
Applications	69
System	70
Regulatory Information	75
About	75

Accessing the display's settings

You can access the display's settings from the Home screen by tapping the **Apps** icon  and then tapping the **Settings** icon . You can also press the **Settings** button  on the remote control.

Note

- Open the display's Input settings dialog to access the current input's advanced settings including image, audio, and other settings.
See > Appendix B Adjusting Input settings on page 77.
- If the display's input is set to its Android system and you access the display's settings while viewing input from a connected computer, the input settings dialog appears rather than the main display settings.

The Settings dialog includes the following menu options:

Setting	Function	Notes
Network	Configure network and Wi-Fi settings.	See > <i>Network</i> on the next page.



Setting	Function	Notes
Personalization	Select the wallpaper that appears in the background, configure swipe-up menu options, enable multi-window mode, icon labels, and toolbar display options.	See > <i>Personalization</i> on page 66.
Input and output	Enable touch sounds, select output devices for sound, name input devices, configure external source display settings, and more.	See > <i>Input and output</i> on page 67.
Applications	See which applications are installed, check their permissions and storage, and more.	See > <i>Applications</i> on page 69.
System	Configure system settings including the displayed date and time, keyboard language, lock screen password, startup and shutdown options, adding an email account, file storage options, system update options, and more.	See <i>System</i> on page 70. Note If the system settings lock is enabled, only admins who have the settings passcode can access the system settings. See > <i>Settings lock password</i> on page 72.
Regulatory Information	See an electronic (e-label) version of the GX (V3) display's regulatory information.	See > <i>Regulatory Information</i> on page 75.
About	View information about the display.	See > <i>About</i> on page 75.

Exiting the display's settings

Press the **Home**  button on the front control panel.

Network

Option	Values	Function	Notes
▶ Wi-Fi			

Option	Values	Function	Notes
<ul style="list-style-type: none"> • Wi-Fi 	On Off	Enables or disables connections to Wi-Fi networks.	Turn on Wi-Fi to discover networks.
<ul style="list-style-type: none"> • Select a network 	N/A	Shows information about available Wi-Fi networks.	The display automatically reconnects to a previously connected network unless that connection is removed using <i>Forget</i> .
<ul style="list-style-type: none"> •  icon (Add network) 	Network name Security Advanced Settings	Manually connect to a hidden wireless network.	For the network you're connecting to: <ul style="list-style-type: none"> • Add the SSID. • Select a security protocol and password. • Adjust additional advanced settings, such as Proxy and DHCP settings.
<ul style="list-style-type: none"> •  icon (Wi-Fi preferences) 			
<ul style="list-style-type: none"> • Install certificates 	N/A	Installs an SSL certificate for wireless network access.	N/A
<ul style="list-style-type: none"> • MAC Address 	N/A	Shows the unique media access control (MAC) address for the display's Wi-Fi.	N/A
<ul style="list-style-type: none"> • IP Address 	N/A	Shows the Internet Protocol (IP) address currently assigned to the display's Wi-Fi network interface.	N/A
▶ Ethernet			
<ul style="list-style-type: none"> • Ethernet 	On Off	Enables or disables the display's Ethernet network connection. Note Turning on the Ethernet connection will turn off the display's Wi-Fi connection.	N/A
<ul style="list-style-type: none"> • Obtain IP address automatically 	On Off	Enables the display to obtain an IP address automatically (DHCP).	When the <i>Obtain IP address automatically</i> is disabled, you can change the currently assigned network settings.
<ul style="list-style-type: none"> • MAC address 	N/A	Shows the unique media access control (MAC) address for the display's Ethernet interface.	N/A
<ul style="list-style-type: none"> • IP address 	N/A	Shows the Internet Protocol (IP) address currently assigned to the display's Ethernet network interface.	N/A
<ul style="list-style-type: none"> • Default gateway 	N/A	Information displayed by a router.	N/A
<ul style="list-style-type: none"> • Netmask 	N/A	Information displayed by a router.	N/A
<ul style="list-style-type: none"> • DNS 1 	N/A	Information displayed by a router.	N/A

Option	Values	Function	Notes
• DNS 2	N/A	Information displayed by a router.	N/A
• Proxy	None Manual Automatic proxy configuration	N/A	When <i>Proxy</i> is set to <i>Manual</i> , additional settings appear for entering the <i>Proxy hostname</i> of the proxy server, <i>Proxy port</i> , and <i>Bypass proxy for</i> .
▶ Hotspot			
• Hotspot	On Off	Enables or disables the display's Wi-Fi hotspot. Note Turning on the Wi-Fi hotspot will turn off the display's Wi-Fi connection.	The display must be connected to an Ethernet network to provide a Wi-Fi hotspot. Note The display's Wi-Fi connection will be disabled when providing a Wi-Fi hotspot.
• Hotspot settings	N/A	Enables configuration of the display's hotspot settings.	N/A
• Hotspot name	N/A	Sets the hotspot name.	Keep the default hotspot name or use the display's on-screen keyboard to type a new one.
• Security	None WPA2 PSK	Set an encryption method for the display's Wi-Fi hotspot.	WPA2-PSK is the preferred security option.
• Password	N/A	Set a password for the display's Wi-Fi hotspot.	Use the display's pop-up keyboard to type a password.
• Frequency	2.4 GHz 5 GHz	Set a frequency band for the display's Wi-Fi hotspot. If <i>5 GHz</i> is not selected, a default frequency band of <i>2.4 GHz</i> is used.	The display's <i>5 GHz</i> and <i>2.4 GHz</i> Wi-Fi hotspot frequency bands are not available simultaneously.
▶ Bluetooth			
• Bluetooth	On Off	Enable or disable the display's Bluetooth.	Turn on Bluetooth to view available Bluetooth devices.
• Available devices	N/A	Shows a list of paired Bluetooth devices, their connection status, and a list of available Bluetooth devices.	Choose a paired device to disconnect or forget the device.
•  icon (more options)	Rename this display Show received files	N/A	N/A
▶ VPN			
• VPN switch	On Off	Enable or disable use of a virtual private network (VPN) service with the display.	N/A
• Add a VPN profile	N/A	Create a VPN connection profile.	N/A
• Name (profile name)	N/A	Sets the VPN name.	N/A

Option	Values	Function	Notes
• Type	[Encryption type]	Set an encryption method for the display's VPN connection.	N/A
• Server address	N/A	Enter the fully qualified domain name (FQND) for the VPN server.	N/A
• PPP encryption (MPPE)	On Off	Enables encryption for the VPN.	N/A
• Username	N/A	Set user name for the VPN.	N/A
• Password	N/A	Set a password for the display's VPN.	N/A
• Advanced options	N/A	Set advanced VPN configuration options.	The availability of these options is dependent on the type of VPN selected.
• Always-on VPN	On Off	Configures the VPN to be constantly enabled.	The availability of this option is dependent on the type of VPN selected.
▶ Samba Service			
• Samba switch	On Off	Enable or disable the display's Samba service.	Allows the display to communicate with Windows computers across a network.
• Sign in settings	N/A	User credentials for the Samba service.	N/A

Personalization

Option	Values	Function	Notes
• Wallpaper	N/A	Select the wallpaper that appears in the background.	3840 × 2160 images work best.
• Swipe-up menu options	Select input Bottom toolbar	Sets which menu option appears when swiping up from the bottom edge of any screen.	N/A
• Multi-window mode	On Off	Enables or disables the ability to display more than one app at the same time.	N/A
• Display icon labels	On Off	Show or hide the text labels that identify the icons in the side toolbar.	N/A
• Hide toolbar after:	5 seconds 15 seconds 30 seconds 1 mins 5 mins Always	Sets the time the side and bottom toolbars and Common settings window remain visible before being hidden.	N/A

Input and output

Option	Values	Function	Notes
▶ Sound			
• Touch sounds	On Off	Enables or disables sounds that accompany touch interactions with the display's screen.	N/A
• Audio output settings	Speaker Lineout Auto	Choose whether the display's audio goes to the display's built-in speakers or to an optional external sound system.	This setting switches to <i>Lineout</i> when a 3.5 mm audio cable is plugged into the Audio Out connector on the bottom-rear connector panel. If <i>Auto</i> is selected, the display's audio is sent to an external sound system if one is connected. Otherwise, audio output goes to the display's internal speakers.
▶ Input settings			
• Rename/Enable inputs	N/A	Enables renaming and disabling individual inputs on the display.	N/A
• Enable input renaming	On Off	Enables renaming of individual inputs on the display. Note An input name changes from gray to green when it's editable.	N/A
• PC	On Off	Enables or disables the video input in the display's OPS expansion slot.	This option is available when an OPS PC module is installed in the display's accessory slot.
• Android	On Off	Enables or disables the in-built Android system software.	N/A
• HDMI1	On Off	Enables or disables the HDMI 1 video input on the side connector panel.	N/A
• HDMI2	On Off	Enables or disables the HDMI 2 video input on the side connector panel.	N/A
• HDMI3	On Off	Enables or disables the HDMI 3 video input on the front connector panel.	N/A
• Type-C1	On Off	Enables or disables the USB Type-C input on the side connector panel.	N/A
• Type-C2	On Off	Enables or disables the USB Type-C video input on the front connector panel.	N/A

Option	Values	Function	Notes
<ul style="list-style-type: none"> DP 	On Off	Enables or disables the Display Port video input on the bottom connector panel.	N/A
<ul style="list-style-type: none"> VGA 	On Off	Enables or disables the analog VGA input on the bottom connector panel.	N/A
<ul style="list-style-type: none"> CEC 	On Off	Enables or disables Consumer Electronic Control functions for HDMI video inputs.	<p>HDMI-CEC (Consumer Electronics Control) is a feature of the HDMI standard that allows connected devices to communicate. Enabling the feature allows the display's physical controls and remote control to interact with a CEC-capable device connected to the display with HDMI, such as a DVD player or media device. It also allows the connected device to control the display.</p> <p>Note</p> <p>The degree of support for CEC varies among devices, so the features that can be controlled also varies, depending on the device connected to the display.</p>
<ul style="list-style-type: none"> Wake on active source 	On Off	Enables the display to be turned on by connecting an active video signal to the display.	N/A
<ul style="list-style-type: none"> Switch to active input automatically 	OFF ON SELECT	Automatically switches the input when an active video signal is connected to the display, or displays a user-notification.	N/A
<ul style="list-style-type: none"> No signal power off 	1 minutes 3 minutes 5 minutes 30 minutes 45 minutes 60 minutes (disabled)	Sets the number of minutes before the display goes into an energy saving mode when no video signal is detected.	N/A
▶ External source display settings			
<ul style="list-style-type: none"> HDMI OUT format 	3840 × 2160_ 60HZ 1080P_60HZ	Sets the HDMI out resolution.	<p>Ensure the device that receives the display's HDMI out signal matches the selected output resolution.</p> <p>For best results, make sure the device that receives the display's HDMI out signal uses the same resolution settings as the display.</p>

Option	Values	Function	Notes
<ul style="list-style-type: none"> Advanced HDMI settings 	N/A	Set the HDMI-EDID version for individual digital video inputs. Note HDMI 2.0 is the default.	When HDMI 1.4 is selected, the display presents itself as an HDMI 1.4 compliant device with a video resolution limit of 3840 × 2160 @ 30Hz. When EDID 2.0 is selected, the display presents itself as an HDMI 2.0 compliant device with a video resolution limit of 3840 × 2160 @ 60Hz. Note This setting can be applied differently to each digital video source.
<ul style="list-style-type: none"> PC 	HDMI 1.4 HDMI 2.0	N/A	This option is available when an OPS PC module is installed in the display's accessory slot.
<ul style="list-style-type: none"> HDMI1 	HDMI 1.4 HDMI 2.0	N/A	Side connector panel.
<ul style="list-style-type: none"> HDMI2 	HDMI 1.4 HDMI 2.0	N/A	Side connector panel.
<ul style="list-style-type: none"> HDMI3 	HDMI 1.4 HDMI 2.0	N/A	Front connector panel.
<ul style="list-style-type: none"> TYPE_C1 	HDMI 1.4 HDMI 2.0	N/A	Side connector panel.
<ul style="list-style-type: none"> TYPE_C2 	HDMI 1.4 HDMI 2.0	N/A	Front connector panel.
<ul style="list-style-type: none"> DP 	HDMI 1.4 HDMI 2.0	N/A	Bottom connector panel.

Applications

Option	Values	Function	Notes
▶ Applications			
<ul style="list-style-type: none"> For each application 	N/A	N/A	N/A
<ul style="list-style-type: none"> Uninstall 	N/A	Uninstall the app.	N/A
<ul style="list-style-type: none"> Force Stop 	N/A	Temporarily stop the app from running in the background.	The app will start running again next time its opened.
<ul style="list-style-type: none"> App Notifications 	On Off	Prevent all apps from providing a pop-up message on the screen.	N/A

Option	Values	Function	Notes
<ul style="list-style-type: none"> Permissions 	N/A]	Change permissions for the apps installed on the display, such as what an app is permitted to do and access.	N/A
<ul style="list-style-type: none"> Storage 	N/A	Provides information about the amount of storage an app is using, such as app size, user data, and cache.	N/A
<ul style="list-style-type: none"> Open by default 	N/A	Set an app's open prompt or clear the app's default settings.	N/A
<ul style="list-style-type: none"> Memory 	N/A	View an app's memory usage.	N/A
<ul style="list-style-type: none"> Advanced 	N/A	N/A	N/A
<ul style="list-style-type: none"> Install unknown apps 	N/A	This feature is disabled by default. <div style="border-left: 2px solid orange; padding-left: 5px;"> <p>⚠ Caution</p> <p>SMART cannot accept liability for damages to the display or your personal data that might result from the installation of apps from unknown sources.</p> </div>	Third-party apps cannot be installed when this feature is disabled.
<ul style="list-style-type: none"> Modify system settings 	On Off	Allows an app to modify system settings. <div style="border-left: 2px solid blue; padding-left: 5px;"> <p>Note</p> <p>This feature is not available for most apps.</p> </div>	N/A
<ul style="list-style-type: none"> ⋮ icon (additional settings) 	N/A	N/A	N/A
<ul style="list-style-type: none"> Show System 	N/A	Only third-party apps and desktop apps only are displayed by default. Enabling this option displays the rest of the Android system.	N/A
<ul style="list-style-type: none"> Reset app preferences 	N/A	Restore the default preferences of all applications.	N/A

System

Option	Values	Function	Notes
▶ Date and time			
<ul style="list-style-type: none"> Use 24-hour format 	On Off	Shows the display's time using the 24-hour clock.	Default setting is Disable and shows a 12-hour clock.

Option	Values	Function	Notes
<ul style="list-style-type: none"> Automatic date and time 	On Off	Sets the display's date and time automatically.	This is based on your region and time zone settings. The display synchronizes with network time servers on the internet. When <i>Automatic date and time</i> is disabled, options are available for manually setting the date, time, date format, and time zone.
<ul style="list-style-type: none"> Date format 	[Date formats]	Sets the display's date format.	The default date format is MM/DD/YYYY.
<ul style="list-style-type: none"> Time zone 	[Time zones]	Sets the display's time zone.	N/A
▶ Language and keyboard			
<ul style="list-style-type: none"> Languages 	[Languages]	Sets the language for the display.	N/A
<ul style="list-style-type: none"> Keyboard 	N/A	Enables you to choose which of the installed keyboards and input methods are active.	N/A
<ul style="list-style-type: none"> Virtual keyboard 	N/A	Sets the on-screen keyboard options.	N/A
<ul style="list-style-type: none"> <ul style="list-style-type: none"> Android Keyboard (AOSP) 	On Off	Enables the Android Keyboard (AOSP) on-screen keyboard.	Clicking the enabled keyboard provides additional options, including options to set the keyboard language, appearance, layout, and other advanced settings.
<ul style="list-style-type: none"> <ul style="list-style-type: none"> Google Pinyin Keyboard 	On Off	Enables the Google Pinyin Keyboard on-screen keyboard.	Clicking the enabled keyboard provides additional options, including options to set the keyboard language, appearance, layout, and other advanced settings.
<ul style="list-style-type: none"> Physical keyboard 	[Physical keyboard options]	Sets the physical keyboard options.	N/A
▶ Region			
<ul style="list-style-type: none"> Region 	[Country/regions]	Sets the display's country or region.	Switching the region changes some of the display's behavior, such as the Wi-Fi network channels available for use in that region.
▶ Password			
<ul style="list-style-type: none"> Lock-screen password 		Access options for configuring the lock screen password.	N/A
<ul style="list-style-type: none"> Clear password 	N/A	Clears the lock screen password.	N/A
<ul style="list-style-type: none"> Set password 	N/A	Set a lock screen password.	This option is available when an existing password has been cleared.

Option	Values	Function	Notes
<ul style="list-style-type: none"> Change password 	N/A	Change the four-digit lock screen password.	<p>The passcode is set when turning on the display for the first time.</p> <p>ⓘ Important The display's <i>Screen lock</i> feature is enabled only when a passcode is set.</p>
<ul style="list-style-type: none"> Settings lock password 		Access options for configuring the settings lock password.	N/A
<ul style="list-style-type: none"> Clear password 	N/A	Clears the settings lock password.	N/A
<ul style="list-style-type: none"> Set password 	N/A	Set a password to access certain settings.	The Settings Lock Password is not the same as the user's Lock Screen Password.
<ul style="list-style-type: none"> Change password 	N/A	Change the four-digit settings lock password.	N/A
▶ Startup and shutdown			
<ul style="list-style-type: none"> Startup input 	N/A	Options for configuring startup and shutdown settings.	N/A
<ul style="list-style-type: none"> Startup input 	Last shutdown input PC Android HDMI1 HDMI2 HDMI3 Type-C1 Type-C2 DP VGA	Select which input source is selected on startup. Disabled inputs will not appear in the list.	<p>By default, the input source active at the last shutdown is the selected startup input.</p> <p>The <i>PC</i> option is available when an OPS PC module is installed in the display's accessory slot.</p>
<ul style="list-style-type: none"> Enter Ready mode after startup 	On Off	Enables or disables whether the display enters Ready mode after starting.	When enabled, the display enters Ready mode after starting and no image is displayed on the screen. Pressing the power or home buttons will wake the display.
<ul style="list-style-type: none"> Wake On LAN 	On Off	Enables or disables waking the display when it receives a Magic Packet via the network.	N/A
		<p>Note</p> <p>The display's power consumption may increase when <i>Wake On LAN</i> is enabled.</p>	

Option	Values	Function	Notes
<ul style="list-style-type: none"> Timer Switch 	N/A	Options for configuring timer switch settings.	User-configured startup and shutdown tasks will be listed at the bottom of this section, where you can adjust or delete them individually.
<ul style="list-style-type: none"> Power-off reminder 	On Off	Enables or disables a countdown reminder that appears before the display begins shutting down.	N/A
<ul style="list-style-type: none"> Add startup task 	[Time and date options]	Add a scheduled startup task.	N/A
<ul style="list-style-type: none"> Add shutdown task 	[Time and date options]	Add a scheduled shutdown task.	N/A
▶ Lock control			
<ul style="list-style-type: none"> Lock control 	N/A	N/A	N/A
<ul style="list-style-type: none"> Remote lock 	On Off	Enables or disables the buttons on the display's remote control. (The power button is always enabled.)	N/A
<ul style="list-style-type: none"> Touch lock 	On Off	Enables or disables touch input on the display's screen.	N/A
<ul style="list-style-type: none"> Keypad lock 	On Off	Enables or disables button functionality on the display's front control panel.	N/A
<ul style="list-style-type: none"> Wake lock 	On Off	Enables or disables a lock screen that appears when the display wakes from ready mode.	<p>ⓘ Important</p> <ul style="list-style-type: none"> The display's <i>Screen lock</i> feature must be enabled before you can enable the <i>Wake lock</i> feature. <p>See > <i>Set password</i> on page 71</p> <ul style="list-style-type: none"> A lock screen will only appear when the display wakes from ready mode and not when turned on. <p>Press the power button on the front control panel to put the display in Ready mode or to wake the display.</p>
▶ Pixel shift			
<ul style="list-style-type: none"> Pixel shift 	Off Interval 2 mins Interval 3 mins Interval 5 mins Interval 30 mins Interval 60 mins	When the interval timer is enabled, the display's image will move up and down momentarily to reduce the risk of image burn-in.	N/A
▶ Email			

Option	Values	Function	Notes
• Add Account	[Mail Settings]	Add an email account to the display.	N/A
▶ Storage			
• Internal storage space	N/A	Shows how much storage memory is available and how much is currently in use.	Delete saved documents, image, or video files, or uninstall third-party applications if available storage memory is low.
• Clean up app data	N/A	Cleans app data.	N/A
▶ System update			
• Disable system updates	On Off	Enables or disables the ability to update the display's system software	This feature is disabled by default.
• Current version	N/A	Shows the current version of the display's firmware.	N/A
• Check for update	N/A	Manually check for updates to the display's firmware.	If an update is available, a message appears on screen and asks whether the user wishes to install it. Note The display must be connected to the internet to check for system software updates. Check the display's network settings. See > <i>Network</i> on page 63.
▶ Factory reset			
• Factory reset	Cancel Confirm	Resets all options to their default values.	Only administrators should reset the display to factory settings
▶ Security			
• Credential storage	N/A	You can view installed trusted system and user credentials (certificates), control the enabling status of these credentials, and view the details of each certificate.	N/A
• Trusted credentials	N/A	View and enable or disable trusted credentials.	N/A
• System	N/A	Enable or disable trusted system credentials.	N/A
• User	N/A	Enable or disable trusted user credentials.	N/A
• User credentials	N/A	View and modify user credentials.	N/A
• Install from storage	N/A	Install a certificate from local storage or a USB drive.	N/A

Option	Values	Function	Notes
<ul style="list-style-type: none"> Clear credentials 	N/A	Removes security certificates from the display.	<p>⚠ Caution</p> <p>Removing security certificates may affect the performance of some applications.</p>
<ul style="list-style-type: none"> Install from unknown sources 			
<ul style="list-style-type: none"> Unknown sources 	On Off	Allow the installation of apps from unknown sources.	<p>The display and your data are more vulnerable to attack by applications from unknown sources.</p> <p>⚠ Caution</p> <p>SMART is not responsible for any damage to the display or loss of your data that might result from using applications from unknown sources.</p> <p>Only administrators should install applications from unknown sources.</p>

Regulatory Information

View an electronic (e-label) version of the GX (V3) display's regulatory information.

About



Option	Values	Function	Notes
<ul style="list-style-type: none"> Legal information 	N/A	N/A	N/A
<ul style="list-style-type: none"> Third-party licenses 	N/A	Shows the third-party licenses.	N/A
<ul style="list-style-type: none"> Open-source licenses 	N/A	Shows the open source licenses.	N/A
<ul style="list-style-type: none"> System WebView licenses 	N/A	Shows the system WebView licenses.	N/A
<ul style="list-style-type: none"> Display part number 	N/A	Shows the display's part number.	N/A
<ul style="list-style-type: none"> Model number 	N/A	Shows the display's model number.	N/A
<ul style="list-style-type: none"> Android version 	N/A	Shows the current version of the display's Android operating system.	N/A
<ul style="list-style-type: none"> Kernel version 	N/A	Shows the display's Android Kernel version.	N/A

Option	Values	Function	Notes
<ul style="list-style-type: none">• Build number	N/A	Shows build information for the current version of the display's system firmware.	N/A
<ul style="list-style-type: none">• Version	N/A	Shows the current version of the display's system firmware.	SMART Support teams might request this information if you contact them.
<ul style="list-style-type: none">• Touchkit version	N/A	Shows the current version of the display's touch kit.	SMART Support teams might request this information if you contact them.
<ul style="list-style-type: none">• SRM version	N/A	Shows the current version of the display's SMART Remote Management software.	SMART Support teams might request this information if you contact them.
<ul style="list-style-type: none">• Memory Info	N/A	Shows how much RAM is installed in the display	N/A

Appendix B Adjusting Input settings

Opening the Input settings menu	77
Exiting the Input settings menu	77
Source settings	77
Advanced settings	78

Opening the Input settings menu

1. Open the **Toolbar** by tapping one of the side Toolbar buttons  on either sides of the screen.
2. Tap the **Input**  icon.

The Common Settings dialog appears.

Tip

You can also open the Inputs menu by pressing the **Input** button  on the remote control when the display's input is set to Android.

Exiting the Input settings menu

Press the **Home**  button on the front control panel.

Source settings

Option	Values	Function	Notes
▶ Inputs			

Option	Values	Function	Notes
<ul style="list-style-type: none"> Select an input 	PC Android HDMI1 HDMI2 HDMI3 Type-C1 Type-C2 DP VGA	Select a connected computer or other device's input to view on the display. Note The PC input appears only when an OPS PC module is installed in the display's accessory slot.	A green circle  appears around the currently selected input (PC, Android, HDMI1, HDMI2, HDMI3, Type-C1, Type-C2, DP, or VGA). Inputs with a connected source have a green dot beside the input name, rather than a gray dot. The input name also appears in green text rather than gray when an input is connected. Note Disabled inputs do not appear in the list of available inputs.
<ul style="list-style-type: none"> Screen brightness 	Range slider	Sets the overall brightness of the image.	N/A
<ul style="list-style-type: none"> Volume 	Range slider	Sets the display's volume.	N/A

Advanced settings

Access the current input's advanced settings by tapping the three dots **•••** that appear in upper right corner of the input settings menu screen. The current input is surrounded by a green circle .

Tip

You can also open the Advanced settings menu by pressing the **Settings** button  on the remote control when viewing any input other than Android.

Option	Values	Function	Notes
▶ Audio			
Note The following settings are applicable to all inputs.			
<ul style="list-style-type: none"> Volume 	1 to 100	Sets the display's volume	N/A
<ul style="list-style-type: none"> Bass 	-5 to 5	Sets the bass level.	This setting is only adjustable when Custom audio mode is enabled (see Audio modes below).
<ul style="list-style-type: none"> Treble 	-5 to 5	Sets the treble level.	This setting is only adjustable when Custom audio mode is enabled (see Audio modes below).
<ul style="list-style-type: none"> Balance 	-50 to 50	Sets the L/R balance of the display's built-in speakers.	N/A

Option	Values	Function	Notes
• Audio modes			
• Standard	On Off	This is the default audio mode	N/A
• Meeting	On Off	An audio mode optimized for meeting rooms, with slightly reduced bass.	N/A
• Class	On Off	An audio mode optimized for classrooms, with slightly reduced bass and slightly increased treble.	N/A
• Custom	On Off	An audio mode that allows full user control of bass and treble adjustments.	N/A
• Mute	On Off	Mutes the display's audio system.	N/A
▶ Screen			
• Pixel shift	On Off	If enabled, the display's image will move up and down momentarily to reduce the risk of image burn-in. To set timing options, see <i>Pixel Shift</i> in the <i>System</i> on page 70 section of display settings).	N/A
• Eye Care	On Off	Changes the screen settings to reduce the brightness and amount of blue light in the image.	N/A
• AutoLight	On Off	Detects the ambient light in the room and automatically adjusts the screen brightness.	N/A
• SaveEnergy	On Off	Reduces the screen brightness of the display to save power.	N/A
• Image scaling			
Note			
The following settings are only available when <i>DP</i> or <i>VGA</i> inputs are selected.			
• 4:3	On Off	Sets the screen image's aspect ratio to 4:3	N/A
• 16:9	On Off	Sets the screen image's aspect ratio to 16:9	N/A
• PTP	On Off	This setting may help if the 16:9 setting causes the screen image's edges to be clipped.	N/A
• Auto	On Off	Enables the display to automatically choose the optimal image scaling for the source video signal. This is the default setting.	This is the recommended setting for image scaling.

Option	Values	Function	Notes
► Display			
Notes			
<ul style="list-style-type: none"> This display uses continuous current dimming to prevent flicker at low brightness settings The following settings are applicable to all inputs. 			
• Brightness	1 to 100	Sets the overall brightness of the image.	N/A
• Contrast	1 to 100	Sets the difference in brightness between the lightest and darkest parts of the image.	N/A
• Hue	1 to 100	Sets the hue (color) of the image.	This setting is available only when <i>Custom</i> display mode is enabled and is not available for all inputs.
• Sharpness	1 to 100	Sets the sharpness of the image.	This setting is available only when <i>Custom</i> display mode is enabled and is not available for all inputs.
• Display modes			
• Standard	On Off	The default display mode, for optimal performance.	N/A
• Bright	On Off	A brighter image mode that may use more power.	Different shades of light gray may be harder to see in this mode.
• Soft	On Off	A softer image mode with slightly reduced contrast.	N/A
• Custom	On Off	An image mode that allows users to customize the image brightness, contrast, hue, and sharpness.	N/A
• Color modes			
• Standard	On Off	The default color mode.	N/A
• Cold	On Off	Raises the screen image's color temperature.	N/A
• Warm	On Off	Lowers the screen image's color temperature.	N/A
• More ⋮ icon (additional settings)	N/A	Manually adjust the red, green, and blue color channels individually. You can also reset the white balance to its default setting.	N/A
► Adjust			
Note			
The following settings apply only to VGA inputs.			
• H Position	1 to 100	Manually set the image's relative horizontal position on the display.	N/A

Appendix B Adjusting Input settings

Option	Values	Function	Notes
<ul style="list-style-type: none">V Position	1 to 100	Manually set the image's relative vertical position on the display.	N/A
<ul style="list-style-type: none">Phase	1 to 36	Adjusts the phase of the analog video signal.	Adjusting this setting can help compensate for indistinct colors on analog video inputs.
<ul style="list-style-type: none">AUTO PHASE	N/A	Enables the display to try to detect the best phase setting for the current analog video signal.	N/A

Appendix C **Managing the display using RS-232**

Configuring the serial interface settings	83
Commands and responses	85
Power state commands	87
Input commands	88
Brightness commands	88
Freeze commands	89
Screen shade commands	89
Volume commands	89
Mute commands	89
Firmware version commands	90
Model number commands	90
Serial number commands	90
Part number commands	90
Asynchronous messages	90

You can connect an RS-232 cable from a computer or a control system's serial output to the display's RS-232 in connector to remotely select video inputs, turn the display on or off, and get information about the display's current settings, such as volume and power state.

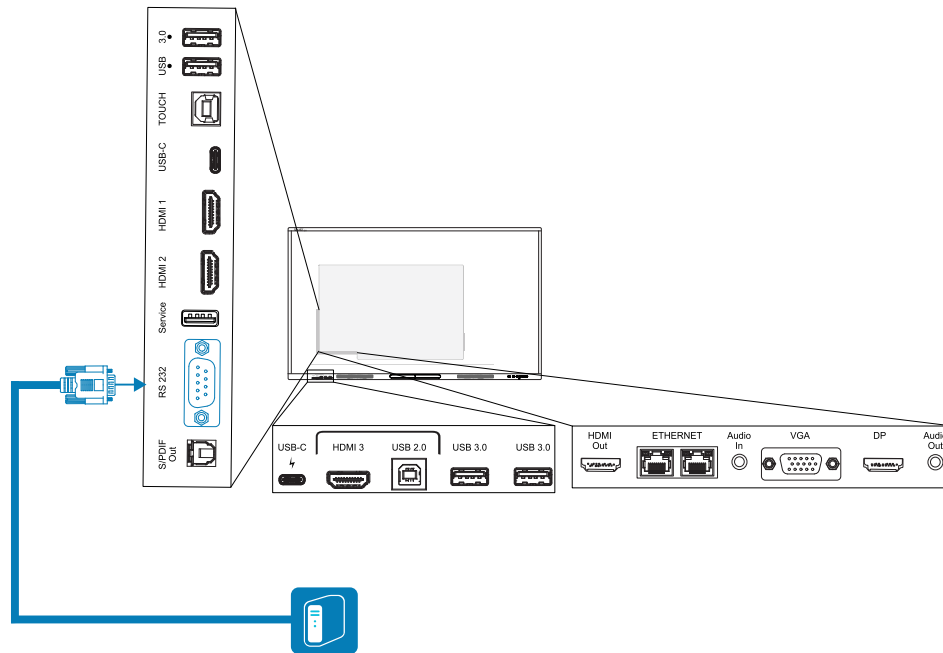

! Important

Use only a standard RS-232 cable. Do not use a null modem cable. Null modem cables typically have ends of the same type.

Tip

SMART also offers SMART Remote Management cloud-based device-management software, which you can use to manage SMART Board interactive displays with iQ and devices running Windows, Chrome™ OS, Android, and iOS operating systems. For more information, see [SMART Remote Management](#).

Configuring the serial interface settings

Configure the computer or control system's serial interface before sending commands to the display.

1. Turn on the display.
2. If you're using a terminal application on a computer, activate local echo to see what you're typing and sending to the display.
3. Configure the serial interface settings with the following values:

Baud rate	19200
Data length	8
Parity bit	None
Stop bit	1

4. Send a carriage return character (<CR>) to the display. The display will show a command prompt (>) to indicate that the display can now accept commands.

Note

- If you're using a terminal application on a computer, pressing ENTER should send a carriage return character (<CR>) but might also send a line feed character (<LF>), depending on your terminal application configuration.
- If no message appears or an error message appears, the serial interface isn't configured correctly. Repeat steps 3 and 4.
- If you're using a terminal app on a PC, keep your screen legible by configuring the terminal app's settings to add a line feed <LF> after sending or receiving a carriage return <CR>. For example, in the PUTTY app, enable terminal option *Implicit LF in every CR*.

When using a control system program instead of terminal program, all the lines output from the display are preceded by a carriage return character (<CR>) and line feed character (<LF>) and then followed by a carriage return character (<CR>) and line feed character (<LF>), as shown in the example below. Refer to an [ASCII table](#) for more information about character codes if needed.

```
>set volume=0<CR>
<CR><LF>
volume=0<CR><LF>
>
```

Commands and responses

To access display information or to adjust display settings using the room control system, send a command after the command prompt (>), send a carriage return character or press ENTER, and then wait for the response from the display. Responses are preceded by a carriage return character (<CR>) and line feed character (<LF>) and then followed by a carriage return character (<CR>) and line feed character (<LF>). If no command prompt is present, send a carriage return character to the display. If the display is ready to receive commands, it will show a command prompt (>) when the carriage return is received. See the example below.

Correct

```
>get volume
volume=55
>
```

In the example below, the user used =-50 instead of -50.

Incorrect

```
>set volume=-50
invalid cmd: setvolume=-50
>
```

Notes

- Use ASCII formatted commands.
- Commands aren't case-sensitive and extra spacing is ignored.

- In many terminal applications on a computer, you can use the BACKSPACE key when typing commands.
- Review each entry carefully before sending a command to the display.
- Don't send another command until you receive the response and the next command prompt (>). If no command prompt is present, send a carriage return character (<CR>) to the display. If the display is ready to receive commands, it will show a command prompt after receiving the carriage return.

To retrieve a setting's current value

Use a `get` command.

This example shows how to get the volume:

```
>get volume  
volume=55  
>
```

To assign a value to a setting

Use a `set` command.

This example sets the volume to 65:

```
>set volume=65  
volume=65  
>
```

To increase or decrease the value of a setting

Use the `set` command to increase or decrease the value by a designated number.

This example increases the volume by 5:

```
>set volume+5
volume=70
>
```

This example decreases the volume by 15:

```
>set volume-15
volume=55
>
```

Power state commands

Get command	Set command	Response
<code>get powerstate</code>	<code>set powerstate[Value]</code> Where [Value] is one of the following: <ul style="list-style-type: none"> • =on • =ready • =powersave 	<code>powerstate=[Value]</code> Where [Value] is one of the following: <ul style="list-style-type: none"> • on • ready • powersave

The display has three power states:

Power state	Description
ON	The display is in normal operating mode.
READY	The screen is off, but the display is ready to turn on when one of the following occurs: <ul style="list-style-type: none"> • A user presses the Power button  on the front control panel or the remote control. • You send the <code>set powerstate=on</code> command. • The display receives a video signal.

Power state	Description
POWERSAVE	<p>The screen is off, and the display is in a very low power state. The display enters READY or ON state when one of the following occurs:</p> <ul style="list-style-type: none"> A user presses the Power button  on the front control panel or the remote control. You send the <code>set powerstate=ready</code> or <code>set powerstate=on</code> command. <p>This power state is the default energy saving mode for displays set to an EU location.</p> <p>Note The EU uses “Standby” to describe this power state.</p>

Input commands

Get command	Set command	Response
<code>get input</code>	<code>set input[Value]</code> Where [Value] is one of the following: <ul style="list-style-type: none"> <code>=hdmi1</code> <code>=hdmi2</code> <code>=hdmi3</code> <code>=vga</code> <code>=ops</code> <code>=type-c1 [or usbc1]</code> <code>=type-c2 [or usbc2]</code> <code>=dp</code> <code>=android</code> 	<code>input=[Value]</code> Where [Value] is one of the following: <ul style="list-style-type: none"> <code>hdmi1</code> <code>hdmi2</code> <code>hdmi3</code> <code>vga</code> <code>ops</code> <code>=type-c1 [or usbc1]</code> <code>=type-c2 [or usbc2]</code> <code>dp</code> <code>android</code>

Brightness commands

Get command	Set command	Response
<code>get brightness</code>	<code>set brightness[Value]</code> Where [Value] is one of the following: <ul style="list-style-type: none"> <code>+ [Value]</code> <code>- [Value]</code> <code>= [0-100]</code> 	<code>brightness=[Value]</code> Where [Value] is a number between 0 and 100

Freeze commands

Get command	Set command	Response
get videofreeze	set videofreeze[Value] Where [Value] is one of the following: <ul style="list-style-type: none"> • =on • =off 	videofreeze=[Value] Where [Value] is one of the following: <ul style="list-style-type: none"> • on • off

Screen shade commands

Get command	Set command	Response
get screenshade	set screenshade[Value] Where [Value] is one of the following: <ul style="list-style-type: none"> • =on • =off 	screenshade=[Value] Where [Value] is one of the following: <ul style="list-style-type: none"> • on • off

Volume commands

Get command	Set command	Response
get volume	set volume[Value] Where [Value] is one of the following: <ul style="list-style-type: none"> • +[Value] • -[Value] • =[0-100] 	volume=[Value] Where [Value] is a number between 0 and 100

Mute commands

Get command	Set command	Response
get mute	set mute[Value] Where [Value] is one of the following: <ul style="list-style-type: none"> • =on • =off 	mute=[Value] Where [Value] is one of the following: <ul style="list-style-type: none"> • on • off

Firmware version commands

Get command	Response
get fwversion	fwversion=[Value] Where [Value] is the firmware version.

Model number commands

Get command	Response
get modelnum	modelnum=[Value] Where [Value] is one of the following: <ul style="list-style-type: none"> • sbid-gx065-v3 • sbid-gx075-v3 • sbid-gx086-v3

Serial number commands

Get command	Response
get serialnum	serialnum=[Value] Where [Value] is the serial number.

Part number commands

Get command	Response
get partnum	partnum=[Value] Where [Value] is the part number, including the revision.

Asynchronous messages

The display sends an asynchronous message when the front control panel, Settings app, or remote control are used to change a display's setting that can be controlled by RS-232. The display will also send an asynchronous message if the display's power state changes. Asynchronous messages are identified by a pound sign (#) before the message and aren't followed by a command prompt (>).

Change	Asynchronous message
display power state	<pre>#powerstate=[Value]</pre> Where [Value] is one of the following: <ul style="list-style-type: none"> • on • ready • powersave
Input selection	<pre>#input=[Value]</pre> Where [Value] is one of the following: <ul style="list-style-type: none"> • =hdmi1 • =hdmi2 • =hdmi3 • =vga • =ops • =type-c1 [or usbc1] • =type-c1 [or usbc1] • =dp • =android
Brightness	<pre>#brightness=[Value]</pre> Where [Value] is a number between 5 and 100
Freeze frame	<pre>#videofreeze=[Value]</pre> Where [Value] is one of the following: <ul style="list-style-type: none"> • on • off
Screen shade	<pre>#screenshade=[Value]</pre> Where [Value] is one of the following: <ul style="list-style-type: none"> • on • off
Volume increase or decrease	<pre>#volume=[Value]</pre> Where [Value] is a number between 0 and 100
Volume mute	<pre>#mute=[Value]</pre> Where [Value] is one of the following: <ul style="list-style-type: none"> • on • off

Appendix D Enrolling the display in SMART Remote Management

Your SMART Board GX series interactive display has a built-in feature that enables you to enroll the display with your organization's SMART Remote Management account. When you enroll the display, you can use SMART Remote Management to centrally control the display's features and settings, such as:

- blocklists and allowlists
- Wi-Fi
- wallpaper
- lock screen
- available apps

See > support.smarttech.com/docs/enrollingsrm

Appendix E Disabling and reenabling the embedded OS and other inputs



Admins can disable specific inputs, including the embedded Android OS. This is ideal for environments that use only connected devices. Admins can also re-enable specific inputs.

You cannot enable or disable the Android input or any other input unless a Settings Lock Password has been enabled.

See > *System* on page 70.

Disabling inputs

To disable the embedded OS

1. Open the display's settings from the Home screen by tapping the **Apps** icon  and then tapping the **Settings** icon . You can also press the **Settings** button  on the remote control.

The display's *Settings* dialog appears.

Note

If the *Settings lock password* is enabled, you must enter the password before you can change the source settings.

2. In **Input and output** > **Input settings** > **Rename/enable inputs**, disable the **Android** input.

If the Settings Lock Password is not enabled, a dialog box appears prompting you to configure a password. Disable the Android input after configuring a password.

3. Tap **Restart**.

Note

When Android is disabled, the Home button is also disabled on the front control panel and the remote control.



To disable other inputs

To disable other inputs, select a different input under *Rename/enable inputs* and follow the same process.

See > *System* on page 70.

Reenabling inputs

To reenable the embedded OS

1. Open the display's settings by tapping either of the Side Toolbar menu buttons  (located either side of the screen) and then tap the **Settings** icon .

The display's *Settings* dialog appears.

Note

If the *Settings lock password* is enabled, you must enter the password before you can change the source settings.

See > *System* on page 70.

2. In **Input and output** > **Input settings** > **Rename/enable inputs**, enable the **Android** input.
3. Tap **Restart**.

The display restarts.

To reenable other inputs

To reenable other inputs, select a different input under *Rename/enable inputs* and follow the same process.

See > *System* on page 70.



Certification and compliance

Note

For the purposes of certification, the SMART Board GX (V3) series of displays are identified as models IDGX65-2, IDGX75-2, and IDGX86-2.

Accessing the display's e-label information

An electronic (e-label) version of the GX (V3) display's regulatory information is available in the display's settings.

From the Home screen, tap the **Apps** icon  > **Settings** icon  > **Regulatory Information**.

For more information, see *Regulatory Information* on page 75.

For more information, see the *SMART Board GX (V3) series interactive displays user guide* (docs.smarttech.com/kb/171903)

Federal Communication Commission interference statement

FCC

Supplier's Declaration of Conformity

47 CFR § 2.1077 Compliance Information

Unique Identifier: IDGX65-2, IDGX75-2, IDGX86-2

Responsible Party – U.S. Contact Information

SMART Technologies Inc.

2401 4th Ave, 3rd Floor

Seattle, WA 98121

compliance@smarttech.com

This device complies with Part 15 of the FCC Rules. Operation is subject to the following two conditions:

1. This device may not cause harmful interference, and
2. this device must accept any interference received, including interference that may cause undesired operation.

Note

This equipment has been tested and found to comply with the limits for a Class A digital device, pursuant to part 15 of the FCC Rules. These limits are designed to provide reasonable protection against harmful interference when the equipment is operated in a commercial environment. This equipment generates, uses, and can radiate radio frequency energy and, if not installed and used in accordance with the instruction manual, may cause harmful interference to radio communications. Operation of this equipment in a residential area is likely to cause harmful interference in which case the user will be required to correct the interference at his own expense.

Caution

Any changes or modifications not expressly approved by the party responsible for compliance could void the user's authority to operate this equipment.

Restriction

Operations in the 5.15-5.25 GHz band are restricted to indoor usage only.

IEEE 802.11b or 802.11g operation of this product in the USA is firmware limited to channels 1 through 11.

Radiation exposure statement

This equipment complies with FCC radiation exposure limits set forth for an uncontrolled environment. This equipment should be installed and operated with minimum distance of 20 cm between the antenna of this device and all nearby persons. This transmitter must not be co-located or operated in conjunction with any other antenna or transmitter.

Innovation, Science and Economic Development Canada statement

This device complies with RSS-210 of the Innovation, Science and Economic Development Canada Rules. Operation is subject to the following two conditions:

1. This device may not cause harmful interference, and
2. this device must accept any interference received, including interference that may cause undesired operation.

⚠ Caution

- (i) the device for operation in the band 5150–5250 MHz is only for indoor use to reduce the potential for harmful interference to co-channel mobile satellite systems;
- (ii) the maximum antenna gain permitted for devices in the bands 5250–5350 MHz and 5470–5725 MHz shall comply with the e.i.r.p. limit; and
- (iii) the maximum antenna gain permitted for devices in the band 5725–5825 MHz shall comply with the e.i.r.p. limits specified for point-to-point and non point-to-point operation as appropriate.
- (iv) Users should also be advised that high-power radars are allocated as primary users (i.e., priority users) of the bands 5250–5350 MHz and 5650–5850 MHz and that these radars could cause interference and/or damage to LE-LAN devices.

Radiation exposure statement

This equipment complies with ISED radiation exposure limits set forth for an uncontrolled environment. This equipment should be installed and operated with minimum distance of 20 cm between the antenna of this device and all nearby persons. This transmitter must not be co-located or operated in conjunction with any other antenna or transmitter.

Innovation, Science et Développement économique Déclaration du Canada

Cet appareil est conforme à la norme ISED CNR-210 pour les appareils radio agréés. Son fonctionnement est soumis aux deux conditions suivantes:

1. le dispositif ne doit pas produire de brouillage préjudiciable, et
2. ce dispositif doit accepter tout brouillage reçu, y compris un brouillage susceptible de provoquer un fonctionnement indésirable.

⚠ Avertissement

- (i) les dispositifs fonctionnant dans la bande 5 150–5 250 MHz sont réservés uniquement pour une utilisation à l'intérieur afin de réduire les risques de brouillage préjudiciable aux systèmes de satellites mobiles utilisant les mêmes canaux;
- (ii) le gain maximal d'antenne permis pour les dispositifs utilisant les bandes 5 250–5 350 MHz et 5 470–5 725 MHz doit se conformer à la limite de p.i.r.e.;
- (iii) le gain maximal d'antenne permis (pour les dispositifs utilisant la bande 5 725–5 825 MHz) doit se conformer à la limite de p.i.r.e. spécifiée pour l'exploitation point à point et non point à point, selon le cas.

- (iv) De plus, les utilisateurs devraient aussi être avisés que les utilisateurs de radars de haute puissance sont désignés utilisateurs principaux (c.-à-d., qu'ils ont la priorité) pour les bandes 5 250–5 350 MHz et 5 650–5 850 MHz et que ces radars pourraient causer du brouillage et/ou des dommages aux dispositifs LAN-EL.

Déclaration d'exposition aux radiations

Cet équipement est conforme aux limites d'exposition aux rayonnements ISED établies pour un environnement non contrôlé. Cet équipement doit être installé et utilisé avec un minimum de 20 cm de distance entre la source de rayonnement et votre corps. Cet émetteur ne doit pas être co-implantés ou exploités conjointement avec une autre antenne ou émetteur.

EU Declaration of Conformity

Hereby, SMART Technologies ULC declares that the radio equipment type Interactive Display **IDGX65-2**, **IDGX75-2**, **IDGX86-2** and the **PCM11** are in compliance with Directive 2014/53/EU.

The full text of the EU declaration of conformity is available at the following Internet address: smarttech.com/compliance

⚠ Warning

Operation of this equipment in a residential environment could cause radio interference.

The frequency band and the maximum transmitted power in EU are listed below:

Regulatory models: IDGX65-2, IDGX75-2, IDGX86-2

Transmitting Band (MHz)	Maximum Transmit Power dBm
2402–2483.5	19.5
5150–5350	21
5470–5725	20
5725–5850	14

Regulatory model: PCM11

Transmitting Band (MHz)	Maximum Transmit Power dBm
2402–2483.5	20
5150–5350	23
5470–5725	23
5725–5850	13.9

Disabling and reenabling the embedded OS and other inputs

Restrictions in:

AT/BE/BG/CZ/DK/EE/FR/DE/IS/IE/IT/EL/ES/CY/LV/LI/LT/LU/
HU/MTNL/NO/PL/PT/RO/SI/SK/TR/FI/SE/CH/UK/HR –
5150MHz-5350MHz is for indoor use only.

For optimal performance any support equipment connected to this device must be CE compliant.

Hardware environmental compliance

SMART Technologies supports global efforts to ensure that electronic equipment is manufactured, sold, and disposed of in a safe and environmentally friendly manner.

Waste Electrical and Electronic Equipment (WEEE) and batteries	Electrical and electronic equipment and batteries contain substances that can be harmful to the environment and to human health. The crossed-out wheeled bin symbol indicates that products should be disposed of in the appropriate recycling stream and not as regular waste.	
Batteries	<p>⚠ Caution</p> <p>There is a risk of fire or explosion if a battery is replaced by an incorrect type. Dispose of used batteries promptly. Follow handling instructions on coin cell packaging. Recycle or dispose of used batteries according to local guidelines.</p> <p>The display contains a CR2032 coin cell battery (not user accessible). The remote contains two AAA batteries. Recycle or dispose of batteries properly.</p>	
REACH Regulation	<p>This product may contain substances that are candidate SVHCs under the EU REACH Regulation (EC) 1907/2006.</p> <p>See > echa.europa.eu/scip-database</p>	
Perchlorate material	<p>The coin cell battery contains perchlorate material. Special handling may apply.</p> <p>See > dtsc.ca.gov/hazardouswaste/perchlorate</p>	
More information	<p>See > smarttech.com/compliance</p>	

SMART Technologies

smarttech.com/support

smarttech.com/contactsupport

docs.smarttech.com/kb/171903