

ViewSonic®



XG350R-C

Display

User Guide

IMPORTANT: Please read this User Guide to obtain important information on installing and using your product in a safe manner, as well as registering your product for future service. Warranty information contained in this User Guide will describe your limited coverage from ViewSonic Corporation, which is also found on our web site at <http://www.viewsonic.com> in English, or in specific languages using the Regional selection box in the upper right corner of our website. "Antes de operar su equipo lea cuidadosamente las instrucciones en este manual"

Model No. VS17553
P/N: XG350R-C

Thank you for choosing ViewSonic

As a world leading provider of visual solutions, ViewSonic is dedicated to exceeding the world's expectations for technological evolution, innovation, and simplicity. At ViewSonic, we believe that our products have the potential to make a positive impact in the world, and we are confident that the ViewSonic product you have chosen will serve you well.

Once again, thank you for choosing ViewSonic !



Contents

1. Cautions and Warnings	1
2. Getting Started	4
2-1. Package Contents	5
2-2. The Exterior of the Monitor	6
2-3. Hardware Installation	7
2-4. Quick Installation	14
2-5. Power On	16
2-6. Driver Installation (Windows 10 Setup)	17
3. Adjusting the Screen Image	19
3-1. Setting the Timing Mode	19
3-2. Using the Control Panel	20
4. OSD Menu Introduction	23
4-1. OSD Menu Tree	23
4-2. OSD Menu Explanation	31
4-3. Advanced Settings for Gamers	42
4-4. Monitor Setting Management	46
5. Specifications	48
6. Troubleshooting	51
7. Cleaning and Maintenance	52
Safe Cleaning Practices	52

8. Compliance Information 54

- 8-1. FCC Compliance Statement 54
- 8-2. Industry Canada Statement 55
- 8-3. Declaration of RoHS2 Compliance 55
- 8-4. Indian Restriction of Hazardous Substances 57
- 8-5. Product Disposal at End of Product Life 57

9. Copyright Information..... 58

10. Service Information..... 59

- Product Registration 59
- Customer Service 60
- Limited Warranty..... 63
- Mexico Limited Warranty 68

1. Cautions and Warnings

1. Read these instructions completely before using the equipment.
2. Keep these instructions in a safe place.
3. Heed all warnings and follow all instructions.
4. Sit at least 18" / 45cm from the monitor.
5. When installing the monitor, please leave 10cm of open space around the monitor for ventilation safety purposes.
6. Always handle the display with care when moving it.
7. Exercise caution when removing the rear cover of the monitor. This monitor contains high-voltage parts.
8. Do not use this equipment near water. To reduce the risk of fire or electric shock, do not expose the monitor to rain or moisture.
9. Avoid exposing the monitor to direct sunlight or other sources of sustained heat. Do not install near any heat sources such as radiators, heat registers, stoves, or other devices (including amplifiers) that may increase the temperature of the monitor to dangerous levels.
10. Clean with a soft, dry cloth. If further cleaning is required, see "Cleaning the Display" in this guide for further instructions.
11. Avoid touching the screen. Skin oils are difficult to remove.
12. Do not touch, rub or apply pressure to the monitor screen, as it may permanently damage the screen.
13. Place the monitor in a well-ventilated area. Do not place anything on the display that prevents heat dissipation.
14. Do not place heavy objects on the display, video cable, or power cord.

15. If smoke appears, an abnormal noise, or a strange odor is present, immediately switch the display off and call your dealer or ViewSonic. It is dangerous to continue using the display.
16. Do not attempt to circumvent the safety provisions of the polarized or grounding-type plug. A polarized plug has two blades with one wider than the other. A grounding type plug has two blades and a third grounding prong. The wide blade and the third prong are provided for your safety. If the plug does not fit into your outlet, obtain an adaptor and do not attempt to force the plug into the outlet.
17. When connecting to a power outlet, DO NOT remove the ground prong. Please ensure grounding prongs are NEVER REMOVED.
18. Protect the power cord from being treaded upon or pinched, particularly at the plug, and at the point where it emerges from the equipment. Be sure that the power outlet is located near the equipment so that it is easily accessible.
19. Only use attachments/accessories specified by the manufacturer.
20. Use only with the cart, stand, tripod, bracket, or table specified by the manufacturer, or sold with the equipment. When a cart is used, use with caution when moving the cart/equipment combination to avoid injury from tipping over.
21. Unplug this equipment when it will be unused for long periods of time.



22. Refer all servicing to qualified service personnel. Service will be required when the unit has been damaged in any way, such as: if the power-supply cord or plug is damaged, if liquid is spilled onto or objects fall into the unit, if the unit is exposed to rain or moisture, or if the unit does not operate normally or has been dropped.
23. Excessive sound pressure from ear-/headphones can cause hearing damage /hearing loss.
24. Adjustment of the volume control as well as the equalizer may increase the ear-/ headphones output voltage and therefore, the sound volume level.
25. The factors influencing the ear-/headphones output other than those specified by the manufacturer (e.g. operating system, equalizer software, firmware, driver) may increase the ear-/ headphone output voltage and therefore, the sound volume level.

2. Getting Started

Should problems arise and the product you have purchased needs to be returned for any reason, please keep the original packaging, registration form, and receipt. Having these items will make it easier for you to verify your product and repair, refund and/or return your product to you.

If you have any problems with your product or questions that have not been addressed in the User Guide, please contact customer service for help.

Important! Save the original box and all packing material for your future shipping needs.

NOTE: The word “Windows” in this user guide refers to Microsoft Windows operating system.

2-1. Package Contents

Your monitor package includes:

- Monitor
- Power cord
- HDMI cable
- DP cable¹
- USB cable
- Quick Start Guide

NOTE:

¹ The video cables included in your package may vary depending on your country. Please contact your local reseller for more information.

2-2. The Exterior of the Monitor

A. Front

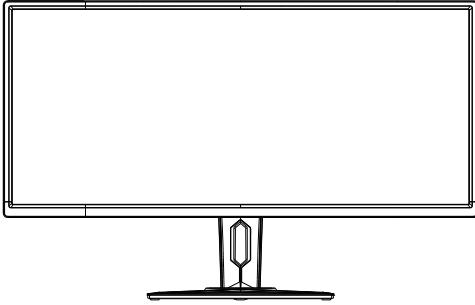

B. Left and Right

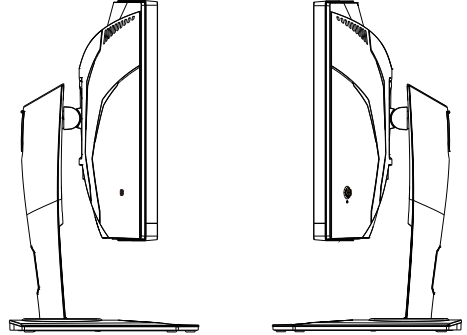

C. Rear

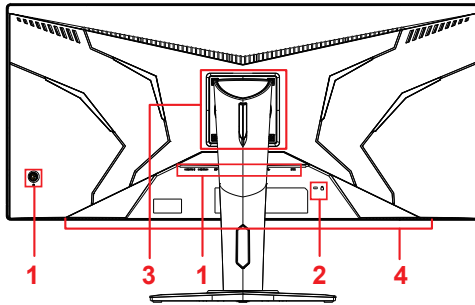

1. I/O port (input/output)

This area should include all I/O connection options, as well as the power input connector (Expanded in 2-4)

2. Kensington security slot

(Expanded in 2-3 section G)

3. VESA wall mounting

This area on the back of the monitor*. For the VESA wall mounting installation steps, please see 2-3 section F for additional instructions.

4. Speaker

2-3. Hardware Installation

A. Base Attachment Procedure

1

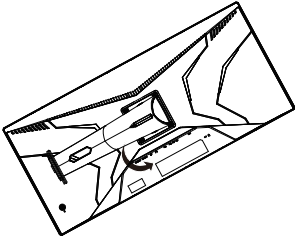

2

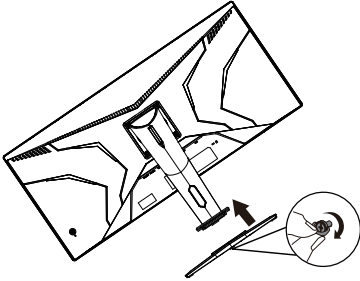

3

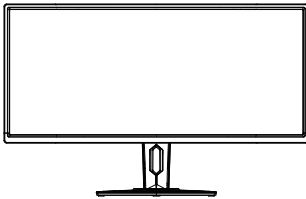

B. Base Removal Procedure

1

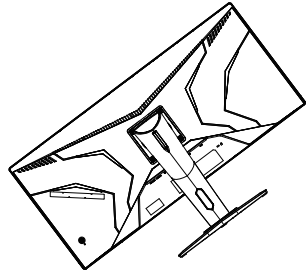

2

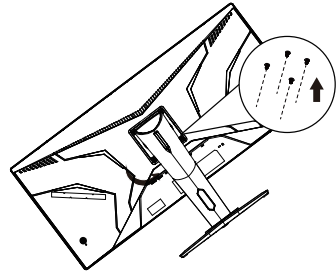

3

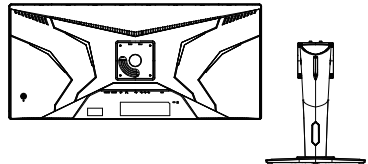

C. Adjusting the Monitor's Height

- Push the top of the monitor downward until it is at the desired viewing height for use.
- You can also pull the monitor back up, to the desired viewing height for use.

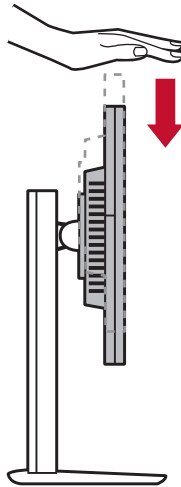

*This picture is for reference only

D. Adjusting the Angle

- After adjusting the monitor's height, stand in front of the monitor so it is centered in front of you.
- The angle of the screen can be adjusted by moving the panel, angling it forward or back for a flexible, comfortable viewing experience.

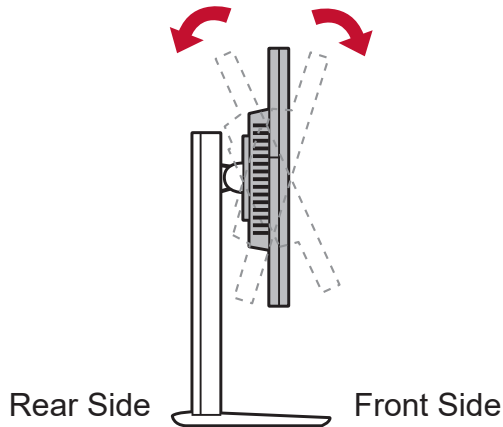

*This picture is for reference only

E. Pivot Feature

1. Lift/raise the monitor as high as it can go (max height).

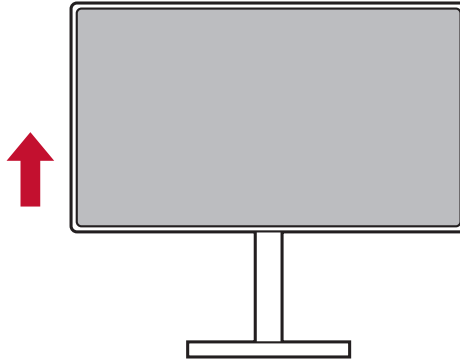

2. Adjust the monitor, angling the top back and pull the bottom forward (see the below picture for reference).

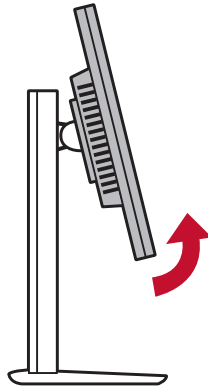

*This picture is for reference only

3. Rotate the monitor clockwise (see the below picture for reference).

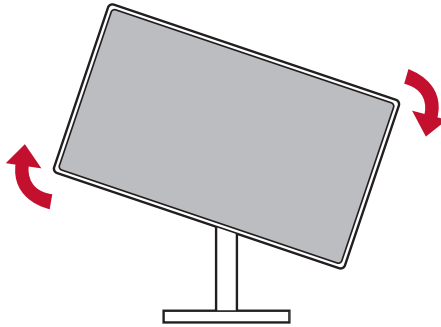

4. Finish the monitor installation by fully rotating the monitor 90°(see the below picture for reference).

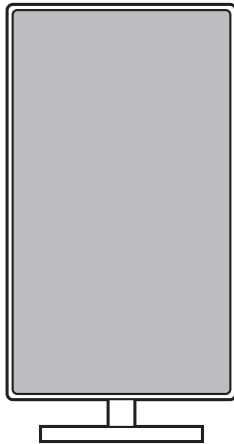

NOTE: XG350R-C 90° panel rotation is intended for packaging purposes only. The panel should not be rotated once it has been attached to the monitor base.

*This picture is for reference only

F. Wall Mounting (Optional)

NOTE: For use only with a UL Listed Wall Mount Bracket.

To obtain a wall-mounting kit or height adjustment base, contact ViewSonic® or your local dealer. Refer to the instructions that come with the base mounting kit. To convert your display from a desk-mounted to a wall-mounted display, do the following:

1. Find VESA compatible wall-mounting kit which meets the quaternions in section "Specifications".
2. Verify that the power button is turned Off, then disconnect the power cord.
3. Lay the display face down on a towel or blanket.
4. Remove the base. (Screws removal might be required.)
5. Attach the mounting bracket from the wall mounting kit using screws of the appropriate length.
6. Attach the display to the wall, following the instructions in the wall-mounting kit.

G. Using the Kensington Lock

The Kensington security connector is located on the back side of the monitor. For more information on installation and usage please visit the Kensington website at <http://www.kensington.com>.

Below is an example of setting up the Kensington lock on a table for your reference.

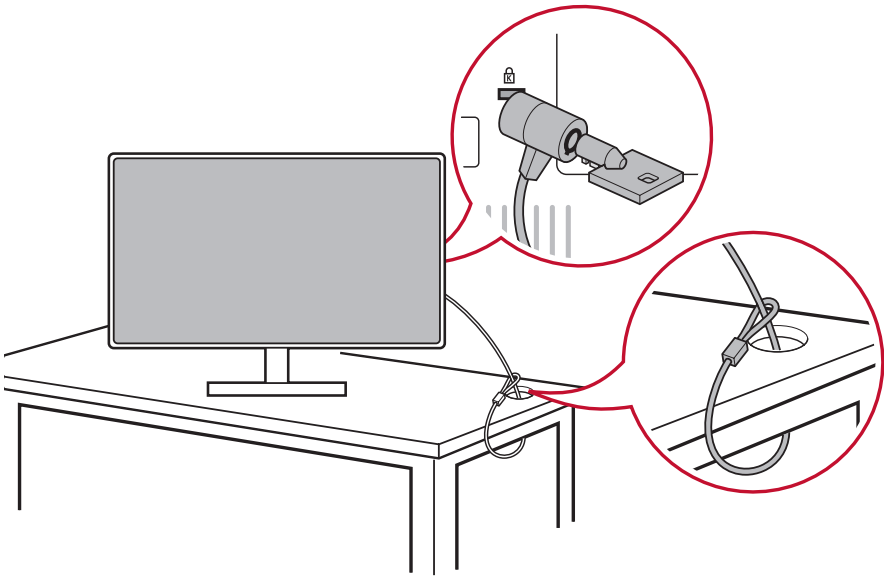

*This picture is for reference only

2-4. Quick Installation

Connect Signal Cables

1. Make sure both the LCD monitor and computer are turned OFF.
2. Remove rear panel covers if necessary.
3. Connect the signal cables from the LCD monitor to the computer.

3.A. Video and Audio Cable

For a MAC with Thunderbolt output, please connect the mini DP end of the “mini DP to DisplayPort cable” to the Thunderbolt output of MAC. And connect the other end of the cable to the DisplayPort connector on the rear of the monitor.

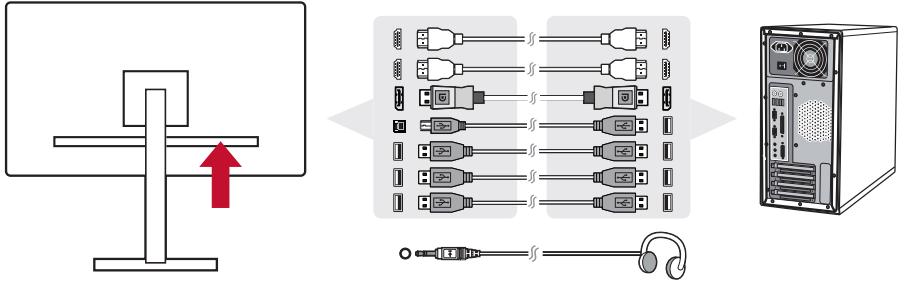

3.B. Power Cable (and AC/DC adapter if required)

Connect the female connector of AC power cord to the power connector of monitor, and the AC plug of AC power cord to the AC outlet.

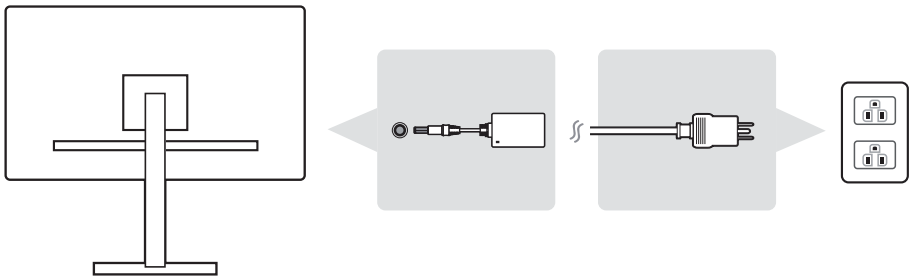

*This picture is for reference only

2-5. Power On

Turn On LCD Monitor and Computer

Turn ON the LCD Monitor, then turn ON the computer. This particular order (LCD monitor before computer) is important.

For DisplayPort MST daisy chain Setting

1. Input Source Auto detect function set to Off

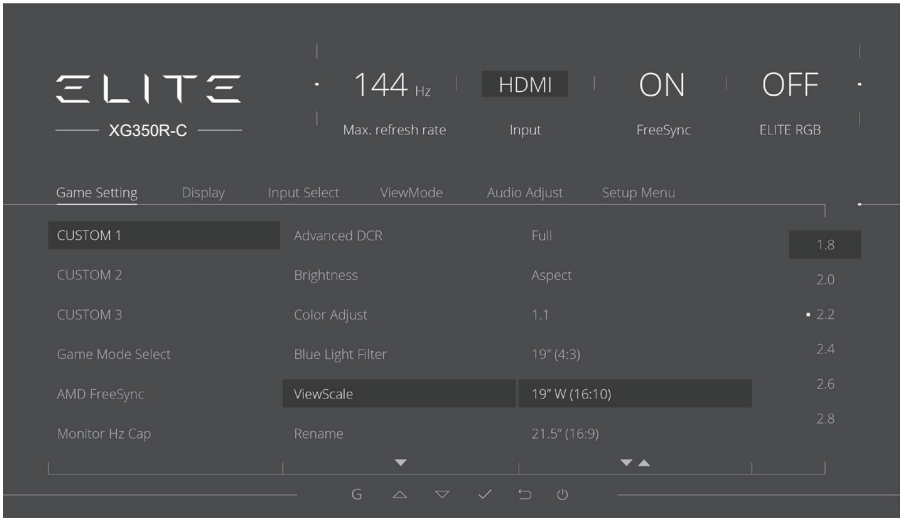

2. DisplayPort 1.1 mode set to On
*Highlight and select the DISPLAYPORT1.1 function

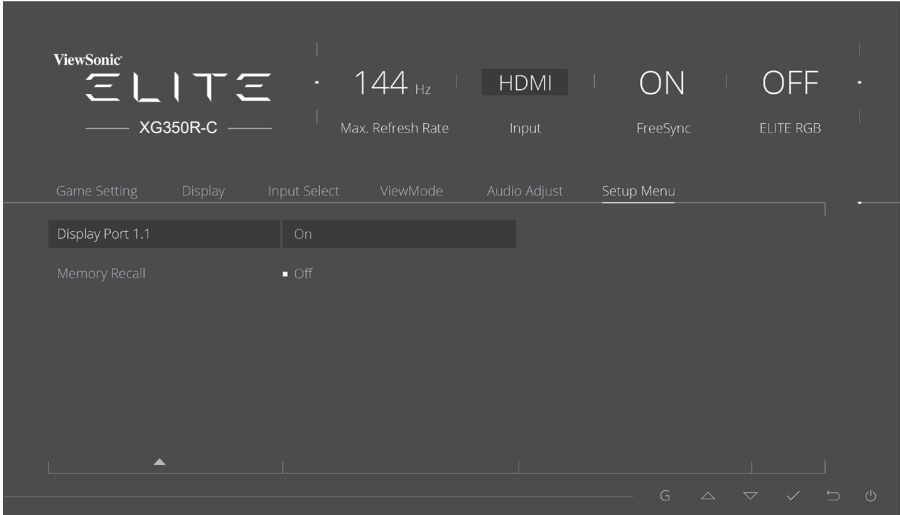

3. Enable MST mode from graphic card (if required)

2-6. Driver Installation (Windows 10 Setup)

In order to install the driver, first connect your monitor to your PC, boot up your PC (make sure to first turn on the monitor first) and make sure your internet is available. When the PC has finished booting up, your PC should auto- detect the monitor.

To ensure auto-detection is successful, go to 'Advanced Display Settings' under your system 'Display Settings' (screen resolution) window. There you can verify your ViewSonic monitor has been recognized by your PC in the 'Color Management' section of your advanced settings.

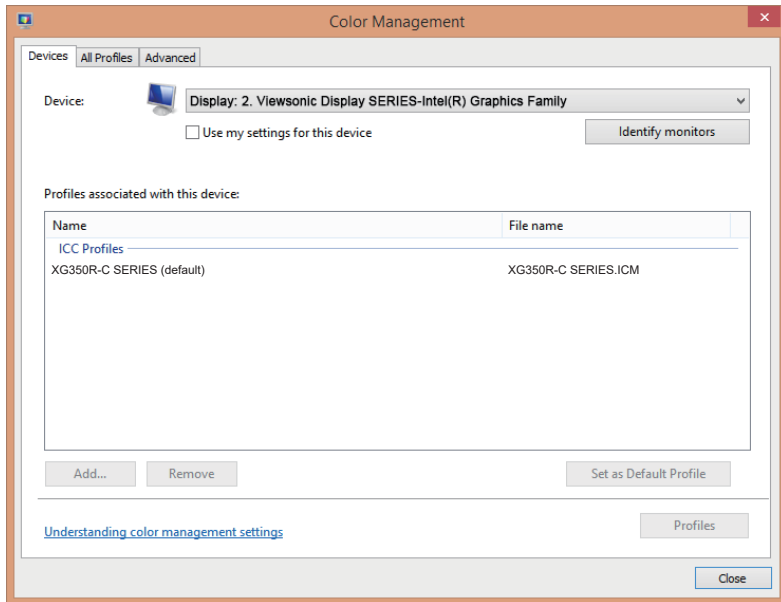

*This picture is for reference only

If your PC has not auto-detected the monitor, but is still functioning, you can download the driver from ViewSonic website and install it then restart your computer and follow the steps above again. It is not imperative for your computer to detect the monitor for normal use, but it is recommended.

If you encounter additional problems or have questions, please contact Customer Support.

3. Adjusting the Screen Image

3-1. Setting the Timing Mode

Set your monitor resolution to its recommended resolution (see section "specification") to get the best experience possible, with brilliant color and crisp text. Here is how:

1. Go to your display resolution settings window (each operating system will have a different process to get there).
2. Next, adjust the display resolution setting to match your monitor's native resolution. This will provide you with your best usage experience.

If you have difficulty setting the resolution or you do not see recommended resolution as an available option, you may need a newer video card driver. Contact your computer or video card manufacturer to obtain the latest driver.

- For D-Sub port, Please run Auto Image Adjust OSD to fine tune image quality.
If necessary, make small adjustments using H. POSITION and V. POSITION until the screen image is completely visible. (*for analog only). (The black border around the edge of the screen should barely touch the illuminated "active area" of the LCD monitor.)

3-2. Using the Control Panel



After setting the timing mode, use the buttons on the front or rear control panel to display and adjust OSD for screen image adjustment.



* The position refer to section 2.2

Bezel & OSD symbol explanation

The bezel symbol explanation is stated below:

	Standby Power On/Off
	NOTE: Power light Blue = ON Orange = Power Saving
	Game Mode icon that allows users to choose which Game mode setting they would like to activate for monitor use.

The OSD Menu and OSD Quick-Menu Symbol explanations and their functional uses are stated below.



Activation symbol to turn the various modes on when operating the menu system.



Activation symbol to exit, go back or deactivate the desired function that is selected.



Scrolls through menu options and adjusts the monitor controls.



Symbol used to go back or revert back to the previously selected menu



Information shortcut select button, which gives users access to the information of the monitor currently in use.



Main menu icon that allows users to access the main menu. Hold down the icon for a few seconds to turn off the main menu









Left and right icons toggle your selected choice horizontally.

The Quick-Menu symbol explanation is stated below:

NOTE: All OSD menus and adjustment screens disappear automatically after about 15 seconds. This is adjustable through the OSD timeout setting in the setup menu.

1. After pressing one of the squares, you will see options appear for quick access.

	
Game Mode	Exit

2. After the desired menu control is selected, use the     symbols to navigate and adjust the monitor to your specified preference.

Each menu function is explained in further detail in 4-2 OSD Explanation.

3. To save the adjustments and exit, press [**X**] until the OSD disappears.

4. OSD Menu Introduction

4-1. OSD Menu Tree

For an explanation of the OSD tree and pertaining functions, please refer to the 4-2 OSD explanation below. The OSD tree visually represents the complete OSD menu that can be accessed by your monitor. If you aren't sure where an option/function is or cannot locate a specific feature, please utilize the OSD tree below.

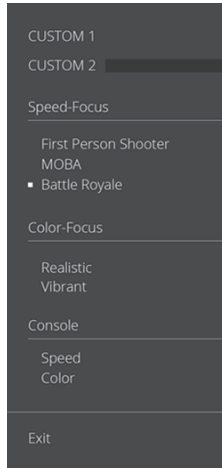

Startup Menu	
Speed-Focus	First Person Shooter
	MOBA
	Battle Royale
Color-Focus	Realistic
	Vibrant
Console	Speed
	Color
Custom 1	
Custom 2	
Exit	

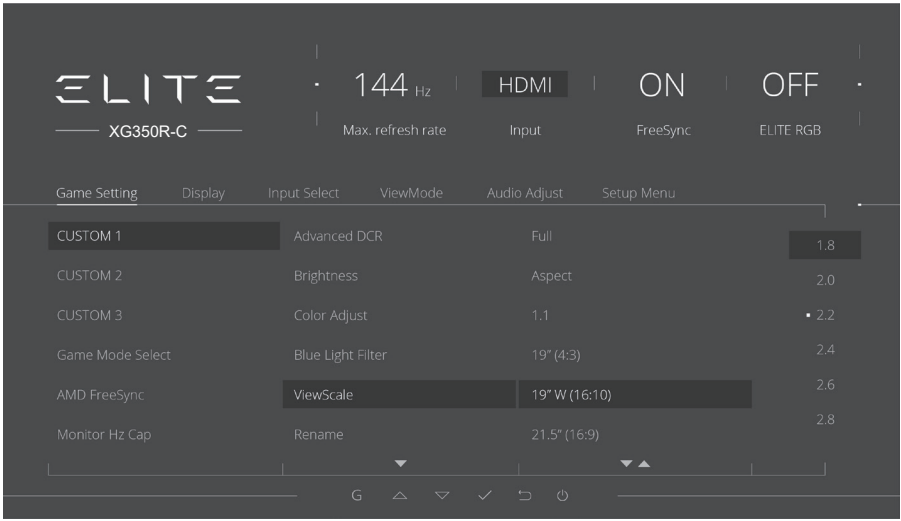

Menu

Gaming Settings	Custom 1	Response Time OD	Standard	
			Fast	
			Faster	
			Ultra Fast	
			Fastest	
			Explanation (i)	Response Time OD is a 5-level response time function for hardcore gamers.
		Hertz Limiter	Native (100Hz) / 60Hz	
		Black Stabilization	0~22/1	
		Advanced DCR	0~20/1	
		Brightness	0~100/1	
		Color Adjust	Contrast	0~100/1
			Color Saturation	0~100/1
			Gamma	1.8
				2.0
				2.2
2.4				
2.6				
2.8				
Blue Light Filter	0~100/1			

Menu

Gaming Settings	Custom 1	ViewScale	Full	
			Aspect	
			1:1	
			19" (4:3)	
			19"W (16:10)	Scale Adjust (0~100/10, default=0)
			21.5" (16:9)	
			22"W(16:10)	
			23.6"W (16:9)	
		24"W (16:9)		
		Rename		
	Reset			
	Custom 2	Response Time OD	Standard	
			Fast	
			Faster	
			Ultra Fast	
			Fastest	
			Explanation (i)	Response Time OD is a 5-level response time function for hardcore gamers.
		Hertz Limiter	Native (144Hz)	
			60Hz	
			100Hz	
		Black Stabilization	0~22/1	
		Advanced DCR	0~20/1	
		Brightness	0~100/1	
		Color Adjust	Contrast	0~100/1
			Color Saturation	0~100/1
			Gamma	1.8
				2.0
				2.2
2.4				
2.6				
2.8				

Menu

Gaming Settings	Custom 2	Blue Light Filter	(-/+ , 0~100)	
		ViewScale	Full	
			Aspect	
			1:1	
			19" (4:3)	
			19"W (16:10)	Scale Adjust
			21.5" (16:9)	(0~100/10, default=0)
			22"W(16:10)	
		23.6"W (16:9)		
		24"W (16:9)		
	Rename			
	Reset			
	Game Mode Select	Speed-Focus	Optimized	
			First Person Shooter	
			MOBA	
			Battle Royale	
		Color-Focus	Optimized	
			Realistic	
			Vibrant	
		Console	Speed	
Color				
Custom 1				
Custom 2				

Menu				
Gaming Settings	AMD FreeSync	On		
		Off		
	ClearMotion	On/Off		
	Hertz Limiter	Native(100Hz)/60Hz		
Display	Color Temperature	SRGB		
		Bluish		
		Cool		
		Native		
		Warm		
		Full Color Control	Red	(0~100/1, Default=100)
		Green		
		Blue		
	Color Adjust	Color Space	Auto	
			RGB	
			YUV	
		Color Range	Auto	
			Full Range	
		Gamma	Limited Range	
			1.8	
2				
2.2				
2.4				
	2.6			
	2.8			
Color Saturation	(-/+ , 0~100)			
Black Stabilization	(-/+ , 0~22)			

Menu

Display	Image Adjust	ViewScale	Full	
			Aspect	
			1 to 1 (1:1)	
			19" (4:3)	
			19"W (16:10)	Scale Adjust (0~100/10, default=0)
			21.5" (16:9)	
			22"W(16:10)	
			23.6"W (16:9)	
		24"W (16:9)		
		Contrast	0~100/1	
		Brightness	0~100/1	
		Response Time OD	Standard/Fast/ Faster/Ultra Fast/ Fastest	
			Explanation (i)	Response Time OD is a 5-level response time function for hardcore gamers.
	Sharpness	0~100/1		
Overscan	On			
	Off			
Blue Light Filter	0~100/1			
	HDR10	Auto/Off		
Input Select	HDMI 1			
	HDMI 2			
	DisplayPort			
ViewMode	Standard			
	Movie			
	Web			
	Text			
	MAC			
	Mono			
Audio Adjust	Volume	(-/+ , 0~100)		
	Mute	On		
		Off		
	Audio Output	HDMI1		
		HDMI2		
		DisplayPort		
Sonic Mode	Standard/Live/ Suuround			

Menu

Setup Menu	Language Select	English		
		Français		
		Deutsch		
		Español		
		Italiano		
		Suomi		
		Русский		
		Türkçe		
		日本語		
		한국어		
		繁體中文		
		简体中文		
		Čeština		
	Svenska			
	Information	Resolution/H/V/Pixel Clock /Model Number /SN/www.ViewSonic.com		
	Resolution Notice	On		
		Off		
	Boot Up Screen	On		
		Off		
	OSD Pivot	On		
		Off		
	OSD Timeout	(-/+, 5/15/30/60)		
	OSD Background	On		
		Off		
	Power Indicator	On		
		Off		
	PSL	On		
Off				
Auto Power Off	On			
	Off			
Sleep	30 Minutes			
	45 Minutes			
	60 Minutes			
	120 Minutes			
	Off			

Menu

Setup Menu	ECO Mode	Standard		
		Optimize		
		Conserve		
	DDC/CI	On		
		Off		
	Multi-Picture	Off		
		PBP Left-Right	Left Source Select	HDMI1/HDMI2/DisplayPort
			Right Source Select	HDMI1/HDMI2/DisplayPort
			Swap	
		PIP	PIP Source Select	HDMI1/HDMI2/DisplayPort
			PIP H. Position	(0~100/1, default = 0)
			PIP V. Position	(0~100/1, default = 0)
			PIP Size	(33/66/100) (H, V) 35%, 40%, 45%
			PIP Swap	
		DisplayPort1.1	Off / On (DisplayPort1.2/DisplayPort1.1)	
		Elite RGB	On	
			Off	
			Reset	
		Standby Charger	Off / On	
		Memory Recall		

4-2. OSD Menu Explanation

NOTE: The OSD menu items listed in this section indicate the entire OSD items of all models. Some of these items may not exist in your product OSD. Please disregard OSD menu item explanations if they do not exist in your OSD Menu. Please refer to the 4-1 OSD Tree (above), for your monitor's available OSD menu items. Please refer to the OSD explanation below (in alphabetical order), for a clearer explanation of what each function does.

A Audio adjust

Adjusts the volume, mutes the sound, or toggles between inputs if you have more than one source.

Auto image adjust

Automatically sizes, centers, and fine tunes the video signal to eliminate waviness and distortion.

NOTE: Auto Image Adjust works with most common video cards. If this function does not work on your LCD display, then lower the video refresh rate to 60 Hz and set the resolution to its pre-set value.

Advanced DCR

Advanced DCR technology automatically detects the image signal and intelligently controls the backlight brightness and color, to improve on the ability to make the black blacker in a dark scene, and make the white whiter in a bright environment.

Auto Detect

If current input source is no signal, monitor will automatically switch to next input option. This function on some model is disabled by default.

A AMD FreeSync

Using the AMD FreeSync™ technology puts an end to choppy gameplay and broken frames with fluid, artifact-free performance at virtually any framerate. To utilize FreeSync, ensure that the monitor and GPU FreeSync options are activated (*the default setting is off for the monitor)

The steps to enable your FreeSync monitor are below:

1. Make sure you have a FreeSync™-enabled AMD product from the AMD website installed on your computer and download the free FreeSync™ driver for your particular product.
2. Activate FreeSync in your GPU via your PC.
3. Activate FreeSync in your FreeSync™-enabled monitor.

NOTE:

1. It would usually not work under still image & reliability test conditions. Under those conditions, the phenomenon such as image sticker and flicker could occur on the screen.

*Each FreeSync monitor range varies, depending on model. Please refer to the monitor's specifications (section 5), for your monitor's range.

B Black stabilization

ViewSonic's Black stabilization provides heightened visibility and detail by brightening dark scenes with a new advanced 0-22 step range.

Blue light filter

Adjusts the filter that blocks high-energy blue light for a safer experience for our users.

Boot Up Screen

Turning the boot screen off will disable the onscreen message from displaying when turning on the monitor.

Brightness

Adjusts background black levels of the screen image.

C

Color adjust

Provides several color adjustment modes, to help adjust the color settings to fit our users' needs.

ColorX

Adjusts the color range, allowing users to adjust the range in RGB and YUV color settings.

Color space

Allows users to choose which color space they would like to use for monitor color output (RGB, YUV).

Color temperature

Allows users to select specific color temperature settings to further customize their viewing experience.

Explanation	
sRGB	Standard color space used for the windows system, digital cameras and the Internet.
EBU	EBU color space used for NTSC/EBU (PAL, SECAM) TV Domain
NATIVE	Native is a default color temperature. Recommended for general graphic design and regular use.

Console

Adjusts the difference between the image background (black level) and the foreground (white level).

Color adjustment functions

To deliver precise and accurate color performance, the independent color adjustment functions (red, green, blue, cyan, magenta and yellow) allows users to customize hue and saturation for each color axis individually, without affecting the other color outputs.

C Color Saturation

Adjusts the color depth of each color (red, green, blue, cyan, magenta and yellow)

Custom 1/2

Providing even more support, three customizable "Custom" settings are available to help match individual preferences and adapt to every type of game on the market. Select one of the 'Custom' options (Custom 1/2) in the Menu and adjust the advanced options. After exiting the setting will automatically be saved under that particular "Custom" setting or rename the setting to your liking by selecting "Rename". You can access your saved 'GAME MODE' settings with the Gaming Hotkey as well.

ClearMotion™

When activated, ClearMotion™ reduces blur, ghosting, and smearing from fast moving objects. The backlight strobing technology is tuned to produce clear visuals, drastically improving left to right motion image clarity.

*Specifications may vary depending upon model/region. Brightness level may reduce for higher response time when ClearMotion™ is turned on.

D Display

A submenu that allows users to adjust color and image adjust menus in the display.

E Explanation

Gives a brief explanation of new tech functions/features in the monitor OSD.

E ELITE RGB

This setting controls the RGB lighting on the back of the monitor in order to enhance your RGB experience. When switched on, or after being reset, the default 'Rainbow Wave' will activate. In addition, the RGB backlights are also synced with several key partners. Downloading their software will give you the power to manipulate your RGB capabilities even further. If you would like to leverage partnered software see the advanced setup below.

Partner Software RGB Setup

1. Visit gaming.viewsonic.com and choose a partner RGB software to download.
2. Download and install your software of choice.
3. Included with your monitor is a USB 3.0 A-Male to B-Male cable. Plug in the USB 3.0 B-Male connector to your monitor and the USB 3.0 A-Male connector to your PC.
4. Run the partner software and start customizing your RGB lighting!

You can also check out our RGB software setup tutorials online at gaming.viewsonic.com.

*Mode variations, customization features and any other features or uses shall be based on and subject to the terms of use, end user license agreement and the software capabilities as specified or provided in partners' software.

F Fine tune

Adjusts the tuning for analog signals.

Fast/Faster/Fastest/Ultra Fast

Different levels of response time adjustment for custom gaming modes.

F Full

An aspect ratio setting which scales the input image to fill the screen.

Full Color Control

A setting to adjust RGB colors for specific gaming uses. Can be adjusted in Gaming Settings→ Custom1/2 mode or in the Display submenu.

G Gaming Hotkey

A quick-access menu for gamers to select their preferred color settings, giving gamers the ability to adapt to each gaming scenario.

Game Mode Select

A sub-menu where users can select game modes outside of the gaming hotkey menu.

Gaming Lite

A gaming mode ViewSonic developed to optimize gameplay for non-competitive games, to reduce monitor loading and power, to improve long-term performance.

Gaming Settings

Integrating a gaming-oriented OSD design including pre-calibrated FPS, RTS and MOBA gaming settings, each mode is functionally customized with in-game testing and adjustments made for the best blend of color and technology. To access the game mode first open the Main Menu setting, then go to 'ViewMode', select 'Game' and change your 'GAMER' settings from there.

GAMMA

Allows users to manually adjust the brightness level of the monitor's grayscale levels. There are five selections: 1.8, 2.0, 2.2, 2.4, and 2.6.

H HUE

Adjusts the hue of each color (red, green, blue, cyan, magenta and yellow).

H HDR (High Dynamic Range)

HDR (High Dynamic Range) is a display technology that increases the amount of visible detail in both the brighter and darker parts of a scene, when compared to SDR (Standard Dynamic Range). XG350R-C is HDR compatible and has the ability to decode HDR content.*

*In order to display High Dynamic Range on XG350R-C, content being viewed must be optimized for HDR

I Image Adjust

Displays the Image Adjust menu. You can manually set a variety of image quality adjustments. (deleted Manual Image Adjust)

Information

Displays the timing mode (video signal input) coming from the graphics card in the computer, the LCD model number, the serial number, and the ViewSonic® website URL. See your graphics card's user guide for instructions on changing the resolution and refresh rate (vertical frequency).

NOTE: VESA 1024 x 768 @ 60Hz (example) means that the resolution is 1024 x 768 and the refresh rate is 60 Hertz.

Input select

Toggles between the various input options that are available for that particular monitor.

M Memory recall

Returns the adjustments back to factory settings if the display is operating in a factory Preset Timing Mode listed in the Specifications of this manual.

Exception: This control does not affect changes made with the Language Select or Power Lock setting

Hertz Limiter

A monitor hertz controller that allows users to control how many frames the monitor can output. The monitor will put a cap on the maximum amount of frames that can be rendered from the monitor to save power and loading from the monitor side; it is meant to reduce monitor loading and power consumption

O Overscan

Can be used to adjust the aspect ratio of the input signal received by your monitor to adjust the image so it appears on the monitor.

OFFSET

Adjusts black levels for red, green and blue.

The gain and offset functions allow users to control the white balance for the upmost control when manipulating contrast and dark scenes.

OSD Pivot

Set monitor OSD screen display direction.

Options	Explanation
Auto	With built-in G sensor, the OSD can auto pivot when positioned vertically.
0°	Set the OSD screen without pivot
+90°	Set the OSD screen +90° pivot
-90°	Set the OSD screen -90° pivot
180°	Set the OSD screen 180° pivot

P PIP Swap

Press PIP Swap to change the image source of the smaller screen with the larger screen when the PIP function is selected

To deactivate any “multi-picture” mode, simply go to the “multi-picture” option and select the same mode again to reset your monitor back to normal.

Power Indicator

The power indicator is the light that displays whether the monitor is on or off and this setting controls the lighting on the stand. Users can turn off the light effect under power indicator, and choose “off”. The power indicator displays an average color directly interpreting the input color signal received on screen, displaying an average color, based on what is being displayed on the monitor. For reference, if the monitor is displaying more green, the LED will become greener. Users can also change the monitor. Users can also directly change red/green/blue color values under the OSD, to directly choose the color being displayed.

R Response time OD

An advanced tuning function for users that want to adjust their monitor’s response time. They can select from 5 different levels to more precisely tune the response to be as fast as needed while reducing blurring or ghosting based on each unique gaming scenario.

Resolution notice

The notice tells users that the current viewing resolution is not the correct native resolution. This notice will appear in the display settings window, when setting up the display resolution.

Recall

Resets the Veivmode monitor settings.

Reset

Resets the Custom gaming mode settings to their default values.

S Setup menu

Adjusts On-screen Display (OSD) settings. Many of these settings can activate on-screen display notifications so users do not have to reopen the menu.

Scale Adjust

Within the “ViewScale” adjustment menu, some screen sizes can be further adjusted with Scale Adjust. This allows users to manually adjust the chosen aspect ratio without distorting the outputted image.

Sharpness

Adjusts the sharpness and picture quality of the monitor.

Save as

The OSD save function is located in the main menu. There are 3 main positions (USER MODE 1, USER MODE 2, USER MODE3), which allows users to save their OSD settings.

Sonic mode

• Standard

A specially engineered audio mode tuned for optimal sound output for daily entertainment and computing needs.

• Live

Live mode has been engineered for ideal gaming by stabilizing high-frequency noises. The sources of sound are individually tweaked to equalize bass and treble for a balanced audio response that will best suit users' needs.

• Surround

Turn on Surround mode for a more immersive sound experience. This mode uses virtual surround sound techniques that mimic the effect of a multi-speaker surround-sound system, thus creating the perception that there are many more sources of sound than are actually present.

V **ViewMode**

ViewSonic's unique ViewMode feature offers "Game," "Movie," "Web," "Text," and "Mono" presets. These presets are specifically designed to deliver an optimized viewing experience for different screen applications.

ViewScale

Gamers have the ability to adjust the display size of the image on the monitor, allowing for a "best fit" scenario.

4-3. Advanced Settings for Gamers

These settings have been explained in the OSD menu section above. Their functional use and instructions on setup are below.

1. Rampage Response

Step 1: Activate your OSD

Step 2: Select the “Gaming Settings” menu

Step 3: Select the “Custom 1/2”

Under Custom 1/2, you can adjust the rampage response setting to fine-tune your response time. With 5 settings to choose from, gamers can precisely select the best fit for each scenario. Each setting will increase response time speed, allowing gamers the ability to match their PC and game type, creating a “best fit” scenario.

1 Standard
2 Fast
3 Faster
4 Ultra Fast
5 Fastest

2. Black Stabilization

Step 1: Activate your OSD

Step 2: Select the “Gaming Settings” menu

Step 3: Select the “Custom 1/2” menu

Step 4: Select “Black Stabilization”

*(you can also find the setting by going to “Display” → “Color Adjust” → “Black Stabilization”)

Black Stabilization allows users to adjust the level of black displayed to create better viewing scenarios for games and media content. You can adjust the black level by using the arrow buttons and selecting a number value from 1-22. It will expand the dark shade range without impacting lighter images.

3. AMD FreeSync

Step 1: Activate your OSD

Step 2: Select the “Manual Image Adjust” menu

Step 3: Select the “Advanced Image Adjust” menu

Step 4: Select “AMD FreeSync”

Selecting AMD FreeSync in the Advanced Image Adjust menu will activate the function via your monitor ONLY (To make sure FreeSync is on, check your graphics card settings).

4. Hertz Limiter

Step 1: Activate your OSD

Step 2: Select the “Gaming Settings” menu

Step 3: Select the “Custom 1/2”

Under Custom 1/2, you can adjust the Monitor Hertz Cap setting to fine-tune your response time. With 5 settings to choose from, gamers can precisely match the best fit for each scenario. Each setting will cap the outputted Hz of the monitor, allowing gamers the ability to match their PC and game type, creating a “best fit” scenario. If your GPU cannot reach 144Hz yet, users can save power and loading on their monitor by reducing their hertz output.

*Note

1. FreeSync can only be used at native 144Hz
2. ViewScale may not support all Hz levels

Native (100Hz)
60Hz
100Hz

5. ViewScale

Step 1: Activate your OSD

Step 2: Select the “Gaming Settings” menu

Step 3: Select the “Custom 1/2” menu

Step 4: Select “ViewScale”

Under ViewScale, users can adjust their current aspect ratio to fit their specific usage scenario. Below are the listed aspect ratios. If users choose a ViewScale aspect mode that is not native, it may impact the user’s experience.

Full	Scales the inputted image to fill the screen, this is the default input choice and is ideal for 16:9 images.
Aspect	The inputted image is allowed to fill the screen as large as it can go without image distortion.
1 to 1 (1:1)	The image is directly displayed without scaling.
19" (4:3)	Simulates the inputted image in a 4:3 aspect ratio and 19" display size.
19"W (16:10)	Simulates the inputted image in a 16:10 aspect ratio and 19"W" display size.
21.5" (16:9)	Simulates the inputted image in a 16:9 aspect ratio and 21.5" display size.
22"W(16:10)	Simulates the inputted image in a 16:10 aspect ratio and 22"W display size.
23.6"W (16:9)	Simulates the inputted image in a 16:9 aspect ratio and 23.6"W display size.
24"W (16:9)	Simulates the inputted image in a 16:9 aspect ratio and 24"W display size.

4-4. Monitor Setting Management

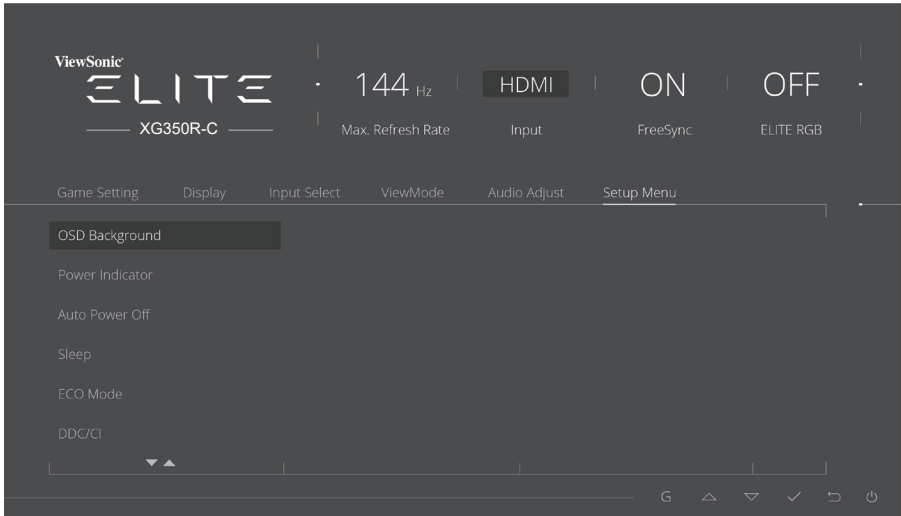

OSD Timeout

The OSD Timeout function, allows users to choose how long the OSD will reside on the screen after in-activity (number of seconds).

OSD Background

The OSD Background function allows users to turn off the OSD background while selecting and adjusting OSD settings.

Power Indicator

The power indicator is the light that displays whether the monitor is on or off.

Auto Power Off

Selecting Auto Power Off, allows the monitor to shut its power off after a certain amount of time.

Sleep

This setting allows users to adjust the time of inactivity before the monitor goes on a reduced power mode. The screen will be on 'sleep mode' during this time.

Eco Mode

Allows users to choose between various modes, based on power consumption.

DDC/CI (Display Data Channel Command Interface)

Activating this setting allows monitor control via the graphics card.

Boot Screen On/Off

Turning the boot screen off will disable the onscreen message from displaying when turning on the monitor.

5. Specifications

LCD	Type	TFT (Thin Film Transistor), Active Matrix 3440 x 1440 LCD, 0.2382 mm x 0.2402 mm pixel pitch
	Display Size	Metric: 88.981 cm Imperial: 35" (35" viewable)
	Color Filter	RGB vertical stripe
	Glass Surface	Anti-Glare

Input Signal	Video Sync	HDMI (v2.0) (Timing Max limited support 3440 x 1440 @144Hz) TMDS digital (100ohms) f_h :15-160 kHz, f_v :48-100 Hz DisplayPort (v1.4) (Timing Max support 3440 x 1440 @100Hz) PCI-E f_h :15-160 kHz, f_v :48-100 Hz
---------------------	------------	--

Compatibility	PC	Up to 3440 x 1440 Non-interlaced
	Macintosh ¹	Power Macintosh up to 3440 x 1440 (Supported by limited graphic cards)

Resolution²	Recommended	3440 x 1440 @60Hz												
	Supported	3440 x 1440 @60Hz, 100Hz 1920 x 1080 @ 144 Hz, 120Hz, 100Hz 1680 x 1050 @ 60 Hz 1440 x 900 @ 60 Hz 1280 x 1024 @ 60, 75 Hz 1024 x 768 @ 60, 70, 75 Hz 800 x 600 @ 56, 60, 72, 75 Hz 640 x 480 @ 60, 72, 75 Hz 720 x 400 @ 70 Hz												
Power Adaptor³	Input Voltage	100-240 VAC, 50/60 Hz (auto switch)												
Display area	Full Scan	819.408 mm (H) x 345.888 mm (V) 32.26" (H) x 13.62" (V)												
Operating conditions	Temperature	+32 °F to +104 °F (0 °C to +40 °C)												
	Humidity	10% to 90% (non-condensing)												
	Altitude	To 10,000 feet												
Storage conditions	Temperature	-4 °F to +140 °F (-20 °C to +60 °C)												
	Humidity	5% to 90% (non-condensing)												
	Altitude	To 40,000 feet												
Dimensions	Physical	847.9 mm (W) x 434.6~534.6 mm (H) x 306.0 mm (D) 33.38" (W) x 17.11~21.05" (H) x 12.05" (D)												
Wall Mount	<table border="1"> <thead> <tr> <th>Max Loading</th> <th>Hole pattern (W x H; mm)</th> <th>Interface Pad (W x H x D)</th> <th>Pad Hole</th> <th>Screw Q'ty & Specification</th> </tr> </thead> <tbody> <tr> <td>14kg</td> <td>100mm x 100mm</td> <td>115 mm x 115 mm x 2.6 mm</td> <td>Ø 5mm</td> <td>4 piece M4 x 10mm</td> </tr> </tbody> </table>				Max Loading	Hole pattern (W x H; mm)	Interface Pad (W x H x D)	Pad Hole	Screw Q'ty & Specification	14kg	100mm x 100mm	115 mm x 115 mm x 2.6 mm	Ø 5mm	4 piece M4 x 10mm
	Max Loading	Hole pattern (W x H; mm)	Interface Pad (W x H x D)	Pad Hole	Screw Q'ty & Specification									
14kg	100mm x 100mm	115 mm x 115 mm x 2.6 mm	Ø 5mm	4 piece M4 x 10mm										
Weight	Physical	29.76 lb (13.5 kg)												

Power saving modes	On ⁴	70W (typ) w/o usb & backcover LED light
	Off	<0.3W

- ¹ Do not set the graphics card in your computer to exceed these timing mode; doing so may result in permanent damage to the display.
- ² Please use the power adaptor from ViewSonic® or authorized source only.
- ³ The test condition follows EEI standard

6. Troubleshooting

No power

- Make sure the power button (or switch) is ON.
- Make sure the A/C power cord is securely connected to the display.
- Plug another electrical device (like a radio) into the power outlet to verify that the outlet is supplying proper voltage.

Power is ON but no screen image

- Make sure the video cable supplied with the display is properly secured to the video output port on the back of the computer. If the other end of the video cable is not attached permanently to the display, properly secure it to the display.
- Adjust brightness and contrast.
- If you are using an Macintosh older than G3, you need a Macintosh adapt

Wrong or abnormal colors

- If any colors (red, green, or blue) are missing, check the video cable to make sure it is securely connected. Loose or broken pins in the cable connector could cause an improper connection.
- Connect the display to another computer.
- If you have an older graphics card, contact ViewSonic® for a non-DDC adapter.

Control buttons do not work

- Press only one button at a time.

7. Cleaning and Maintenance

Safe Cleaning Practices

- Make sure the display is turned off.
- Never spray or pour any liquid directly onto the screen or case.

To clean the screen:

1. Wipe the screen with a clean, soft, lint-free cloth. This removes dust and other particles.
2. If the screen is still not clean, apply a small amount of non-ammonia, non-alcohol based glass cleaner onto a clean, soft, lint-free cloth, and wipe the screen.

To clean the case:

1. Use a soft, dry cloth.
2. If the case is still not clean, apply a small amount of a non-ammonia, non-alcohol based, mild non-abrasive detergent onto a clean, soft, lint-free cloth, then wipe the surface.

Disclaimer

- ViewSonic® does not recommend the use of any ammonia or alcohol-based cleaners on the display screen or case. Some chemical cleaners have been reported to damage the screen and/or case of the display.
- ViewSonic will not be liable for damage resulting from use of any ammonia or alcoholbased cleaners.

Caution:

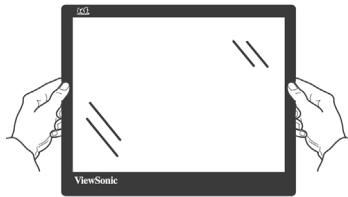

Handle the monitor on the edges only.

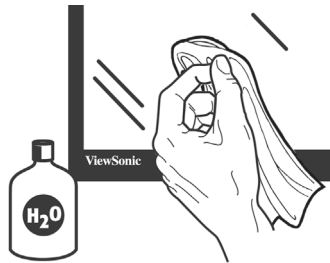

Clean with water on a soft cotton cloth only.

8. Compliance Information

NOTE: This section addresses all connected requirements and statements regarding regulations. Confirmed corresponding applications shall refer to nameplate labels and relevant markings on unit.

8-1. FCC Compliance Statement

This device complies with part 15 of FCC Rules. Operation is subject to the following two conditions: (1) this device may not cause harmful interference, and (2) this device must accept any interference received, including interference that may cause undesired operation.

This equipment has been tested and found to comply with the limits for a Class B digital device, pursuant to part 15 of the FCC Rules. These limits are designed to provide reasonable protection against harmful interference in a residential installation. This equipment generates, uses, and can radiate radio frequency energy, and if not installed and used in accordance with the instructions, may cause harmful interference to radio communications. However, there is no guarantee that interference will not occur in a particular installation. If this equipment does cause harmful interference to radio or television reception, which can be determined by turning the equipment off and on, the user is encouraged to try to correct the interference by one or more of the following measures:

- Reorient or relocate the receiving antenna.
- Increase the separation between the equipment and receiver.
- Connect the equipment into an outlet on a circuit different from that to which the receiver is connected.
- Consult the dealer or an experienced radio/TV technician for help.

Warning: You are cautioned that changes or modifications not expressly approved by the party responsible for compliance could void your authority to operate the equipment.

8-2. Industry Canada Statement

CAN ICES-3 (B)/NMB-3(B)

8-3. Declaration of RoHS2 Compliance

This product has been designed and manufactured in compliance with Directive 2011/65/EU of the European Parliament and the Council on restriction of the use of certain hazardous substances in electrical and electronic equipment (RoHS2 Directive) and is deemed to comply with the maximum concentration values issued by the European Technical Adaptation Committee (TAC) as shown below:

Substance	Proposed Maximum Concentration	Actual Concentration
Lead (Pb)	0.1%	< 0.1%
Mercury (Hg)	0.1%	< 0.1%
Cadmium (Cd)	0.01%	< 0.01%
Hexavalent Chromium (Cr ⁶⁺)	0.1%	< 0.1%
Polybrominated biphenyls (PBB)	0.1%	< 0.1%
Polybrominated diphenyl ethers (PBDE)	0.1%	< 0.1%

Certain components of products as stated above are exempted under the Annex III of the RoHS2 Directives as noted below:

Examples of exempted components are:

1. Lead in glass of cathode ray tubes.
2. Lead in glass of cathode ray tubes.
3. Lead in glass of fluorescent tubes not exceeding 0.2% by weight.
4. Lead as an alloying element in aluminium containing up to 0.4% lead by weight.
5. Copper alloy containing up to 4% lead by weight.
6. Lead in high melting temperature type solders (i.e. lead-based alloys containing 85% by weight or more lead).
7. Electrical and electronic components containing lead in a glass or ceramic other than dielectric ceramic in capacitors, e.g. piezo-electronic devices, or in a glass or ceramic matrix compound.

8-4. Indian Restriction of Hazardous Substances

Restriction on Hazardous Substances statement (India) This product complies with the “India E-waste Rule 2011” and prohibits use of lead, mercury, hexavalent chromium, polybrominated biphenyls or polybrominated diphenyl ethers in concentrations exceeding 0.1 weight % and 0.01 weight % for cadmium, except for the exemptions set in Schedule 2 of the Rule.

8-5. Product Disposal at End of Product Life

ViewSonic respects the environment and is committed to working and living green. Thank you for being part of Smarter, Greener Computing.

Please visit ViewSonic website to learn more.

USA & Canada:

<http://www.viewsoniceurope.com/eu/support/call-desk/>

Europe: <http://www.viewsoniceurope.com/eu/support/call-desk/>

Taiwan: <http://recycle.epa.gov.tw/>

9. Copyright Information

Copyright ©ViewSonic® Corporation, 2018. All rights reserved.

Macintosh and Power Macintosh are registered trademarks of Apple Inc.

Microsoft, Windows, and the Windows logo are registered trademarks of Microsoft Corporation in the United States and other countries.

ViewSonic, the three birds logo, OnView, ViewMatch, and ViewMeter are registered trademarks of ViewSonic Corporation.

VESA is a registered trademark of the Video Electronics Standards Association. DPMS, DisplayPort, and DDC are trademarks of VESA.

ENERGY STAR® is a registered trademark of the U.S. Environmental Protection Agency (EPA).

As an ENERGY STAR® partner, ViewSonic Corporation has determined that this product meets the ENERGY STAR® guidelines for energy efficiency.

Disclaimer: ViewSonic Corporation shall not be liable for technical or editorial errors or omissions contained herein; nor for incidental or consequential damages resulting from furnishing this material, or the performance or use of this product.

In the interest of continuing product improvement, ViewSonic Corporation reserves the right to change product specifications without notice. Information in this document may change without notice.

No part of this document may be copied, reproduced, or transmitted by any means, for any purpose without prior written permission from ViewSonic Corporation.

10. Service Information

Product Registration

Thank you for purchasing a ViewSonic product! Registering activates your product's standard Limited Warranty and entitles you to receive new product updates and information if desired.

Please complete this form to register your new product, then mail/fax to ViewSonic using the information provided on the following page. Items marked with an asterisk (*) are required.

First Name* (given name) _____

Last Name* (family name) _____

Email Address* _____

Street Address* (line 1) _____

Street Address* (line 2) _____

City/Country* _____ State/Province* _____

Zip code/Postal code* _____ Country* _____

Phone Number* _____ Date Purchased* _____

Product Type* _____ Model Number* _____

Serial Number* _____

Operating System _____

YES NO | Check "YES" to receive email communication from ViewSonic, including exclusive promotional offers.

At ViewSonic we respect your privacy. ViewSonic does not sell its customer lists or similar information to third parties.

*Product registration available in selected countries only



Customer Service

For technical support or product service, see the table below or contact your reseller.

NOTE: You will need the product serial number.

Asia pacific			
Country/ Region	Website	T= Telephone C = CHAT ONLINE	Email
ViewSonic Corporation	http://www.viewsonic.com.tw/	T= 886 2 2246 3456 F= 886 2 2249 1751 Toll Free= 0800-899880	service@tw.viewsonic.com
China	www.viewsonic.com.cn	T= 4008 988 588	service.cn@cn.viewsonic.com
Hong Kong	www.hk.viewsonic.com	T= 852 3102 2900	service@hk.viewsonic.com
Macau	www.hk.viewsonic.com	T= 853 2833 8407	service@hk.viewsonic.com
Japan	www.viewsonicjapan.co.jp	service@jp.viewsonic.com	
Korea	ap.viewsonic.com/kr/	T= 080 333 2131	service@kr.viewsonic.com
India	www.in.viewsonic.com	T= 1800 419 0959	service@in.viewsonic.com
Singapore/ Malaysia/ Thailand	www.ap.viewsonic.com	T= 65 6461 6044	service@sg.viewsonic.com
Europe			
Europe	www.viewsoniceurope.com	http://www.viewsoniceurope.com/eu/support/call-desk/	
Arabia	ap.viewsonic.com/me/	اتصل بالبايع المحلي	
България	www.viewsoinceurope.com	http://www.viewsoniceurope.com/eu/support/call-desk/	service_bg@viewsoniceurope.com
Hrvatska	www.viewsoinceurope.com	http://www.viewsoniceurope.com/eu/support/call-desk/	service_hr@viewsoniceurope.com
Česká Republika	www.viewsoniceurope.com	www.viewsoniceurope.com/uk/support/call-desk/	service_cz@viewsoniceurope.com
Nederland	www.viewsoniceurope.com	http://www.viewsoniceurope.com/eu/support/call-desk/	service_nl@viewsoniceurope.com
Suomi	www.viewsoniceurope.com	http://www.viewsoniceurope.com/eu/support/call-desk/	service_fi@viewsoniceurope.com
France et autres pays francophones en Europe	www.viewsoniceurope.com/fr/	www.viewsoniceurope.com/fr/support/call-desk/	service_fr@viewsoniceurope.com
Canada	www.viewsonic.com	T (Numéro vert)= 1-866-463-4775	service.ca@viewsonic.com

Suisse	www.viewsoniceurope.com/de/	www.viewsoniceurope.com/de/support/call-desk/	service_ch@viewsoniceurope.com
Belgique (Français)	www.viewsoniceurope.com/fr/	www.viewsoniceurope.com/fr/support/call-desk/	service_be@viewsoniceurope.com
Luxembourg (Français)	www.viewsoniceurope.com/fr/	www.viewsoniceurope.com/fr/support/call-desk/	service_lu@viewsoniceurope.com
Deutschland	www.viewsoniceurope.com/de/	www.viewsoniceurope.com/de/support/call-desk/	service_deu@viewsoniceurope.com
Österreich	www.viewsoniceurope.com/de/	www.viewsoniceurope.com/de/support/call-desk/	service_at@viewsoniceurope.com
Schweiz (Deutsch)	www.viewsoniceurope.com/de/	www.viewsoniceurope.com/de/support/call-desk/	service_ch@viewsoniceurope.com
Ελλάδα	www.viewsoniceurope.com	www.viewsoniceurope.com/uk/support/call-desk/	service_gr@viewsoniceurope.com
Magyar Köztársaság	www.viewsoniceurope.com	www.viewsoniceurope.com/uk/support/call-desk/	service_hu@viewsoniceurope.com
Italia e altri paesi di lingua italiana in Europa	www.viewsoniceurope.com	www.viewsoniceurope.com/uk/support/call-desk/	service_it@viewsoniceurope.com
Spain	www.viewsoniceurope.com/es/	www.viewsoniceurope.com/es/support/call-desk/	service_es@viewsoniceurope.com
Latinoamérica (México)	www.viewsonic.com/la/	T= 001-8882328722	soporte@viewsonic.com
Italia e altri paesi di lingua italiana in Europa	www.viewsoniceurope.com	www.viewsoniceurope.com/uk/support/call-desk/	service_it@viewsoniceurope.com
Polska i inne kraje Europy Centralnej	www.viewsoniceurope.com	www.viewsoniceurope.com/uk/support/call-desk/	service_pl@viewsoniceurope.com
Portugal	www.viewsoniceurope.com	www.viewsoniceurope.com/uk/support/call-desk/	service_pt@viewsoniceurope.com
România	www.viewsoinceurope.com	www.viewsoniceurope.com/uk/support/call-desk/	service_ro@viewsoniceurope.com
Россия	www.viewsoniceurope.com/ru/	www.viewsoniceurope.com/ru/support/call-desk/	service_ru@viewsoniceurope.com
Беларусь (Русский)	www.viewsoniceurope.com/ru/	www.viewsoniceurope.com/ru/support/call-desk/	service_br@viewsoniceurope.com
Латвия (Русский)	www.viewsoniceurope.com/ru/	www.viewsoniceurope.com/ru/support/call-desk/	service_lv@viewsoniceurope.com
Srbija	www.viewsoniceurope.com	www.viewsoniceurope.com/uk/support/call-desk/	service_rs@viewsoniceurope.com
Slovensko	www.viewsoinceurope.com	www.viewsoniceurope.com/uk/support/call-desk/	service_sk@viewsoniceurope.com
Slovenija	www.viewsoinceurope.com	www.viewsoniceurope.com/uk/support/call-desk/	service_si@viewsoniceurope.com

Sverige	www.viewsoniceurope.com	www.viewsoniceurope.com/uk/ support/call-desk/	service_se@ viewsoniceurope.com
Türkiye	http://www.viewsoniceurope. com/tr/	www.viewsoniceurope.com/tr/ support/call-desk/	service_tr@ viewsoniceurope.com
Україна	www.viewsoniceurope.com	www.viewsoniceurope.com/uk/ support/call-desk/	service_ua@ viewsoniceurope.com
America			
Australia New Zealand	www.viewsonic.com.au	AUS= 1800 880 818 NZ= 0800 008 822	service@ au.viewsonic.com
Canada	www.viewsonic.com	T= 1-866-463-4775	service.ca@viewsonic. com
Latin America	www.viewsonic.com/la/	C= http://www.viewsonic.com/ la/soporte/servicio-tecnico	soporte@viewsonic. com
Middle East	ap.viewsonic.com/me/	Contact your reseller	service@ ap.viewsonic.com
Puerto Rico & Virgin Islands	www.viewsonic.com	T= 1-800-688-6688 (English) C= http://www.viewsonic.com/ la/soporte/servicio-tecnico	service.us@viewsonic. com soporte@viewsonic. com
South Africa	ap.viewsonic.com/za/	Contact your reseller	service@ ap.viewsonic.com
United States	www.viewsonic.com	T= 1-800-688-6688	service.us@viewsonic. com

Limited Warranty

ViewSonic® Display

What the warranty covers:

ViewSonic warrants its products to be free from defects in material and workmanship during the warranty period. If a product proves to be defective in material or workmanship during the warranty period, ViewSonic will, at its sole option, and as your sole remedy, repair or replace the product with a similar product. Replacement Product or parts may include remanufactured or refurbished parts or components. The repair or replacement unit or parts or components will be covered by the balance of the time remaining on the customer's original limited warranty and the warranty period will not be extended. ViewSonic provides no warranty for any third-party software whether included with the product or installed by the customer, installation of any unauthorized hardware parts or components (e.g. Projector Lamps). (Please refer to: "What the warranty does not cover" section)

How long the warranty is effective:

ViewSonic displays are warranted for between 1 and 3 years, depending on your country of purchase, for all parts including the light source and for all labour from the date of the first consumer purchase

Who the warranty protects:

This warranty is valid only for the first consumer purchaser.

What the warranty excludes and does not cover:

Any product on which the serial number has been defaced, modified or removed.

Damage, deterioration or malfunction resulting from:

1. Accident, misuse, neglect, fire, water, lightning, or other acts of nature, unauthorized product modification, or failure to follow instructions supplied with the product.
2. Repair or attempted repair by anyone not authorized by ViewSonic.
3. Damage to or loss of any programs, data or removable storage media.
4. Software or data loss occurring during repair or replacement.
5. Any damage of the product due to shipment.
6. Removal or installation of the product.
7. Causes external to the product, such as electric power fluctuations or failure.
8. Use of supplies or parts not meeting ViewSonic's specifications.
9. Normal wear and tear.
10. Failure of owner to perform periodic product maintenance as stated in User Guide, such as cleaning of user-cleanable projector filters.
11. Any other cause which does not relate to a product defect.
12. Damage caused by static (non-moving) images displayed for lengthy periods of time (also referred to as image burn-in).
13. Software - Any third-party software included with the product or installed by the customer.

14. Hardware/Accessories/Parts/Components - Installation of any unauthorized hardware, accessories, consumable parts or components (e.g. Projector Lamps).
15. Damage to, or abuse of, the coating on the surface of the display through inappropriate cleaning as described in product User Guide.
16. Removal, installation, and set-up service charges, including wall-mounting of product.

How to get service:

1. For information about receiving service under warranty, contact ViewSonic Customer Support (Please refer to Customer Support page). You will need to provide your product's serial number.
2. To obtain warranty service, you will be required to provide (a) the original dated sales slip, (b) your name, (c) your address, (d) a description of the problem, and (e) the serial number of the product.
3. Take or ship the product freight prepaid in the original container to an authorized ViewSonic service center or ViewSonic.
4. For additional information or the name of the nearest ViewSonic service center, contact ViewSonic.

Limitation of implied warranties:

There are no warranties, express or implied, which extend beyond the description contained herein including the implied warranty of merchantability and fitness for a particular purpose.

Exclusion of damages:

ViewSonic's liability is limited to the cost of repair or replacement of the product. ViewSonic shall not be liable for:

1. Damage to other property caused by any defects in the product, damages based upon inconvenience, loss of use of the product, loss of time, loss of profits, loss of business opportunity, loss of goodwill, interference with business relationships, or other commercial loss, even if advised of the possibility of such damages.
2. Any other damages, whether incidental, consequential or otherwise.
3. Any claim against the customer by any other party.
4. Repair or attempted repair by anyone not authorized by ViewSonic.

Effect of state law:

This warranty gives you specific legal rights, and you may also have other rights which vary from state to state. Some states do not allow limitations on implied warranties and/or do not allow the exclusion of incidental or consequential damages, so the above limitations and exclusions may not apply to you.

Sales outside the U.S.A. and Canada:

For warranty information and service on ViewSonic products sold outside of the U.S.A. and Canada, contact ViewSonic or your local ViewSonic dealer.

The warranty period for this product in mainland China (Hong Kong, Macao and Taiwan Excluded) is subject to the terms and conditions of the Maintenance Guarantee Card.

For users in Europe and Russia, full details of warranty provided can be found in www.viewsoniceurope.com under Support/Warranty Information.

Mexico Limited Warranty

ViewSonic® Display

What the warranty covers:

ViewSonic warrants its products to be free from defects in material and workmanship, under normal use, during the warranty period. If a product proves to be defective in material or workmanship during the warranty period, ViewSonic will, at its sole option, repair or replace the product with a like product. Replacement product or parts may include remanufactured or refurbished parts or components & accessories.

How long the warranty is effective:

ViewSonic LCD displays are warranted for between 1 and 3 years, depending on your country of purchase, for all parts including the light source and for all labour from the date of the first consumer purchase

Who the warranty protects:

This warranty is valid only for the first consumer purchaser.

What the warranty does not cover:

1. Any product on which the serial number has been defaced, modified or removed.
2. Damage, deterioration or malfunction resulting from:
 - a. Accident, misuse, neglect, fire, water, lightning, or other acts of nature, unauthorized product modification, unauthorized attempted repair, or failure to follow instructions supplied with the product.
 - b. Causes external to the product, such as electrical power fluctuations or failure.
 - c. Use of supplies or parts not meeting ViewSonic's specifications.
 - d. Normal wear and tear.
 - e. Any other cause which does not relate to a product defect.
3. Any product exhibiting a condition commonly known as "image burn-in" which results when a static image is displayed on the product for an extended period of time.
4. Removal, installation, insurance, and set-up service charges.

How to get service:

For information about receiving service under warranty, contact ViewSonic Customer Support (Please refer to the attached Customer Support page). You will need to provide your product's serial number, so please record the product information in the space provided below on your purchase for your future use. Please retain your receipt of proof of purchase to support your warranty claim.

For Your Records

Product Name: _____ Model Number: _____

Document Number: _____ Serial Number: _____

Purchase Date: _____ Extended Warranty Purchase? __ (Y/N)

If so, what date does warranty expire? _____

1. To obtain warranty service, you will be required to provide (a) the original dated sales slip, (b) your name, (c) your address, (d) a description of the problem, and (e) the serial number of the product.
2. Take or ship the product in the original container packaging to an authorized ViewSonic service center.
3. Round trip transportation costs for in-warranty products will be paid by ViewSonic.

Limitation of implied warranties:

There are no warranties, express or implied, which extend beyond the description contained herein including the implied warranty of merchantability and fitness for a particular purpose.

Exclusion of damages:

ViewSonic's liability is limited to the cost of repair or replacement of the product. ViewSonic shall not be liable for:

1. Damage to other property caused by any defects in the product, damages based upon inconvenience, loss of use of the product, loss of time, loss of profits, loss of business opportunity, loss of goodwill, interference with business relationships, or other commercial loss, even if advised of the possibility of such damages.
2. Any other damages, whether incidental, consequential or otherwise.
3. Any claim against the customer by any other party.
4. Repair or attempted repair by anyone not authorized by ViewSonic.

Contact Information for Sales & Authorized Service (Centro Autorizado de Servicio) within Mexico:	
Name, address, of manufacturer and importers: México, Av. de la Palma #8 Piso 2 Despacho 203, Corporativo Interpalmas, Col. San Fernando Huixquilucan, Estado de México Tel: (55) 3605-1099 http://www.viewsonic.com/la/soporte/index.htm	
NÚMERO GRATIS DE ASISTENCIA TÉCNICA PARA TODO MÉXICO: 001.866.823.2004	
Hermosillo: Distribuciones y Servicios Computacionales SA de CV. Calle Juarez 284 local 2 Col. Bugambilias C.P: 83140 Tel: 01-66-22-14-9005 E-Mail: disc2@hmo.megared.net.mx	Villahermosa: Compumantenimietnos Garantizados, S.A. de C.V. AV. GREGORIO MENDEZ #1504 COL, FLORIDA C.P. 86040 Tel: 01 (993) 3 52 00 47 / 3522074 / 3 52 20 09 E-Mail: compumantenimientos@prodigy.net.mx
Puebla, Pue. (Matriz): RENTA Y DATOS, S.A. DE C.V. Domicilio: 29 SUR 721 COL. LA PAZ 72160 PUEBLA, PUE. Tel: 01(52).222.891.55.77 CON 10 LINEAS E-Mail: datos@puebla.megared.net.mx	Veracruz, Ver.: CONEXION Y DESARROLLO, S.A DE C.V. Av. Americas # 419 ENTRE PINZÓN Y ALVARADO Fracc. Reforma C.P. 91919 Tel: 01-22-91-00-31-67 E-Mail: gacosta@qplus.com.mx
Chihuahua Soluciones Globales en Computación C. Magisterio # 3321 Col. Magisterial Chihuahua, Chih. Tel: 4136954 E-Mail: Cefe@soluglobales.com	Cuernavaca Compusupport de Cuernavaca SA de CV Francisco Leyva # 178 Col. Miguel Hidalgo C.P. 62040, Cuernavaca Morelos Tel: 01 777 3180579 / 01 777 3124014 E-Mail: aquevedo@compusupportcva.com
Distrito Federal: QPLUS, S.A. de C.V. Av. Coyoacán 931 Col. Del Valle 03100, México, D.F. Tel: 01(52)55-50-00-27-35 E-Mail : gacosta@qplus.com.mx	Guadalajara, Jal.: SERVICRECE, S.A. de C.V. Av. Niños Héroes # 2281 Col. Arcos Sur, Sector Juárez 44170, Guadalajara, Jalisco Tel: 01(52)33-36-15-15-43 E-Mail: mmiranda@servicrece.com
Guerrero Acapulco GS Computación (Grupo Sesicomp) Progreso #6-A, Colo Centro 39300 Acapulco, Guerrero Tel: 744-48-32627	Monterrey: Global Product Services Mar Caribe # 1987, Esquina con Golfo Pérsico Fracc. Bernardo Reyes, CP 64280 Monterrey N.L. México Tel: 8129-5103 E-Mail: aydeem@gps1.com.mx
MERIDA: ELECTROSER Av Reforma No. 403Gx39 y 41 Mérida, Yucatán, México CP97000 Tel: (52) 999-925-1916 E-Mail: rrrb@sureste.com	Oaxaca, Oax.: CENTRO DE DISTRIBUCION Y SERVICIO, S.A. de C.V. Murguía # 708 P.A., Col. Centro, 68000, Oaxaca Tel: 01(52)95-15-15-22-22 Fax: 01(52)95-15-13-67-00 E-Mail: gpotai2001@hotmail.com
Tijuana: STD Av Ferrocarril Sonora #3780 L-C Col 20 de Noviembre Tijuana, Mexico	FOR USA SUPPORT: ViewSonic Corporation 381 Brea Canyon Road, Walnut, CA. 91789 USA Tel: 800-688-6688 E-Mail: http://www.viewsonic.com

LCD Mexico Warranty Term Template In UG

VSC_TEMP_2008



ViewSonic®