

PM-400 User's Guide

Contents

PM-400 User's Guide	9
Product Basics	10
Using the Control Panel	10
Control Panel Buttons.....	11
The LCD Screen	12
Changing LCD Screen Language.....	12
Turning Off Control Panel Sounds.....	12
Product Parts Locations	13
Printer Parts.....	13
The Power Off and Sleep Timers	15
Changing the Power Off Timer Setting from the Control Panel.....	15
Changing the Sleep Timer Setting from the Control Panel	16
Changing the Power and Sleep Timer Settings - Windows.....	18
Changing the Power and Sleep Timer Settings - OS X.....	19
Epson Connect Solutions for Smartphones, Tablets, and More	21
Using Epson Email Print	21
Using the Epson iPrint Mobile App	21
Using Epson Remote Print	22
Using AirPrint	22
Using Google Cloud Print.....	23
Setting Up Google Cloud Print on a Chromebook	24
Using the Mopria Print Service	25
Wi-Fi Networking	26
Wi-Fi Infrastructure Mode Setup.....	26
Selecting Wireless Network Settings from the Control Panel	27
Wi-Fi Direct Mode Setup	29
Enabling Wi-Fi Direct Mode.....	30
Wi-Fi Protected Setup (WPS).....	32
Using WPS to Connect to a Network.....	33
Viewing the Network Status	33

Changing or Updating Network Connections	35
Accessing the Web Config Utility	35
Changing a USB Connection to a Wi-Fi Connection.....	35
Connecting to a New Wi-Fi Router	36
Disabling Wi-Fi Features	36
Loading Paper	38
Loading Paper in the Paper Feed Slot.....	38
Paper Loading Capacity	41
Available Epson Papers	41
Borderless Paper Type Compatibility	42
Paper or Media Type Settings - Product Software.....	43
Selecting the Paper Source Settings - Control Panel	43
Paper Type Settings - Control Panel	44
Printing from a Computer	45
Printing with Windows	45
Selecting Basic Print Settings - Windows	45
Print Quality Options - Windows	47
Multi-Page Printing Options - Windows.....	48
Selecting Double-sided Printing Settings - Windows	48
Double-sided Printing Options - Windows.....	50
Selecting Additional Layout and Print Options - Windows	50
Custom Color Correction Options - Windows.....	52
Image Options and Additional Settings - Windows.....	53
Selecting a Printing Preset - Windows.....	54
Selecting Extended Settings - Windows	55
Extended Settings - Windows	56
Printing Your Document or Photo - Windows.....	57
Checking Print Status - Windows	59
Selecting Default Print Settings - Windows.....	59
Changing the Language of the Printer Software Screens	60
Changing Automatic Update Options	61
Printing with OS X	62
Selecting Basic Print Settings - OS X	63

Print Quality Settings - OS X.....	67
Print Options - OS X.....	67
Selecting Page Setup Settings - OS X.....	68
Selecting Print Layout Options - OS X.....	69
Sizing Printed Images - OS X.....	70
Managing Color - OS X.....	70
Color Matching and Color Options - OS X.....	71
Selecting Printing Preferences - OS X.....	72
Printing Preferences - OS X.....	73
Printing Your Document or Photo - OS X.....	74
Checking Print Status - OS X.....	74
Cancelling Printing Using a Product Button.....	75
Using Memory Cards With Your Product	76
Inserting a Memory Card.....	76
Memory Card Types	77
Memory Card File Specifications	77
Removing a Memory Card.....	78
Printing from a Memory Card	78
Viewing and Printing Photos.....	78
Printing Photo Layouts	80
Photo Layout Options	82
Print Setting Options.....	83
Photo Adjustment Options.....	84
Transferring Photos on a Memory Card	85
Transferring Photos from a Memory Card to Your Computer	85
Using an External Device with Your Product	87
Printing from a Camera	87
Selecting Print and Photo Adjustment Settings	87
Connecting and Printing from a Camera	90
Printing from a Camera Wirelessly	91
Viewing or Printing from a USB Flash Drive or External Device	91
USB Device File Specifications	92
Connecting and Using a USB Flash Drive or External Device	92

Replacing the Ink Cartridge	94
Check Cartridge Status	94
Checking Cartridge Status on the LCD Screen.....	94
Checking Cartridge Status with Windows.....	95
Checking Cartridge Status with OS X.....	98
Purchase Epson Ink Cartridges.....	99
Ink Cartridge Part Numbers	99
Removing and Installing the Ink Cartridge.....	100
Adjusting Print Quality.....	105
Print Head Maintenance.....	105
Print Head Nozzle Check.....	105
Checking the Nozzles Using the Product Control Panel	105
Checking the Nozzles Using a Computer Utility	107
Print Head Cleaning	109
Cleaning the Print Head Using the Product Control Panel	110
Cleaning the Print Head Using a Computer Utility.....	111
Print Head Alignment	113
Aligning the Print Head Using the Product Control Panel	114
Cleaning the Paper Path	115
Transporting and Cleaning Your Product	117
Carrying and Transporting Your Product.....	117
Cleaning Your Product	118
Solving Problems	120
Checking for Software Updates.....	120
Product Status Messages	121
Running a Product Check	122
Resetting Control Panel Defaults	124
Solving Setup Problems	125
Noise After Ink Installation.....	125
Software Installation Problems	125
USB Connection Problems.....	126
Solving Network Problems	126
Product Cannot Connect to a Wireless Router or Access Point	126

Network Software Cannot Find Product on a Network.....	128
Product Does Not Appear in OS X Printer Window.....	128
Cannot Print Over a Network.....	129
Solving Paper Problems.....	130
Paper Feeding Problems.....	130
Paper Jam Problems Inside the Product.....	131
Paper Ejection Problems.....	133
Solving Problems Printing from a Computer.....	133
Nothing Prints.....	134
Product Icon Does Not Appear in Windows Taskbar.....	134
Printing is Slow.....	135
Solving Page Layout and Content Problems.....	136
Inverted Image.....	136
Too Many Copies Print.....	137
Blank Pages Print.....	137
Incorrect Margins on Printout.....	138
Border Appears on Borderless Prints.....	138
Incorrect Characters Print.....	139
Incorrect Image Size or Position.....	139
Slanted Printout.....	140
Solving Print Quality Problems.....	140
White or Dark Lines in Printout.....	140
Blurry or Smearred Printout.....	141
Faint Printout or Printout Has Gaps.....	142
Grainy Printout.....	143
Incorrect Colors.....	144
Solving Memory Card Problems.....	145
Memory Card Does Not Fit Into a Slot.....	145
Cannot View or Print Photos from a Memory Card or Device.....	145
Cannot Transfer Photos To or From a Memory Card or Device.....	146
Uninstall Your Product Software.....	146
Uninstalling Printing Software - Windows.....	147
Uninstalling Product Software - OS X.....	147

Where to Get Help.....	148
Technical Specifications	150
Windows System Requirements	150
OS X System Requirements.....	151
Paper Specifications	151
Printable Area Specifications	152
Ink Cartridge Specifications.....	154
Memory Card Specifications	154
External USB Device Specifications.....	155
Dimension Specifications	156
Electrical Specifications	156
Environmental Specifications	157
Interface Specifications	157
Network Interface Specifications	157
Safety and Approvals Specifications	158
Notices	159
General Printer Safety Instructions.....	159
Ink Cartridge Safety Instructions.....	160
LCD Screen Safety Instructions.....	161
Wireless Connection Safety Instructions	161
FCC Compliance Statement.....	162
Trademarks	162
Copyright Notice.....	163
A Note Concerning Responsible Use of Copyrighted Materials.....	164
Default Delay Times for Power Management for Epson Products	164
Copyright Attribution	164

PM-400 User's Guide

Welcome to the PM-400 *User's Guide*.

For a printable PDF copy of this guide, [click here](#).

Product Basics

See these sections to learn about the basic features of your product.

[Using the Control Panel](#)

[Product Parts Locations](#)

[The Power Off and Sleep Timers](#)

[Epson Connect Solutions for Smartphones, Tablets, and More](#)

[Using AirPrint](#)

[Using Google Cloud Print](#)

[Using the Mopria Print Service](#)

Using the Control Panel

See these sections to learn about the control panel and select control panel settings.

[Control Panel Buttons](#)

[The LCD Screen](#)





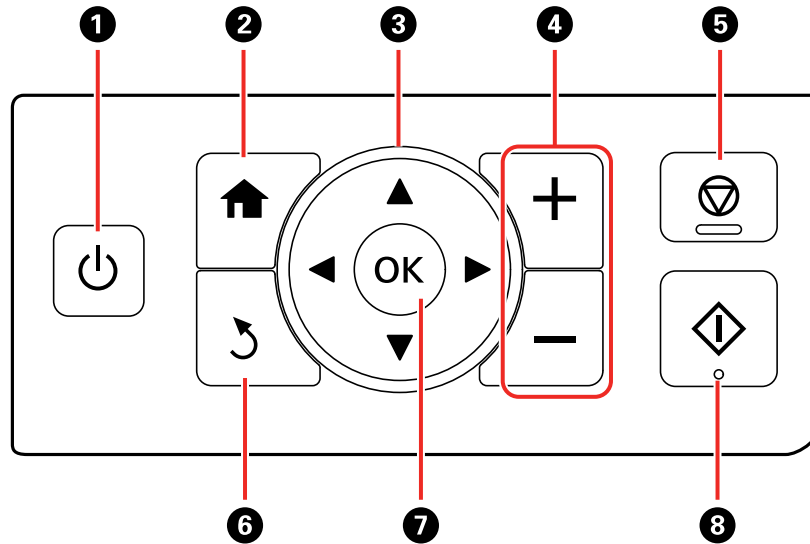

[Changing LCD Screen Language](#)

[Turning Off Control Panel Sounds](#)

Parent topic: [Product Basics](#)

Control Panel Buttons



- 1 The  power button
- 2 The  home button
- 3 The arrow buttons; navigate menus
- 4 The  and  buttons; increase or decrease the number of copies
- 5 The  stop button
- 6 The  back button
- 7 The **OK** button
- 8 The  start button

Parent topic: [Using the Control Panel](#)

The LCD Screen

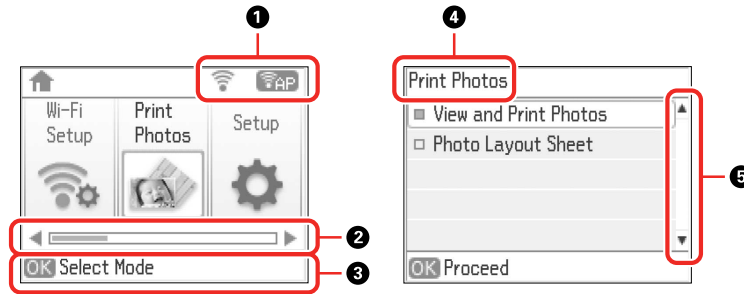

- 1 Displays network status
- 2 You can scroll left or right when these arrows are displayed
- 3 Displays available button options
- 4 Screen name
- 5 You can scroll up or down when these arrows are displayed

Parent topic: [Using the Control Panel](#)

Changing LCD Screen Language

You can change the language used on the LCD screen.

1. Press the  home button, if necessary.
2. Press the arrow buttons to select **Setup** and press the **OK** button.
3. Select **Printer Setup** and press the **OK** button.
4. Select **Language** and press the **OK** button.
5. Select a language and press the **OK** button.

Parent topic: [Using the Control Panel](#)

Turning Off Control Panel Sounds

You can turn off the sound heard when you press buttons on the control panel.

1. Press the  home button, if necessary.

2. Press the arrow buttons to select **Setup** and press the **OK** button.
3. Select **Printer Setup** and press the **OK** button.
4. Select **Sound** and press the **OK** button.
5. Select **Button Press** and press the **OK** button.
6. Select **Off** and press the **OK** button.

Parent topic: [Using the Control Panel](#)

Product Parts Locations

See these sections to identify the parts on your product.

[Printer Parts](#)

Parent topic: [Product Basics](#)

Printer Parts

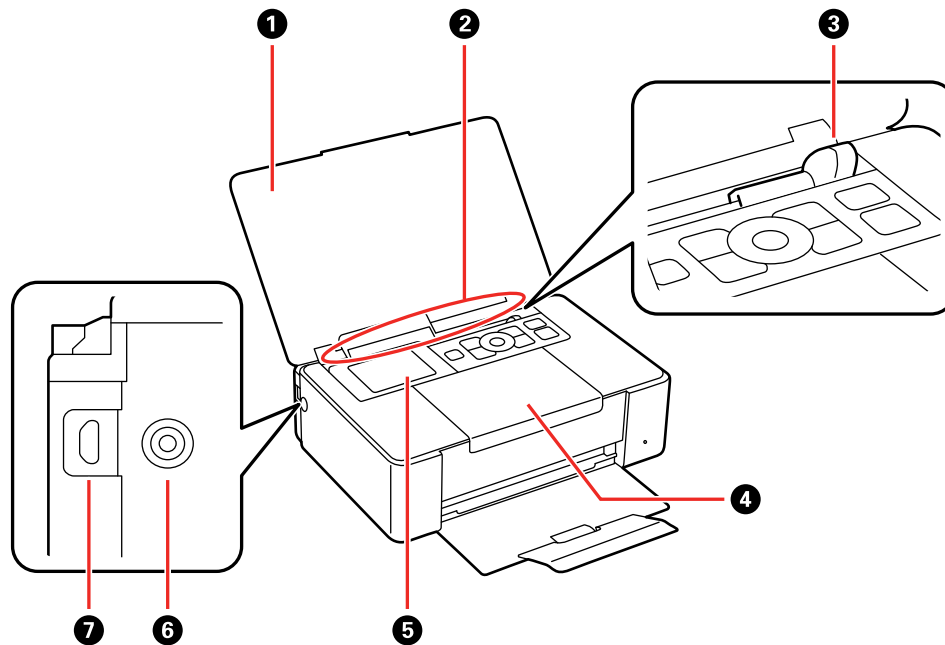

- 1 Printer cover
- 2 Rear paper feed
- 3 Edge guide
- 4 Inner cover
- 5 LCD screen
- 6 Power inlet
- 7 Micro USB port

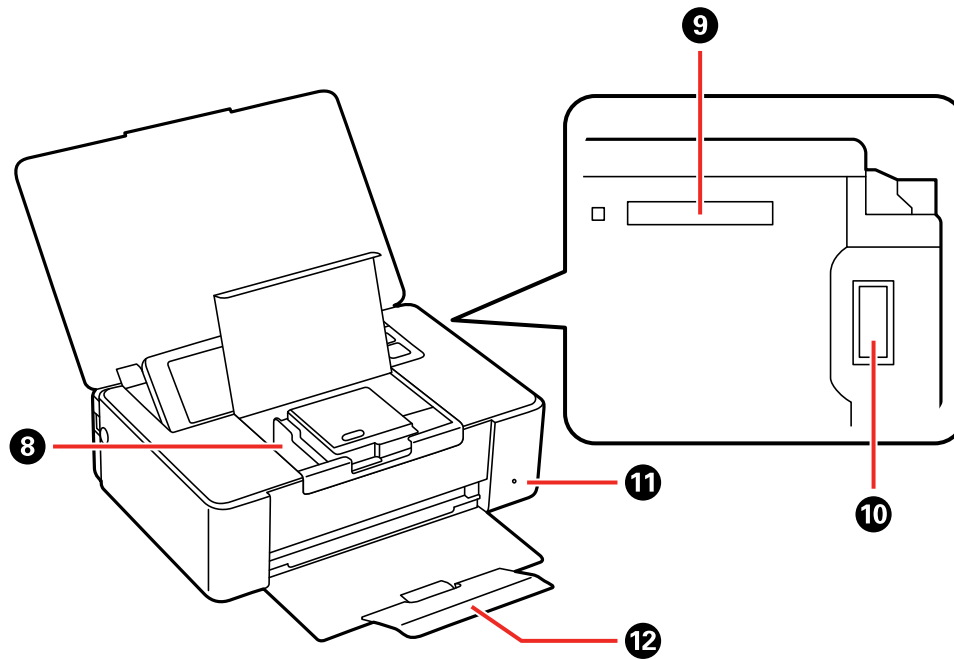

- 8 Ink cartridge holder (do not remove)
- 9 Memory card slot
- 10 USB port
- 11 Power light

Parent topic: [Product Parts Locations](#)

The Power Off and Sleep Timers

The product enters sleep mode or turns off automatically if it is not used for a period of time. You can adjust the time period before power management, but increasing the time reduces the product's energy efficiency.

[Changing the Power Off Timer Setting from the Control Panel](#)

[Changing the Sleep Timer Setting from the Control Panel](#)

[Changing the Power and Sleep Timer Settings - Windows](#)

[Changing the Power and Sleep Timer Settings - OS X](#)

Parent topic: [Product Basics](#)

Changing the Power Off Timer Setting from the Control Panel

You can use the product's control panel to change the time period before the printer turns off automatically.

1. Press the  home button, if necessary.
2. Press the arrow buttons to select **Setup** and press the **OK** button.
3. Select **Printer Setup** and press the **OK** button.

You see this screen:

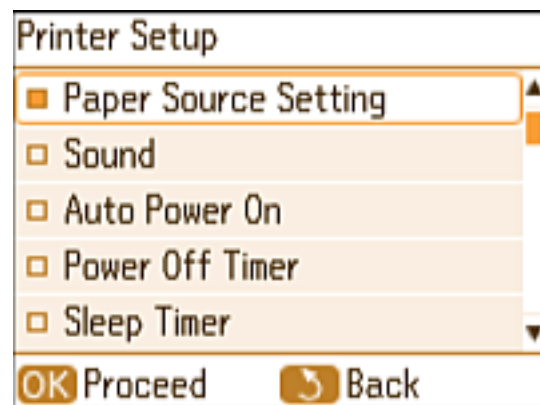

4. Select **Power Off Timer** and press the **OK** button.

You see this screen:

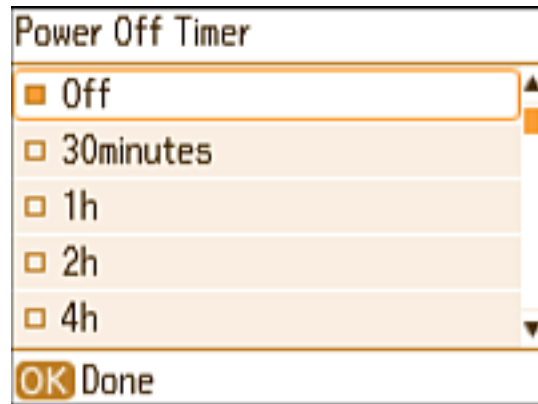

5. Select the time period you want before the product automatically turns off when it is not in use and press the **OK** button.
6. Press the **Home** button to exit.

Parent topic: [The Power Off and Sleep Timers](#)

Changing the Sleep Timer Setting from the Control Panel

You can use the product's control panel to change the time period before the product enters sleep mode.

1. Press the **Home** button, if necessary.
2. Press the arrow buttons to select **Setup** and press the **OK** button.
3. Select **Printer Setup** and press the **OK** button.

You see this screen:

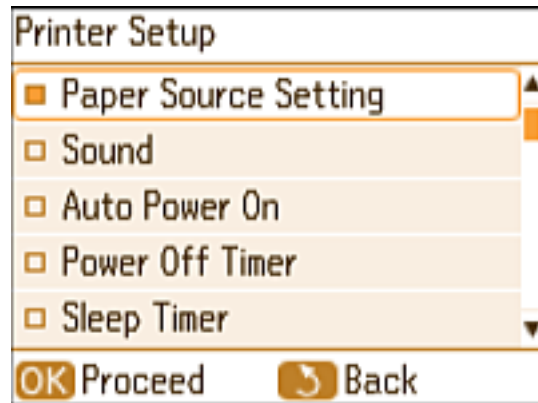

4. Select **Sleep Timer** and press the **OK** button.

You see this screen:



5. Select the time period you want before the product goes to sleep and press the **OK** button.
6. Press the  home button to exit.

Parent topic: [The Power Off and Sleep Timers](#)

Changing the Power and Sleep Timer Settings - Windows

You can use the printer software to change the time period before the product enters sleep mode or turns off automatically.

1. Make sure your product is turned on.
2. Access the Windows Desktop and right-click the product icon in the Windows taskbar.
3. Select **Printer Settings**.
4. Click the **Maintenance** tab.
5. Click the **Printer and Option Information** button.

You see this screen:

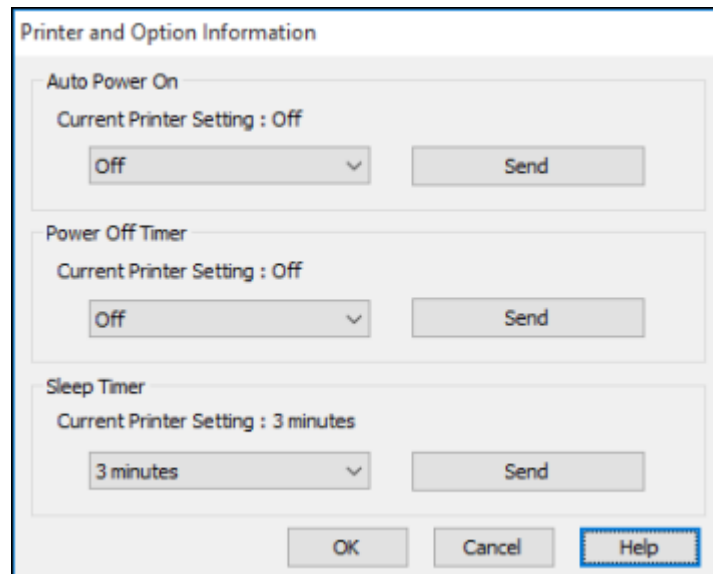

The screenshot shows a dialog box titled "Printer and Option Information". It contains three sections, each with a "Current Printer Setting" and a "Send" button:

- Auto Power On:** Current Printer Setting : Off. The dropdown menu is set to "Off".
- Power Off Timer:** Current Printer Setting : Off. The dropdown menu is set to "Off".
- Sleep Timer:** Current Printer Setting : 3 minutes. The dropdown menu is set to "3 minutes".

At the bottom of the dialog box, there are three buttons: "OK", "Cancel", and "Help". The "Help" button is highlighted with a blue border.

6. Turn on the **Auto Power On** setting if you want the product to automatically turn on when it receives a print job.

Note: This setting works with print jobs sent over a USB or network connection. Enabling this setting slightly increases the product's power consumption in standby mode.

7. Click **Send**.

8. Select the length of time after which you want the product to automatically turn off when it is not in use as the **Power Off Timer** setting.
9. Click **Send**.
10. Select the time period you want before the product goes to sleep as the **Sleep Timer** setting.
11. Click **Send**.
12. Click **OK** to close the open program windows.

Parent topic: [The Power Off and Sleep Timers](#)

Changing the Power and Sleep Timer Settings - OS X

You can use the printer software to change the time period before the product enters sleep mode or turns off automatically.

1. Make sure your product is turned on.
2. In the Apple menu or the Dock, select **System Preferences**. Select **Print & Fax**, **Print & Scan**, or **Printers & Scanners**, select your product, and select **Options & Supplies**. Select **Utility** and select **Open Printer Utility**.
3. Select **Printer Settings**.

You see this window:

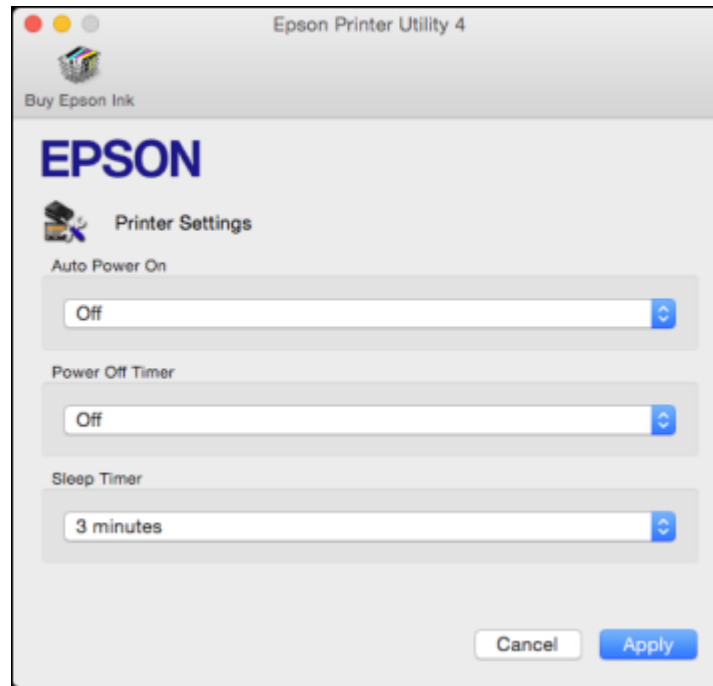

4. Turn on the **Auto Power On** setting if you want the product to automatically turn on when it receives a print job.

Note: This setting works with print jobs sent over a USB or network connection. Enabling this setting slightly increases the product's power consumption in standby mode.

5. Click **Send**.
6. Select the length of time after which you want the product to automatically turn off when it is not in use as the **Power Off Timer** setting.
7. Select the time period you want before the product goes to sleep as the **Sleep Timer** setting.
8. Click **Apply**.
9. Close the Printer Settings window.

Parent topic: [The Power Off and Sleep Timers](#)

Epson Connect Solutions for Smartphones, Tablets, and More

You can print photos from your home, office, or even across the globe. You can use your smartphone, tablet, or computer. Epson offers these solutions to print from anywhere: Epson Email Print, Epson iPrint Mobile App, and Epson Remote Print.

[Using Epson Email Print](#)

[Using the Epson iPrint Mobile App](#)

[Using Epson Remote Print](#)

Parent topic: [Product Basics](#)

Related tasks

[Using AirPrint](#)

[Using Google Cloud Print](#)

[Using the Mopria Print Service](#)

Using Epson Email Print

With Epson Email Print, you can print from any device that can send email, such as your smartphone, tablet, or laptop. Just activate your product's unique email address. When you want to print, attach a photo to an email and send it to your product.

1. Set up your product for network printing. See the link below.
2. If you did not already set up Email Print when you installed your product software, visit epson.com/connect to learn more about Email Print, check compatibility, and get detailed setup instructions.
3. Send an email with attachments to your product's Email Print address.

Note: Both the email and any attachments print by default. You can change these printing options by logging into your Epson Connect account.

Parent topic: [Epson Connect Solutions for Smartphones, Tablets, and More](#)

Related topics

[Wi-Fi Networking](#)

Using the Epson iPrint Mobile App

Use this free Apple and Android app to print to nearby Epson networked products. The Epson iPrint Mobile App lets you print photos over a wireless network.

1. Set up your product on a network. See the link below.
2. Visit [epson.com/connect](https://www.epson.com/connect) to learn more about Epson iPrint and check the compatibility of your mobile device.
3. Download Epson iPrint from the Apple App Store or Google Play.
4. Connect your mobile device to the same wireless network that your product is using.
5. Print from your mobile device to your Epson product.

Parent topic: [Epson Connect Solutions for Smartphones, Tablets, and More](#)

Related topics

[Wi-Fi Networking](#)

Using Epson Remote Print

With Epson Remote Print software, you can print to an Epson Email-enabled product anywhere in the world.

1. Set up your product for network printing. See the link below.
2. Visit [epson.com/connect](https://www.epson.com/connect) to learn more about Remote Print and how to download the software.
3. Download and install the Remote Print software.
4. Obtain the email address and optional access key of the Epson product you want to use for printing, and enter this address during Remote Print setup.
5. Select the print command in your application and choose the Remote Print driver for your Epson product.

Parent topic: [Epson Connect Solutions for Smartphones, Tablets, and More](#)

Related topics

[Wi-Fi Networking](#)

Using AirPrint

AirPrint enables instant wireless printing from iPhone, iPad, and iPod touch with the latest version of iOS, and Mac with the latest version of OS X.



Note: If you disabled paper configuration messages on your product control panel, you cannot use AirPrint. See the link below to enable the messages, if necessary.

1. Load paper in your product.
2. Set up your product for wireless printing. See the link below.
3. Connect your Apple device to the same wireless network that your product is using.
4. Print from your device to your product.

Note: For details, see the AirPrint page on the Apple website.

Parent topic: [Product Basics](#)

Related tasks

[Selecting the Paper Source Settings - Control Panel](#)

Related topics

[Epson Connect Solutions for Smartphones, Tablets, and More](#)

[Wi-Fi Networking](#)

Using Google Cloud Print

With a Google Account, you can print from your Apple or Android device to your Epson product. You can also print from Chromebooks and the Google Chrome browser without drivers or cables.

Set up your Epson product for network printing. See the link below.

Note: Make sure your Epson printer and computer are connected to the same network before starting the Google Cloud Print setup.

1. Connect your device to the same network that your Epson product is using.
2. Check your network status.
3. Note your product's IP address.
4. Enter the IP address into the address bar of a web browser.
5. Select the **Google Cloud Print Services** option.

Note: If you don't see the **Google Cloud Print Services** option, turn your product off and back on. If the option still doesn't appear, select the **Firmware Update** option and follow the on-screen instructions to update your product.

6. Click **Register**.
7. Select the checkbox to agree to the Usage Advisory and click **Next**.
8. Click **OK** to launch the sign-in page.
A separate browser window opens.
9. Enter your Google Account username and password and click **Sign in**, or, if you don't have an account, click **Sign up for a new Google Account** and follow the on-screen instructions.
10. Click **Finish printer registration** to complete setup and print a test page.
Your product is now linked to your Google Account and can be accessed from any Chromebook, computer, Apple or Android device with Internet access. Visit [Epson Support](#) for more information on using Google Cloud Print, or the [Google Cloud Print](#) website for a list of [supported apps](#).

[Setting Up Google Cloud Print on a Chromebook](#)

Parent topic: [Product Basics](#)

Related tasks

[Viewing the Network Status](#)

Related topics

[Epson Connect Solutions for Smartphones, Tablets, and More](#)
[Wi-Fi Networking](#)

Setting Up Google Cloud Print on a Chromebook

With a Google Account, you can print from a Chromebook without drivers or cables.

Set up your Epson product for network printing. See the link below.

Note: Make sure your Epson product is connected to your wireless network before starting the Google Cloud Print setup.

1. Turn on your Chromebook and connect it to the same wireless network as your product.

Note: See your Chromebook's documentation for details on connecting to a network.

2. Do one of the following:
 - Click **Add to Cloud Print** in the notification that appears in the corner of your Chromebook screen.

Note: If you do not see a notification, check to see if a number appears in the status area at the lower-right corner of the screen. Click this number to open the notifications menu, then click **Add to Cloud Print**.

- Open a web browser and enter **chrome://devices** in the address bar. Skip to step 4.
 - If you see a registration confirmation screen instead, click **Register**.
3. Click **Add Device**.
 4. Click the **Register** button that appears next to your product.
 5. Click **Register** on the confirmation screen. Your product's LCD screen displays a confirmation message.
 6. Select **OK** or press the **OK** button on your product to confirm the Google Cloud Print connection and print a test page.

Your product is now linked to your Google Account and can be accessed from any Chromebook, iPhone, or Android phone with Internet access. For more information on using Google Cloud Print, visit [Epson Support](#).

Parent topic: [Using Google Cloud Print](#)

Related topics

[Wi-Fi Networking](#)

Using the Mopria Print Service

You can use the Mopria Print Service to print from your Android phone or tablet (Android v4.4 or later) to your Epson product or any Mopria-certified product from other manufacturers. You can download the Mopria Print Service from Google Play.

Note: For details on the Mopria Print Service, [click here](#) (website available in English only).

Parent topic: [Product Basics](#)

Related topics

[Epson Connect Solutions for Smartphones, Tablets, and More](#)

[Wi-Fi Networking](#)

Wi-Fi Networking

See these sections to use your product on a Wi-Fi network.

[Wi-Fi Infrastructure Mode Setup](#)

[Wi-Fi Direct Mode Setup](#)

[Wi-Fi Protected Setup \(WPS\)](#)

[Viewing the Network Status](#)

[Changing or Updating Network Connections](#)

Wi-Fi Infrastructure Mode Setup

You can set up your product to communicate with your computer using a wireless router or access point. The wireless router or access point can be connected to your computer over a wireless or wired network.

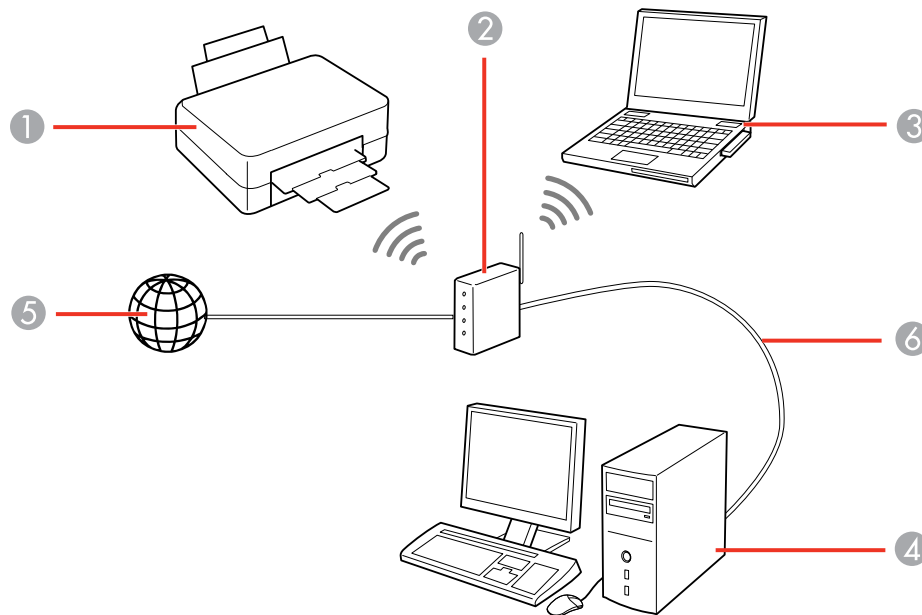

- 1 Epson product
- 2 Wireless router or access point

- 3 Computer with a wireless interface
- 4 Computer
- 5 Internet
- 6 Ethernet cable (used only for wired connection to the wireless router or access point)

Selecting Wireless Network Settings from the Control Panel

Parent topic: [Wi-Fi Networking](#)

Selecting Wireless Network Settings from the Control Panel

You can select or change wireless network settings using your product control panel.

To install your product on a wireless network, follow the instructions on the *Start Here* sheet and install the necessary software. The installer program guides you through network setup.

1. Press the  home button, if necessary.
2. Press the arrow buttons to select **Wi-Fi Setup** and press the **OK** button.

You see this screen:

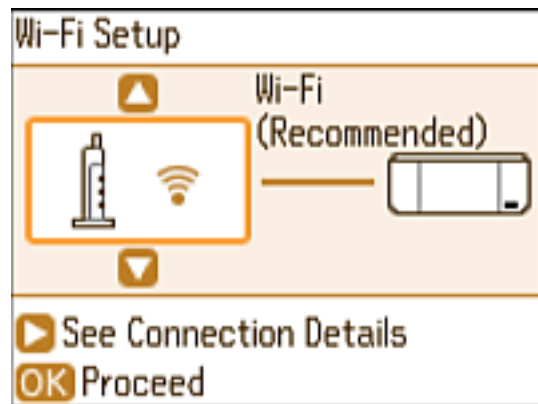

3. Press the **OK** button to select **Wi-Fi (Recommended)**.
4. Press the **OK** button again to proceed.
5. Select **Wi-Fi Setup Wizard** and press the **OK** button.

6. Press the arrow buttons to select the name of your wireless network and press the **OK** button. If you do not see your wireless network's name, you can enter it manually.

Note: To enter the wireless network name manually, select **Other Networks** and press the **OK** button. Enter your network name as described in the next step.

7. If you see the following screen, enter your wireless password (or network name and then password).

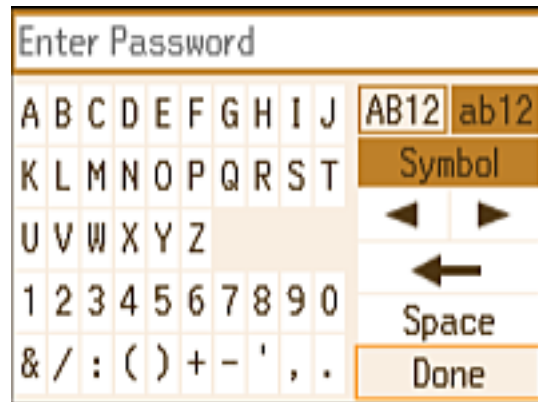

- Press the arrow buttons to highlight a character or a function button displayed on the keypad. Then press the **OK** button to select it.
 - To change the case of letters or select symbols, select **AB12** (uppercase), **ab12** (lowercase), or **Symbol** and press the **OK** button.
 - To enter a space, select **Space** and press the **OK** button.
 - To delete characters, select the back arrow and press the **OK** button.
 - When you finish entering characters, select **Done** and press the **OK** button.
8. Press the **OK** button to confirm Wi-Fi settings.
 9. If you want to print a network status report, press the \diamond start button. (Otherwise, press the **OK** button.)

Your product should now be connected to the network.

Note: If the Wi-Fi connection symbol is not lit or does not appear on the LCD screen, you may have selected the wrong network name or entered the password incorrectly. Repeat these steps to try again.

Parent topic: [Wi-Fi Infrastructure Mode Setup](#)

Related topics

[Changing or Updating Network Connections](#)

Wi-Fi Direct Mode Setup

You can set up your product to communicate directly with your computer or another device without requiring a wireless router or access point.

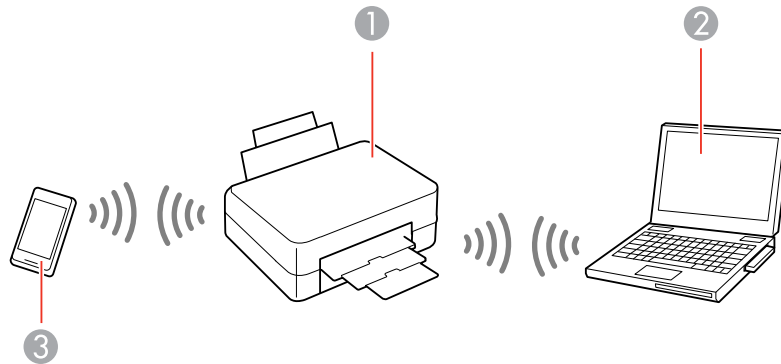

- 1 Epson product
- 2 Computer with a wireless interface
- 3 Other wireless device

You can select one of these modes to communicate with your computer or device:

Access point mode

The product itself acts as the network access point for up to 4 devices. When operating in this mode, your product displays an **AP** connection symbol on the LCD screen.

Peer-to-peer mode

The product communicates one-to-one with another Wi-Fi Direct capable device. When operating in this mode, your product displays a **Direct** or **D** connection symbol on the LCD screen.

To disconnect a peer-to-peer mode connection, release the connection to your product from your computer or other device.

To enable peer-to-peer mode, you must select it from the Web Config Utility, under **WiFi/Network Settings > Services > Wi-Fi Direct**.

[Enabling Wi-Fi Direct Mode](#)

Parent topic: [Wi-Fi Networking](#)

Related tasks

[Accessing the Web Config Utility](#)

Enabling Wi-Fi Direct Mode

You can enable Wi-Fi Direct mode to allow direct communication between your product and computer or other devices without a wireless router or access point.

1. Press the  home button, if necessary.
2. Press the arrow buttons to select **Wi-Fi Setup** and press the **OK** button.

You see this screen:

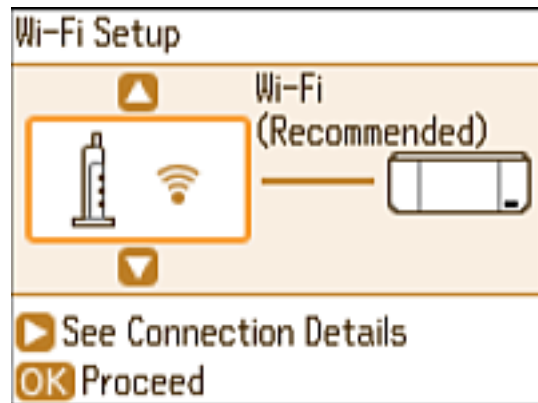

3. Select **Wi-Fi Direct** and press the **OK** button.
4. Press the **OK** button again to proceed.

5. Press the down arrow button to change the password.

Note: If you have already connected devices or computers to your product via Wi-Fi Direct, they will be disconnected when you change the password.

6. Select **Yes** and press the **OK** button.
7. Enter your new Wi-Fi Direct password.

Note: Your password must be at least 8 and no more than 22 characters long.

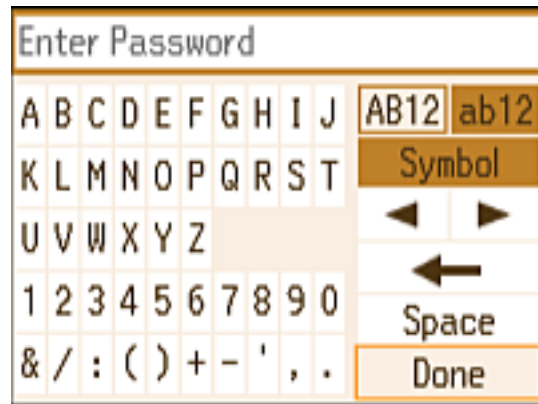

- Press the arrow buttons to highlight a character or a function button displayed on the keypad. Then press the **OK** button to select it.
- To change the case of letters or select symbols, select **AB12** (uppercase), **ab12** (lowercase), or **Symbol** and press the **OK** button.
- To enter a space, select **Space** and press the **OK** button.
- To delete characters, select the back arrow and press the **OK** button.
- When you finish entering characters, select **Done** and press the **OK** button.

8. Press the down arrow button to view the Wi-Fi network name and password you selected.

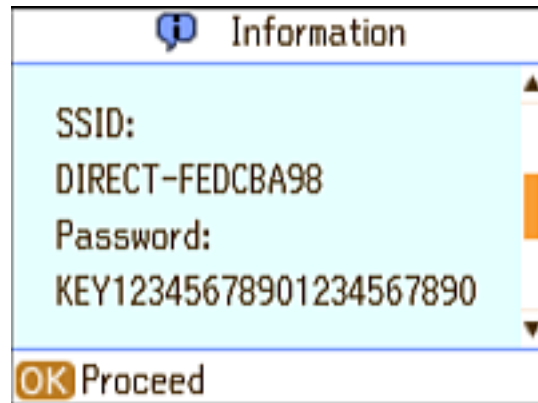

9. Use your computer or wireless device to select the Wi-Fi network name (SSID) displayed on the LCD screen, then enter the password shown.
10. Press the **OK** button to exit.

You see either an **AP** or **Direct** connection symbol on the LCD screen and should be able to print directly to your product from your computer or device.

Note: If the **AP** or **Direct** connection symbol is not displayed on the LCD screen, Wi-Fi Direct mode is not enabled. Repeat these steps to try again.

Parent topic: [Wi-Fi Direct Mode Setup](#)

Wi-Fi Protected Setup (WPS)

If your network uses a WPS-enabled wireless router or access point, you can quickly connect your product to the network using Wi-Fi Protected Setup (WPS).

Note: To check if your router is WPS-enabled, look for a button labeled **WPS** on your router or access point. If there is no hardware button, there may be a virtual WPS button in the software for the device. Check your network product documentation for details.

[Using WPS to Connect to a Network](#)

Parent topic: [Wi-Fi Networking](#)

Using WPS to Connect to a Network

If you have a WPS-enabled wireless router or access point, you can use Wi-Fi Protected Setup (WPS) to connect your product to the network.

1. On the product, press the **Home** button, if necessary.
2. Press the arrow buttons to select **Wi-Fi Setup** and press the **OK** button.

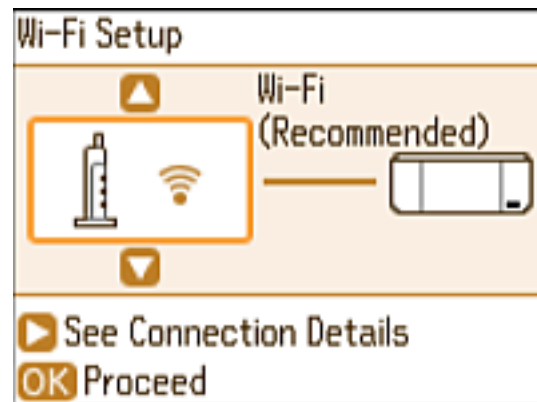

3. Press the **OK** button to select **Wi-Fi (Recommended)**.
4. Press the **OK** button again to proceed.
5. Select **Push Button Setup (WPS)** and press the **OK** button.
6. Follow the instructions on the LCD screen to complete WPS setup.

Your product should now display a WiFi symbol on the LCD screen. If it does not, repeat these steps to try again.

Parent topic: [Wi-Fi Protected Setup \(WPS\)](#)

Viewing the Network Status

You can view the product's network status to help you determine the causes of any problems you may have using your product on a network.

1. Press the **Home** button, if necessary.
2. Press the arrow buttons to select **Setup** and press the **OK** button.
3. Select **Network Settings** and press the **OK** button.

You see this screen:

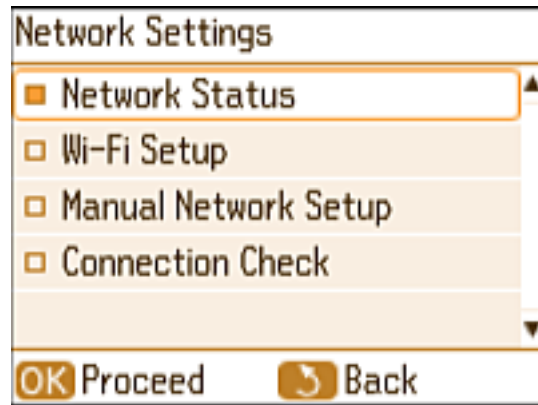

4. Select **Network Status** and press the **OK** button.

You see a screen like this:

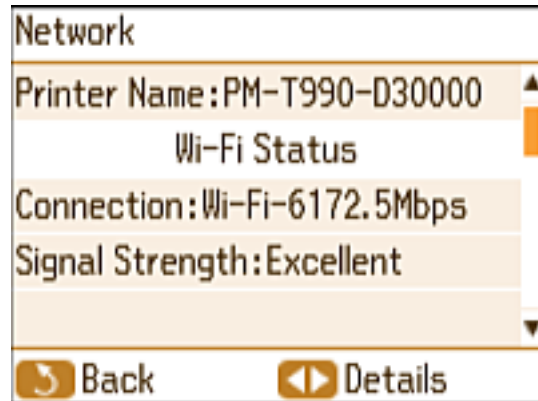

Note: If you are connected to a network, the signal strength is displayed.

5. Press the up or down arrow button to view the product's network status. To view additional network details, press the left or right arrow button and select one of the options shown.

Parent topic: [Wi-Fi Networking](#)

Changing or Updating Network Connections

See these sections to change or update how your product connects to a network.

[Accessing the Web Config Utility](#)

[Changing a USB Connection to a Wi-Fi Connection](#)

[Connecting to a New Wi-Fi Router](#)

[Disabling Wi-Fi Features](#)

Parent topic: [Wi-Fi Networking](#)

Related tasks

[Selecting Wireless Network Settings from the Control Panel](#)

[Selecting Wireless Network Settings from the Control Panel](#)

Accessing the Web Config Utility

You can select your product's network settings and confirm its operating status using a web browser. You do this by accessing your product's built-in Web Config utility from a computer or other device that is connected to the same network as your product.

1. Check your network status.
2. Note your product's IP address.
3. On a computer or other device connected to the same network as your product, open a web browser.
4. Enter your product's IP address into the address bar.

You see the available Web Config utility options.

Parent topic: [Changing or Updating Network Connections](#)

Related tasks

[Viewing the Network Status](#)

Changing a USB Connection to a Wi-Fi Connection

If you have already connected your product to your computer using a USB connection, you can change to a Wi-Fi connection.

1. Disconnect the USB cable from your product.
2. Uninstall your product software.

3. Download and install your product software from the Epson website using the instructions on the *Start Here* sheet.

Parent topic: [Changing or Updating Network Connections](#)

Related concepts

[Uninstall Your Product Software](#)

Connecting to a New Wi-Fi Router

If you change the wireless router you have been using on your network, you need to update your product's Wi-Fi connection to the new router.

Note: If you switch to a 5 GHz wireless router, set the router to operate in dual band (2.4 GHz and 5 GHz) mode. See your router documentation for instructions.

1. Do one of the following:
 - **Windows:** Uninstall your product software.
 - **OS X:** Go to the next step.
2. Download and install your product software from the Epson website using the instructions on the *Start Here* sheet.

Parent topic: [Changing or Updating Network Connections](#)

Related concepts

[Uninstall Your Product Software](#)

Disabling Wi-Fi Features

You may need to disable your product's Wi-Fi features if you change your network connection type or need to solve a problem with your network connection.

Note: Before disabling Wi-Fi features, make a note of your product's SSID (network name) and password, and any network settings selected for the Epson Connect services you may use.

1. Press the  home button, if necessary.
2. Press the arrow buttons to select **Setup** and press the **OK** button.
3. Select **Network Settings** and press the **OK** button.

You see this screen:

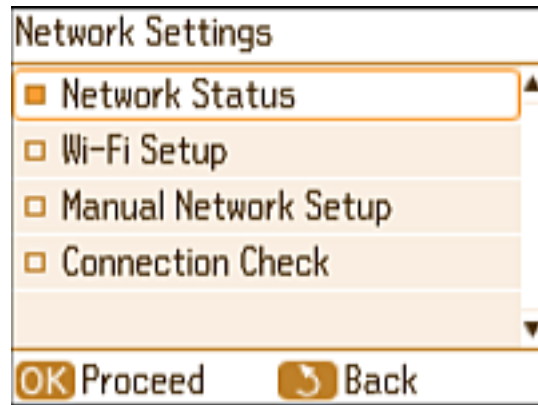

4. Select **Wi-Fi Setup** and press the **OK** button.
5. Select **Disable Wi-Fi** and press the **OK** button.
6. Select **Yes** and press the **OK** button to disable Wi-Fi.

Parent topic: [Changing or Updating Network Connections](#)

Loading Paper

Before you print, load paper for the type of printing you will do.

[Loading Paper in the Paper Feed Slot](#)

[Paper Loading Capacity](#)

[Available Epson Papers](#)

[Borderless Paper Type Compatibility](#)

[Paper or Media Type Settings - Product Software](#)

[Selecting the Paper Source Settings - Control Panel](#)

Loading Paper in the Paper Feed Slot

You can print photos on a variety of paper types and sizes up to: 5 × 7 inches (127 × 178 mm)

1. Slide the edge guide to the right.

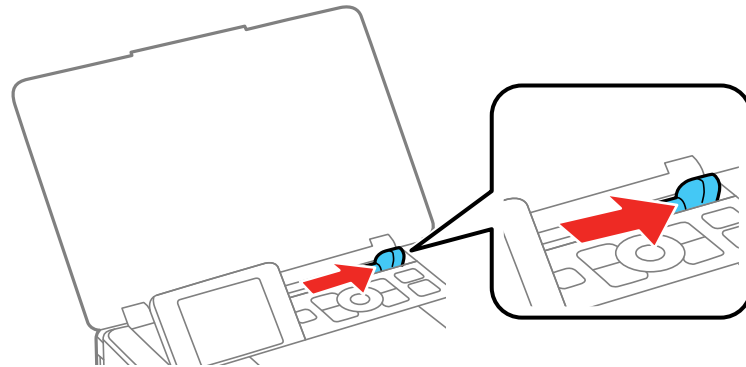

2. Load paper, glossy or printable side up and short edge first, against the left side of the paper feed slot.

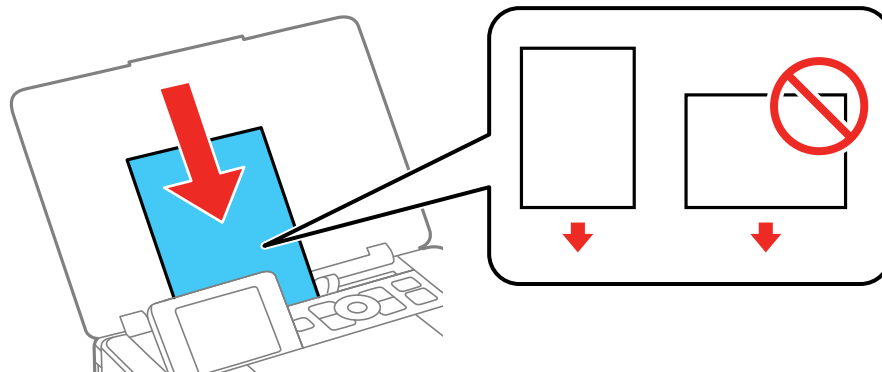

Note: To load envelopes, insert the envelopes printable side up and flap edge left.

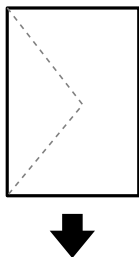

3. Slide the edge guide against the paper, but not too tightly.

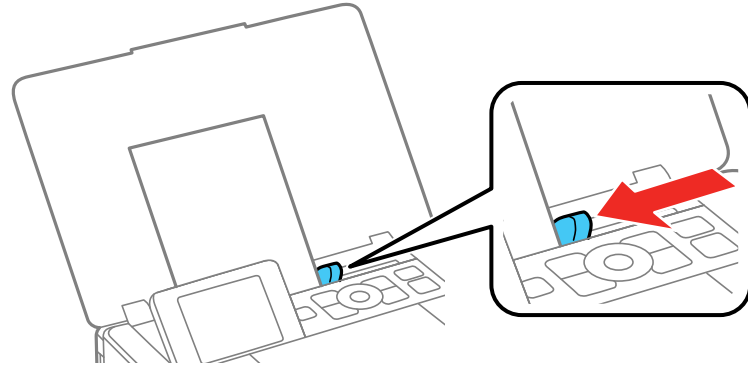

4. If prompted by the product's LCD screen, select the size and type of the paper you loaded.

Always follow these paper loading guidelines:

- Load only the recommended number of sheets.
- Load paper short edge first, no matter which way your document faces.
- Do not load paper above the arrow mark inside the edge guide.
- If you have trouble loading a stack of envelopes, press each envelope flat before loading it or load one envelope at a time.
- Do not load envelopes that are curled, folded, or too thin, or that have plastic windows.
- Check the paper package for any additional loading instructions.

Parent topic: [Loading Paper](#)

Related references

[Paper Loading Capacity](#)

[Paper Specifications](#)

Paper Loading Capacity

Paper type	Paper size	Load up to this many sheets
Plain paper*	A5 (5.8 × 8.2 inches [148 × 210 mm])	Up to the arrow mark on the edge guide
	A6 (4.1 × 5.8 inches [105 × 148 mm])	
Epson Photo Paper Glossy	4 × 6 inches (102 × 152 mm)	20 sheets
	5 × 7 inches (127 × 178 mm)	
Epson Premium Photo Paper Glossy	4 × 6 inches (102 × 152 mm)	20 sheets
	5 × 7 inches (127 × 178 mm)	
Epson Premium Photo Paper Semi-gloss	4 × 6 inches (102 × 152 mm)	20 sheets
Epson Ultra Premium Photo Paper Glossy	4 × 6 inches (102 × 152 mm)	20 sheets
Envelopes	No. 10 (4.1 × 9.5 inches [105 × 241 mm])	10 envelopes

* You can load up to 20 sheets for manual 2-sided print jobs.

Parent topic: [Loading Paper](#)

Available Epson Papers

You can purchase genuine Epson ink and paper at epson.com/ink3 (U.S. sales) or epson.ca (Canadian sales). You can also purchase supplies from an Epson authorized reseller. To find the nearest one, call 800-GO-EPSON (800-463-7766).

Note: Paper/media availability varies by country.

Paper Type	Size	Part number	Sheet count
Print Pack (includes Epson Photo Paper Glossy paper and ink cartridge)	4 × 6 inches (102 × 152 mm)	320P	100

Paper Type	Size	Part number	Sheet count
Epson Photo Paper Glossy	4 × 6 inches (102 × 152 mm)	S041809	50
		S042038	100
Epson Premium Photo Paper Glossy	4 × 6 inches (102 × 152 mm)	S041808	40
	5 × 7 inches (127 × 178 mm)	S041727	100
		S041464	20
Epson Premium Photo Paper Semi-gloss	4 × 6 inches (102 × 152 mm)	S041982	40
Epson Ultra Premium Photo Paper Glossy	4 × 6 inches (102 × 152 mm)	S042181	60
		S042174	100

Parent topic: [Loading Paper](#)

Borderless Paper Type Compatibility

You can print borderless photos on compatible paper types in compatible sizes:

Borderless Paper Types

- Epson Photo Paper Glossy
- Epson Premium Photo Paper Glossy
- Epson Premium Photo Paper Semi-gloss
- Epson Ultra Premium Photo Paper Glossy

Borderless Paper Sizes

- 4 × 6 inches (102 × 152 mm)
- 5 × 7 inches (127 × 178 mm)
- 16:9 wide (4 × 7.1 inches [102 × 181 mm])

Parent topic: [Loading Paper](#)

Paper or Media Type Settings - Product Software

For this paper	Select this Paper Type or Media Type setting
Plain paper	Plain Paper
Epson Ultra Premium Photo Paper Glossy	Ultra Premium Photo Paper Glossy
Epson Premium Photo Paper Glossy	Premium Photo Paper Glossy
Epson Photo Paper Glossy	Photo Paper Glossy
Epson Premium Photo Paper Semi-gloss	Premium Photo Paper Semi-Gloss
Envelope	Envelope

Parent topic: [Loading Paper](#)

Selecting the Paper Source Settings - Control Panel

You can change the default paper settings using the control panel on the product.

1. Press the  home button, if necessary.
2. Press the arrow buttons to select **Setup** > **Printer Setup** > **Paper Source Settings**, pressing the **OK** button after each selection.

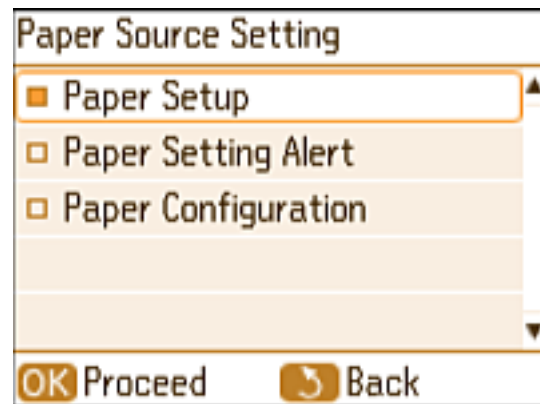

3. Select the following options as necessary:
 - **Paper Setup**: Changes the default paper size and paper type settings

- **Paper Setting Alert:** Controls whether or not an alert appears when a print job's paper settings are different from the product's default paper settings
- **Paper Configuration:** Controls whether or not the paper settings selection screen appears after you load paper.

4. Press the  home button to exit.

[Paper Type Settings - Control Panel](#)

Parent topic: [Loading Paper](#)

Paper Type Settings - Control Panel

For this paper	Select this Paper Type setting
Plain paper	Plain Paper
Epson Ultra Premium Photo Paper Glossy	Ultra Glossy
Epson Premium Photo Paper Glossy	Prem. Glossy
Epson Photo Paper Glossy	Glossy
Epson Premium Photo Paper Semi-gloss	Prem. Semi-Gloss
Envelope	Envelope

Parent topic: [Selecting the Paper Source Settings - Control Panel](#)

Printing from a Computer

Before printing from your computer, make sure you have set up your product and installed its software as described on the *Start Here* sheet.

Note: If you have an Internet connection, it is a good idea to check for updates to your product software on Epson's support website. If you see a Software Update screen, select **Enable automatic checking** and click **OK**. The update scans your system to see if you have the latest product software. Follow the on-screen instructions.

[Printing with Windows](#)

[Printing with OS X](#)

[Cancelling Printing Using a Product Button](#)

Printing with Windows

You can print with your product using any Windows application, as described in these sections.

[Selecting Basic Print Settings - Windows](#)

[Selecting Double-sided Printing Settings - Windows](#)

[Selecting Additional Layout and Print Options - Windows](#)

[Selecting a Printing Preset - Windows](#)

[Selecting Extended Settings - Windows](#)

[Printing Your Document or Photo - Windows](#)

[Selecting Default Print Settings - Windows](#)

[Changing Automatic Update Options](#)

Parent topic: [Printing from a Computer](#)

Selecting Basic Print Settings - Windows

Select the basic settings for the document or photo you want to print.

1. Open a photo or document for printing.
2. Select the print command in your application.

Note: You may need to select a print icon on your screen, the **Print** option in the **File** menu, or another command. See your application's help utility for details.

3. If necessary, select your product name as the printer you want to use.

Note: You may also need to select **Properties** or **Preferences** to view your print settings.

You see the Main tab of your printer settings window:

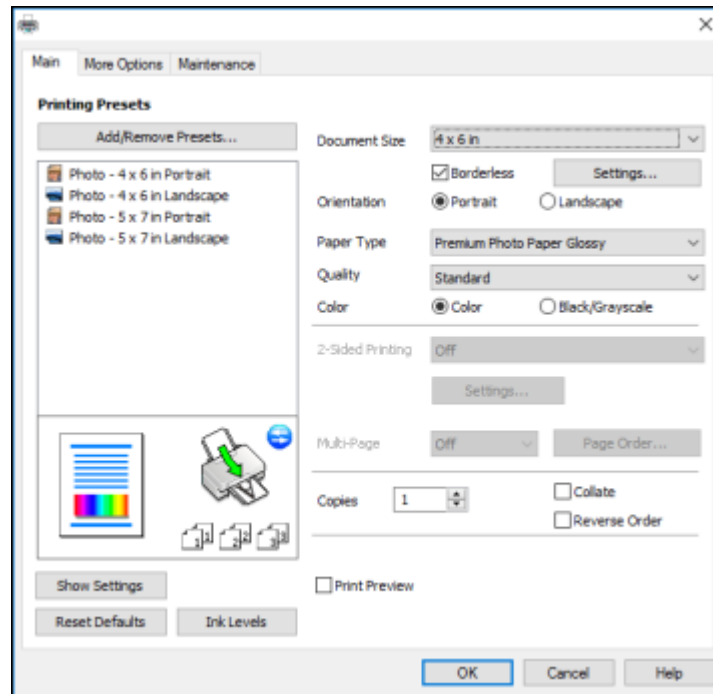

4. Select the size of the paper you loaded as the **Document Size** setting.

Note: You can also select the **User-Defined** setting to create a custom paper size, but you will not be able to use the **Borderless** setting.

5. If you are printing a borderless photo, select **Borderless**. You can click **Settings** to access additional options for borderless printing.

Note: You must select a compatible borderless paper type and size to print without borders. Check the borderless paper compatibility list for details.

6. Select the orientation of your document.

Note: If you are printing an envelope, select **Landscape**.

7. Select the type of paper you loaded as the **Paper Type** setting.

Note: The setting may not exactly match the name of your paper. Check the paper type settings list for details.

8. Select the **Quality** setting that matches the print quality you want to use.

9. Select a Color option:

- To print a color document or photo, select the **Color** setting.
- To print text and graphics in black or shades of gray, select the **Black/Grayscale** setting.

10. To print on both sides of the paper, select a **2-Sided Printing** option.

11. To print multiple pages on one sheet of paper, or print one image on multiple sheets of paper, select one of the settings in the **Multi-Page** menu and select the printing options you want.

12. To print multiple copies and arrange their print order, select the **Copies** options.

13. To preview your job before printing, select **Print Preview**.

[Print Quality Options - Windows](#)

[Multi-Page Printing Options - Windows](#)

Parent topic: [Printing with Windows](#)

Related references

[Borderless Paper Type Compatibility](#)

[Paper or Media Type Settings - Product Software](#)

Related tasks

[Selecting Double-sided Printing Settings - Windows](#)

[Printing Your Document or Photo - OS X](#)

Print Quality Options - Windows

You can select any of the available Quality options to fine-tune the quality of your print. Some settings may be unavailable, depending on the paper type setting you have chosen.

Standard

For everyday text and image printing.

High

For text and graphics with high print quality.

Parent topic: [Selecting Basic Print Settings - Windows](#)

Multi-Page Printing Options - Windows

You can select any of the available options in the Multi-Page menu to set up your multi-page print job.

2-Up and 4-Up

Prints 2 or 4 pages on one sheet of paper. Click the **Page Order** button to select page layout and border options.

2×1 Poster, 2×2 Poster, 3×3 Poster, 4×4 Poster

Prints one image on multiple sheets of paper to create a larger poster. Click the **Settings** button to select image layout and guideline options.

Parent topic: [Selecting Basic Print Settings - Windows](#)

Selecting Double-sided Printing Settings - Windows

You can print on both sides of the paper by selecting one of the **2-Sided Printing** options on the Main tab.

Note: You will need to print one side and flip the paper over manually to print the other side.

Note: Some options may be pre-selected or unavailable, depending on other settings you have chosen or if you are accessing the product over a network.

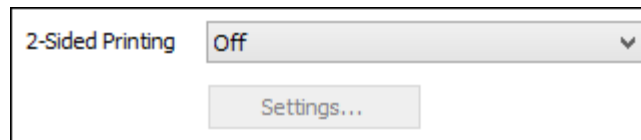

1. Select one of the following options for **2-Sided Printing**:
 - **Manual (Long-edge binding)** to print your double-sided print job by printing one side and prompting you to flip the paper over on the long edge to print the other side.
 - **Manual (Short-edge binding)** to print your double-sided print job by printing one side and prompting you to flip the paper over on the short edge to print the other side.
2. Click the **Settings** button.

You see a window like this:

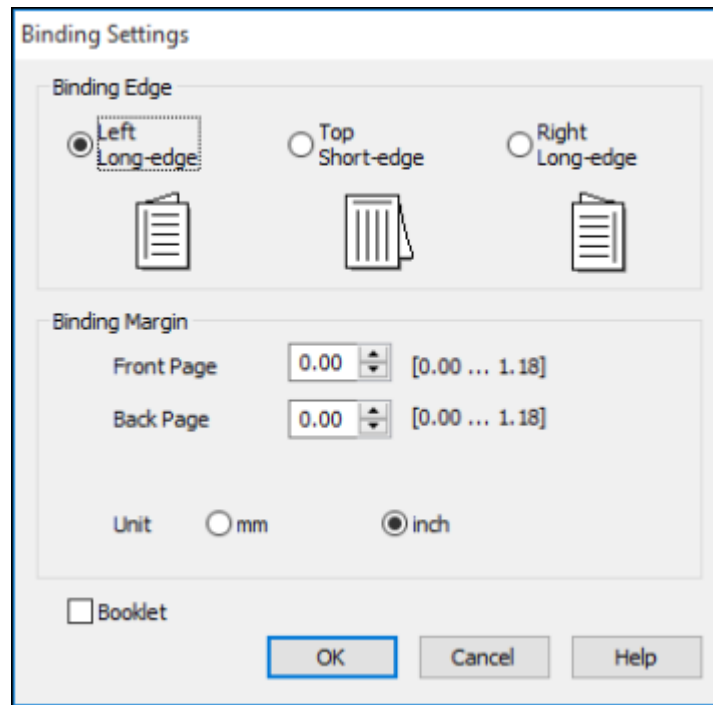

3. Select the double-sided printing options you want to use.
4. Click **OK** to return to the Main tab.
5. Print a test copy of your double-sided document to test the selected settings.
6. Follow any instructions displayed on the screen during printing.

Note: The surface of the paper may smear during double-sided printing. Make sure the ink has dried before reloading the paper.

[Double-sided Printing Options - Windows](#)

Parent topic: [Printing with Windows](#)

Related tasks

[Selecting Basic Print Settings - Windows](#)

Double-sided Printing Options - Windows

You can select any of the available options on the 2-Sided Printing Settings window to set up your double-sided print job.

Binding Edge Options

Select a setting that orients double-sided print binding in the desired direction.

Binding Margin Options

Select options that define a wider margin to allow for binding.

Booklet

Select the **Booklet** checkbox to print double-sided pages as a booklet.

Parent topic: [Selecting Double-sided Printing Settings - Windows](#)

Selecting Additional Layout and Print Options - Windows

You can select a variety of additional layout and printing options for your document or photo on the More Options tab.

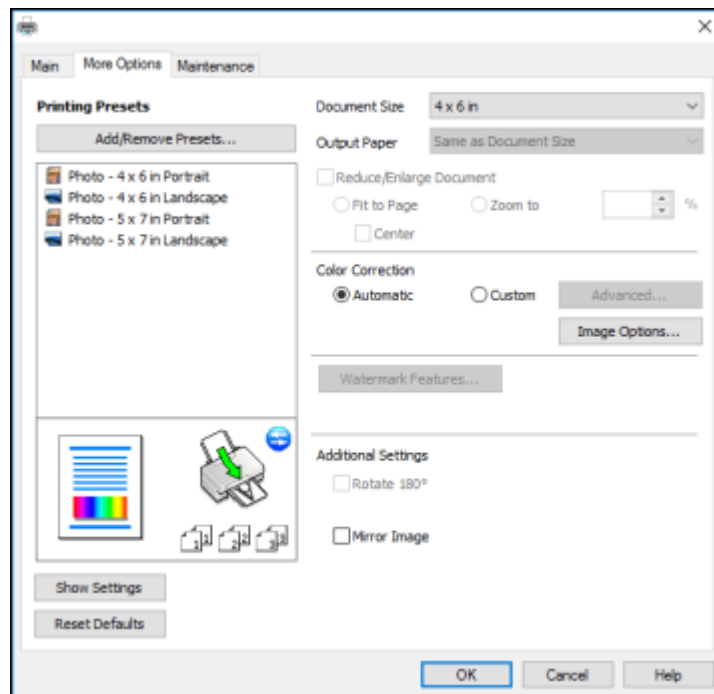

1. To change the size of your printed document or photo, select the **Reduce/Enlarge Document** checkbox and select one of these sizing options:
 - Select the **Fit to Page** option to size your image to fit the paper you loaded. Select the size of the your document or photo as the **Document Size** setting, and the size of your paper as the **Output Paper** setting. If you want to center your image on the paper, select the **Center** option.
 - Select the **Zoom to** option to reduce or enlarge your document or photo by a specific percentage. Select the percentage in the % menu.
2. Select one of the following Color Correction options:
 - Select **Automatic** to automatically adjust the sharpness, brightness, contrast, and color saturation for your image.
 - Select **Custom** and click the **Advanced** button to manually adjust the color correction settings or turn off color management in your printer software.
 - Select **Image Options** to access additional settings for improving printed images.
3. To add the following features, click the **Watermark Features** button:
 - **Watermark**: adds a visible watermark to your printout.

Note: Click the **Add/Delete** button to create your own watermark, and click the **Settings** button to customize the watermark.
 - **Header/Footer**: adds information such as the date and time to the top or bottom of your printout.

Note: Click the **Settings** button to customize the text and location of the header or footer.
4. Select any of the Additional Settings options to customize your print.

[Custom Color Correction Options - Windows](#)

[Image Options and Additional Settings - Windows](#)

Parent topic: [Printing with Windows](#)

Custom Color Correction Options - Windows

You can select any of the available options in the Color Correction window to customize the image colors for your print job.

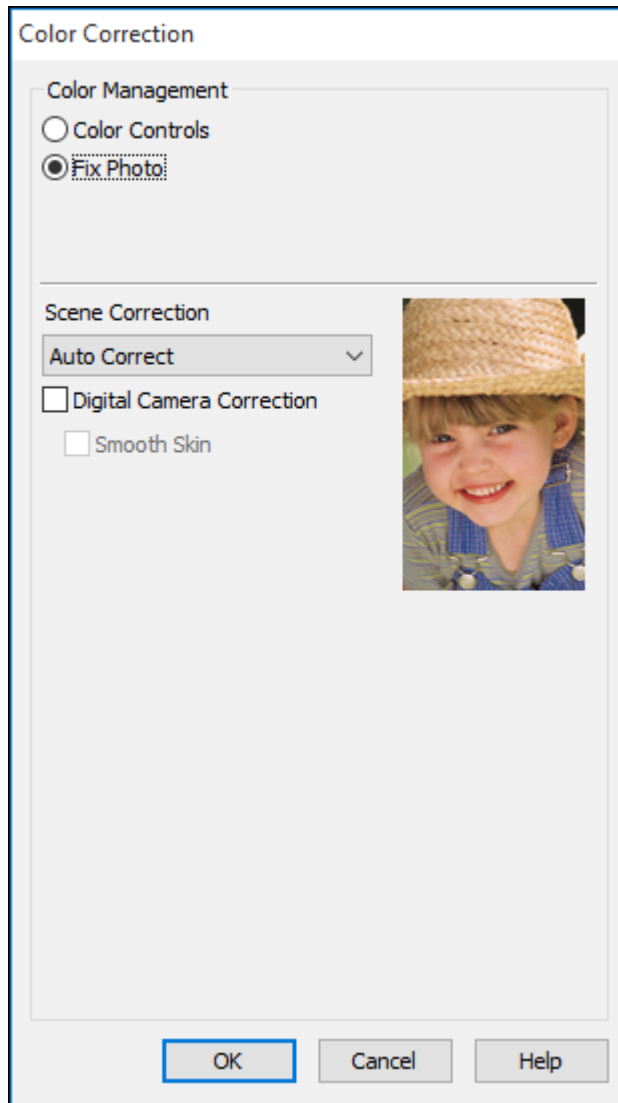

Color Controls

Lets you select a **Color Mode** setting, individual settings for **Brightness**, **Contrast**, **Saturation**, and **Density**, and individual color tones. Depending on the selected color mode, you can also adjust the midtone density using the **Gamma** setting.

Fix Photo

Improves the color, contrast, and sharpness of flawed photos.

Note: Fix Photo uses a sophisticated face recognition technology to optimize photos that include faces. For this to work, both eyes and the nose must be visible in the subject's face. If your photo includes a face with an intentional color cast, such as a statue, you may want to turn off **Fix Photo** to retain the special color effects.

Parent topic: [Selecting Additional Layout and Print Options - Windows](#)

Image Options and Additional Settings - Windows

You can select any of the Image Options and Additional Settings to customize your print. Some options may be pre-selected or unavailable, depending on other settings you have chosen.

Image Options

Emphasize Text

Adjusts the weight of printed text to increase readability.

Emphasize Thin Lines

Adjusts the weight of printed lines to increase visibility.

Edge Smoothing

Smooths jagged edges in low-resolution images such as screen captures or images from the Web.

Fix Red-Eye

Reduces or removes red-eye in photos.

Additional Settings Options

Rotate 180°

Prints the image rotated 180° from its original orientation.

Mirror Image

Flips the printed image left to right.

Parent topic: [Selecting Additional Layout and Print Options - Windows](#)

Selecting a Printing Preset - Windows

For quick access to common groups of print settings, you can select a printing preset on the Main or More Options tab.

Note: You can create your own preset by clicking the **Add/Remove Presets** button.

1. Click the **Main** or **More Options** tab.

You see the available **Printing Presets** on the left:

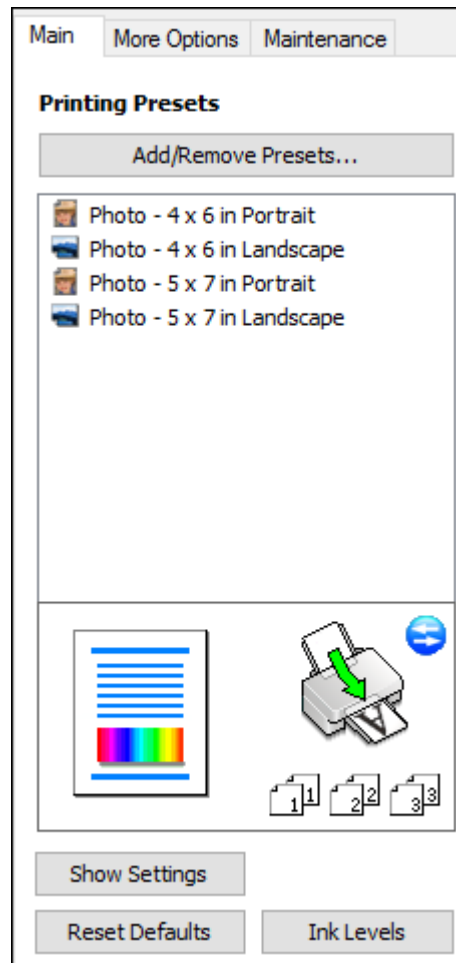

2. Place your cursor over one of the **Printing Presets** to view its list of settings.
3. Click on a preset to change its settings, or use any of the available options on the screen to control your printing presets.
4. To choose a preset for printing, select it.
5. Click **OK**.

Parent topic: [Printing with Windows](#)

Selecting Extended Settings - Windows

You can select additional settings that apply to all the print jobs you send to your product.

1. Access the Windows Desktop and right-click the product icon in the Windows taskbar.
2. Select **Printer Settings**.
3. Click the **Maintenance** tab.

You see the maintenance options:

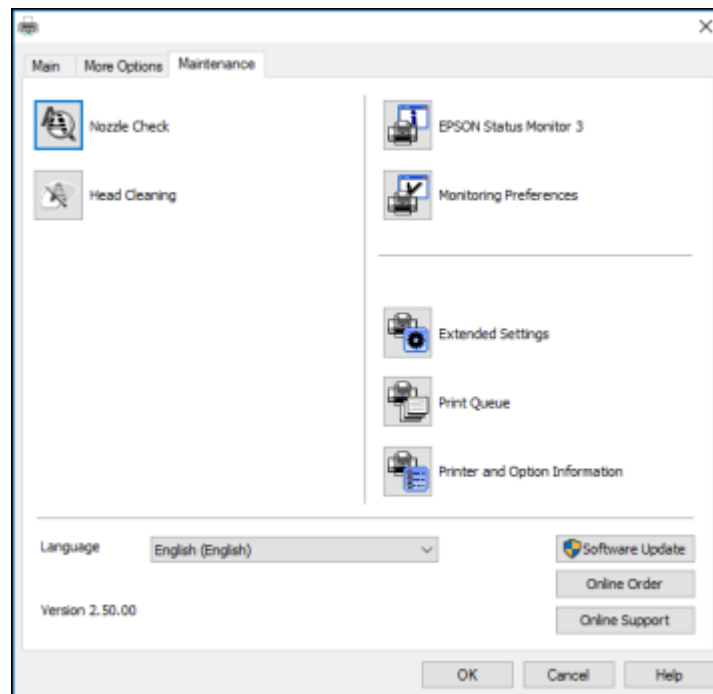

4. Click the **Extended Settings** button.

You see this window:

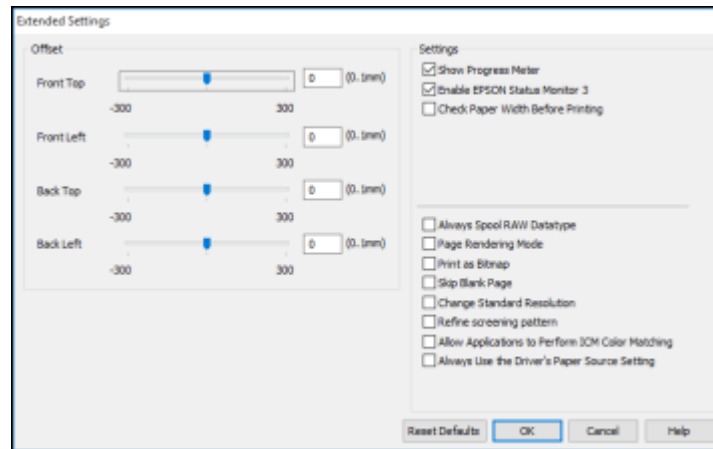

5. Select any of the extended settings to customize your print.
6. Click **OK** to close the Extended Settings window.
7. Click **OK** to close the printer software window.

[Extended Settings - Windows](#)

Parent topic: [Printing with Windows](#)

Extended Settings - Windows

You can select from these settings on the Extended Settings window.

Show Progress Meter

Displays the progress of print jobs as they are being printed.

Enable EPSON Status Monitor 3

Enables product monitoring for ink and paper supplies and other issues.

Check Paper Width Before Printing

Prevents printing beyond the edges of the paper if the paper size setting is incorrect; may reduce print speed.

Always Spool RAW Datatype

Increases print speed and may solve other printing problems.

Page Rendering Mode

Increases print speed when printing is extremely slow or the print head stops during printing.

Print as Bitmap

Increases print speed when printing is extremely slow or the print head stops during printing, and other settings do not help.

Skip Blank Page

Ensures that your product does not print pages that contain no text or images.

Change Standard Resolution

Reduces the resolution of print data to correct printing problems.

Refine screening pattern

Prints graphics with a finer screening pattern.

Allow Applications to Perform ICM Color Matching

Allows applications to perform ICM color matching.

Always Use the Driver's Paper Source Setting

Prints using the paper source setting in the printer driver, rather than the setting in your application.

Parent topic: [Selecting Extended Settings - Windows](#)

Printing Your Document or Photo - Windows

Once you have selected your print settings, you are ready to save your settings and print.

1. Click **OK** to save your settings.

You see your application's Print window, such as this one:

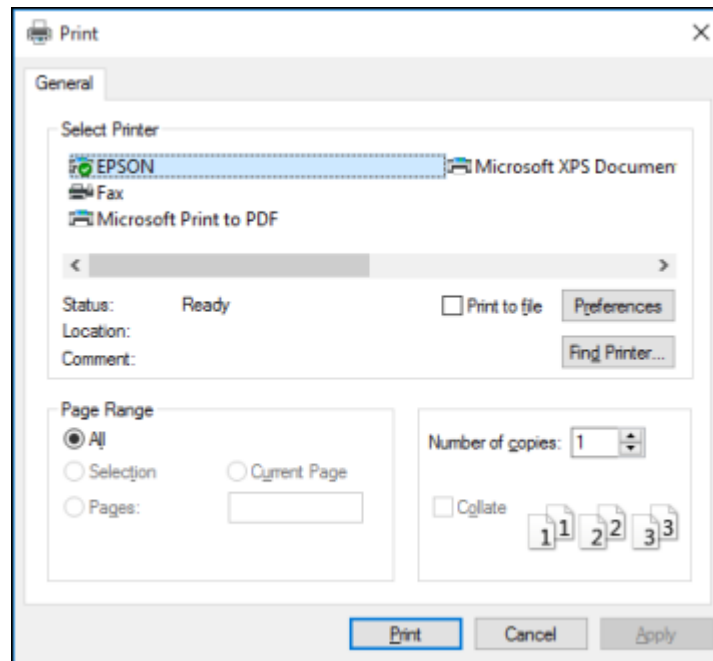

2. Click **OK** or **Print** to start printing.

[Checking Print Status - Windows](#)

Parent topic: [Printing with Windows](#)

Checking Print Status - Windows

During printing, you see this window showing the progress of your print job. It allows you to control printing and check ink cartridge status.

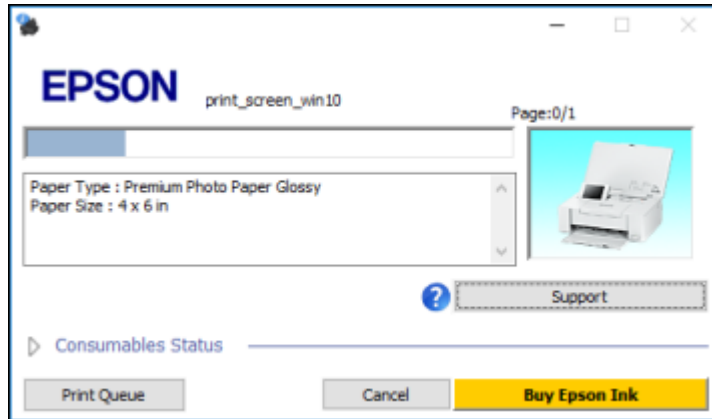

- To cancel printing, click **Cancel**.
- To see print jobs waiting to print, click **Print Queue**.
- To check ink status, click **Consumables Status**.

Parent topic: [Printing Your Document or Photo - Windows](#)

Selecting Default Print Settings - Windows

When you change your print settings in a program, the changes apply only while you are printing in that program session. If you want to change the print settings you use in all your Windows programs, you can select new default print settings.

1. Access the Windows Desktop and right-click the product icon in the Windows taskbar.
2. Select **Printer Settings**.

You see the printer settings window:

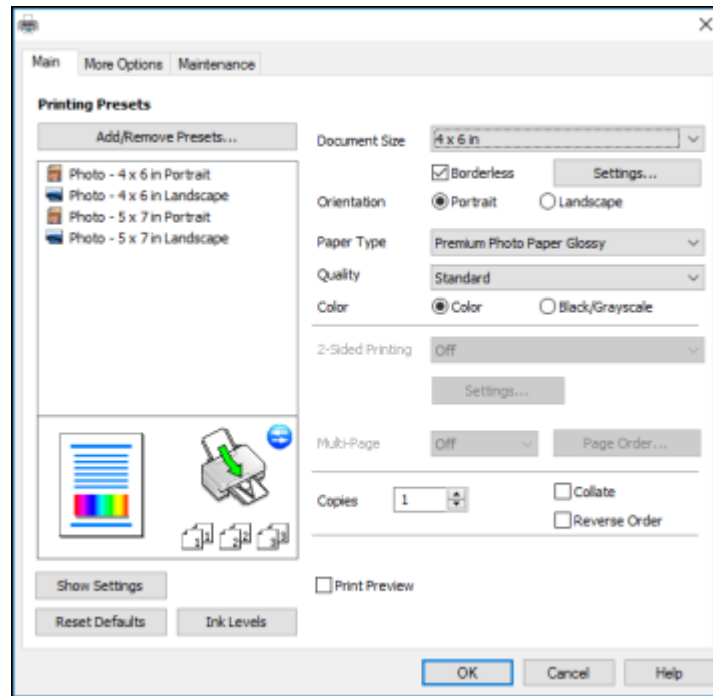

3. Select the print settings you want to use as defaults in all your Windows programs.
4. Click **OK**.

These settings are now the defaults selected for printing. You can still change them as needed for printing in any program session.

[Changing the Language of the Printer Software Screens](#)

Parent topic: [Printing with Windows](#)

Changing the Language of the Printer Software Screens

You can change the language used on the Windows printer software screens.

1. Access the Windows Desktop and right-click the product icon in the Windows taskbar.
2. Select **Printer Settings**.

You see the printer settings window.

3. Click the **Maintenance** tab.
You see the maintenance options:

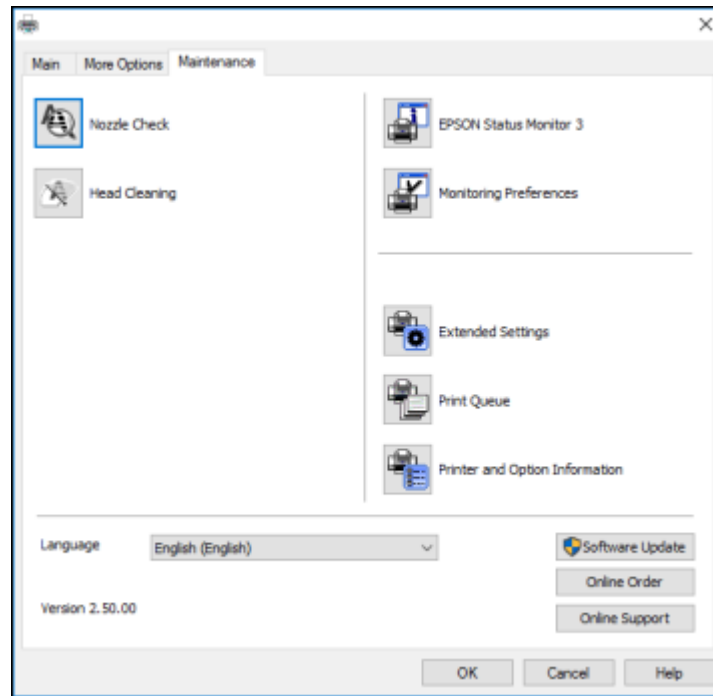

4. Select the language you want to use as the **Language** setting.
5. Click **OK** to close the printer software window.

The printer software screens appear in the language you selected the next time you access them.

Parent topic: [Selecting Default Print Settings - Windows](#)

Changing Automatic Update Options

Your printer software for Windows automatically checks for updates to the product software. You can change how often the software checks for updates or disable this feature.

1. Access the Windows Desktop and right-click the product icon in the Windows taskbar.
2. Select **Software Update Settings**.

You see this window:

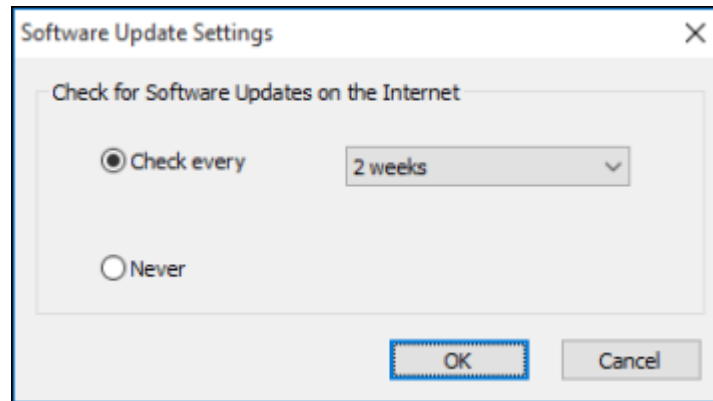

3. Do one of the following:
 - To change how often the software checks for updates, select a setting in the **Check every** menu.
 - To disable the automatic update feature, select the **Never** option.
4. Click **OK** to exit.

Note: If you choose to disable the automatic update feature, you can check for updates manually.

Parent topic: [Printing with Windows](#)

Related tasks

[Checking for Software Updates](#)

Printing with OS X

You can print with your product using any OS X printing program, as described in these sections.

Note: If you have an Internet connection, it is a good idea to check for updates to your product software on Epson's support website.

[Selecting Basic Print Settings - OS X](#)

[Selecting Page Setup Settings - OS X](#)

[Selecting Print Layout Options - OS X](#)

[Sizing Printed Images - OS X](#)

[Managing Color - OS X](#)

[Selecting Printing Preferences - OS X](#)

[Printing Your Document or Photo - OS X](#)

Parent topic: [Printing from a Computer](#)

Selecting Basic Print Settings - OS X

Select the basic settings for the document or photo you want to print.

1. Open a photo or document for printing.
2. Select the print command in your application.

Note: You may need to select a print icon on your screen, the **Print** option in the File menu, or another command. See your application's help utility for details.

3. Select your product as the **Printer** setting.

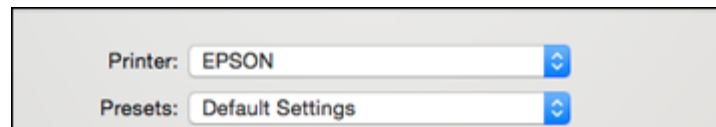

4. If necessary, click the arrow next to the Printer setting or the **Show Details** button to expand the print window.

You see the expanded printer settings window for your product:

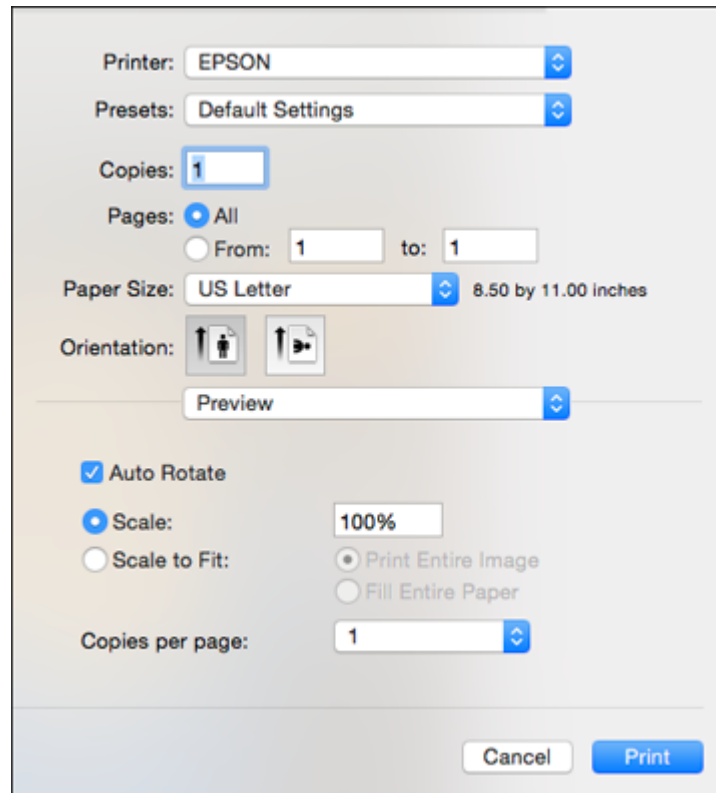

Note: The print window may look different, depending on the version of OS X and the application you are using.

5. Select the **Copies** and **Pages** settings as necessary.

Note: If you do not see these settings in the print window, check for them in your application before printing.

6. Select the page setup options: **Paper Size** and **Orientation**.

Note: If you do not see these settings in the print window, check for them in your application before printing. They may be accessible by selecting **Page Setup** from the File menu.

7. Select any application-specific settings that appear on the screen, such as those shown in the image above for the Preview application.
8. Select **Print Settings** from the pop-up menu.

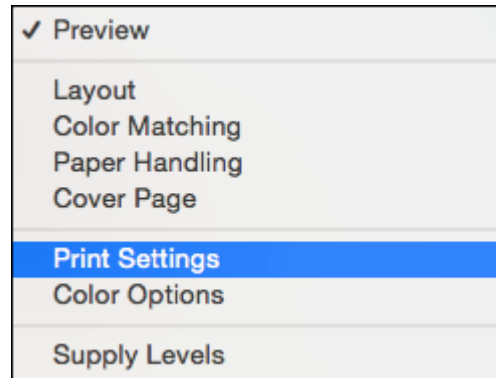

You see these settings:

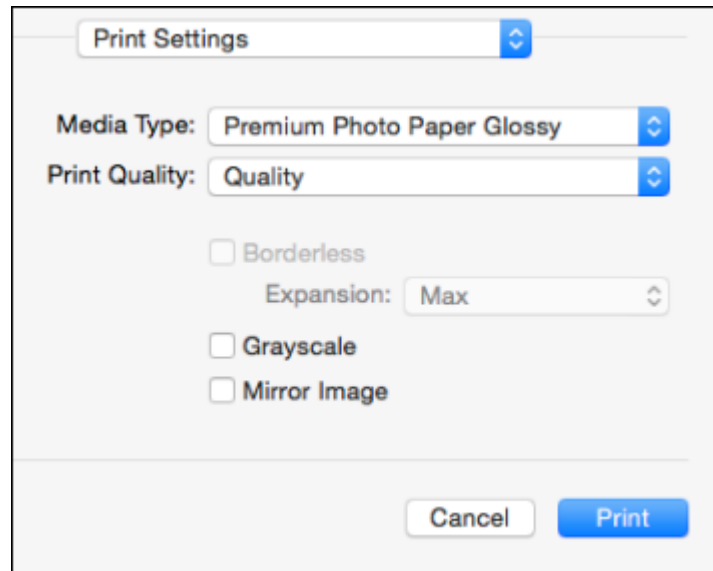

9. Select the type of paper you loaded as the **Media Type** setting.

Note: The setting may not exactly match the name of your paper. Check the paper type settings list for details.

10. Select the **Print Quality** setting you want to use.
11. Select any of the available print options.

[Print Quality Settings - OS X](#)

[Print Options - OS X](#)

Parent topic: [Printing with OS X](#)

Related references

[Paper or Media Type Settings - Product Software](#)

Related tasks

[Selecting Page Setup Settings - OS X](#)

[Printing Your Document or Photo - OS X](#)

Print Quality Settings - OS X

You can select any of the print quality settings to fine-tune the quality of your print. Some settings may be unavailable, depending on the paper type and border setting you have chosen.

Normal

For everyday text and image printing.

Fine

For text and graphics with good quality and print speed.

Quality

For photos and graphics with good quality and print speed.

Best Quality

For the best print quality, but the slowest print speed.

Parent topic: [Selecting Basic Print Settings - OS X](#)

Print Options - OS X

You can select any of the print options to customize your print. Some options may be unavailable, depending on other settings you have chosen.

Expansion

If you selected a borderless paper size setting, this option adjusts the image expansion settings to control printing at the edges of borderless prints.

Grayscale

Prints text and graphics in black or shades of gray.

Mirror Image

Lets you flip the printed image horizontally.

Note: If you select the **Min** option for the Expansion setting, you may see white borders on your printed photo.

Parent topic: [Selecting Basic Print Settings - OS X](#)

Selecting Page Setup Settings - OS X

Depending on your application, you may be able to select the paper size and orientation settings from the print window.

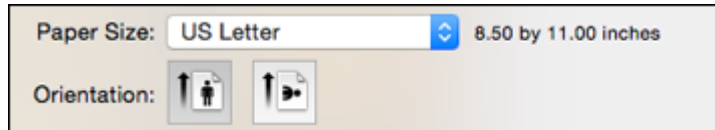

Note: If you do not see these settings in the print window, check for them in your application before printing. They may be accessible by selecting **Page Setup** from the File menu.

1. Select the size of the paper you loaded as the **Paper Size** setting. If you are printing a borderless photo, select the **Borderless** checkbox or a paper size with a **Borderless** option. You can also select a custom setting to create a custom paper size, but the Quality setting will be limited to **Normal**.

Note: You must select a compatible borderless paper type and size to print without borders. Check the borderless paper compatibility list for details.

2. Select the orientation of your document or photo as shown in the print window.

Note: If you are printing an envelope, select the  icon.

Note: You can reduce or enlarge the size of the printed image by selecting **Paper Handling** from the pop-up menu and selecting a scaling option.

Parent topic: [Printing with OS X](#)

Related references

[Borderless Paper Type Compatibility](#)

Selecting Print Layout Options - OS X

You can select a variety of layout options for your document or photo by selecting **Layout** from the pop-up menu on the print window.

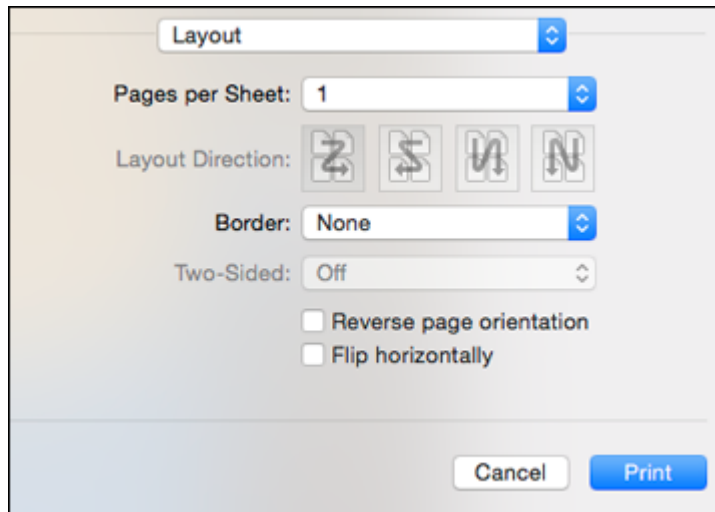

- To print multiple pages on one sheet of paper, select the number of pages in the **Pages per Sheet** pop-up menu. To arrange the print order of the pages, select a **Layout Direction** setting.
- To print borders around each page on the sheet, select a line setting from the **Border** pop-up menu.
- To invert or flip the printed image, select the **Reverse page orientation** or **Flip horizontally** settings.

Parent topic: [Printing with OS X](#)

Sizing Printed Images - OS X

You can adjust print order and the size of the image as you print it by selecting **Paper Handling** from the pop-up menu on the Print window.

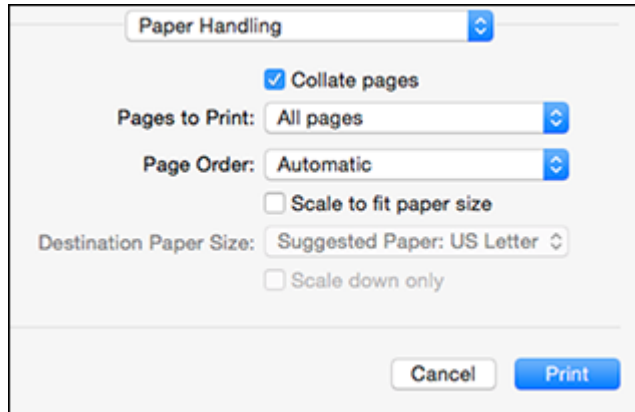

- To print only selected pages in a multi-page document, select an option from the **Pages to Print** pop-up menu.
- To adjust the order in which pages are printed, select an option from the **Page Order** pop-up menu.
- To scale the image to fit on a specific paper size, select the **Scale to fit paper size** checkbox and select a paper size from the **Destination Paper Size** pop-up menu.

Parent topic: [Printing with OS X](#)

Managing Color - OS X

You can adjust the Color Matching and Color Options settings to fine-tune the colors in your printout, or turn off color management in your printer software.

1. Select **Color Matching** from the pop-up menu in the print window.

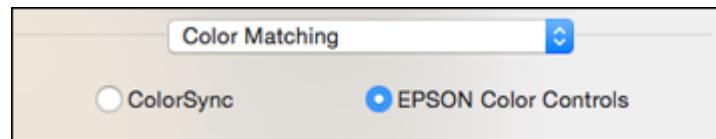

2. Select one of the available options.
3. Select **Color Options** from the pop-up menu in the print window.

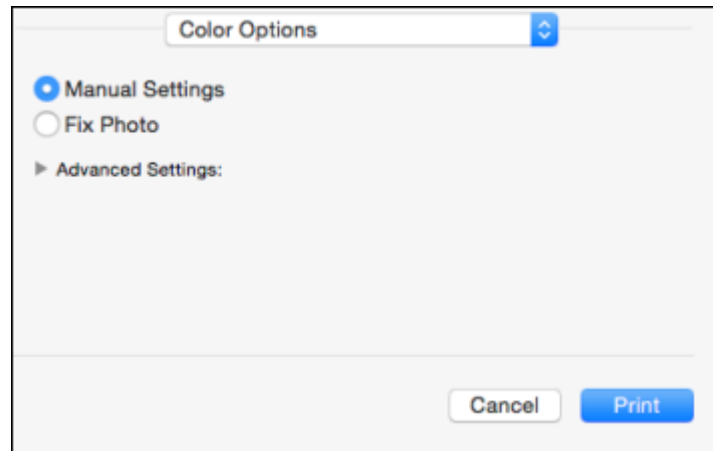

Note: The available settings on the Color Options menu depend on the option you selected on the Color Matching menu.

4. Select one of the available options.

[Color Matching and Color Options - OS X](#)

Parent topic: [Printing with OS X](#)

Color Matching and Color Options - OS X

You can select from these settings on the **Color Matching** and **Color Options** menus.

Color Matching Settings

EPSON Color Controls

Lets you manage color using controls in your printer software or turn off color management.

ColorSync

Prints using standard color profiles for your product and paper to help match image colors. You can customize the conversion method and filter settings on the ColorSync pop-up menu in the print window.

Color Options Settings

Manual Settings

Lets you select manual color adjustments. Click the arrow next to **Advanced Settings** and select settings for **Brightness**, **Contrast**, **Saturation**, and individual color tones. You can also select a color **Mode** setting for printing photos and graphics and the **Fix Red-Eye** setting to reduce or remove red-eye in photos. Depending on the selected color mode, you can also adjust the midtone density using the **Gamma** setting.

Fix Photo

Improves the color, contrast, and sharpness of flawed photos. Click the arrow next to **Advanced Settings** and select the **Fix Red-Eye** setting to reduce or remove red-eye in photos.

Note: Fix Photo uses a sophisticated face recognition technology to optimize photos that include faces. For this to work, both eyes and the nose must be visible in the subject's face. If your photo includes a face with an intentional color cast, such as a statue, you may want to turn off **Fix Photo** to retain the special color effects.

Parent topic: [Managing Color - OS X](#)

Selecting Printing Preferences - OS X

You can select printing preferences that apply to all the print jobs you send to your product.

1. In the Apple menu or the Dock, select **System Preferences**.
2. Select **Print & Fax**, **Print & Scan**, or **Printers & Scanners**, select your product, and select **Options & Supplies**.
3. Select **Driver** or **Options**.

You see a screen like this:

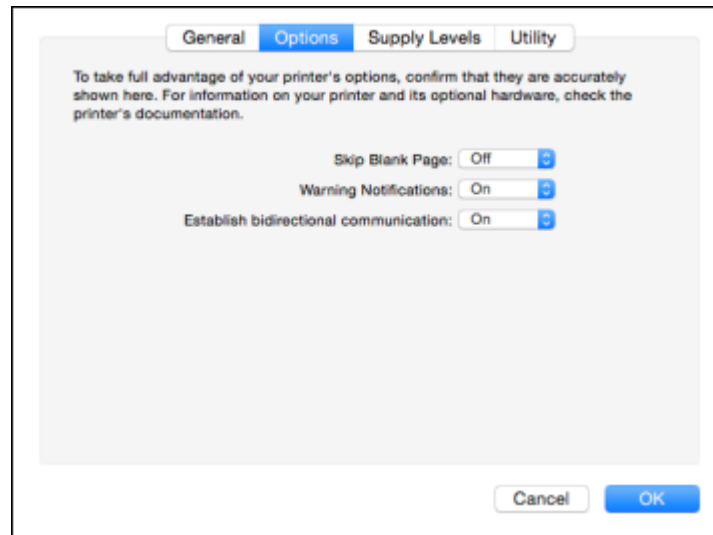

4. Select any of the available printing preferences.
5. Click **OK**.

[Printing Preferences - OS X](#)

Parent topic: [Printing with OS X](#)

Printing Preferences - OS X

You can select from these settings on the **Options** or **Driver** tab.

Skip Blank Page

Ensures that your product does not print pages that contain no text or images.

Warning Notifications

Lets you choose whether or not to receive warning notifications from the printer software for various operating conditions.

Establish bidirectional communication

Allows the product to communicate with the computer. Do not change the default setting unless you experience issues when using a shared printing pool.

Parent topic: [Selecting Printing Preferences - OS X](#)

Printing Your Document or Photo - OS X

Once you have selected your print settings, you are ready to print.
Click **Print** at the bottom of the print window.

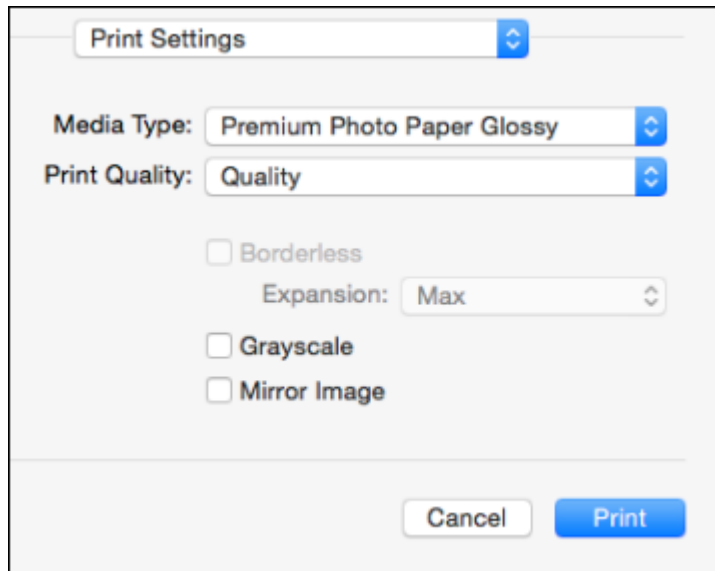

[Checking Print Status - OS X](#)

Parent topic: [Printing with OS X](#)

Checking Print Status - OS X



During printing, you can view the progress of your print job, control printing, and check ink status.

1. Click the printer icon when it appears in the Dock.

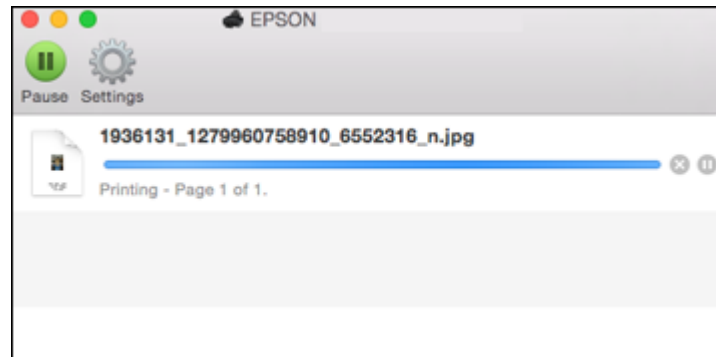
You see the print status window:



2. Select the following options as necessary for your version of OS X:

- To cancel printing, click the print job and click  or **Delete**.
- To pause a print job, click the print job and click  or **Hold**. To resume a print job, click the paused print job and click  or **Resume**.
- To pause printing for all queued print jobs, click **Pause** or **Pause Printer**.
- To display other printer information, click **Settings** or **Supply Levels**.

Parent topic: [Printing Your Document or Photo - OS X](#)

Cancelling Printing Using a Product Button

If you need to cancel printing, press the  stop button your product.

Parent topic: [Printing from a Computer](#)

Using Memory Cards With Your Product

Follow the instructions here to work with a memory card inserted into your product.

[Inserting a Memory Card](#)

[Printing from a Memory Card](#)

[Transferring Photos on a Memory Card](#)

Inserting a Memory Card

Insert only one memory card at a time into a memory card slot on your product.

1. Make sure the memory card and the files on it are compatible with your product before inserting the card.
2. Remove the cap covering the memory card slot, if necessary.
3. Insert your memory card into the correct slot, making sure the card is oriented correctly.

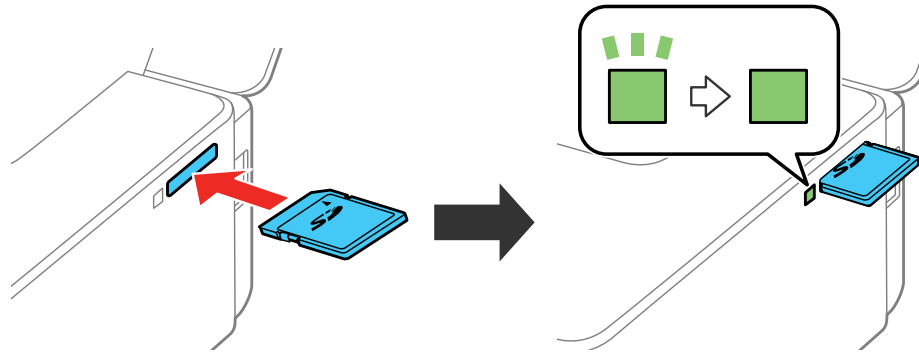

Note: Do not force the card all the way into the slot. Insert it only until it meets resistance.

The memory card access light flashes and then stays lit.

Caution: Do not remove a memory card or turn off your product while the memory card access light is flashing or you may lose data from the memory card.

[Memory Card Types](#)

[Memory Card File Specifications](#)

[Removing a Memory Card](#)

Parent topic: [Using Memory Cards With Your Product](#)

Memory Card Types

You can insert these types of memory cards in your product.

Note: Cards marked with an asterisk (*) require an adapter; consult your adapter documentation for details on using it.

You can insert the following cards in the memory card slot:

- SD
- SDHC
- SDXC
- miniSD*
- miniSDHC*
- microSD*
- microSDHC*
- microSDXC*

Parent topic: [Inserting a Memory Card](#)

Memory Card File Specifications

You can insert memory cards in your product containing files that meet these specifications.

File format	JPEG with the Exif version 2.3 standard taken with digital camera using DCF (Design rule for Camera File system) version 1.0 or 2.0 compliant
Image size	80 × 80 pixels to 10200 × 10200 pixels
File size	Up to 2GB
Number of files	Up to 9990

Parent topic: [Inserting a Memory Card](#)

Removing a Memory Card

After you finish working with a memory card, check to make sure it is safe to remove it from your product.

Caution: Do not remove a memory card or turn off your product while the memory card access light is flashing or you may lose data from the memory card.

1. Make sure the memory card access light is not flashing.

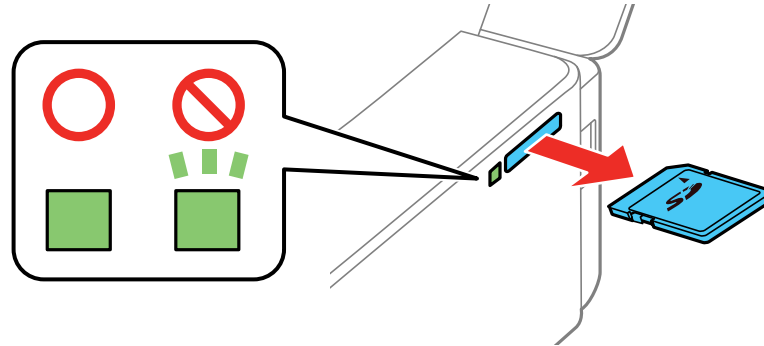

2. Pull the memory card straight out of its slot.

Parent topic: [Inserting a Memory Card](#)

Printing from a Memory Card

See these sections to print photos from a memory card inserted into your product:

[Viewing and Printing Photos](#)

[Printing Photo Layouts](#)

[Print Setting Options](#)

[Photo Adjustment Options](#)

Parent topic: [Using Memory Cards With Your Product](#)

Viewing and Printing Photos

You can select photos for printing as you view them on the LCD screen.

1. Press the  home button, if necessary.

2. Press the arrow buttons to select **Print Photos** and press the **OK** button.
3. Select **View and Print Photos** and press the **OK** button.

A photo on your memory card is displayed:



4. Press the right or left arrow button to scroll through your photos and display one that you want to print.
5. Press the + or – button to select one or more copies of the photo (up to 99).
6. To select additional photos for printing, repeat the steps above.
7. To view additional settings, press the down arrow button.

You see this screen:

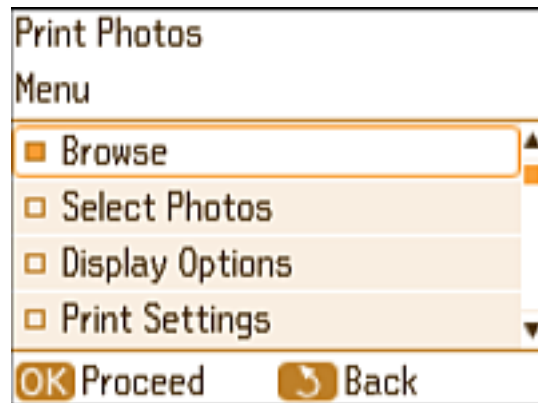

8. Select from the following options:
 - **Browse** to select photos by date
 - **Select Photos** to select all photos
 - **Display Options** to select how photos are displayed on the LCD screen
 - **Print Settings** to change the print settings
 - **Photo Adjustments** to change the appearance of your printed photos
 - **Filter** to apply a sepia tone or black-and-white filter to the viewed or printed photo
 - **Crop/Zoom** to crop or zoom into your photo

Note: When you are finished changing your settings, press the ↩ back button.

9. When you are ready to print, press the ⬄ start button.

Note: To cancel printing, press the ⏹ stop button.

Parent topic: [Printing from a Memory Card](#)

Related references

[Print Setting Options](#)

[Photo Adjustment Options](#)

Printing Photo Layouts

You can print one or more photos from a memory card in special layouts.

1. Press the 🏠 home button, if necessary.
2. Press the arrow buttons to select **Print Photos** and press the **OK** button.
3. Select **Photo Layout Sheet** and press the **OK** button.

You see this screen:

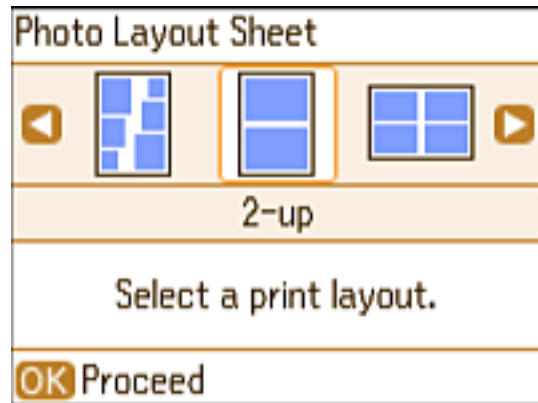

4. Select one of the layout options and press the **OK** button.
5. Select the paper size setting that matches the paper you loaded and press the **OK** button.
6. Select the paper type setting that matches the paper you loaded and press the **OK** button.
7. If you see the screen below, do one of the following:

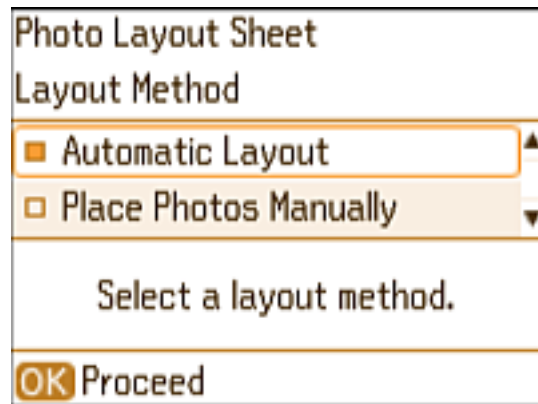

- To allow your product to place photos in the layout automatically, select **Automatic Layout** and press the **OK** button. Press the left or right arrow button to scroll through your photos, and press

the **+** or **-** button to select a photo for your layout. Press the down arrow button to view additional settings. Press the **OK** button when you're finished.

- To place photos in the layout manually, select **Place Photos Manually** and press the **OK** button. Follow the instructions on the LCD screen to select and place photos on your layout sheet.

You see this screen:

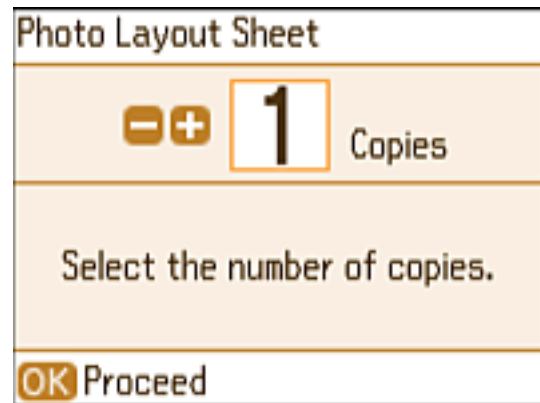

8. Press the **+** or **-** button to select the number of copies (up to 99) and press the **OK** button.
9. When you are ready to print, press the \diamond start button.

Note: To cancel printing, press the \odot stop button.

[Photo Layout Options](#)

Parent topic: [Printing from a Memory Card](#)

Related references

[Paper Type Settings - Control Panel](#)

Photo Layout Options

Select the layout you want to use when printing your photos in a layout.

2-up, 4-up, 8-up, or 20-up

Print 2, 4, 8, or 20 photos on one sheet.

Upper $\frac{1}{2}$ or Lower $\frac{1}{2}$

Print one photo in the upper or lower half of the sheet.

Photo ID

Print 4 ID-sized photos on one sheet.

P.I.F.

This option is displayed if a P.I.F. frame is on your memory card.

Parent topic: [Printing Photo Layouts](#)

Print Setting Options

Select the **Print Settings** options you want to use when printing photos from a memory card or external device.

Print settings	Available options	Description
Paper Size	Various paper sizes	Indicates the size of paper you have loaded
Paper Type	Various paper types	Indicates the type of paper you have loaded; see the list of control panel paper types (available options depend on the selected Paper Size setting)
Borderless	Borderless	Expands the image to the edge of the paper (slight cropping may occur)
	With Border	Leaves a small margin around the image
Quality	Standard	Provides good quality for most prints
	Best	Provides the highest quality for important prints
Expansion	Standard	Expands images correctly for most borderless prints
	Medium	Expands images slightly less for borderless prints
	Minimum	Expands images the least for borderless prints (you may see some white border)
Date	Various date formats	Prints the date you took the photo in the format you select
Fit Frame	On	Automatically crops the photo to fit into the selected photo layout
	Off	Turns off automatic cropping

Note: To return to default print settings, press the  stop button, select **Yes**, and press the **OK** button.

Parent topic: [Printing from a Memory Card](#)

Related references

[Paper Type Settings - Control Panel](#)

Photo Adjustment Options

Select the **Photo Adjustment** options you want to use when printing photos from a memory card or external device. The modifications affect only the printed copy of the photo, not the original file.

Photo Adjustment settings	Available options	Description
Fix Photo	Fix Photo On	Automatically adjusts the brightness, contrast, and saturation of the photo based on the Scene Detection setting that is selected
	Fix Photo Off	Turns off automatic adjustments; see Note below
	P.I.M.	Uses your camera's PRINT Image Matching or Exif Print adjustments
Scene Detection	Automatic	Optimizes the Fix Photo adjustments for specific types of photos; select the option that best matches your photo content
	People	
	Landscape	
	Night Scene	
Fix Red-Eye	Off - All photos	Automatically fixes the red-eye effect in photos
	On - All photos	
Filter	Off	Applies a sepia tone or black-and-white filter to the viewed or printed photo; if printing from a memory card, go back to the previous screen to select this option
	Sepia	
	B&W	
Sharpness	Various settings	Adjusts the sharpness of your photo

Note: To return to default print settings, press the  stop button, select **Yes**, and press the **OK** button.

Note: **Fix Photo** uses a sophisticated face recognition technology to optimize photos that include faces. For this to work, both eyes and the nose must be visible in the subject's face. If your photo includes a

face with an intentional color cast, such as a statue, you may want to turn off **Fix Photo** to retain the special color effects.

Parent topic: [Printing from a Memory Card](#)

Transferring Photos on a Memory Card

You can transfer photos to and from a memory card inserted into a memory card slot on your product.

Note: To use this feature, the product must be connected to your computer over a network.

[Transferring Photos from a Memory Card to Your Computer](#)

Parent topic: [Using Memory Cards With Your Product](#)

Transferring Photos from a Memory Card to Your Computer

You can transfer photos to and from a memory card inserted in your product and a computer connected to your product over a wireless network.

Note: You cannot transfer photos if the product is connected to the computer using a USB cable. Do not transfer photos to and from a memory card while you are printing from the memory card.

1. Make sure the product is connected to the same network as the computer.
2. Insert a memory card into a memory card slot on your product.
3. Do one of the following to access your memory card files from your computer:
 - **Windows:** Open the **Computer**, **My Computer**, **Windows Explorer**, or **File Explorer** utility, then select the removable disk icon.
 - **OS X:** Select the hard drive icon on your desktop or computer window, select your product in the **SHARED** section of the sidebar (you may need to widen the sidebar to see the name), then select the **MEMORYCARD** icon.
4. Select the folder that contains your photos.
5. Drag the photos you want to transfer to the desired folder on your computer or on your memory card.

Note: Your product's LCD screen does not update to display new photos transferred to the memory card. Wait until the memory card access light stops flashing, then remove and insert the memory card to update the photos displayed.

Parent topic: [Transferring Photos on a Memory Card](#)

Related tasks

[Inserting a Memory Card](#)

[Removing a Memory Card](#)

[Viewing the Network Status](#)

Using an External Device with Your Product

Follow the instructions in these sections to use your product with an external device, such as a camera, USB flash drive, or other device.

[Printing from a Camera](#)

[Viewing or Printing from a USB Flash Drive or External Device](#)

Printing from a Camera

If you have a digital camera that supports PictBridge printing, you can print your photos directly from the camera. Check your camera manual to see if it is compatible.

Note: Your photos must be in JPG format and sized from 80 × 80 to 10200 × 10200 pixels. Epson cannot guarantee the compatibility of your camera. Some combinations of paper type, size, and layout may not be supported, depending on your camera and the product settings.

[Selecting Print and Photo Adjustment Settings](#)

[Connecting and Printing from a Camera](#)

[Printing from a Camera Wirelessly](#)

Parent topic: [Using an External Device with Your Product](#)

Selecting Print and Photo Adjustment Settings

Before printing from your camera, you can make image adjustments and select the print settings for your photos. Image adjustments affect only the printed copy of the photo, not the original file.

1. Press the  home button, if necessary.

2. Press the arrow buttons to select **Setup** and press the **OK** button.

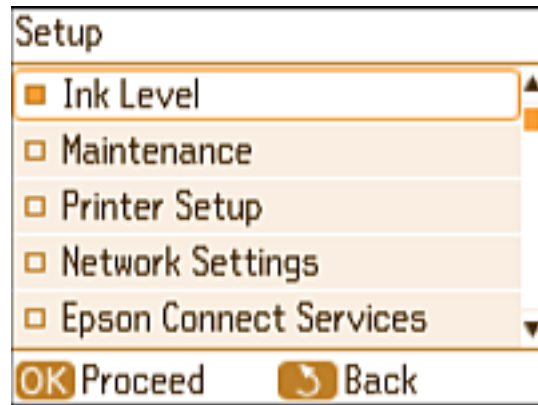

3. Select **External Device Setup** and press the **OK** button.

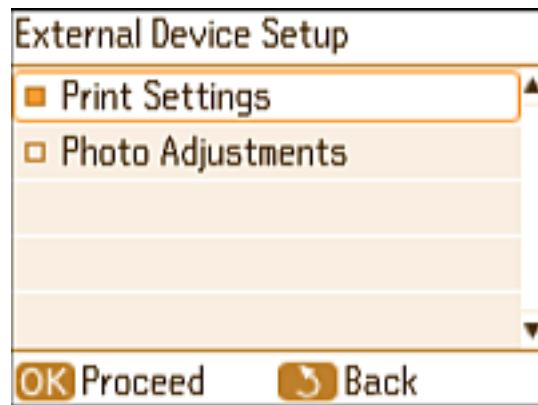

4. Select **Print Settings** and press the **OK** button.

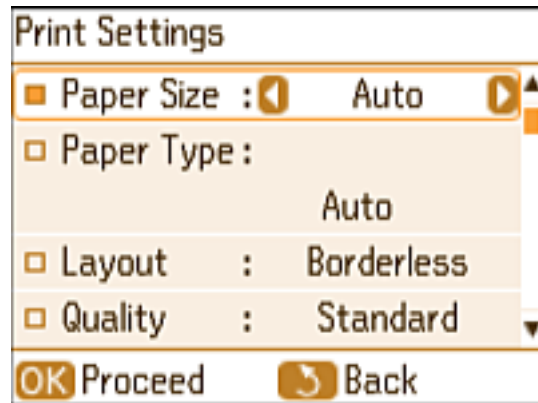

5. Select the print settings you want to use.
6. When you are done, press the ↩ back button.
7. Select **Photo Adjustments** and press the **OK** button.

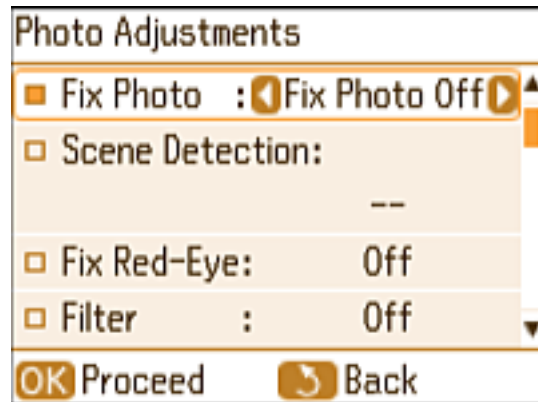

8. Select the photo adjustments you want to use, then press the 🏠 home button to exit. After you select settings, you are ready to connect your camera and print your photos.

Parent topic: [Printing from a Camera](#)

Related references

[Print Setting Options](#)

[Photo Adjustment Options](#)

Related tasks

[Connecting and Printing from a Camera](#)

Connecting and Printing from a Camera

Before you connect your camera, make sure the product is turned on but not printing.

1. Remove any memory cards from the product.
2. Load the paper you want to use for printing.
3. Connect the USB cable that came with your camera to the  USB port on the right side of your product.

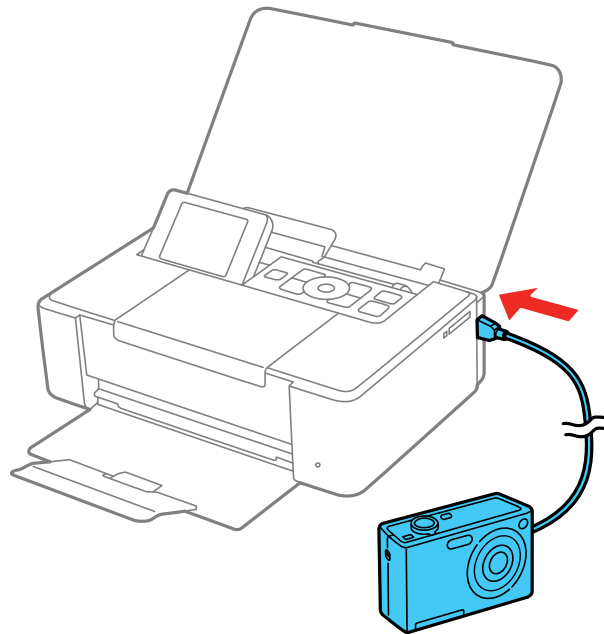

Note: You cannot use the USB port to transfer images from your camera to your computer.

4. Turn on your camera.

5. Follow the instructions that came with your camera to select and print your photos.

When you finish printing, turn off your camera and disconnect it from the product.

Parent topic: [Printing from a Camera](#)

Related tasks

[Removing a Memory Card](#)

Related topics

[Loading Paper](#)

Printing from a Camera Wirelessly

You can print photos from a digital camera using a wireless connection. Make sure your digital camera can connect to a network and is PictBridge compatible (DPS over IP).

1. Remove any memory cards from the product.
2. Load the paper you want to use for printing.
3. Turn on your camera.
4. Setup the camera's wireless network connection. See the documentation that came with your camera for details.

Note: Connect the camera to the same network that your product uses. You can check your product's network settings on the LCD screen.

5. Follow the instructions that came with your camera to select and print your photos.

When you finish printing, turn off your camera and disconnect it from the network.

Parent topic: [Printing from a Camera](#)

Related tasks

[Removing a Memory Card](#)

[Viewing the Network Status](#)

Related topics

[Loading Paper](#)

Viewing or Printing from a USB Flash Drive or External Device

You can view and print photos from a USB thumb drive or other external storage device, such as an external hard drive or CD/DVD burner.

Note: Make sure the files on your device are compatible with the product.

[USB Device File Specifications](#)

[Connecting and Using a USB Flash Drive or External Device](#)

Parent topic: [Using an External Device with Your Product](#)

USB Device File Specifications

You can print external device files that meet these specifications.

File format	JPEG with the Exif version 2.3 standard taken with digital camera using DCF (Design rule for Camera File system) version 1.0 or 2.0 compliant
Image size	80 × 80 pixels to 10200 × 10200 pixels
File size	Up to 2GB
Number of files	Up to 9990



Note: DCF 2.0 files stored in a camera's built-in memory are not supported.

Parent topic: [Viewing or Printing from a USB Flash Drive or External Device](#)

Connecting and Using a USB Flash Drive or External Device

Before you connect your thumb drive or device, make sure the product is turned on but not printing.

Note: Epson cannot guarantee the compatibility of your drive.

1. Remove any memory cards from the product.
2. Load the paper you want to use for printing.
3. Insert your USB thumb drive or the USB cable that came with your external device into the  USB port on the front of your product. If connecting an external CD/DVD drive, insert a CD or DVD into the drive.
4. Press the  home button, if necessary.
5. Press the arrow buttons to select **Print Photos** and press the **OK** button.
6. Select **View and Print Photos** and press the **OK** button

7. Select the photos to print from the LCD screen.

When you finish printing, make sure the access light on the drive is not flashing, then remove or disconnect it from the product.

Caution: Do not remove the USB drive or turn off the product when the access light is flashing, or you may lose photos on the drive.

Parent topic: [Viewing or Printing from a USB Flash Drive or External Device](#)

Related topics

[Loading Paper](#)

Replacing the Ink Cartridge

When the ink cartridge is expended, you need to replace it.

You may also need to replace a cartridge that is more than six months old, if your printouts do not look their best, even after cleaning and aligning the print head.

Note: Please dispose of your used Epson branded ink cartridges responsibly and in accordance with local requirements. If you would like to return your used ink cartridges to Epson for proper disposal, please go to epson.com/recycle for more information.

[Check Cartridge Status](#)

[Purchase Epson Ink Cartridges](#)

[Removing and Installing the Ink Cartridge](#)

Check Cartridge Status

Your product and its printing software will let you know when the ink cartridge is low or expended.

[Checking Cartridge Status on the LCD Screen](#)

[Checking Cartridge Status with Windows](#)

[Checking Cartridge Status with OS X](#)

Parent topic: [Replacing the Ink Cartridge](#)

Checking Cartridge Status on the LCD Screen

You can check the status of your ink cartridge using your product's LCD screen.

1. Press the  home button, if necessary.

2. Press the arrow buttons to select **Setup** and press the **OK** button.

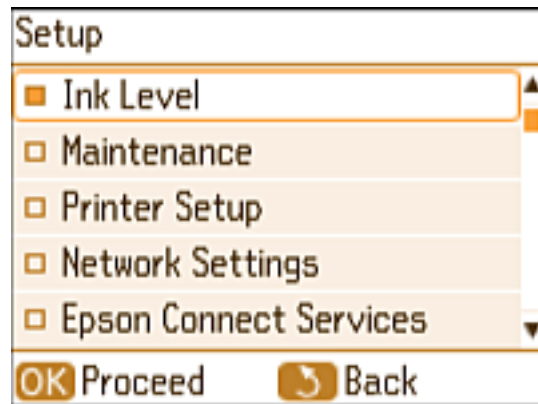

3. Select **Ink Level** and press the **OK** button.
The ink cartridge status is displayed.

Note: Displayed ink level is approximate.

4. Press the **OK** button to exit.

Parent topic: [Check Cartridge Status](#)

Related tasks

[Removing and Installing the Ink Cartridge](#)

Checking Cartridge Status with Windows

A low ink reminder appears if you try to print when ink is low, and you can check your cartridge status at any time using a utility on your Windows computer.

1. To check your cartridge status, access the Windows Desktop and double-click the product icon in the Windows taskbar.

You see this window:

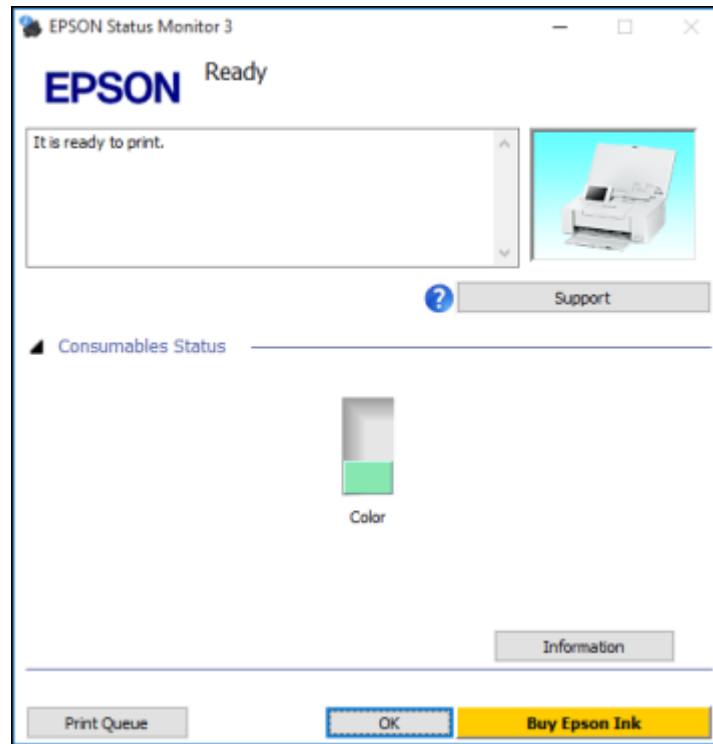

2. Replace or reinstall the ink cartridge, if necessary.

Note: If the cartridge is broken, incompatible with the product model, or improperly installed, Epson Status Monitor will not display an accurate cartridge status.

3. To disable the low ink reminder, right-click the product icon in the Windows taskbar and select **Monitoring Preferences**.

You see this window:

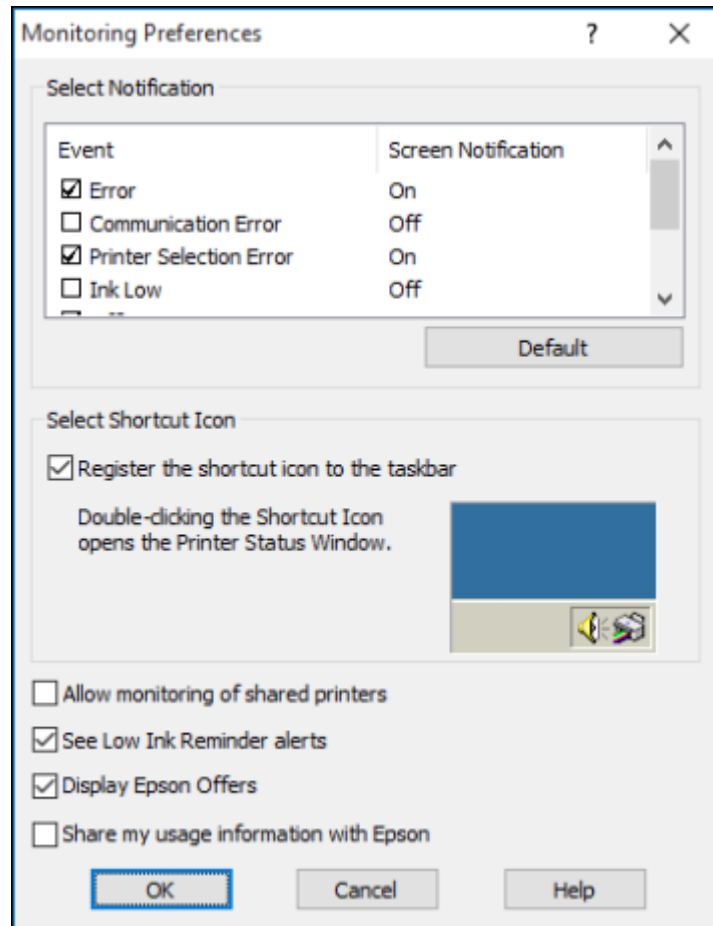

4. Deselect the **See Low Ink Reminder alerts** checkbox at the bottom of the screen.
5. To disable promotional offers, deselect the **Display Epson Offers** checkbox.

Parent topic: [Check Cartridge Status](#)

Related tasks

[Removing and Installing the Ink Cartridge](#)

Checking Cartridge Status with OS X

You can check your cartridge status using a utility on your Mac.

1. In the Apple menu or the Dock, select **System Preferences**. Select **Print & Fax**, **Print & Scan**, or **Printers & Scanners**, select your product, and select **Options & Supplies**. Select **Utility** and select **Open Printer Utility**.
2. Select **EPSON Status Monitor**.

You see a window like this:

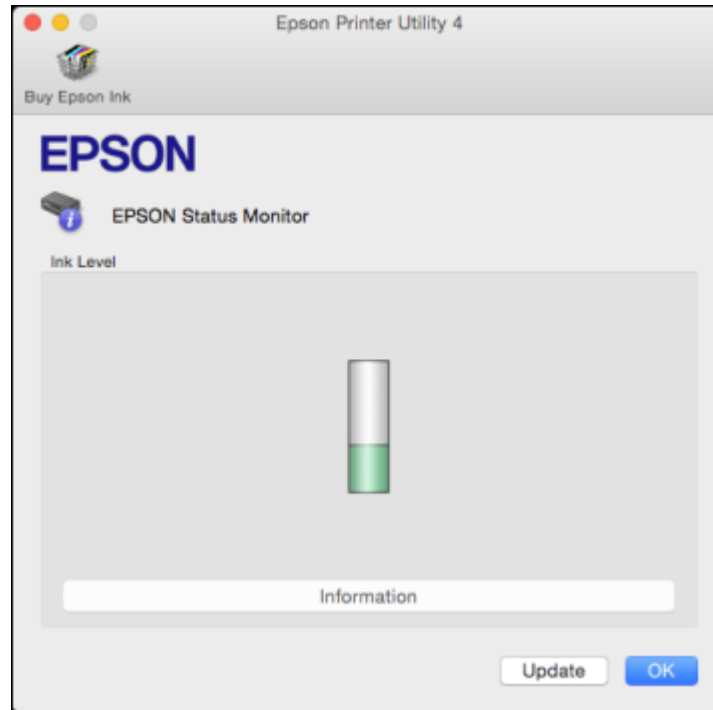

3. Do the following as necessary:
 - To update the ink cartridge status, click **Update**.

- Replace or reinstall the ink cartridge, if necessary.

Note: If the cartridge is broken, incompatible with the product model, or improperly installed, Epson Status Monitor will not display an accurate cartridge status.

Parent topic: [Check Cartridge Status](#)

Related tasks

[Removing and Installing the Ink Cartridge](#)

Purchase Epson Ink Cartridges

You can purchase genuine Epson ink and paper at epson.com/ink3 (U.S. sales) or epson.ca (Canadian sales). You can also purchase supplies from an Epson authorized reseller. To find the nearest one, call 800-GO-EPSON (800-463-7766).

Note: This product uses only genuine Epson-brand cartridges. Other brands of ink cartridges and ink supplies are not compatible and, even if described as compatible, may not function properly.

The cartridge included with the printer is designed for printer setup and not for resale. After some ink is used for charging, the rest is available for printing. Yields vary considerably based on images printed, print settings, paper type, frequency of use, and temperature. For print quality, a variable amount of ink remains in the cartridge after the "replace cartridge" indicator comes on.

[Ink Cartridge Part Numbers](#)

Parent topic: [Replacing the Ink Cartridge](#)

Ink Cartridge Part Numbers

Use these part numbers when you order or purchase new ink cartridges.

Note: For best printing results, use up a cartridge within 6 months of opening the package.

Part number	Description
320	Color Ink Cartridge
320P	Print Pack - Color Ink Cartridge and Glossy Photo Paper (100 sheets)

Parent topic: [Purchase Epson Ink Cartridges](#)

Removing and Installing the Ink Cartridge

Make sure you have a replacement cartridge handy before you begin. You must install the new cartridge immediately after removing the old one.

Caution: Leave your old cartridge in the printer until you are ready to replace it to prevent the print head nozzles from drying out. Do not open ink cartridge packages until you are ready to install the ink. Cartridges are vacuum packed to maintain reliability.

Note: If you remove a low or expended ink cartridge, you cannot re-install and use the cartridge.

1. Turn on your product.
2. Do one of the following:
 - If the ink cartridge is expended, you see a message on the LCD screen. Press the **OK** button.
 - If you are replacing the cartridge before you see a message on the LCD screen, select **Setup > Maintenance > Ink Cartridge Replacement**. Then press the **OK** button to proceed.
3. Unpack the new ink cartridge and completely remove only the yellow tape.

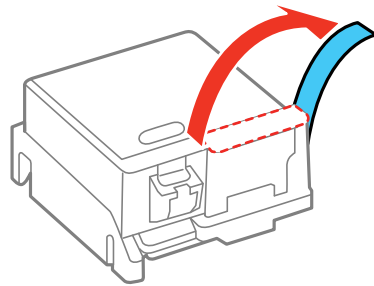

Caution: Do not remove any other labels or seals, or ink may leak.

4. Remove the cap as shown. Retain the cap so that you can use it to recap the used cartridge you are replacing.

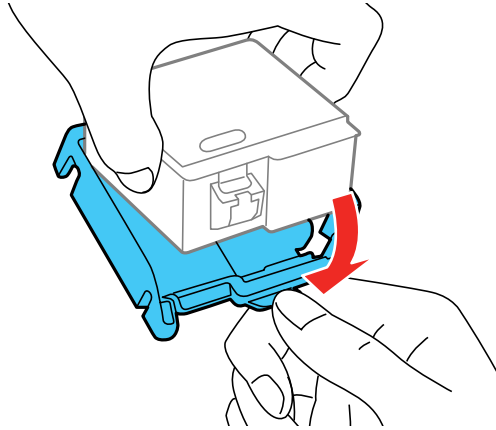

Caution: Do not touch the ink cartridge areas shown here. Doing so may prevent normal operation and printing.



Warning: If ink gets on your skin, wash it thoroughly with soap and water. If ink gets into your eyes, flush them immediately with water. If ink gets into your mouth, spit it out and see a doctor right away. Keep ink cartridges out of the reach of children.

5. Press the  start button.

6. Open the inner cover.

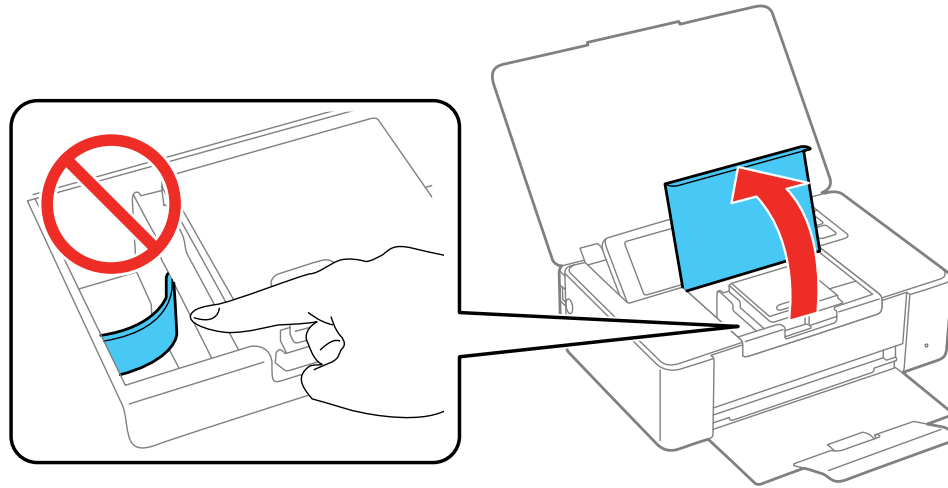

Caution: Do not move the print head by hand; otherwise, you may damage your product. Do not touch the flat white cable inside the product.

7. Press down the blue tab to unlock the used ink cartridge, then lift it out.

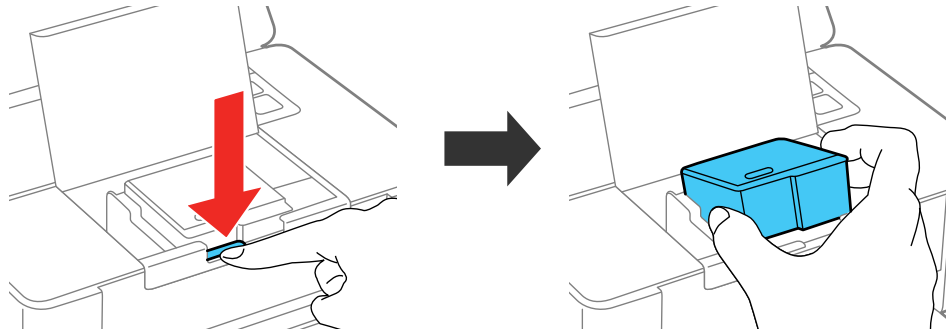

8. Use the cap from the replacement ink cartridge to recap the used cartridge before disposing of it.

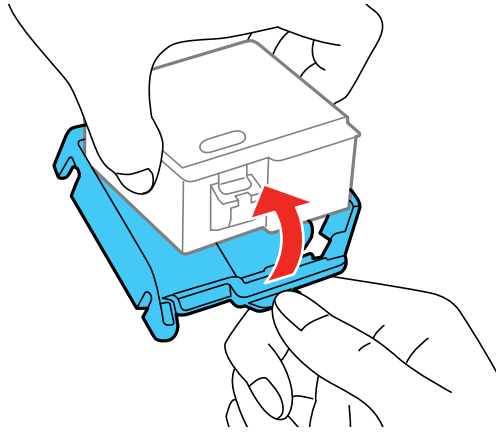

Note: Dispose of used cartridges carefully. Do not take the used cartridge apart or try to refill it.

9. Hold the cartridge with the green chip facing you and insert the cartridge at an angle as shown. Press down the ink cartridge until it clicks into place.

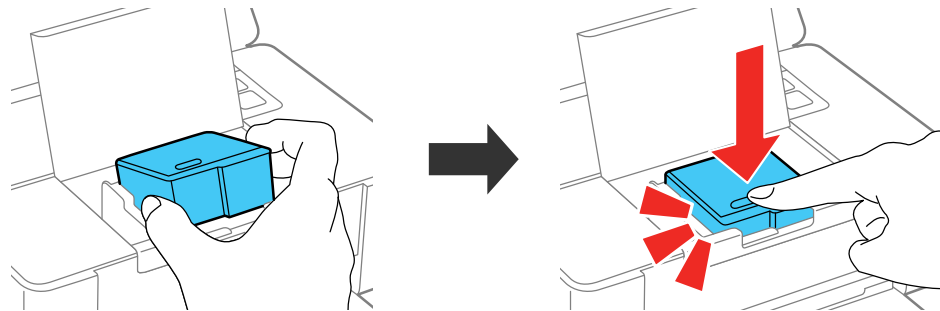

Caution: Make sure to insert the ink cartridge in the correct direction or you may damage the product.

10. Close the inner cover.
11. Press the  start button to start charging the ink. Then follow the rest of the on-screen instructions.

Ink charging takes a few minutes. When you see a completion message on the LCD screen, ink replacement is complete.

Caution: Do not turn off the product or open the inner cover while ink is charging or you may not be able to print.

Caution: If you remove an ink cartridge for later use, recap the ink cartridge using the cap that came with it to prevent the ink from drying out and to protect the surrounding area from getting smeared by ink. Store the ink cartridge in the same environment as the product. Do not leave the product with the ink cartridges removed for an extended period of time. Otherwise, ink remaining in the print head nozzles may dry out and you may not be able to print.

Parent topic: [Replacing the Ink Cartridge](#)

Related concepts

[Purchase Epson Ink Cartridges](#)

Adjusting Print Quality

If your print quality declines, you may need to run a utility to clean or align the print head.

If running these utilities does not solve the problem, you may need to replace the ink cartridge.

[Print Head Maintenance](#)

[Print Head Alignment](#)

[Cleaning the Paper Path](#)

Print Head Maintenance

If your printouts become too light, or you see dark or light bands across them, you may need to clean the print head nozzles. Cleaning uses ink, so clean the nozzles only if print quality declines.

You can check for clogged nozzles before you clean them so you don't clean them unnecessarily.

Note: You cannot clean the print head if the ink cartridge is expended, and may not be able to clean it when the cartridge is low. You must replace the cartridge first.

[Print Head Nozzle Check](#)

[Print Head Cleaning](#)

Parent topic: [Adjusting Print Quality](#)

Related topics

[Replacing the Ink Cartridge](#)

Print Head Nozzle Check

You can print a nozzle check pattern to check for clogged nozzles.

[Checking the Nozzles Using the Product Control Panel](#)

[Checking the Nozzles Using a Computer Utility](#)

Parent topic: [Print Head Maintenance](#)

Checking the Nozzles Using the Product Control Panel

You can check the print head nozzles using the control panel on your product.

1. Load paper in this size in your product: 4 × 6 inches (102 × 152 mm).
2. Press the  home button, if necessary.

3. Press the arrow buttons to select **Setup** and press the **OK** button.
4. Select **Maintenance** and press the **OK** button.

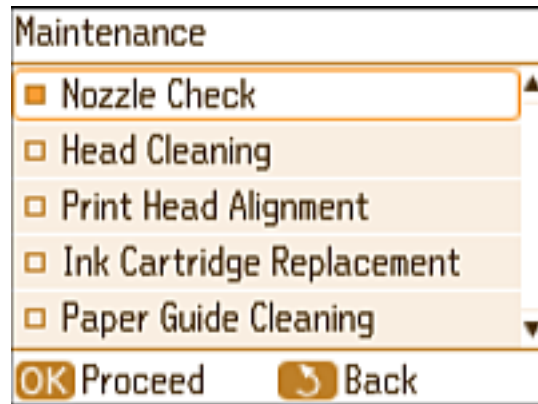

5. Select **Nozzle Check** and press the **OK** button.

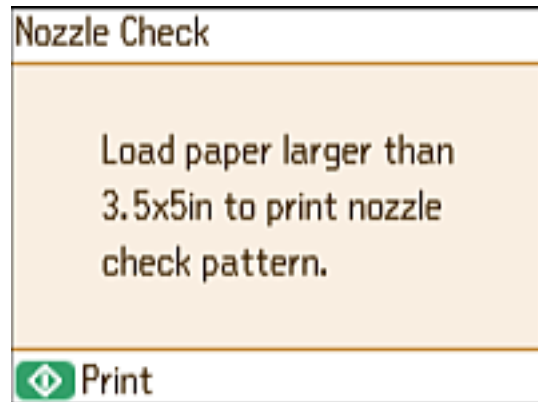

6. Press the  start button.
The nozzle check pattern is printed.

7. Check the printed pattern to see if there are gaps in the lines.

Print head is clean

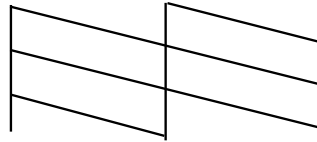

Print head needs cleaning

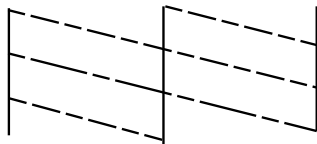

8. Do one of the following:

- If there are no gaps, the print head is clean. Select **Finish Nozzle Check** and press the **OK** button.
- If there are gaps or the pattern is faint, select **Head Cleaning** and press the **OK** button. Follow the instructions on the screen to clean the print head, check the nozzles, and repeat the process as necessary.

If you don't see any improvement after cleaning the print head up to 2 times, turn the product off and wait at least 6 hours. Then check the print head nozzles and try cleaning the print head again, if necessary. If quality still does not improve, contact Epson.

Parent topic: [Print Head Nozzle Check](#)

Related tasks

[Cleaning the Print Head Using the Product Control Panel](#)

Related topics

[Loading Paper](#)

[Replacing the Ink Cartridge](#)

Checking the Nozzles Using a Computer Utility

You can check the print head nozzles using a utility on your Windows or Mac computer.

1. Make sure there are no errors on the LCD screen.
2. Load paper in this size in your product: 4 × 6 inches (102 × 152 mm).
3. Do one of the following:
 - **Windows:** Access the Windows Desktop and right-click the product icon in the Windows taskbar.
 - **OS X:** In the Apple menu or the Dock, select **System Preferences**. Select **Print & Fax**, **Print & Scan**, or **Printers & Scanners**, select your product, and select **Options & Supplies**. Select **Utility** and select **Open Printer Utility**.
4. Select **Nozzle Check**.

You see a window like this:

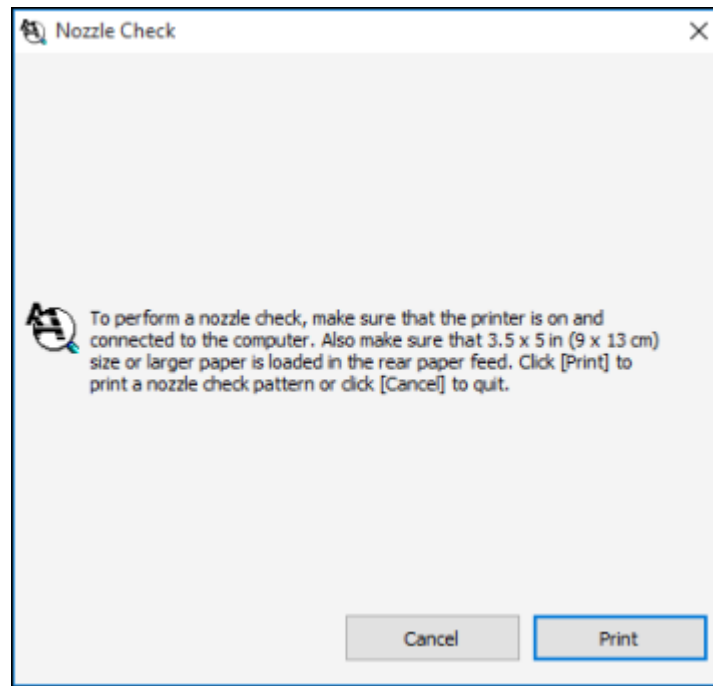

5. Click **Print**.

6. Check the printed pattern to see if there are gaps in the lines.

Print head is clean

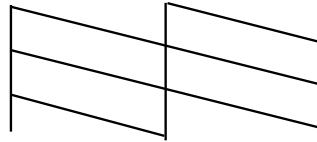

Print head needs cleaning

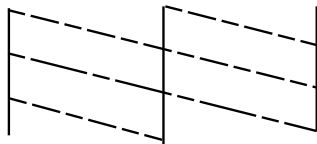

7. If there are no gaps, click **Finish**.

If there are gaps or the pattern is faint, clean the print head.

Parent topic: [Print Head Nozzle Check](#)

Related tasks

[Cleaning the Print Head Using a Computer Utility](#)

Related topics

[Loading Paper](#)

[Replacing the Ink Cartridge](#)

Print Head Cleaning

If print quality has declined and the nozzle check pattern indicates clogged nozzles, you can clean the print head.

Note: You cannot clean the print head if the ink cartridge is expended, and may not be able to clean it when the cartridge is low. You must replace the cartridge first.

[Cleaning the Print Head Using the Product Control Panel](#)

[Cleaning the Print Head Using a Computer Utility](#)

Parent topic: [Print Head Maintenance](#)

Related topics

[Replacing the Ink Cartridge](#)

Cleaning the Print Head Using the Product Control Panel

You can clean the print head nozzles using the control panel on your product.

1. Load paper in this size in your product: 4 × 6 inches (102 × 152 mm).
2. Press the  home button, if necessary.
3. Press the arrow buttons to select **Setup** and press the **OK** button.
4. Select **Maintenance** and press the **OK** button.

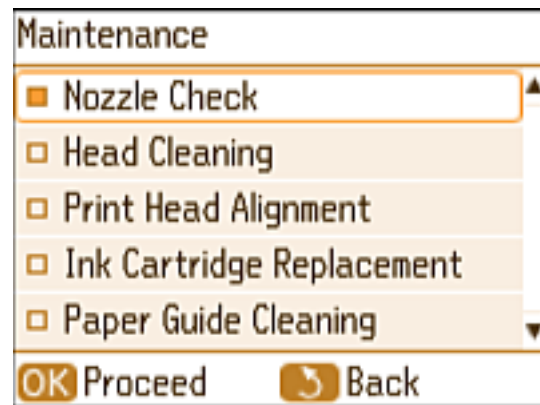

5. Select **Head Cleaning** and press the **OK** button.

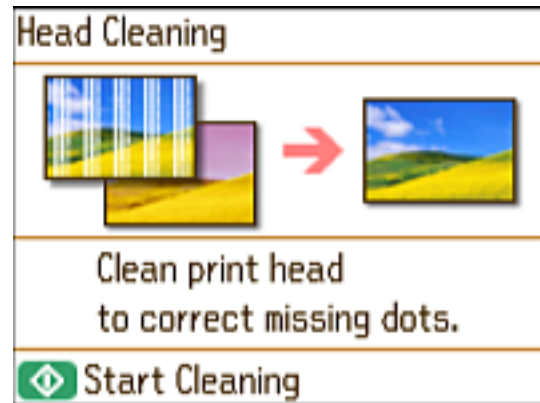

6. Press the  start button to clean the print head. You see a print head cleaning message on the LCD screen during the cleaning cycle.

Caution: Never turn off the product during a cleaning cycle or you may damage it.

When the cleaning cycle is finished, you see a completion message on the display screen.

7. Select **Nozzle Check** and press the **OK** button.
8. Press the  start button to run a nozzle check and confirm that the print head is clean.

If you don't see any improvement after cleaning the print head up to 2 times, turn the product off and wait at least 6 hours. Then check the print head nozzles and try cleaning the print head again, if necessary. If quality still does not improve, contact Epson.

Parent topic: [Print Head Cleaning](#)

Related tasks

[Checking the Nozzles Using the Product Control Panel](#)

Related topics

[Loading Paper](#)

[Replacing the Ink Cartridge](#)

Cleaning the Print Head Using a Computer Utility

You can clean the print head using a utility on your Windows or Mac computer.

1. Make sure there are no errors on the LCD screen.
2. Load paper in this size in your product: 4 × 6 inches (102 × 152 mm).
3. Do one of the following:
 - **Windows:** Access the Windows Desktop and right-click the product icon in the Windows taskbar.
 - **OS X:** In the Apple menu or the Dock, select **System Preferences**. Select **Print & Fax**, **Print & Scan**, or **Printers & Scanners**, select your product, and select **Options & Supplies**. Select **Utility** and select **Open Printer Utility**.
4. Select **Head Cleaning**.

You see a window like this:

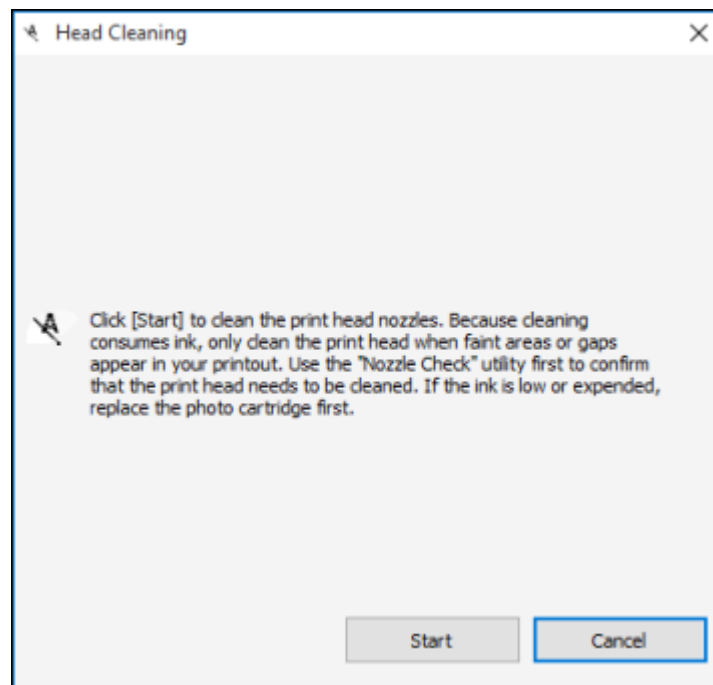

5. Click **Start** to begin the cleaning cycle.

Caution: Never turn off the product during a cleaning cycle or you may damage it.

6. When the cleaning cycle is finished, you can check to see if the nozzles are clean; click **Print Nozzle Check Pattern** and click **Print**.
7. Check the printed pattern to see if there are gaps in the lines.

Print head is clean

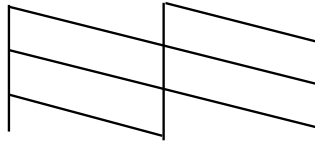

Print head needs cleaning

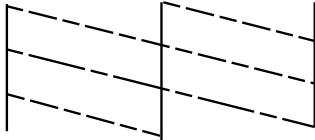

- If there are no gaps, click **Finish**.
- If there are gaps or the pattern is faint, click **Clean** to clean the print head again.

If you don't see any improvement after cleaning the print head up to 2 times, turn the product off and wait at least 6 hours. Then check the print head nozzles and try cleaning the print head again, if necessary. If quality still does not improve, contact Epson.

Parent topic: [Print Head Cleaning](#)

Related tasks

[Checking the Nozzles Using a Computer Utility](#)

Related topics

[Loading Paper](#)

[Replacing the Ink Cartridge](#)

Print Head Alignment

If your printouts become grainy or blurry, you notice misalignment of vertical lines, or you see dark or light horizontal bands, you may need to align the print head.

Note: Banding may also occur if your print head nozzles need cleaning.

[Aligning the Print Head Using the Product Control Panel](#)

Parent topic: [Adjusting Print Quality](#)

Aligning the Print Head Using the Product Control Panel

You can align the print head using the control panel on your product.

1. Load paper in this size in your product: 4 × 6 inches (102 × 152 mm).
2. Press the  home button, if necessary.
3. Press the arrow buttons to select **Setup** and press the **OK** button.
4. Select **Maintenance** and press the **OK** button.

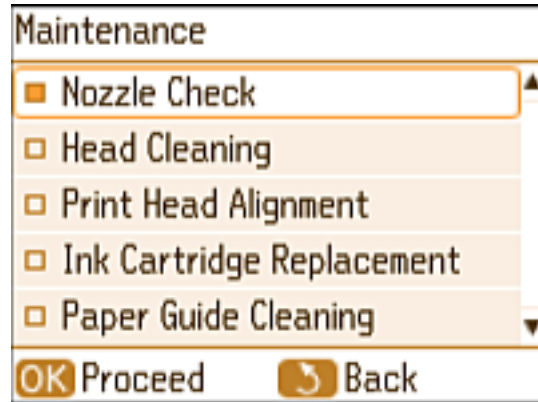

5. Select **Print Head Alignment** and press the **OK** button.

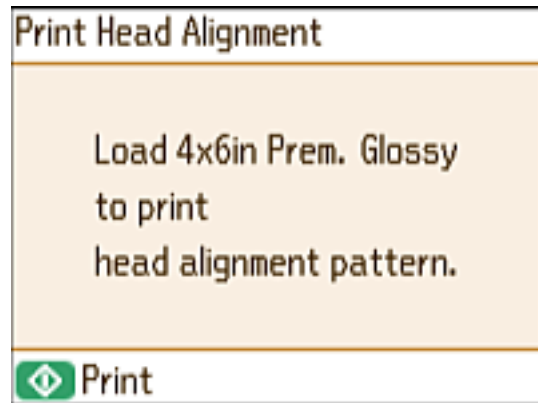

6. Press the  start button to print an alignment sheet.

Note: Do not cancel printing while you are printing a head alignment pattern.

7. Check the printed pattern and press the up or down arrow button to select the number representing the most solid printed pattern for the first set, then press the **OK** button.

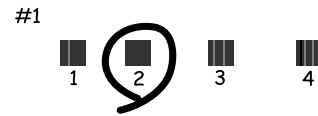

8. Repeat the previous step to select the best printed pattern for each set.

Parent topic: [Print Head Alignment](#)



Related topics

[Loading Paper](#)

Cleaning the Paper Path

If your printouts are smeared or scuffed, or your paper does not feed correctly, clean the paper path inside the printer.

Caution: Do not use tissues to clean the rollers inside the product; lint from tissues may clog the print head nozzles.

1. Load a few sheets of plain paper in the product.
2. Press the  home button, if necessary.
3. Press the arrow buttons to select **Setup** and press the **OK** button.
4. Select **Maintenance** and press the **OK** button.
5. Select **Paper Guide Cleaning** and press the **OK** button.
6. Press the  start button to begin cleaning the paper guide.
7. Repeat as necessary until the paper comes out clean.

Parent topic: [Adjusting Print Quality](#)

Related topics

[Loading Paper](#)

Transporting and Cleaning Your Product

Follow the instructions in these sections to transport your product or clean it if necessary.

[Carrying and Transporting Your Product](#)

[Cleaning Your Product](#)

Carrying and Transporting Your Product

Whenever you transport your product, prepare it as described here.

Caution: Observe the following precautions when transporting the product:

- Avoid tilting the product, placing it vertically, or turning it upside down; otherwise ink may leak.
- Leave the ink cartridge installed. Removing the cartridge can dry out the print head and may prevent the product from printing.
- Avoid strong impacts which may damage the product.
- Do not leave the product in direct sunlight, near heat sources, or inside cars or other hot locations. The product may be deformed or ink may leak.

1. Press the  power button to turn off the product.
2. Make sure the green power light on the front of the product is turned off and then unplug the power cord.

Caution: Make sure the power light is off before unplugging the power cord; otherwise, the print head may not return to the home position. This can cause the print head to dry out and may prevent the product from printing.

3. Remove all the paper.
4. Remove any memory cards inserted in the product.
5. Disconnect any connected cables.

6. Close the LCD screen, cover, and output tray.

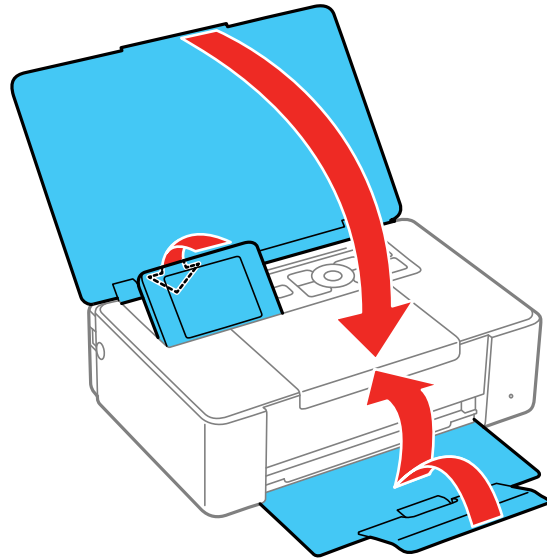

7. Place the product in a bag if traveling a short distance, or in its original packaging materials (or equivalent packing materials) when transporting the product a long distance.

If print quality has declined when you print again, clean and align the print head.

Parent topic: [Transporting and Cleaning Your Product](#)

Related concepts

[Print Head Maintenance](#)

[Print Head Alignment](#)

Related tasks

[Removing a Memory Card](#)

Cleaning Your Product

To keep your product working at its best, you should clean it whenever necessary. Close the cover and output tray when you are not using the product to protect it from dust.

Caution: Do not use a hard brush, benzene, alcohol, or paint thinner to clean the product or you may damage it. Do not use oil or other lubricants inside the product or let water get inside.

1. Turn off the product.
2. Unplug the power cable.
3. Disconnect any connected cables.
4. Remove all the paper.
5. Remove any memory cards inserted in the product.
6. Clean the outer case and control panel with a soft, dry cloth. Do not use any liquid or chemical cleansers.

Parent topic: [Transporting and Cleaning Your Product](#)

Related tasks

[Removing a Memory Card](#)

Solving Problems

Check these sections for solutions to problems you may have using your product.

[Checking for Software Updates](#)

[Product Status Messages](#)

[Running a Product Check](#)

[Resetting Control Panel Defaults](#)

[Solving Setup Problems](#)

[Solving Network Problems](#)

[Solving Paper Problems](#)

[Solving Problems Printing from a Computer](#)

[Solving Page Layout and Content Problems](#)

[Solving Print Quality Problems](#)

[Solving Memory Card Problems](#)

[Uninstall Your Product Software](#)

[Where to Get Help](#)

Checking for Software Updates

Periodically, it's a good idea to check Epson's support website for free updates to your product software. You can select **Download the Latest Software** from the Home screen of this manual or visit Epson's driver download site ([U.S. downloads](#) or [Canadian downloads](#)).

- **Windows:** Your printer software automatically checks for updates. You can also manually update the software by selecting **Software Update** here:
 - Accessing the Windows Desktop and right-clicking the product icon in the Windows taskbar
 - On the **Maintenance** tab in the printer settings window

You can also update the software by selecting **EPSON Software Updater** in the **EPSON** or **EPSON Software** program group, accessible by the **Start** button, or on the **Start** or **Apps** screens, depending on your version of Windows.

- **OS X:** You can manually update the software by opening the **Applications > Epson Software** folder and selecting **EPSON Software Updater**.

Parent topic: [Solving Problems](#)

Related tasks

[Changing Automatic Update Options](#)

Product Status Messages

You can often diagnose problems with your product by checking the messages on its LCD screen. You can also see help information and how-to instructions on the screen. Press the  home button, if necessary, select **Help** and press the **OK** button.

LCD screen message	Condition/solution
Printer error	Turn the product off and then back on again. If the error continues, check for a paper jam. If there is no paper jam, contact Epson for support.
Operation canceled. An error occurred while saving.	The memory card or external storage device has a problem or may be damaged. Make sure the memory card or external device is inserted correctly and meets the specifications for the product.
Paper Configuration is disabled	The Paper Configuration setting must be turned on to use AirPrint. Keep this setting enabled unless you always use the same size and type of paper and do not need to change the paper settings.
Ink is low	You can continue printing until you are prompted to replace the ink cartridge.
A printer's ink pad is nearing the end of its service life	An ink pad is near the end of its service life and the message will be displayed until the ink pad is replaced. Contact Epson for support. (To resume printing, press the  start button.)
A printer's ink pad is at the end of its service life	An ink pad is at the end of its service life. Turn off the product and contact Epson for support.
Combination of IP address and subnet mask is invalid	There is a problem with the network connection to your product. Check the solution links in this topic.
Recovery mode	An error has occurred during firmware updating. Connect your product using a USB cable and try updating the firmware again. If you still see this error message, contact Epson for support.

Note: The ink pads in the printer collect, distribute, and contain the ink that is not used on printed pages. During the life of your product it may reach a condition where either satisfactory print quality cannot be maintained or the ink pads have reached the end of their usable life. The Epson Status Monitor, your LCD screen, or lights on the control panel will advise you when these parts need replacing. If this happens during the standard warranty of the product, the exchange of the product or replacement of the

pads is covered under the standard warranty. If the product is out of warranty, the pads can be replaced by any Epson authorized service provider. The waste ink pads are not a user-replaceable part.

Parent topic: [Solving Problems](#)

Related references

[Paper Jam Problems Inside the Product](#)

[Where to Get Help](#)

Related tasks

[Selecting the Paper Source Settings - Control Panel](#)

[Using AirPrint](#)

Related topics

[Loading Paper](#)

[Replacing the Ink Cartridge](#)

[Using Memory Cards With Your Product](#)

Running a Product Check

Running a product check helps you determine if your product is operating properly.

1. Disconnect any interface cables connected to your product.
2. Load paper in this size in your product: 4 × 6 inches (102 × 152 mm).
3. Press the  home button, if necessary.
4. Press the arrow buttons to select **Setup** and press the **OK** button.

5. Select **Maintenance** and press the **OK** button.

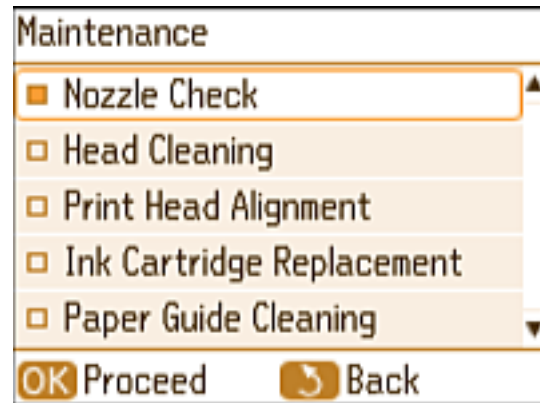

6. Select **Nozzle Check** and press the **OK** button.

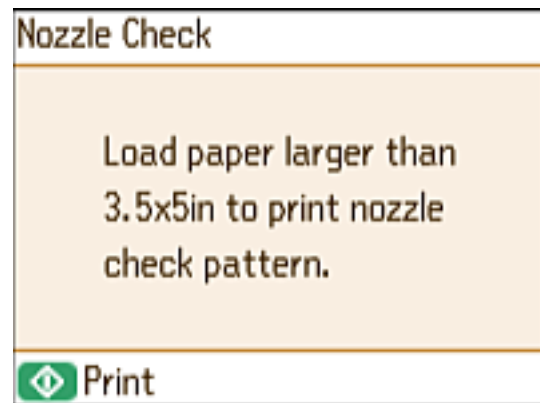

7. Press the  start button.
The nozzle check pattern is printed.
8. Do one of the following, depending on the results of the product check:
 - If the page prints and the nozzle check pattern is complete, the product is operating properly. Any operation problem you may have could be caused by your computer, cable, software, or selected settings. Check for other solutions or try uninstalling and reinstalling your printer software.

- If the page prints but the nozzle check pattern has gaps, clean or align the print head.
- If the page does not print, the product may have a problem. Check for other solutions. If they do not work, contact Epson.

Parent topic: [Solving Problems](#)

Related concepts

[Print Head Cleaning](#)

[Print Head Alignment](#)

[Uninstall Your Product Software](#)

Related references

[Where to Get Help](#)

Resetting Control Panel Defaults

If you have a problem with settings on the product control panel, you can reset them to their factory defaults. You can choose which settings to reset or reset them all.

1. Press the  home button, if necessary.
2. Press the arrow buttons to select **Setup** and press the **OK** button.
3. Select **Restore Default Settings** and press the **OK** button.

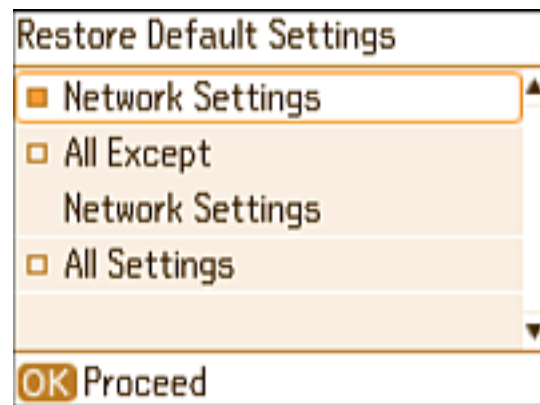

4. Select one of these options:
 - **Network Settings:** Resets all network settings.

- **All Except Network Settings:** Resets all control panel settings, except for network settings.
- **All Settings:** Resets all control panel settings.

You see a confirmation screen.

5. Select **Yes** to reset the selected settings. (Select **No** if you want to cancel the operation.)

Parent topic: [Solving Problems](#)

Solving Setup Problems

Check these sections if you have problems while setting up your product.

[Noise After Ink Installation](#)

[Software Installation Problems](#)

[USB Connection Problems](#)

Parent topic: [Solving Problems](#)

Noise After Ink Installation

If you hear noises from your product after installing ink, check the following:

- The first time you install the ink cartridge, the product must charge its print head. Wait until charging finishes before you turn off the product, or it may charge improperly and use excess ink the next time you turn it on.
- If the product's print head stops moving or making noise, and the charging process has not finished after approximately 5 minutes, turn off your product. Turn it back on and check to see if charging is still in progress. If it is still in progress, contact Epson for help.

Parent topic: [Solving Setup Problems](#)

Related references

[Where to Get Help](#)

Software Installation Problems

If you have problems while installing your product software, try these solutions:

- Make sure your product is turned on and any necessary cables are securely connected at both ends. If you still have problems installing software, disconnect the cable and carefully follow the instructions on the *Start Here* sheet. Also make sure your system meets the requirements for your operating system.
- Close any other programs, including screen savers and virus protection software, and install your product software again.

- In Windows, make sure your product is selected as the default printer and the correct port is shown in the printer properties.
- If you see any error message or your software does not install correctly in Windows, you may not have software installation privileges. Contact your System Administrator.

Parent topic: [Solving Setup Problems](#)

Related concepts

[Uninstall Your Product Software](#)

Related references

[Windows System Requirements](#)

[OS X System Requirements](#)

USB Connection Problems

If you used a USB cable to connect to a computer that has multiple peripherals, make sure the computer is grounded. Otherwise, you may feel a slight electric shock when touching your product.

Parent topic: [Solving Setup Problems](#)

Solving Network Problems

Check these solutions if you have problems setting up or using your product on a network.

Note: Breakdown or repair of this product may cause loss of network data and settings. Epson is not responsible for backing up or recovering data and settings during or after the warranty period. We recommend that you make your own backup or print out your network data and settings.

[Product Cannot Connect to a Wireless Router or Access Point](#)

[Network Software Cannot Find Product on a Network](#)

[Product Does Not Appear in OS X Printer Window](#)

[Cannot Print Over a Network](#)

Parent topic: [Solving Problems](#)

Product Cannot Connect to a Wireless Router or Access Point

If your product has trouble finding or connecting to a wireless router or access point, try these solutions:

- If you are connecting the product via Wi-Fi Protected Setup (WPS) and the Wi-Fi icon on your product's LCD screen is not lit or does not appear, make sure you select one of the WPS options from the product control panel within 2 minutes of pressing the WPS button on your router.

- Make sure to place your product within contact range of your 2.4 GHz router or access point. Avoid placing your product near a microwave oven, 2.4 GHz cordless phone, or large metal object, such as a filing cabinet.

Note: If you are using a 5 GHz wireless router, set the router to operate in dual band (2.4 GHz and 5 GHz) mode. See your router documentation for instructions.

- Verify that your router or access point is operating correctly by connecting to it from your computer or another device.
- You may need to disable the firewall and any anti-virus software on your wireless router or access point.
- Check to see if access restrictions, such as MAC address filtering, are set on the router or access point. If access restrictions are set, add your product's MAC address to your router's address list. To obtain your product's MAC address, check the network status on the LCD screen. Then follow the instructions in your router or access point documentation to add the address to the list.
- If your router or access point does not broadcast its network name (SSID), follow the instructions that came with your product to enter your wireless network name manually.
- If your router or access point has security enabled, determine the kind of security it is using and any required password or passphrase for connection. Then make sure to enter the exact WEP key or WPA passphrase correctly.
- Check if your computer is restricting the available wireless channels. If so, verify that your wireless access point is using one of the usable channels and change to a usable channel, if necessary.
- If you are using a Wi-Fi Direct connection that suddenly disconnects, the Wi-Fi direct password on your device may have been changed. If necessary, delete the existing **DIRECT-xxxxxxx** connection settings from your device and enter a new password. See your device documentation for instructions.
- If you connected your product to a Windows computer using Wi-Fi Direct and it automatically selected Access Point Mode, you may have trouble accessing a low-priority Internet connection. Check the network connection or adapter settings in the Windows Control Panel and set the **Internet metric** setting to **100** for your version of the Internet Protocol.

Parent topic: [Solving Network Problems](#)

Related tasks

[Selecting Wireless Network Settings from the Control Panel](#)

[Enabling Wi-Fi Direct Mode](#)

Related topics

[Wi-Fi Networking](#)

Network Software Cannot Find Product on a Network

If EpsonNet Setup cannot find your product on a network, try these solutions:

- Make sure your product is turned on and connected to your network. Verify connection using your product control panel.
- Check if your network name (SSID) contains non-ASCII characters. Your product cannot display non-ASCII characters.
- Make sure your product is not connected to a guest network.
- If necessary, reinstall your product software and try running EpsonNet Setup again:
 1. Reset your product's network settings to their factory defaults.
 2. Windows only: uninstall your product software.
 3. Initialize your router following the instructions in your router documentation.

Note: If you are reading these instructions online, you will lose your Internet connection when you initialize your router, so note the next step before initializing it.

4. Download your product software from the Epson website using the instructions on the *Start Here* sheet.
- If you have replaced your router, reinstall your product software to connect to the new router.

Note: If you are using a 5 GHz wireless router, set the router to operate in dual band (2.4 GHz and 5 GHz) mode. See your router documentation for instructions.

Parent topic: [Solving Network Problems](#)

Related tasks

[Connecting to a New Wi-Fi Router](#)

Related topics

[Wi-Fi Networking](#)

Product Does Not Appear in OS X Printer Window

If your product does not appear in the OS X printer window, try these solutions:

- Turn your product off, wait 30 seconds, then turn it back on again.

- If you are connecting the product via Wi-Fi Protected Setup (WPS) and the Wi-Fi icon on your product's LCD screen is not lit, make sure you select one of the WPS options from the product control panel within 2 minutes of pressing the WPS button on your router.
- If you are connecting the product wirelessly via EpsonNet Setup and the Wi-Fi icon does not appear lit on your LCD screen, make sure your product software was installed correctly. If necessary, reinstall your software.

Note: If you are using a 5 GHz wireless router, set the router to operate in dual band (2.4 GHz and 5 GHz) mode. See your router documentation for instructions.

Parent topic: [Solving Network Problems](#)

Related topics

[Wi-Fi Networking](#)

Cannot Print Over a Network

If you cannot print over a network, try these solutions:

- Make sure that your product is turned on.
- Make sure you install your product's network software as described in your product documentation.
- Check your network status on the LCD screen and verify that the network settings are correct. If the network status is **Disconnected**, check any cable connections and turn your product off and then on again.
- If you are using TCP/IP, make sure the product's IP address is set correctly for your network. If your network does not assign IP addresses using DHCP, set the IP address manually.
- Make sure your computer and product are both using the same wireless network.
- If network printing is slow, check your network status on the LCD screen and confirm the signal strength. If it is poor, place your product closer to your router or access point. Avoid placing your product near a microwave oven, 2.4 GHz cordless phone, or large metal object, such as a filing cabinet.

Note: If you are using a 5 GHz wireless router, set the router to operate in dual band (2.4 GHz and 5 GHz) mode. See your router documentation for instructions.

- Check to see if your wireless router or access point has an enabled Privacy Separator function that is preventing printing from a device over the network. See your router or access point documentation for instructions on disabling the Privacy Separator function.

- If you are connecting the product wirelessly via EpsonNet Setup and the Wi-Fi connection icon is not lit or does not appear on the product's LCD screen, make sure your product software was installed correctly. If necessary, reinstall your software.

Parent topic: [Solving Network Problems](#)

Related tasks

[Viewing the Network Status](#)

Related topics

[Wi-Fi Networking](#)

Solving Paper Problems

Check these sections if you have problems using paper with your product.

[Paper Feeding Problems](#)

[Paper Jam Problems Inside the Product](#)

[Paper Ejection Problems](#)

Parent topic: [Solving Problems](#)

Paper Feeding Problems

If you have problems feeding paper, try these solutions:

- If paper does not feed for printing, remove it. Then reload it in the rear paper feed against the left side. Slide the edge guide against the edge of the paper, making sure that the paper stack is not above the arrow mark on the edge guide.
- If multiple pages feed at once, remove the paper, fan the edges to separate the sheets, and reload it.
- If paper jams when you print on both sides of the paper, try loading fewer sheets.
- Make sure your paper meets the specifications for your product.
- Make sure the paper size and paper type settings on the control panel are correct.
- For best results, follow these guidelines:
 - Use new, smooth, high-quality paper that is not curled, creased, old, too thin, or too thick.
 - Load paper in the rear paper feed printable side up.
 - Follow any special loading instructions that came with the paper.

Parent topic: [Solving Paper Problems](#)

Related references[Paper Loading Capacity](#)[Paper Jam Problems Inside the Product](#)**Related tasks**[Loading Paper in the Paper Feed Slot](#)**Paper Jam Problems Inside the Product**

If paper has jammed inside the product, follow the steps below to clear the jam.

1. Cancel the print job, if necessary.
2. Remove any jammed paper from the rear paper feed slot.

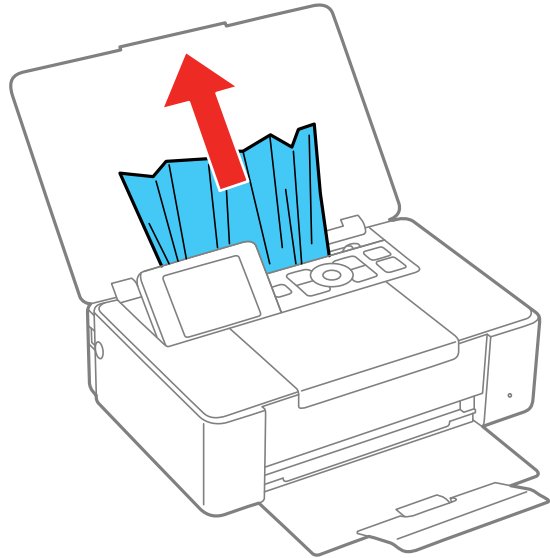

3. If necessary, carefully pull out any jammed paper from the front.

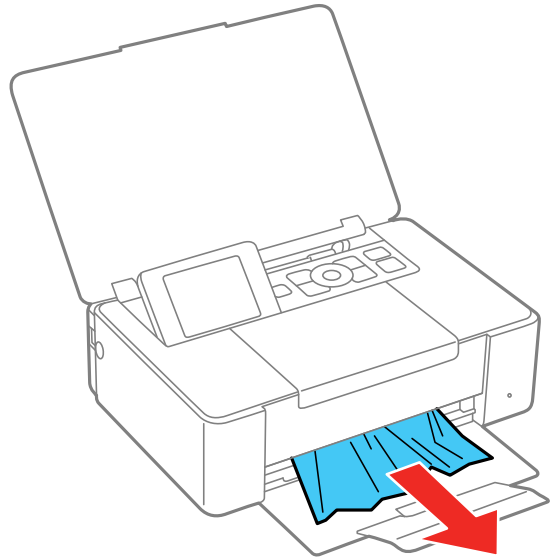

4. Open the inner cover and carefully remove any jammed paper.

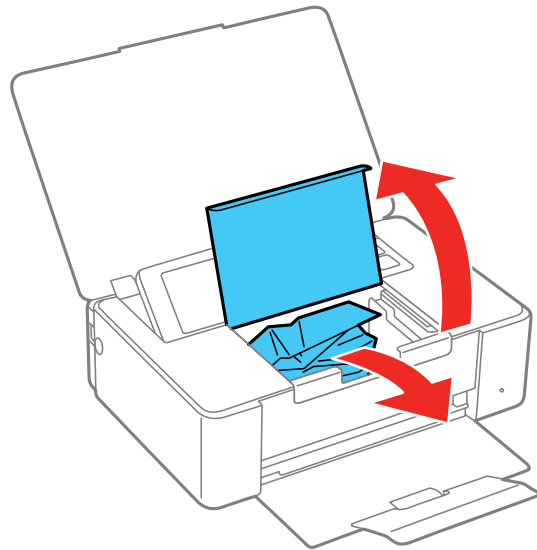

Caution: Do not touch the flat white cable inside the printer.

5. Close the inner cover.
6. Follow the prompts on the LCD screen to clear any error messages.

Parent topic: [Solving Paper Problems](#)

Paper Ejection Problems

If you have problems with paper ejecting properly, try these solutions:

- If paper does not eject fully, you may have set the wrong paper size. Cancel printing to eject the paper. Select the correct paper size when you reprint.
- If paper is wrinkled when it ejects, it may be damp or too thin. Load new paper and be sure to select the correct paper type setting when you reprint.

Parent topic: [Solving Paper Problems](#)

Related references

[Paper Jam Problems Inside the Product](#)

[Paper or Media Type Settings - Product Software](#)

[Paper Type Settings - Control Panel](#)

Related tasks

[Loading Paper in the Paper Feed Slot](#)

[Cancelling Printing Using a Product Button](#)

Solving Problems Printing from a Computer

Check these sections if you have problems while printing from your computer.

Note: When printing using AirPrint, the available print settings are different from those covered in this manual. See the Apple website for details.

[Nothing Prints](#)

[Product Icon Does Not Appear in Windows Taskbar](#)

[Printing is Slow](#)

Parent topic: [Solving Problems](#)

Nothing Prints

If you have sent a print job and nothing prints, try these solutions:

- Make sure your product is turned on.
- Make sure any interface cables are connected securely at both ends.
- If you connected your product to a USB hub, make sure it is a first-tier hub. If it still does not print, connect your product directly to your computer instead of the hub.
- Run a product check to see if a test page prints. If the test page prints, check to see if your product software is installed correctly.
- If you are printing a large image, the computer may not have enough memory. Print the image at a lower resolution or a smaller file size.
- In Windows, click **Print Queue** on the Maintenance tab in the printer settings window and check for the following:
 - Check for any stalled or paused print jobs. Cancel or unpause any jobs as necessary.
 - Open the Printer menu and make sure the product is not offline.
 - Open the Printer menu and set the product as the default printer, if necessary.
- In OS X, select **System Preferences** from the Apple menu or Dock, select **Print & Scan** or **Printers & Scanners**, then double-click your printer icon. Check to see if any jobs are paused. Cancel or resume any jobs as necessary.



Parent topic: [Solving Problems Printing from a Computer](#)

Related tasks

[Running a Product Check](#)

Product Icon Does Not Appear in Windows Taskbar

If you do not see your product icon in the Windows taskbar, first try restarting your computer. If that does not work, try this solution:

1. Do one of the following:
 - **Windows 8.x:** Navigate to the **Apps** screen and select **Control Panel > Hardware and Sound > Devices and Printers**.
 - **Windows 7:** Click  and select **Devices and Printers**.
 - **Windows Vista:** Click , select **Control Panel**, and click **Printer** under **Hardware and Sound**.

- **Windows XP:** Click **Start** and select **Printers and Faxes**. (Or open the **Control Panel**, select **Printers and Other Hardware**, if necessary, and **Printers and Faxes**.)
2. Right-click your product name, select **Printing Preferences**, and select your product name again if necessary.
 3. Click the **Maintenance** tab.
 4. Click the **Extended Settings** button.
 5. Select **Enable EPSON Status Monitor 3**, then click **OK**.
 6. Click the **Monitoring Preferences** button.
 7. Click the checkbox for the option that adds the shortcut icon to the taskbar.
 8. Click **OK** to close the open program windows.

Parent topic: [Solving Problems Printing from a Computer](#)

Printing is Slow

If printing becomes slow, try these solutions:

- Make sure your system meets the requirements for your operating system. If you are printing a high-resolution image, you may need more than the minimum requirements. If necessary, increase your system's memory.
- If you are using Windows 7, close the **Devices and Printers** window before you print.
- Clear space on your hard drive or run a defragmentation utility to free up existing space.
- Close any programs you are not using when you print.
- If your product is connected to a USB hub, connect it directly to your computer instead.
- If printing becomes slower after printing continuously for a long time, the product may have automatically slowed down to protect the print mechanism from overheating or becoming damaged. Let the product rest with the power on for 30 minutes, then try printing again.

For the fastest printing, select the following settings in your product software:

- Make sure the paper type setting matches the type of paper you loaded.
- Turn on any high speed settings in your product software.
- Select a lower print quality setting.
- **Windows:** Click the **Maintenance** or **Utility** tab, select **Extended Settings** or **Speed and Progress**, and select the following settings:
 - **Always Spool RAW Datatype**

- **Page Rendering Mode**
- **Print as Bitmap**

Parent topic: [Solving Problems Printing from a Computer](#)

Related references

[Windows System Requirements](#)

[OS X System Requirements](#)

[Paper or Media Type Settings - Product Software](#)

Related tasks

[Selecting Basic Print Settings - Windows](#)

[Selecting Extended Settings - Windows](#)

[Selecting Basic Print Settings - OS X](#)

[Selecting Printing Preferences - OS X](#)

Solving Page Layout and Content Problems

Check these sections if you have problems with the layout or content of your printed pages.

Note: When printing using AirPrint, the available print settings are different from those covered in this manual. See the Apple website for details.

[Inverted Image](#)

[Too Many Copies Print](#)

[Blank Pages Print](#)

[Incorrect Margins on Printout](#)

[Border Appears on Borderless Prints](#)

[Incorrect Characters Print](#)

[Incorrect Image Size or Position](#)

[Slanted Printout](#)

Parent topic: [Solving Problems](#)

Inverted Image

If your printed image is inverted unexpectedly, try these solutions:

- Turn off any mirror or inversion settings in your printing application.

- Turn off the **Mirror Image**, **Flip horizontally**, or **Reverse page orientation** settings in your printer software. (This option has different names, depending on your operating system version.)

Note: Leave these options turned on when you print on Epson Iron-on Cool Peel Transfer paper, if available for your product.

Parent topic: [Solving Page Layout and Content Problems](#)

Related tasks

[Selecting Additional Layout and Print Options - Windows](#)

[Selecting Basic Print Settings - OS X](#)

Too Many Copies Print

Make sure that the **Copies** setting in your printing program or printer software is not set for multiple copies.

Parent topic: [Solving Page Layout and Content Problems](#)

Blank Pages Print

If blank pages print unexpectedly, try these solutions:

- Make sure you selected the correct paper size settings in your printing program and printer software.
- If a blank page exists in a document you are printing and you want to skip printing it, select the **Skip Blank Page** setting in your printer software.
- Run a print head nozzle check to see if any of the nozzles are clogged. Then clean the print head, if necessary.
- Make sure your product is selected as the printer in your printing program.

Parent topic: [Solving Page Layout and Content Problems](#)

Related concepts

[Print Head Nozzle Check](#)

[Print Head Cleaning](#)

Related tasks

[Selecting Basic Print Settings - Windows](#)

[Selecting Extended Settings - Windows](#)

[Selecting Basic Print Settings - OS X](#)

[Selecting Printing Preferences - OS X](#)

Incorrect Margins on Printout

If your printed page has incorrect margins, try these solutions:

- Make sure you selected the correct paper size settings in your printing program and printer software.
- Make sure you selected the correct margins for your paper size in your printing program.
- Make sure your paper is positioned correctly for feeding into the printer.

You can use the preview option in your printer software to check your margins before you print.

Parent topic: [Solving Page Layout and Content Problems](#)

Related tasks

[Loading Paper in the Paper Feed Slot](#)

[Selecting Basic Print Settings - Windows](#)

[Selecting Basic Print Settings - OS X](#)

[Selecting Page Setup Settings - OS X](#)

Border Appears on Borderless Prints

If you see a border on borderless prints, try these solutions:

- Make sure you are printing on a compatible borderless paper type and size.

Note: For custom paper sizes, make sure you select a supported borderless page width.

- **Windows:** Make sure you selected the **Borderless** setting in your printer software.
- **OS X:** Make sure you selected the **Borderless** checkbox or a paper size with a **Borderless** option in your printer software.
- Adjust the **Expansion** setting to adjust the amount of image expansion on the edges of borderless prints.
- Make sure the image size and the paper size are set correctly; if the image is small, the enlargement may not be enough to cover the paper.

Parent topic: [Solving Page Layout and Content Problems](#)

Related references

[Borderless Paper Type Compatibility](#)

Related tasks

[Selecting Basic Print Settings - Windows](#)

[Selecting Basic Print Settings - OS X](#)

[Selecting Page Setup Settings - OS X](#)

Incorrect Characters Print

If incorrect characters appear in your prints, try these solutions before reprinting:

- Make sure any cables are securely connected at both ends.
- In Windows, delete all jobs from the Windows Spooler. Click **Print Queue** on the Maintenance tab in the printer settings window, and cancel any stalled print jobs.
- If your product is connected to a USB hub, connect it directly to your computer instead.
- If your computer entered sleep mode the last time you printed, the next print job after your computer exits sleep mode may contain garbled characters. Print your document again.
- If incorrect characters still appear in your prints, try connecting your product using a different cable.

Parent topic: [Solving Page Layout and Content Problems](#)

Related tasks

[Selecting Basic Print Settings - Windows](#)

[Selecting Basic Print Settings - OS X](#)

[Selecting Page Setup Settings - OS X](#)

Incorrect Image Size or Position

If your printed image is the wrong size or in the wrong position, try these solutions:

- Make sure you selected the correct paper size and layout settings in your printing program and printer software.
- Make sure you selected the correct paper size on the control panel.
- Make sure your paper is positioned correctly for feeding into the printer.

You can use the preview option in your printer software to check your margins before you print.

Parent topic: [Solving Page Layout and Content Problems](#)

Related tasks

[Loading Paper in the Paper Feed Slot](#)

[Selecting Basic Print Settings - Windows](#)

[Selecting Basic Print Settings - OS X](#)

[Selecting Page Setup Settings - OS X](#)

Slanted Printout

If your printouts are slanted, try these solutions:

- Slide the edge guide against the edge of the paper.
- Select a higher print quality setting in your printer software.
- Turn off any high speed settings in your product software.
- Align the print head.
- Make sure the product is not printing while tilted or at an angle.

Parent topic: [Solving Page Layout and Content Problems](#)

Related tasks

[Loading Paper in the Paper Feed Slot](#)

[Selecting Basic Print Settings - Windows](#)

[Selecting Basic Print Settings - OS X](#)

Solving Print Quality Problems

Check these sections if your printouts have problems with print quality, but your image looks fine on your computer screen.

Note: When printing using AirPrint, the available print settings are different from those covered in this manual. See the Apple website for details.

[White or Dark Lines in Printout](#)

[Blurry or Smearred Printout](#)

[Faint Printout or Printout Has Gaps](#)

[Grainy Printout](#)

[Incorrect Colors](#)

Parent topic: [Solving Problems](#)

White or Dark Lines in Printout

If you notice white or dark lines in your prints (also called banding), try these solutions before you reprint:

- Run a nozzle check to see if any of the print head nozzles are clogged. Then clean the print head, if necessary.
- Make sure the paper type setting matches the type of paper you loaded.

- Make sure you loaded the printable side of the paper correctly for your product.
- Turn off any high speed settings in your product software.
- Align the print head.
- You may need to replace the ink cartridge.

Parent topic: [Solving Print Quality Problems](#)

Related concepts

[Print Head Nozzle Check](#)

[Print Head Cleaning](#)

[Print Head Alignment](#)

Related references

[Paper or Media Type Settings - Product Software](#)

[Paper Type Settings - Control Panel](#)

Related tasks

[Loading Paper in the Paper Feed Slot](#)

[Selecting Additional Layout and Print Options - Windows](#)

[Selecting Printing Preferences - OS X](#)

Related topics

[Replacing the Ink Cartridge](#)

Blurry or Smearred Printout

If your printouts are blurry or smearred, try these solutions:

- Make sure your paper is not damp, curled, old, or loaded incorrectly in your product.
- Use a support sheet with special paper, or load special paper one sheet at a time.
- Make sure your paper meets the specifications for your product.
- Use Epson papers to ensure proper saturation and absorption of genuine Epson inks.
- Make sure the paper type setting in your product software matches the type of paper you loaded.
- Make sure you loaded the printable side of the paper correctly for your product.
- Remove each sheet from the output tray as it is printed.
- Avoid handling printouts on glossy paper right after printing to allow the ink to set.
- Turn off any high speed settings in your product software.

- If you print on both sides of a sheet of paper, smudges may appear on the reverse side of heavily saturated or dark images. If one side of a sheet will contain a lighter image or text, print that side first. Make sure the ink has dried before reloading the paper to print on the other side.
- Run a nozzle check to see if any of the print head nozzles are clogged. Then clean the print head, if necessary.
- Align the print head.
- Clean the paper path.

Note: Your product will not operate properly while tilted at an angle. Place it on a flat, stable surface that extends beyond the base of the product in all directions.

Parent topic: [Solving Print Quality Problems](#)

Related concepts

[Print Head Nozzle Check](#)

[Print Head Cleaning](#)

[Print Head Alignment](#)

Related references

[Available Epson Papers](#)

[Paper Specifications](#)

Related tasks

[Selecting Basic Print Settings - Windows](#)

[Selecting Additional Layout and Print Options - Windows](#)

[Selecting Extended Settings - Windows](#)

[Selecting Basic Print Settings - OS X](#)

[Selecting Printing Preferences - OS X](#)

[Cleaning the Paper Path](#)

[Loading Paper in the Paper Feed Slot](#)

Faint Printout or Printout Has Gaps

If your printouts are faint or have gaps, try these solutions:

- Run a nozzle check to see if any of the print head nozzles are clogged. Then clean the print head, if necessary.
- The ink cartridge may be old or low on ink, and you may need to replace it.

- Make sure the paper type setting matches the type of paper you loaded.
- Make sure your paper is not damp, curled, old, or loaded incorrectly in your product.
- Align the print head.
- Clean the paper path.

Parent topic: [Solving Print Quality Problems](#)

Related concepts

[Print Head Nozzle Check](#)

[Print Head Cleaning](#)

[Print Head Alignment](#)

Related references

[Paper or Media Type Settings - Product Software](#)

Related tasks

[Cleaning the Paper Path](#)

[Loading Paper in the Paper Feed Slot](#)

Related topics

[Replacing the Ink Cartridge](#)

Grainy Printout

If your printouts are grainy, try these solutions:

- Make sure you loaded the printable side of the paper correctly for your product.
- Select a higher print quality setting and turn off any high speed settings in your product software.
- Run a nozzle check to see if any of the print head nozzles are clogged. Then clean the print head, if necessary.
- Align the print head.
- You may need to increase the image resolution or print a smaller size; see your software documentation.

Note: Images from the Internet may be low resolution and not result in a high quality printout.

- If you enlarged the image in an image-editing program, you need to increase the resolution setting to retain a high image quality. Increase the resolution by the same amount you increased the image size.

For example, if the resolution is 300 dpi (dots per inch) and you will double the image size later, change the resolution setting to 600 dpi.

Note: Higher resolution settings result in larger file sizes, which take longer to process and print. Consider the limitations of your computer system when selecting a resolution, and select the lowest possible resolution that produces acceptable quality to keep file sizes manageable.

Parent topic: [Solving Print Quality Problems](#)

Related concepts

[Print Head Nozzle Check](#)

[Print Head Cleaning](#)

[Print Head Alignment](#)

Related tasks

[Selecting Basic Print Settings - Windows](#)

[Selecting Additional Layout and Print Options - Windows](#)

[Selecting Basic Print Settings - OS X](#)

[Selecting Printing Preferences - OS X](#)

Incorrect Colors

If your printouts have incorrect colors, try these solutions:

- Make sure the paper type setting matches the paper you loaded.
- Make sure the **Black/Grayscale** or **Grayscale** setting is not selected in your printer software.
- Run a nozzle check to see if any of the print head nozzles are clogged. Then clean the print head, if necessary.
- The ink cartridge may be old or low on ink, and you may need to replace it.
- After you print, the colors in your printout need time to set as the ink dries. During this time, the colors may look different than you expect. To speed up drying time, do not stack your printouts on top of each other.
- Your printed colors can never exactly match your on-screen colors. However, you can use a color management system to get as close as possible. Try using the color management options in your printer software.
- For best results, use genuine Epson ink and paper.

Parent topic: [Solving Print Quality Problems](#)

Related concepts

[Print Head Nozzle Check](#)

[Print Head Cleaning](#)

Related tasks

[Selecting Basic Print Settings - Windows](#)

[Selecting Additional Layout and Print Options - Windows](#)

[Selecting Basic Print Settings - OS X](#)

[Managing Color - OS X](#)

Related topics

[Replacing the Ink Cartridge](#)

Solving Memory Card Problems

Check these solutions if you have problems using memory cards with your product.

[Memory Card Does Not Fit Into a Slot](#)

[Cannot View or Print Photos from a Memory Card or Device](#)

[Cannot Transfer Photos To or From a Memory Card or Device](#)

Parent topic: [Solving Problems](#)

Memory Card Does Not Fit Into a Slot

If a memory card does not fit properly in a slot, do not force it in. You may need to use an adapter with your memory card.

Parent topic: [Solving Memory Card Problems](#)

Related references

[Memory Card Types](#)

Related tasks

[Inserting a Memory Card](#)

Cannot View or Print Photos from a Memory Card or Device

If you cannot view or print photos from a memory card or USB device inserted in your product, try these solutions:

- Make sure your memory card or device is compatible with the product.
- Make sure the files on your memory card or device are in the correct format.

- If you have too many photos on your memory card or device, you may not see all the photos you expect or may be prompted to select a group of photos by date. Reduce the number of photos on your card or select one group of photos at a time. Check the specifications for the maximum number of photos.

Parent topic: [Solving Memory Card Problems](#)

Related references

[Memory Card Types](#)

[Memory Card File Specifications](#)

[USB Device File Specifications](#)

Related tasks

[Inserting a Memory Card](#)

Related topics

[Printing from a Memory Card](#)

[Using an External Device with Your Product](#)

Cannot Transfer Photos To or From a Memory Card or Device

If you have problems transferring photos to or from a memory card, try these solutions:

- Make sure your memory card or device is compatible with the product.
- Make sure your product is set up wirelessly and connected to the same network as your computer.
- If you are transferring photos to a memory card, check the memory card's write-protect tab to make sure it is set to allow writing to the card.

Parent topic: [Solving Memory Card Problems](#)

Related references

[Memory Card Types](#)

[Memory Card File Specifications](#)

[USB Device File Specifications](#)

Related tasks

[Transferring Photos from a Memory Card to Your Computer](#)

Uninstall Your Product Software

If you have a problem that requires you to uninstall and re-install your software, follow the instructions for your operating system.

[Uninstalling Printing Software - Windows](#)

[Uninstalling Product Software - OS X](#)

Parent topic: [Solving Problems](#)

Uninstalling Printing Software - Windows

You can uninstall and then re-install your printer software to solve certain problems.

1. Turn off the product.
2. Disconnect any interface cables.
3. Do one of the following:
 - **Windows 8.x:** Navigate to the **Apps** screen and select **Control Panel > Programs > Programs and Features**. Select the uninstall option for your Epson product, then select **Uninstall/Change**.

Note: If you see a **User Account Control** window, click **Yes** or **Continue**.

In the next window, select your product, if necessary, and click **OK**. Then follow any on-screen instructions.

- **Windows (other versions):** Click  or **Start**, and select **All Programs** or **Programs**. Select **Epson**, select your product, then click **EPSON Printer Software Uninstall**.

Note: If you see a **User Account Control** window, click **Yes** or **Continue**.

In the next window, select your product, if necessary, and click **OK**. Then follow any on-screen instructions.

4. Restart your computer, then re-install your software.

Note: If you find that re-installing your product software does not solve a problem, contact Epson.

Parent topic: [Uninstall Your Product Software](#)

Uninstalling Product Software - OS X

In most cases, you do not need to uninstall your product software before re-installing it. However, you can download the Uninstaller utility from the Epson support website to uninstall your product software as described here.

Note: If you find that re-installing your product software does not solve a problem, contact Epson.

1. To download the Uninstaller utility, visit the Epson download site ([U.S. downloads](#) or [Canadian downloads](#)).
2. Follow the instructions on the screen to install the Uninstaller utility.
3. Quit all applications currently running on your Mac.
4. Double-click the **Uninstaller** icon.
5. Select the checkbox for each software program you want to uninstall.
6. Click **Uninstall**.
7. Follow the on-screen instructions to uninstall the software.
8. To reinstall your product software, see the *Start Here* sheet for instructions.

Note: If you uninstall the printer driver and your product name remains in the **Print & Fax, Print & Scan,** or **Printers & Scanners** window, select your product name and click the – (remove) icon to remove it.

Parent topic: [Uninstall Your Product Software](#)

Where to Get Help

If you need to contact Epson for technical support services, use the following support options.

Internet Support

Visit Epson's support website at [epson.com/support](#) (U.S.) or [epson.ca/support](#) (Canada) for solutions to common problems. You can download drivers and documentation, get FAQs and troubleshooting advice, or e-mail Epson with your questions.

Speak to a Support Representative

Before you call Epson for support, please have the following information ready:

- Product name
- Product serial number (located on a label on the product)
- Proof of purchase (such as a store receipt) and date of purchase
- Computer configuration
- Description of the problem

Then call:

- U.S.: (562) 276-7282, 6 AM to 8 PM, Pacific Time, Monday through Friday, and 7 AM to 4 PM, Pacific Time, Saturday
- Canada: (905) 709-2567, 6 AM to 8 PM, Pacific Time, Monday through Friday, and 7 AM to 4 PM, Pacific Time, Saturday

Days and hours of support are subject to change without notice. Toll or long distance charges may apply.

Purchase Supplies and Accessories

You can purchase genuine Epson ink and paper at [epson.com/ink3](https://www.epson.com/ink3) (U.S. sales) or [epson.ca](https://www.epson.ca) (Canadian sales). You can also purchase supplies from an Epson authorized reseller. To find the nearest one, call 800-GO-EPSON (800-463-7766).

Parent topic: [Solving Problems](#)

Technical Specifications

These sections list the technical specifications for your product.

Note: Epson offers a recycling program for end of life products. Please go to [this site](#) for information on how to return your products for proper disposal.

[Windows System Requirements](#)

[OS X System Requirements](#)

[Paper Specifications](#)

[Printable Area Specifications](#)

[Ink Cartridge Specifications](#)

[Memory Card Specifications](#)

[External USB Device Specifications](#)

[Dimension Specifications](#)

[Electrical Specifications](#)

[Environmental Specifications](#)

[Interface Specifications](#)

[Network Interface Specifications](#)

[Safety and Approvals Specifications](#)

Windows System Requirements

To use your product and its software, your computer should use one of these Microsoft operating systems:

- Windows 10
- Windows 8.x
- Windows 7
- Windows Vista
- Windows XP Professional x64 Edition
- Windows XP SP3

Note: Visit Epson's support website at epson.com/support (U.S.) or epson.ca/support (Canada) for the latest in compatibility and drivers for your product.

Parent topic: [Technical Specifications](#)

OS X System Requirements

To use your product and its software, your Mac should use one of these operating systems:

- OS X 10.10.x
- OS X 10.9.x
- OS X 10.8.x
- OS X 10.7.x
- OS X 10.6.8

Note: Visit Epson's support website at epson.com/support (U.S.) or epson.ca/support (Canada) for the latest in compatibility and drivers for your product.

Parent topic: [Technical Specifications](#)

Paper Specifications

Note: Since the quality of any particular brand or type of paper may be changed by the manufacturer at any time, Epson cannot guarantee the quality of any non-Epson brand or type of paper. Always test a sample of paper stock before purchasing large quantities or printing large jobs.

Single-sheets

Size	A5 (5.8 × 8.2 inches [148 × 210 mm]) A6 (4.1 × 5.8 inches [105 × 148 mm]) 4 × 6 inches (102 × 152 mm) 5 × 7 inches (127 × 178 mm) 3.5 × 5 inches (89 × 127 mm) 16:9 wide (4 × 7.1 inches [102 × 181 mm])
Paper types	Plain paper and paper distributed by Epson
Thickness	0.002 inch (0.05 mm) to 0.02 inch (0.6 mm) 0.003 inch (0.08 mm) to 0.004 inch (0.11 mm) for plain paper

Plain paper weight 17 lb (64 g/m²) to 24 lb (90 g/m²)

Envelopes

Size No. 10 (4.1 × 9.5 inches [105 × 241 mm])

Paper types Plain bond paper

Weight 20 lb (75 g/m²) to 24 lb (90 g/m²)

Parent topic: [Technical Specifications](#)

Printable Area Specifications

Note: Print quality may decline in the shaded areas shown here due to the printer mechanism.

Single sheets - normal printing

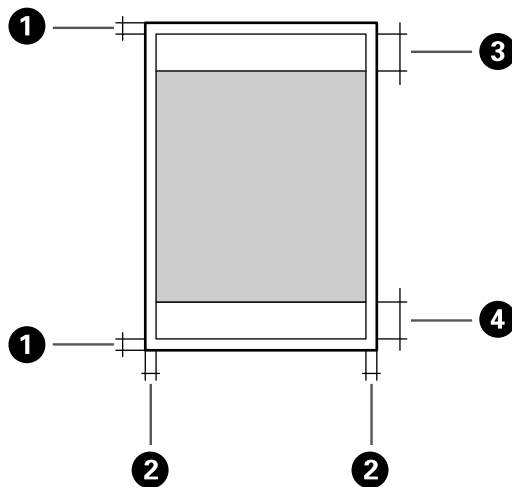

1 Margin: 0.12 inch (3 mm) minimum

2 A5 (5.8 × 8.2 inches [148 × 210 mm]) paper: 0.39 inch (10.0 mm)

Paper smaller than A5 (5.8 × 8.2 inches [148 × 210 mm]): 0.12 inch (3.0 mm)

- 3 Reduced print quality area/top: 1.46 inches (37 mm) minimum
- 4 Reduced print quality area/bottom: 1.56 inches (39 mm) minimum

Single sheets - borderless printing

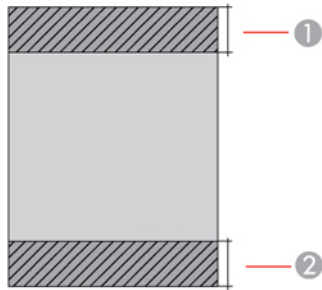

- 1 Reduced print quality area/top: 1.57 inches (40 mm) minimum
- 2 Reduced print quality area/bottom: 1.65 inches (42 mm) minimum

Envelopes

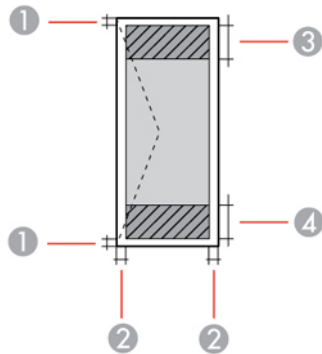

- 1 Left/right margins: 0.12 inch (3 mm) minimum
- 2 Top/bottom margins: 0.20 inch (5 mm) minimum
- 3 Reduced print quality area/right: 0.71 inches (18 mm) minimum

4 Reduced print quality area/left: 1.46 inches (37 mm) minimum

Parent topic: [Technical Specifications](#)

Ink Cartridge Specifications

Note: We recommend that you use genuine Epson cartridges and do not refill them. The use of other products may affect your print quality and could result in printer damage.

The cartridge included with the printer is designed for printer setup and not for resale. After some ink is used for charging, the rest is available for printing. Yields vary considerably based on images printed, print settings, paper type, frequency of use, and temperature. For print quality, a variable amount of ink remains in the cartridge after the "replace cartridge" indicator comes on.

Color	Cyan, Magenta, Yellow, Black
Cartridge life	Opened package: 6 months Unopened package: do not use if the date on the package has expired
Temperature	Storage: -22 to 104 °F (-30 to 40 °C) 1 month at 104 °F (40 °C) Ink freezes at 3.2 °F (-16 °C) Ink thaws and is usable after 3 hours at 77 °F (25 °C)

Note: For best printing results, use up a cartridge within 6 months of opening the package.

Parent topic: [Technical Specifications](#)

Related concepts

[Purchase Epson Ink Cartridges](#)

Memory Card Specifications

Note: Cards marked with an asterisk (*) require an adapter; consult your adapter documentation for details on using it.

Compatible types/Maximum capacities	SD: 2GB SDHC: 32GB SDXC: 64GB miniSD*: 2GB miniSDHC*: 32GB microSD*: 2GB microSDHC*: 32GB microSDXC*: 64GB
Voltage requirements	3.3 V type, dual voltage type (3.3 V and 5V); supply voltage 3.3 V Maximum current: 200 mA

Parent topic: [Technical Specifications](#)

External USB Device Specifications

Do not use devices with the following requirements:

- Dedicated driver
- Security settings, such as password or encryption, etc.
- Built-in USB hub

Note: Use only external storage devices with independent AC power sources. External storage devices that are powered via USB are not recommended. Epson cannot guarantee the operation of externally connected devices.

CD-ROM/CD-R drive	700MB maximum capacity CD-RW is not supported
DVD-ROM/DVD-R drive	4.7GB maximum capacity DVD+R, DVD±RW, DVD-RAM, and Blu-ray Disc are not supported
Magneto-optical drive	1.3GB
Hard disk and USB flash drives	2TB Formatted in FAT, FAT32, or exFAT.

Parent topic: [Technical Specifications](#)

Dimension Specifications

Height	Stored: 3.3 inches (85 mm) Printing: 7.9 inches (201 mm)
Width	Stored: 9.8 inches (249 mm) Printing: 9.8 inches (249 mm)
Depth	Stored: 6.9 inches (176 mm) Printing: 15.1 inches (383 mm)
Weight (without ink cartridge and AC adapter)	4.0 lb (1.8 kg)

Parent topic: [Technical Specifications](#)

Electrical Specifications

Printer

Rated DC input voltage	DC24V
Rated DC input current	0.9A
Power consumption (USB Connection)	Printing: Approximately 12 W (ISO/IEC24712) Ready mode: Approximately 6 W Sleep mode: Approximately 1.5 W Power off mode: Approximately 0.2 W

AC Adapter

AC adapter model	A461H
Input	AC100–240V, 1A, 50–60Hz
Output	DC24V, 1A

Parent topic: [Technical Specifications](#)

Environmental Specifications

Temperature	Operating: 50 to 95 °F (10 to 35 °C) Storage: –4 to 104 °F (–20 to 40 °C) 1 month at 104 °F (40 °C)
Humidity (without condensation)	Operating: 20 to 80% RH Storage: 5 to 85% RH

Parent topic: [Technical Specifications](#)

Interface Specifications

For computer	Hi-Speed USB
For external USB and PictBridge device	Hi-Speed USB

Note: Epson cannot guarantee the operation of externally connected devices.

Parent topic: [Technical Specifications](#)

Network Interface Specifications

Standards	IEEE 802.11 b/g/n (complies with either IEEE 802.11 b/g or IEEE 802.11 b/g/n, depending on purchase location)
Security	WEP (64/128 bit) WPA2-PSK (AES); complies with WPA2 with support for WPA/WPA2 Personal
Frequency range	2.4 GHz

Coordination modes

Infrastructure mode

Ad hoc mode (not supported for IEEE 802.11n)

Wi-Fi Direct (not supported for IEEE 802.11b)

Note: Simple AP mode is compatible with Wi-Fi infrastructure mode.**Parent topic:** [Technical Specifications](#)

Safety and Approvals Specifications

United States

Safety: UL60950-1

EMC: FCC part 15 Subpart B class B

Canada

Safety: CAN/CSA C22.2 No. 60950-1

EMC: CAN/CSA-CEI/IEC CISPR 22 Class B

This equipment contains the following wireless module:

- Manufacturer: Askey Computer Corporation.
- Type: WLU6320-D69 (RoHS)

This product conforms to Part 15 of FCC Rules and RSS-210 of the IC Rules. Epson cannot accept responsibility for any failure to satisfy the protection requirements resulting from a non-recommended modification of the product. Operation is subject to the following two conditions: (1) this device may not cause harmful interference, and (2) this device must accept any interference received, including interference that may cause undesired operation of the device.

To prevent radio interference to the licensed service, this device is intended to be operated indoors and away from windows to provide maximum shielding. Equipment (or its transmit antenna) that is installed outdoors is subject to licensing.

This equipment complies with FCC/IC radiation exposure limits set forth for an uncontrolled environment and meets the FCC radio frequency (RF) Exposure Guidelines in Supplement C to OET65 and RSS-102 of the IC radio frequency (RF) Exposure rules. This equipment should be installed and operated so that the radiator is kept at least 7.9 inches (20 cm) or more away from a person's body (excluding extremities: hands, wrists, feet and ankles).

Parent topic: [Technical Specifications](#)

Notices

Check these sections for important notices about your product.

Note: Epson offers a recycling program for end of life products. Please go to [this site](#) for information on how to return your products for proper disposal.

[General Printer Safety Instructions](#)

[FCC Compliance Statement](#)

[Trademarks](#)

[Copyright Notice](#)

General Printer Safety Instructions

- Be sure to follow all warnings and instructions marked on the printer.
- Use only the AC adapter that comes with the printer and do not use it with other equipment. Use of other cords with this product or use of the AC adapter with other products may cause fires or shock.
- Use only the type of power source indicated on the AC adapter's label.
- Place the printer near a wall outlet where the plug can be easily unplugged.
- Avoid plugging the printer into an outlet on the same circuit as a photo copier or air control system that regularly switches on and off, or on an outlet controlled by a wall switch or timer.
- Do not let the power cord become damaged or frayed.
- If you use an extension cord with the printer, make sure the total ampere rating of the devices plugged into the extension cord does not exceed the cord's ampere rating. Also, make sure the total ampere rating of all devices plugged into the wall outlet does not exceed the wall outlet's ampere rating.
- Always turn off the printer using the power button, and wait until the power light stops flashing before unplugging the printer or cutting off power to the electrical outlet.
- Place the printer on a flat, stable surface that extends beyond its base in all directions. It will not operate properly if it is tilted or at an angle.
- Leave enough space in front of the printer for the paper to be fully ejected.
- Avoid locations that are subject to rapid changes in heat or humidity, shocks or vibrations, or dust.
- Do not place the printer near a radiator or heating vent or in direct sunlight.

- Leave enough room around the printer for sufficient ventilation. Do not block or cover openings in the case or insert objects through the slots.
- Keep the printer away from potential sources of electromagnetic interference, such as loudspeakers or the base units of cordless telephones.
- Do not touch the flat white cable inside the printer.
- Do not move the print head by hand; this may damage the printer.
- Do not spill liquid on the printer or AC adapter and do not handle the printer or AC adapter with wet hands.
- Do not use aerosol products that contain flammable gases inside or around the printer. Doing so may cause fire.
- Except as specifically explained in your documentation, do not attempt to service the printer yourself.
- Unplug the printer and refer servicing to qualified service personnel under the following conditions: if the power cord or plug is damaged; if liquid has entered the product; if the product has been dropped or the case damaged; if the product does not operate normally or exhibits a distinct change in performance. Adjust only those controls that are covered by the operating instructions.
- If damage occurs to the plug, replace the cord set or consult a qualified electrician. If there are fuses in the plug, make sure you replace them with fuses of the correct size and rating.
- Leave the ink cartridge installed. Removing the cartridge can dehydrate the print head and may prevent the printer from printing.
- Before transporting the printer, make sure that the print head is in the home (far right) position and the ink cartridges are in place.
- When storing or transporting the printer, do not tilt it, stand it on its side, or turn it upside down; otherwise ink may leak.

[Ink Cartridge Safety Instructions](#)

[LCD Screen Safety Instructions](#)

[Wireless Connection Safety Instructions](#)

Parent topic: [Notices](#)

Ink Cartridge Safety Instructions

- Keep ink cartridges out of the reach of children and do not drink the ink.
- Be careful when you handle used ink cartridges; there may be ink remaining around the ink supply port. If ink gets on your skin, wash it off with soap and water. If it gets in your eyes, flush them immediately with water.

- Do not put your hand inside the product or touch any cartridges during printing.
- Install a new ink cartridge immediately after removing an expended one. Leaving the cartridge uninstalled can dry out the print head and may prevent the product from printing.
- Insert the ink cartridge in the correct direction; otherwise you may damage the product.
- Do not touch the green IC chip on the side of the cartridge. This may prevent normal operation.
- Do not shake cartridges after opening their packages; this can cause them to leak.
- If you remove an ink cartridge for later use, recap the ink cartridge using the cap that came with it to prevent the ink from drying out and to protect the surrounding area from getting smeared by ink.
- Use an ink cartridge before the date printed on its package.
- Do not dismantle an ink cartridge. This could damage the print head.
- Store ink cartridges in a cool, dark place.
- After bringing an ink cartridge inside from a cold storage site, allow it to warm up at room temperature for at least three hours before using it.

Parent topic: [General Printer Safety Instructions](#)

LCD Screen Safety Instructions

- Use only a dry, soft cloth to clean the LCD screen. Do not use liquid or chemical cleansers.
- If the LCD screen is damaged, contact Epson. If the liquid crystal solution gets on your hands, wash them thoroughly with soap and water. If the liquid crystal solution gets into your eyes, flush them immediately with water. If discomfort or vision problems remain after a thorough flushing, see a doctor immediately.
- Do not press too hard on the LCD screen.
- Do not use a pointy or sharp object, such as a pen or your fingernail, to operate the LCD screen.

Parent topic: [General Printer Safety Instructions](#)

Wireless Connection Safety Instructions

Radio waves from this product may adversely affect the operation of medical equipment or automatically controlled devices, such as pacemakers, automatic doors or fire alarms. When using this product near such devices or inside a medical facility, follow the directions from authorized staff members at the facility, and follow all posted warnings and directions on the device to avoid causing an accident.

Parent topic: [General Printer Safety Instructions](#)

FCC Compliance Statement

For United States Users

This equipment has been tested and found to comply with the limits for a Class B digital device, pursuant to Part 15 of the FCC Rules. These limits are designed to provide reasonable protection against harmful interference in a residential installation. This equipment generates, uses, and can radiate radio frequency energy and, if not installed and used in accordance with the instructions, may cause harmful interference to radio or television reception. However, there is no guarantee that interference will not occur in a particular installation. If this equipment does cause interference to radio and television reception, which can be determined by turning the equipment off and on, the user is encouraged to try to correct the interference by one or more of the following measures:

- Reorient or relocate the receiving antenna.
- Increase the separation between the equipment and receiver.
- Connect the equipment into an outlet on a circuit different from that to which the receiver is connected.
- Consult the dealer or an experienced radio/TV technician for help.

WARNING

The connection of a non-shielded equipment interface cable to this equipment will invalidate the FCC Certification or Declaration of this device and may cause interference levels which exceed the limits established by the FCC for this equipment. It is the responsibility of the user to obtain and use a shielded equipment interface cable with this device. If this equipment has more than one interface connector, do not leave cables connected to unused interfaces. Changes or modifications not expressly approved by the manufacturer could void the user's authority to operate the equipment.

For Canadian Users

CAN ICES-3(B)/NMB-3(B)

Parent topic: [Notices](#)

Trademarks

EPSON® is a registered trademark, EPSON Exceed Your Vision is a registered logomark, and Epson Connect™ is a trademark of Seiko Epson Corporation.

Epson iPrint™ and Remote Print™ are trademarks of Seiko Epson Corporation.

Apple, iPad, iPhone, iPod touch, Mac, and OS X are trademarks of Apple Inc., registered in the U.S. and other countries. AirPrint and the AirPrint logo are trademarks of Apple Inc.

Google® is a registered trademark and Android™, Chromebook™, Gmail™, Google Chrome™, Google Cloud Print™, and Google Drive™ are trademarks of Google Inc.

Wi-Fi Direct® is a registered trademark of Wi-Fi Alliance®.

General Notice: Other product names used herein are for identification purposes only and may be trademarks of their respective owners. Epson disclaims any and all rights in those marks.



Parent topic: [Notices](#)

Copyright Notice

All rights reserved. No part of this publication may be reproduced, stored in a retrieval system, or transmitted in any form or by any means, electronic, mechanical, photocopying, recording, or otherwise, without the prior written permission of Seiko Epson Corporation. The information contained herein is designed only for use with this Epson product. Epson is not responsible for any use of this information as applied to other products.

Neither Seiko Epson Corporation nor its affiliates shall be liable to the purchaser of this product or third parties for damages, losses, costs, or expenses incurred by purchaser or third parties as a result of: accident, misuse, or abuse of this product or unauthorized modifications, repairs, or alterations to this product, or (excluding the U.S.) failure to strictly comply with Seiko Epson Corporation's operating and maintenance instructions.

Seiko Epson Corporation shall not be liable for any damages or problems arising from the use of any options or any consumable products other than those designated as Original Epson Products or Epson Approved Products by Seiko Epson Corporation.

Seiko Epson Corporation shall not be held liable for any damage resulting from electromagnetic interference that occurs from the use of any interface cables other than those designated as Epson approved Products by Seiko Epson Corporation.

This information is subject to change without notice.

[A Note Concerning Responsible Use of Copyrighted Materials](#)

[Default Delay Times for Power Management for Epson Products](#)

[Copyright Attribution](#)

Parent topic: [Notices](#)

A Note Concerning Responsible Use of Copyrighted Materials

Epson encourages each user to be responsible and respectful of the copyright laws when using any Epson product. While some countries' laws permit limited copying or reuse of copyrighted material in certain circumstances, those circumstances may not be as broad as some people assume. Contact your legal advisor for any questions regarding copyright law.

Parent topic: [Copyright Notice](#)

Default Delay Times for Power Management for Epson Products

This product will enter sleep mode after a period of nonuse. This is to ensure that the product meets Energy Star standards of energy efficiency. More energy savings can be achieved by setting the time to sleep to a shorter interval.

Parent topic: [Copyright Notice](#)

Copyright Attribution

© 2015 Epson America, Inc.

9/15

CPD-43575

Parent topic: [Copyright Notice](#)